

Indian[®]
MOTORCYCLE

Scout[®]
Scout[®] *Sixty*

2017 RIDER'S MANUAL

California Proposition 65 Warning

This product contains or emits
chemicals known to the state of
California to cause cancer and birth
defects or other reproductive harm.



2017 Rider's Manual

Scout®
Scout® Sixty

Copyright 2016 Indian Motorcycle International, LLC

All information contained within this publication is based on the latest product information available at the time of publication. Product improvements or other changes may result in differences between this manual and the motorcycle. Depictions and/or procedures in this publication are intended for reference use only.

No liability can be accepted for omissions or inaccuracies. Indian Motorcycle Company reserves the right to make changes at any time, without notice and without incurring obligation to make the same or similar changes to motorcycles previously built. Any reprinting or reuse of the depictions and/or procedures contained within, whether whole or in part, is expressly prohibited.

INDIAN®, INDIAN MOTORCYCLE® and INDIAN SCOUT® are trademarks of Indian Motorcycle Company.

Printed in U.S.A.

9927436

CONGRATULATIONS!

Congratulations on your purchase of a new INDIAN motorcycle. You have joined an elite family of motorcycle riders who have acquired a celebrated piece of American history by choosing to own an INDIAN motorcycle.

Your new motorcycle is the end result of true dedication and craftsmanship by our engineering, design and assembly teams. It was designed and manufactured to meet our goal of providing you with a high quality motorcycle that you can ride trouble-free for many years to come. We hope you will take as much pride in riding your new motorcycle as our team did in building it for you.

We urge you to read this rider's manual thoroughly. It contains information essential to safe riding and proper maintenance of your motorcycle.

Your authorized INDIAN MOTORCYCLE dealer knows your motorcycle best and should be consulted for service and assistance. Skilled technicians using advanced equipment and methods are best qualified to perform all major repairs and service your motorcycle may require.

INDIAN motorcycles comply with all federal, state and local safety and emission regulations for the area of intended sale.

SAFETY SYMBOLS AND SIGNAL WORDS

The following signal words and symbols appear throughout this manual. Your safety and the safety of others is involved when these words and symbols are used. Become familiar with their meanings before reading the manual.



The safety alert symbol indicates a potential personal injury hazard.

DANGER

A **DANGER** indicates a hazardous situation that, if not avoided, **will** result in death or serious injury.

WARNING

A **WARNING** indicates a hazardous situation that, if not avoided, **could** result in death or serious injury.

CAUTION

A **CAUTION** indicates a hazardous situation that, if not avoided, could result in minor or moderate injury.

NOTICE

A **NOTICE** indicates a situation that could result in property damage.

NOTE

A **NOTE** indicates information that helps clarify procedures.

Introduction.	7
Safety.	9
Reporting Safety Defects	19
Component Identification	21
Features and Controls	25
Pre-Ride Inspections	41
Operation.	53
Maintenance	65
Cleaning and Storage	107
Specifications	117
Warranty	123
Maintenance Log	135

INTRODUCTION

IDENTIFICATION NUMBER RECORD

RECORD IMPORTANT IDENTIFICATION NUMBERS BELOW.	
Vehicle Identification Number (VIN) (see page 20)	
Engine Identification Number (see page 23)	
Ignition Key Number (see page 23)	

SERVICE AND WARRANTY INFORMATION

Some procedures are beyond the scope of this manual. See your dealer to purchase an *INDIAN MOTORCYCLE Service Manual*. Some procedures provided in the service manual require specialized knowledge, equipment, and training. Be sure you have the required technical skills and tools that are needed before you attempt ANY service on your motorcycle. Please contact your authorized dealer before attempting any service work that is beyond your level of technical knowledge or experience, or if the work requires specialized equipment.

OPERATING YOUR MOTORCYCLE OUTSIDE THE USA

If you plan to operate your motorcycle in countries other than the USA and Canada:

- Service facilities or replacement parts may not be readily available.
- Unleaded gasoline may not be available. The use of leaded fuels will cause engine damage, damage to your emissions systems and voiding of your warranty.
- Gasoline may have a considerably lower octane rating. Improper fuel can cause engine damage.

SAFETY ABOUT THE RIDER'S MANUAL

WARNING! Failure to follow all recommended precautions and procedures could result in severe injury or death. Always heed all safety precautions and follow all operation, inspection and maintenance procedures outlined in this manual.

All references to RIGHT, LEFT, FRONT or REAR are from the operator's perspective when seated in a normal riding position. If you have questions about the operation or maintenance of your motorcycle after you've read this manual, please see your authorized dealer. To locate the nearest authorized INDIAN MOTORCYCLE dealer, visit the INDIAN MOTORCYCLE web site at www.indianmotorcycle.com.

Carefully read and understand the information found in the *Safety* section beginning on this page. To keep your motorcycle in peak condition on the road or in storage, understand and follow the procedures outlined in the *Maintenance* section beginning on page 65.

Bring the manual along when you ride. Following the precautions and procedures in the manual will add to your enjoyment and help keep you safe. If you lose or damage this manual, please purchase a new one through any authorized INDIAN MOTORCYCLE dealer. This rider's manual should be considered part of the motorcycle and should remain with the motorcycle when ownership changes.

SAFETY

SAFE RIDING PRACTICES

WARNING! Improper use of this motorcycle can result in serious injury or death. To minimize the risk, read and understand the information contained in this section before operating the motorcycle. This section contains safety information specific to the INDIAN motorcycle, as well as information about general motorcycle safety. Anyone who rides the motorcycle (operators and passengers) must follow these safety precautions.

MOTORCYCLING HAS INHERENT RISKS

You can minimize those risks, but you can't eliminate them completely. Even if you're an experienced motorcycle operator or passenger, read all of the safety information in this manual before operating the motorcycle.

- Take a rider education course from the Motorcycle Safety Foundation or another qualified instructor. The course will help you develop or refresh your expertise in safe riding habits through instruction and riding. For information on Motorcycle Safety Foundation rider education courses in your area, call 1-800-446-9227 or visit www.msf-usa.org.
- Read and understand all information in this rider's manual.
- Observe all maintenance requirements specified in this manual. See the *INDIAN MOTORCYCLE Service Manual* or an authorized INDIAN MOTORCYCLE dealer.

DESIGN CHARACTERISTICS AFFECT HOW YOU SHOULD RIDE THE MOTORCYCLE

- The motorcycle is designed for on-road use with one rider (and one passenger if the motorcycle is equipped with a passenger seat and pegs). *Never exceed the GVWR or the GAWR.* Refer to page 117, or the Manufacturing Information/VIN label on the motorcycle frame for model-specific information.
- Riding off-road, riding with more than one passenger, or carrying weight exceeding the maximum weight rating can make handling difficult, which could cause loss of control.
- During the first 500 miles (800 km) of operation, follow all break-in procedures as outlined on page 53. Failure to do so can result in serious engine damage.
- If your motorcycle is equipped with saddlebags, a windshield or a passenger backrest, be prepared to reduce operating speed to maintain stability.

FOLLOW THESE GENERAL SAFE RIDING PRACTICES

- Before each ride, perform the pre-ride inspections. Failure to do so may result in damage to the motorcycle or an accident.
 - Until you're thoroughly familiar with the motorcycle and all of its controls, practice riding where there is little or no traffic. Practice riding at a moderate speed on various road surfaces and in different weather conditions.
 - Know your skills and limits, and ride within them.
 - Allow only licensed, experienced operators to ride your motorcycle, and then only after they have become familiar with its controls and operation. Make sure all riders read and understand this rider's manual before riding.
 - Do not ride when you're fatigued, ill or under the influence of alcohol, prescription drugs, over-the-counter drugs or any other drugs. Fatigue, illness, alcohol and drugs can cause drowsiness, loss of coordination and loss of balance. They can also affect your awareness and judgment.
 - If your motorcycle operates abnormally, correct the problem immediately. See the *INDIAN MOTORCYCLE Service Manual* or an authorized INDIAN MOTORCYCLE dealer or other qualified dealer.
 - Ride defensively, as if you are invisible to other motorists, even in broad daylight. *A motorist's failure to see or recognize a motorcycle is the leading cause of automobile/motorcycle accidents.* Ride where you're clearly visible to other motorists, and observe their behavior carefully.
 - Be especially cautious at intersections, as these are the most likely places for an accident.
 - To prevent loss of control, keep your hands on the handlebars and your feet on the footrests.
 - Be aware that a highway bar is not designed to protect the rider from injury in a collision.
 - Obey the speed limit and adjust your speed and riding technique based on road, weather and traffic conditions. As you travel faster, the influence of all other conditions increases, which can affect the motorcycle's stability and increase the possibility of losing control.
 - Do not move or operate the motorcycle with the steering locked (if equipped), as the severely restricted steering could result in loss of control.
 - Reduce speed when:
 - The road has potholes or is otherwise rough or uneven.
 - The road contains sand, dirt, gravel or other loose substances.
 - The road is wet, icy or oily.
 - The road contains painted surfaces, manhole covers, metal grating, railway crossings or other slippery surfaces.
 - The weather is windy, rainy or otherwise causing slippery or rapidly changing conditions.
 - Traffic is heavy, congested, not allowing sufficient space between vehicles or otherwise not flowing smoothly.
 - You are being passed in either direction by a large vehicle that may produce a wind blast in its wake.
 - When approaching a curve, choose a speed and lean angle that allows you to pass through the curve in your own lane without applying the brakes. Excessive speed, improper lean angle or braking in a curve can cause loss of control.
 - Ground clearance is reduced when the motorcycle leans. Do not allow components to contact the road surface when leaning the motorcycle in a curve, as this could cause loss of control.
-

SAFETY

- Do not tow a trailer. Towing a trailer can make the motorcycle hard to handle.
- Retract the sidestand fully before riding. If the sidestand is not fully retracted, it could contact the road surface and cause loss of control.
- To maximize braking effectiveness, use the front and rear brakes together. Be aware of the following braking facts and practices:
 - The rear brake provides 40% of the motorcycle's stopping power, at most. Use the front and rear brakes together.
 - To avoid skidding, apply the brakes gradually when the road is wet or rough, or contains loose or other slippery substances.
 - If possible, avoid applying the brakes while making a turn. Motorcycle tires have less traction during turns, so braking will increase the possibility of skidding. Bring the motorcycle to the upright position before applying the brakes.
 - With new pads and rotors, allow up to 250 miles (500 km) of operation in urban driving conditions (not highway cruising) to allow pads to mate with new rotors. Brakes should be used frequently. During this time brake performance will be less effective. Avoid using brakes harshly unless in an emergency. Brake efficiency will gradually increase during this seating period.

ANTI-LOCK BRAKE SYSTEM RESPONSE (IF EQUIPPED)

When the anti-lock brakes engage during a braking event, the rider will feel pulsing at the brake levers. *Continue to apply steady pressure to the brakes for the best stopping performance.*

CARRYING A PASSENGER

WARNING! Do not carry a passenger unless the motorcycle is equipped with passenger seat and passenger footrests.

TO CARRY A PASSENGER SAFELY

- Do not exceed the gross vehicle weight rating (GVWR) for your motorcycle. Refer to the *Specifications* section of this manual (page 117) or the Manufacturing Information/VIN label on the motorcycle frame for model-specific information.
- Direct the passenger to hold onto you or to the passenger hand strap with both hands and to keep both feet on the passenger footrests. Do not carry a passenger who cannot place both feet firmly on the passenger footrests. A passenger who is not holding on properly, or who cannot reach the passenger footrests, can shift their body erratically, which can make the motorcycle hard to handle and cause loss of control.
- Before riding, be sure your passenger knows safe riding procedures. Discuss any safety information unfamiliar to your passenger. A passenger who is unaware of safe riding procedures may distract you or make movements that make the motorcycle hard to handle.
- Adjust your riding style to compensate for the differences in handling, acceleration and braking caused by the additional weight of the passenger. Failure to do so can cause loss of control.
- For riding comfort and to ensure proper ground clearance, adjust rear shock preload.

SAFETY

PROTECTIVE APPAREL

Wear protective apparel to decrease the risk of injury and increase riding comfort.

- Always wear a helmet that meets or exceeds established safety standards. Approved helmets in the USA and Canada bear a U.S. Department of Transportation (DOT) label. Laws in some areas *require* that you wear an approved helmet. Head injuries are the leading cause of fatalities in accidents involving motorcycles. Statistics prove that an approved helmet is the most effective protection in preventing or reducing head injuries.
- Wear eye protection to protect eyes from wind or airborne particles and objects. Laws in some areas *require* that you wear eye protection. We recommend that you wear approved Personal Protective Equipment (PPE) bearing markings such as VESC 8, V-8, Z87.1, or CE. Make sure protective eyewear is kept clean.
- All riders should wear bright or light-colored and/or reflective clothing to improve visibility to other motorists. *A motorist's failure to see or recognize a motorcycle is the leading cause of automobile/motorcycle accidents.*
- Wear gloves, a jacket, heavy boots and long pants to prevent or reduce injury from abrasions, lacerations or burns should the motorcycle fall. Wear boots with low heels, as high heels can catch on pedals or footrests. The combination of boots and pants should completely cover legs, ankles and feet, protecting skin from engine and exhaust system heat.
- Do not wear loose, flowing clothing or long boot laces, as they can catch on handlebars, levers or footrests, or they can become entangled in the wheels, causing loss of control and serious injury.

USE OF ACCESSORIES

Because INDIAN MOTORCYCLE cannot test and make specific recommendations concerning every accessory or combination of accessories sold, the operator is responsible for determining that the motorcycle can be safely operated with any accessories or additional weight. Use the following guidelines when choosing and installing accessories:

- Do not install accessories that impair operator visibility or the stability, handling or operation of the motorcycle. Before installing an accessory, be sure that it does not:
 - reduce ground clearance when the motorcycle is either leaned or in a vertical position;
 - limit suspension or steering travel or your ability to operate controls;
 - displace you from your normal riding position;
 - obscure lights or reflectors.
- Bulky, heavy or large accessories can cause instability (due to the lifting or buffeting effects of wind) and loss of control.
- Do not install electrical accessories that exceed the capacity of the motorcycle's electrical system. Never install higher wattage light bulbs than those supplied as original equipment. An electrical failure could result and cause hazardous loss of engine power or lights, or damage to the electrical system. See page 101.
- Use only genuine INDIAN MOTORCYCLE accessories designed for your model.
- Do not exceed the gross vehicle weight rating (GVWR) for your motorcycle.

MODIFICATIONS

Modifying the motorcycle by removing any equipment or by adding equipment not approved by the manufacturer may void your warranty. Such modifications could make the motorcycle unsafe to ride and could result in severe injury to operator or passenger, as well as damage to the motorcycle. Some modifications may not be legal in your area of operation. If in doubt, contact your authorized INDIAN MOTORCYCLE dealer.

PARKING THE MOTORCYCLE

When leaving the motorcycle unattended, turn the engine off. Remove the ignition key to prevent unauthorized use.

Park the motorcycle where people are not likely to touch the hot engine or exhaust system or place combustible materials near these hot areas. Do not park near a flammable source such as a kerosene heater or an open flame, where hot components could ignite combustible materials.

Park the motorcycle on a firm, level surface. Sloped or soft surfaces may not support the motorcycle. If you must park on a slope or soft surface, follow the precautions outlined on page 63.

SADDLEBAGS

Whenever operating with saddlebags or while carrying cargo:

- Never ride at excessive speeds. Saddlebags and cargo, combined with the lifting or buffeting effects of wind, can make the motorcycle unstable and cause loss of control.
- Distribute weight evenly on each side of the motorcycle.
- Do not exceed the individual weight limit of each saddlebag.
- NEVER EXCEED GROSS VEHICLE WEIGHT RATING (GVWR) or the GROSS AXLE WEIGHT RATING (GAWR), regardless of whether or not the saddlebags are loaded to capacity. Exceeding the weight rating can reduce stability and handling and cause loss of control.

SAFETY

CARRYING CARGO

Use the following guidelines when attaching cargo or accessories to the motorcycle. Where applicable, these guidelines also refer to the contents of any accessories.

- Keep cargo and accessory weight to a minimum, and keep items as close to the motorcycle as possible to minimize a change in the motorcycle's center of gravity. Changing the center of gravity can cause loss of stability and handling and could cause loss of control.
- Do not exceed the gross vehicle weight rating (GVWR) for your motorcycle.
- Distribute weight evenly on both sides of the motorcycle. Maintain even weight distribution by checking accessories and cargo to make sure they're securely attached to the motorcycle before riding and whenever you take a break from riding. Uneven weight distribution or sudden shifting of accessories or cargo while you're riding may cause difficult handling, loss of control and driving hazards for other motorists (if cargo falls from the motorcycle).
- For riding comfort and to ensure proper ground clearance, adjust rear shock preload. See page 80.
- Do not attach large or heavy cargo such as sleeping bags, duffle bags or tents to the handlebars, front fork area or front fender. Cargo or accessories placed in these areas can cause instability (due to improper weight distribution or aerodynamic changes) and could cause loss of control.
- Do not exceed the maximum cargo weight limit of any accessory (see accessory instructions and labels). Do not attach cargo to an accessory not designed for that purpose. Either circumstance could result in an accessory failure that could cause loss of control.
- Always obey posted speed limits.
- Do not attach anything to the motorcycle unless specifically designed for that purpose by INDIAN MOTORCYCLE.

TRANSPORTING THE MOTORCYCLE

If you must transport the motorcycle:

- Use a truck or trailer. Do not tow the motorcycle with another vehicle, as towing will impair the motorcycle's steering and handling.
- Position and restrain the motorcycle in an upright position. If the motorcycle leans to one side, gasoline may leak from the fuel tank and result in a fire hazard or damage to the finish.
- Do not restrain the motorcycle using the handlebars.
- Loop tiedown straps (from the front) up and over the lower triple clamp, using care to not interfere with wiring and brake lines. Place tiedowns as wide apart as possible on the truck or trailer bed for best stability.

FUEL AND EXHAUST SAFETY

Always heed these fuel safety warnings when refueling or servicing the fuel system. For fueling procedures, see page 55.

WARNING! Gasoline is highly flammable and explosive under certain conditions.

- Always exercise extreme caution whenever handling gasoline.
- Always turn off the engine before refueling.
- Always refuel outdoors or in a well-ventilated area.
- Open the fuel cap slowly. Do not overfill the tank. Do not fill the tank neck.
- Do not smoke or allow open flames or sparks in or near the area where refueling is performed or where gasoline is stored.

Gasoline and gasoline vapors are poisonous and can cause severe injury.

- Do not swallow gasoline, inhale gasoline vapors, or spill gasoline. If you swallow gasoline, inhale more than a few breaths of gasoline vapor, or get gasoline in your eyes, see a physician immediately.
 - If gasoline spills on your skin or clothing, immediately wash it off with soap and water and change clothing.
 - Exhaust gases contain carbon monoxide, a colorless, odorless gas that can cause loss of consciousness or death in a short time.
 - Never start the engine or let it run in an enclosed area.
 - Never inhale exhaust gases.
-

SAFETY

SAFETY MAINTENANCE

WARNING! Failure to perform safety maintenance as recommended can result in difficult handling and loss of control, which could result in serious injury or death. Always perform the safety maintenance procedures as recommended in this manual. Perform maintenance and repairs promptly. See the INDIAN MOTORCYCLE Service Manual or an authorized INDIAN MOTORCYCLE dealer or other qualified dealer.

- Before each ride, perform the *Pre-Ride Inspections*.
- Perform all periodic maintenance at the recommended intervals outlined in the *Periodic Maintenance* section.
- Always maintain proper tire pressure, tread condition and wheel and tire balance. Inspect tires regularly and replace worn or damaged tires promptly. Use only approved replacement tires. See the *Specifications* section.

Always ensure proper steering head bearing adjustment. Regularly inspect the rear shock absorber and the front forks for fluid leaks or damage. Make any necessary repairs promptly. See page 83.

- Clean the motorcycle thoroughly to reveal items in need of repair.
- Fasteners must meet original specifications for quality, finish and type to ensure safety. Use only genuine INDIAN MOTORCYCLE replacement parts, and ensure that all fasteners are tightened to the proper torque.

ELECTROMAGNETIC INTERFERENCE

This vehicle complies with UNECE Regulation No. 10 requirements, which is equivalent to Canadian ICES-002.

GROSS VEHICLE WEIGHT RATING (GVWR)

WARNING! Exceeding the gross vehicle weight rating of your motorcycle can reduce stability and handling and could cause loss of control. NEVER exceed the GVWR of your motorcycle.

The *maximum load capacity* of your motorcycle is the maximum weight you may add to your motorcycle *without exceeding the GVWR*. This capacity is determined by calculating the difference between your motorcycle's GVWR and wet weight.

Refer to the *Specifications* section of this manual (page 117) or the Manufacturing Information/VIN label on the motorcycle frame for model-specific information.

When determining the weight you will be adding to your motorcycle, and to ensure you do not exceed the maximum load capacity, include the following:

- operator body weight
- passenger body weight
- weight of all riders' apparel and items in or on apparel
- weight of any post-production accessories *and their contents*
- weight of any additional cargo on the motorcycle

REPORTING SAFETY DEFECTS

If you believe that your vehicle has a defect that could result in a crash or cause injury or death, you should immediately inform the National Highway Traffic Safety Administration (NHTSA) in addition to notifying INDIAN MOTORCYCLE in writing.

If NHTSA receives similar complaints, it may open an investigation, and if it finds that a safety defect exists in a group of vehicles, it may order a recall and remedy campaign. However, NHTSA cannot become involved in individual problems between you, your INDIAN MOTORCYCLE dealer or Indian Motorcycle Company.

To contact NHTSA, or obtain other information about motor vehicle safety, you may either call the Vehicle Safety Hotline toll-free at 1-888-327-4236 (TTY: 1-800-424-9153), visit the NHTSA web site at www.safercar.gov, or write to:

ADMINISTRATOR, NHTSA
1200 New Jersey Avenue, SE
West Building
Washington, DC 20590

SAFETY

SAFETY AND INFORMATION LABELS

Labels are model-specific and market-specific. Your motorcycle may not contain all of the labels shown.

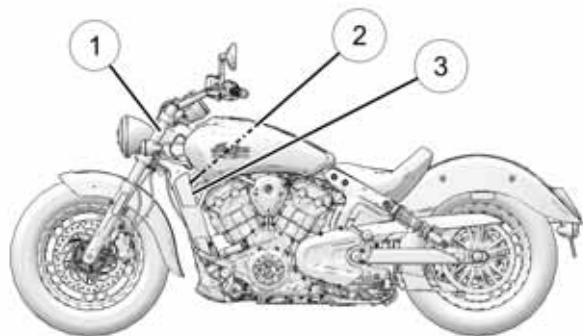

1. Vehicle Identification Number (VIN) (on side of steering head)
2. Vehicle Emission Control Information (VECI)

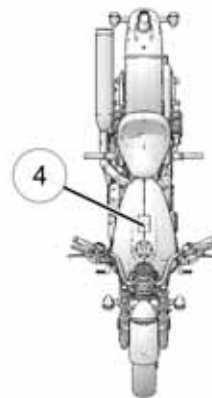

3. Noise Emission Control Information (NECI)
4. Operator Warning/Fuel Recommendation

COMPONENT IDENTIFICATION

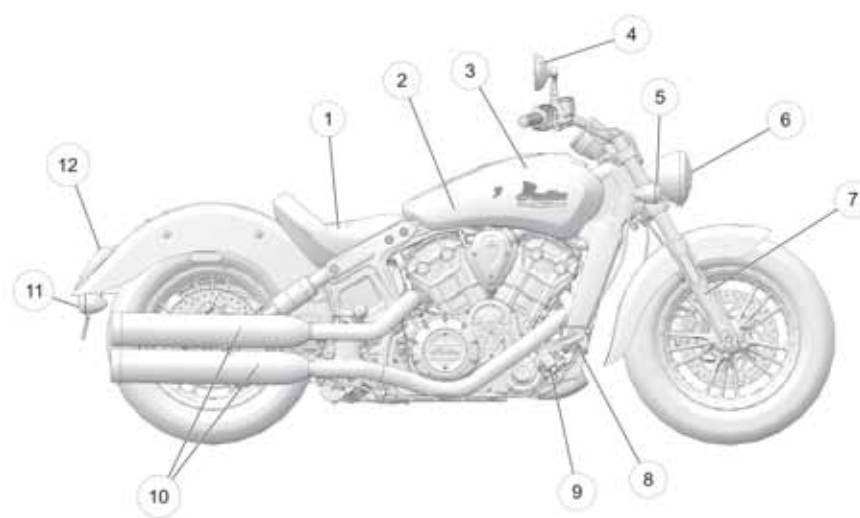

1. Driver's Seat

2. Air Box (under fuel tank)

3. Fuel Tank

4. Mirror

5. Right Front Turn Signal

6. Headlight

7. Front Fork

8. Rear Brake Pedal

9. Driver's Footrest

10. Mufflers

11. Right Rear Turn Signal

12. Taillight

COMPONENT IDENTIFICATION

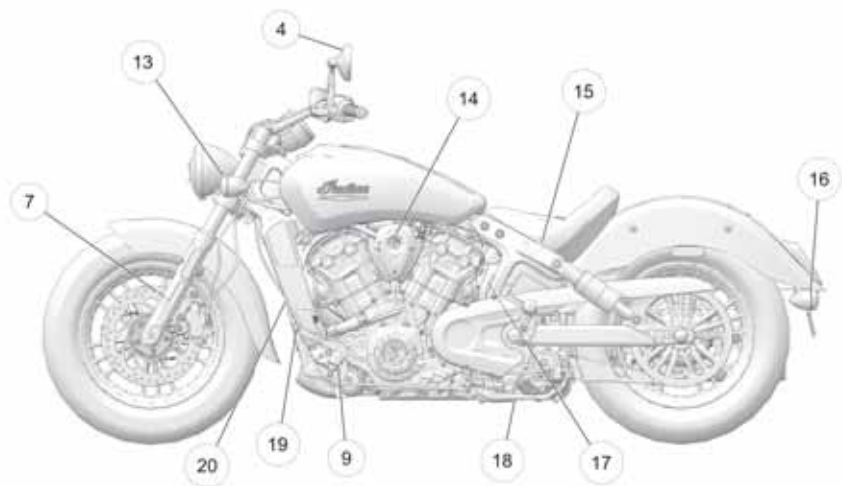

- 13. Left Front Turn Signal
- 14. Ignition Switch
- 15. Battery (under seat)

- 16. Left Rear Turn Signal
- 17. Coolant Recovery Bottle
- 18. Sidestand

- 19. Gear Shifter
- 20. Radiator

ENGINE IDENTIFICATION NUMBER

The engine number Q is stamped into the bottom of the left crankcase near the sidestand..

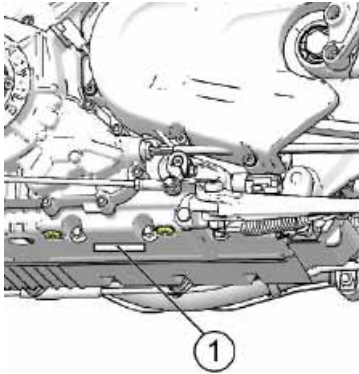

INDIAN SCOUT shown

KEY IDENTIFICATION NUMBER

The key identification number Q is stamped on the metal key tag attached to the key ring. If it becomes necessary to replace the ignition key for any reason, provide the key number to your INDIAN dealer.

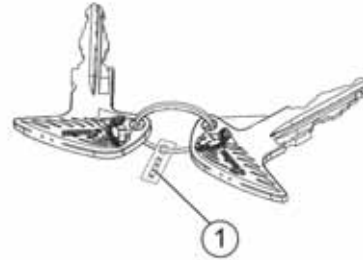

COMPONENT IDENTIFICATION

CONSOLE

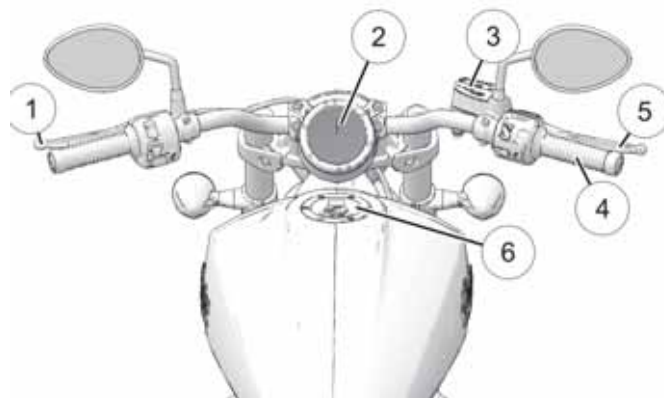

1. Clutch Lever

2. Instrument Cluster

3. Front Brake Master Cylinder

4. Throttle Control Grip

5. Front Brake Lever

6. Fuel Cap

FEATURES AND CONTROLS SWITCH LOCATIONS

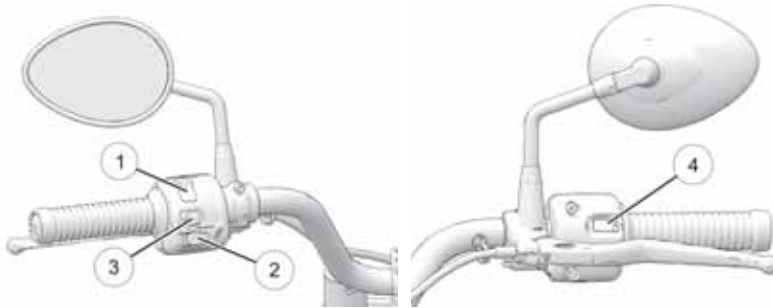

Left Control

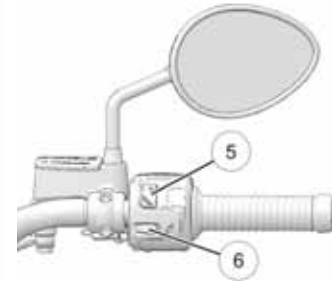







Right Control

Left Control		Right Control	
q	High/Low Light Switch	t	Engine Stop/Run Switch
w	Horn Switch	y	Engine Start Switch
e	Turn Signal Switch/Hazard Warning Flashers Switch		
r	Mode Button		

FEATURES AND CONTROLS

SWITCH SYMBOLS

SYMBOL	SWITCH	DESCRIPTION
	Hazard Warning Flashers Switch	The hazard warning flashers switch activates and cancels the hazard warning flashers. See previous page.
	High/Low Headlight Beam Switch	The high/low headlight beam switch toggles the headlight between high beam and low beam. See previous page.
	Horn Switch	To sound the horn, press the horn switch.
	Turn Signal Switch	Move the switch to the left to activate the left turn signals. Move the switch to the right to activate the right turn signals. A signal will deactivate automatically when speed or distance reach predetermined levels. To cancel a signal manually, move the switch to the center position and push it inward. Momentary Feature: Move the turn signal switch left or right and hold it in that position for at least one second. The momentary feature will activate and the signal will then cancel when the switch is released. If a bulb fails, the lamp flashes at more than twice the normal rate.
	Stop/Run Switch	Press the bottom of the switch (RUN) to allow the engine to start and run. Press the top of the switch (STOP) to stop the engine. See previous page.
	Starter Switch	Use the starter switch to start the engine. The engine stop/run switch must be in the RUN position. See previous page.

SWITCH FUNCTIONS

HAZARD WARNING FLASHERS SWITCH

The ignition switch must be in the ON position to activate the hazard warning flashers, but once activated, the hazard warning flashers will continue to flash when the ignition switch is turned off. When the hazard warning flashers are active, all four turn signals flash.

- Press and hold the hazard warning flashers switch for 1-2 seconds to activate the hazard warning flashers.
- Press and release the switch to cancel the hazard warning flashers.

MODE BUTTON



The MODE button  is located on the front side of the left handlebar controls. With the ignition switch on, use the MODE button to toggle through the modes of the multi-function display.

Use the MODE button to set the display units to either standard or metric units of measurement. See page 33.



ENGINE STOP/RUN SWITCH

Use the engine stop/run switch to turn the engine off quickly. Turn the key off after the engine stops.

- Press the top of the switch (STOP)  to interrupt the circuits and stop the engine. The engine should not start or run when the switch is in the STOP position.
- Press the bottom of the switch (RUN)  to complete the circuits and allow the engine to start and run.

TIP: The headlights and any accessories plugged into power ports will remain on until the ignition key is turned off.

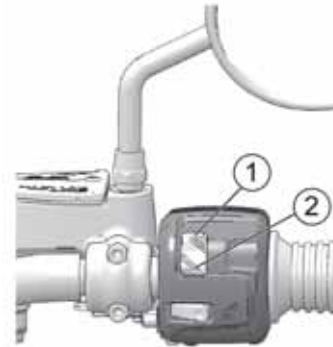

FEATURES AND CONTROLS

ENGINE STARTER SWITCH

Read the engine starting procedures before starting the engine. See page 54.

Press and release the starter switch Q to start the engine. The engine stop/run switch must be in the RUN position and the transmission must be in neutral, or the clutch must be disengaged.



HIGH/LOW HEADLIGHT BEAM SWITCH

The high/low headlight beam switch Q toggles the headlight between high beam and low beam. To activate the high beam, press the upper portion of the switch. To activate the low beam, press the lower portion of the switch.

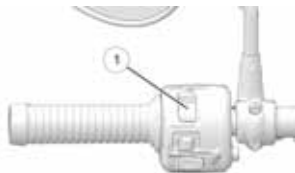



IGNITION/LIGHT KEY SWITCH

Motorcycle riders must remain as visible as possible at all times. To aid in this, the headlight must be on at all times while operating. The headlights automatically operate when the engine is running. Do not modify the ignition/light switch wiring to circumvent the automatic headlight feature.

The ignition/light key switch  controls the electrical functions of the motorcycle. The switch is located on the ignition cover on the left side of the motorcycle.

Before starting the engine , read the instructions for starting the engine. See page 57.

Turn the ignition switch to the OFF  position and remove the ignition key when leaving the motorcycle unattended.

Push the key into the ignition switch while turning it to the PARK position . In PARK, the taillight, indicator lights and license plate

light illuminate. Vehicle powered accessories (if equipped) can be operated and the instrumentation is active. The ignition key can be removed.

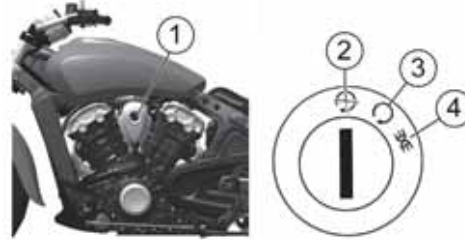

FEATURES AND CONTROLS

INSTRUMENT CLUSTER

The instrument cluster includes the speedometer, indicator lamps and Multi-Function Display (MFD).



q Speedometer







w Indicator Lamps

e MFD



SPEEDOMETER

The speedometer displays forward vehicle speed in either miles per hour or kilometers per hour.

INDICATOR LAMPS



LAMP	INDICATES	CONDITION
	Chassis Fault	The alert symbol illuminates if a chassis fault occurs.
	Low Fuel	This lamp illuminates when about 1/2 gallon (1.9 L) of fuel remains in the tank.
	Neutral	This lamp illuminates when the transmission is in neutral.
	High Beam	The lamp illuminates when the headlight switch is set to high beam.
	Turn Signal	The turn signal indicator flashes when the left, right, or both turn signals (hazard) are active. If there is a problem in the signal system, the lamps will flash at twice the normal rate.
	ABS Not Activated (if equipped)	The indicator remains on until the ABS activates, which occurs when vehicle speed exceeds 6 MPH (10 km/h). When the lamp is illuminated, the anti-lock brakes will not activate, but the conventional brake system will continue to operate normally.
	Check Engine	<i>If this lamp illuminates while the engine is running, see your dealer promptly.</i> The light will remain on if the tilt sensor shuts down the engine. If abnormal sensor or engine operation is detected the light will remain on as long as the fault condition exists. Retrieve the error codes for diagnosis. See page 35.

FEATURES AND CONTROLS

LAMP	INDICATES	CONDITION
	Sidestand Light (if equipped)	The sidestand light will turn on anytime the sidestand is down.
	Vehicle Speed	When standard mode is selected, speed displays in miles per hour.
		When metric mode is selected, speed displays in kilometers per hour.

MULTI-FUNCTION DISPLAY (MFD)

MFD INDICATORS

LAMP	INDICATES	CONDITION
	Low Oil Pressure	This lamp illuminates when oil pressure drops below a safe operating pressure while the engine is running. If this lamp illuminates while the engine is running above idle speed, turn the engine off as soon as safely possible and check the oil level. <i>If the oil level is correct and the lamp remains on after the engine is restarted, turn the engine off immediately. See your dealer.</i>
	Low Battery Voltage	This lamp illuminates when battery voltage is low. Turn non-essential accessories off to conserve power. Make sure the charging system is operating properly. See page 105.

MULTI-FUNCTION DISPLAY MODES

With the ignition switch on, use the MODE button ① to toggle through the modes of the multi-function display and to change settings in the display.



MODES AVAILABLE	
Odometer	Engine Coolant Temperature
Trip Odometer	Gear Indicator
Engine Speed	Clock

ODOMETER

The odometer displays total distance traveled.

TRIP ODOMETER

The trip odometer displays total distance traveled since being reset. To reset, toggle to the trip odometer, then press and hold the MODE button until the trip odometer resets to zero.

ENGINE SPEED

Engine speed displays in revolutions per minute (RPM).

ENGINE COOLANT TEMPERATURE

The temperature area displays the temperature of the engine coolant.

GEAR INDICATOR

Gear position will display when the transmission is in gear if the motorcycle is moving with the clutch lever released. It will also display when the transmission is in neutral.

FEATURES AND CONTROLS

CLOCK

TIP: The clock must be reset any time the battery has been disconnected or discharged.

1. Use the MODE button to toggle to the odometer display.
2. Press and *hold* the MODE button until the hour segment flashes. Release the switch.
3. With the segment flashing, tap the MODE button to advance to the desired setting.
4. Press and *hold* the MODE button until the next segment flashes. Release the switch.
5. Repeat steps 3– 4 twice to set the 10-minute and 1-minute segments. After completing the 1-minute segment, step 4 will save the new settings and exit the clock mode.

DIAGNOSTIC FUNCTIONALITY

Certain conditions will cause the battery indicator to illuminate and an error message to display in the screen. If this occurs, please see your authorized dealer.

MES-SAGE	LOCATION	INDICATES
LO	DC Voltage Screen	Voltage remains below 11.0 volts for more than 10 seconds
OV	DC Voltage Screen	Voltage remains above 15.0 volts for more than 10 seconds
ERROR	All	Checksum error (gauge malfunction)

DISPLAY UNITS (STANDARD/METRIC)

The display can be changed to display either standard or metric units of measurement.

	STANDARD DISPLAY	METRIC DISPLAY
Distance	Miles	Kilometers
Temperature	Fahrenheit	Celsius
Time	12-Hour Clock	24-Hour Clock

1. Turn the ignition off.
2. Wait 10 seconds.
3. Press and *hold* the MODE button while turning the key to the ON or PARK position.
4. When the display flashes the distance setting, tap the MODE button to advance to the desired setting.
5. Press and *hold* the MODE button to save the setting and advance to the next display option.
6. Repeat the procedure to change remaining display settings.

ENGINE ERROR CODES

The error screen displays only when the CHECK ENGINE light is on or when it goes on and off during one ignition cycle. Error codes display only during the current ignition cycle. When the ignition switch is turned OFF, the code and message is lost, but will reappear if the fault reoccurs after restarting the engine.

If the CHECK ENGINE indicator lamp illuminates, retrieve the error codes from the display.

1. If the error codes are not displayed, use the MODE button to toggle until "Ck ENG" displays on the main line of the display.
2. Press and hold the MODE button to enter the diagnostics code menu.
3. Record the three numbers displayed in the gear position, clock and odometer displays.
4. See an authorized dealer for code details and diagnosis.

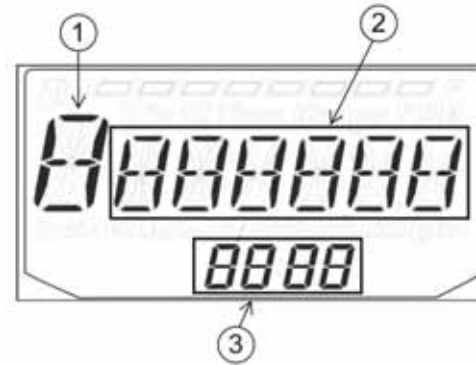

Q Error Code Number (0-9)

⊖ Failure Mode Indicator (FMI)

W Suspect Parameter Number (SPN)

FEATURES AND CONTROLS

OVER TEMPERATURE DISPLAY AND WARNING INDICATOR

“HO” displays and the CHECK ENGINE indicator lamp illuminates under the following conditions.



CONDITION	INDICATES	ACTION REQUIRED
Engine coolant temperature approaches unsafe operating condition while the engine is running.	Engine coolant temperature is above a safe operating temperature.	Stop the engine as soon as safely possible. Check the coolant level. Check the radiator for debris. Check cooling fan operation. If the warning continues to display after restarting the engine, stop the engine immediately.

THROTTLE CONTROL GRIP

The throttle control grip is located on the right handlebar. Use the throttle control grip to control engine speed.

While seated in the proper riding position:

- Roll the grip rearward \curvearrowright to open the throttle (increase engine speed and power).
- Roll the grip forward \curvearrowleft to close the throttle (decrease engine speed and power).

The control grip is spring loaded. When you release the grip, the throttle returns to the idle position.

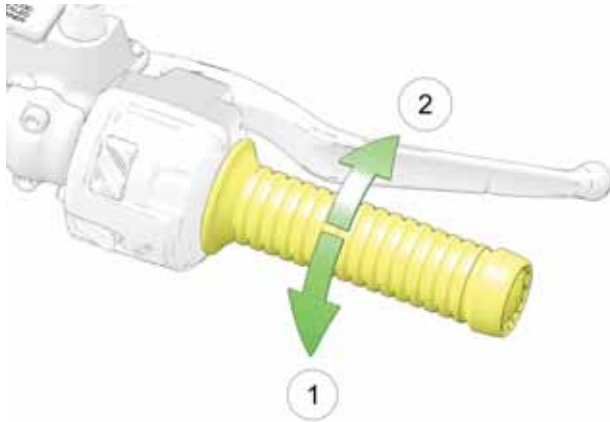

CLUTCH LEVER

The clutch lever \mathcal{C} is located on the left handlebar. Disengage the clutch before shifting gears. For smooth clutch operation, pull the lever quickly and release it in a brisk but controlled manner.

- To disengage the clutch, pull the lever toward the handlebar.
- To engage the clutch, release the lever in a brisk but controlled manner.



MIRRORS

Your vehicle is equipped with convex mirrors. Objects seen in a mirror may be closer than they appear. Always adjust mirrors before riding.

To adjust the mirrors, sit on the motorcycle in the anticipated riding position. Adjust the mirrors so that you can see a small portion of your shoulders in each mirror.

FEATURES AND CONTROLS

GEAR SHIFT LEVER

The gear shift lever **Q** is located on the left side of the motorcycle. Operate the lever with your foot.

- Press downward on the toe lever to shift to a lower gear.
- Lift upward on the toe lever to shift to a higher gear.
- Release the lever after each gear shift.
- See page 59 for gear shifting procedures.

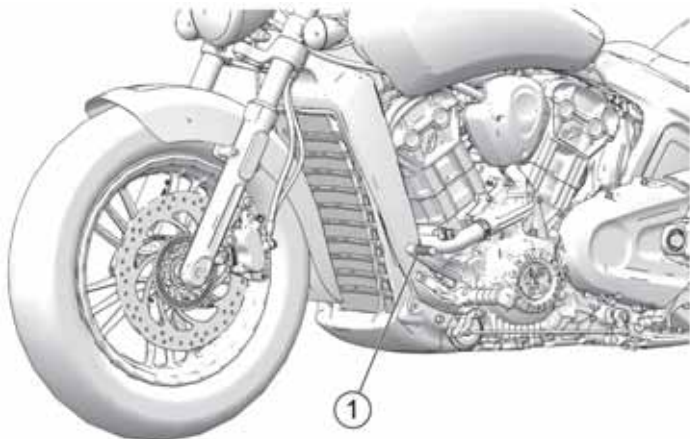

SIDESTAND

WARNING! An improperly retracted sidestand could contact the ground and cause a loss of control resulting in serious injury or death. Always retract the sidestand fully before operating the motorcycle.

To park the motorcycle, swing the end of the sidestand downward and away from the motorcycle until it is fully extended. Always turn the handlebars to the left for maximum stability. Lean the motorcycle to the left until the sidestand firmly supports the motorcycle.

CAUTION! If the motorcycle weight is not resting on the sidestand, it will not lock. In this situation, any movement of the motorcycle could cause the sidestand to retract slightly. If the sidestand is not in the full forward position when the motorcycle weight is rested on it, the motorcycle could fall over, possibly causing injury and damage to the motorcycle.

To retract the sidestand, straddle the motorcycle and bring it to the fully upright position. Swing the end of the sidestand upward and toward the motorcycle until it is fully retracted.

See page 63 for parking instructions, including parking on slopes and soft surfaces.

BRAKES

ANTI-LOCK BRAKE SYSTEM (ABS) (IF EQUIPPED)

The anti-lock brake system automatically reduces or increases brake pressure as needed to provide optimum braking control, reducing the chance of wheel lock-up during hard braking events or when braking on rough, uneven, slippery or loose surfaces. See the Safe Riding Practices starting page 10.

1. The anti-lock brake system cannot be turned off.
 2. The ABS indicator always illuminates when vehicle power is turned on. It remains illuminated until the anti-lock system activates, which occurs when vehicle speed exceeds 6 MPH (10 km/h).
 3. When the lamp is illuminated, the anti-lock brakes will not activate, but the conventional brake system will continue to operate normally.
 4. When the anti-lock brakes engage during a braking event, the rider will feel pulsing at the brake levers. *Continue to apply steady pressure to the brakes for the best stopping performance.*
 5. If the ABS light does not come on when the key is turned to the ON or PARK position, see your authorized INDIAN MOTORCYCLE dealer for service.
- If the lamp continues to illuminate after vehicle speed exceeds 6 MPH (10 km/h), the ABS system is not functioning. See your INDIAN MOTORCYCLE dealer promptly for service.
 - Operating with non-recommended tires or improper tire pressure may reduce the effectiveness of the anti-lock brake system. Always use the recommended size and type of tires specified for your vehicle. Always maintain the recommended tire pressure.
 - The anti-lock brake system will not prevent wheel lockup, loss of traction or loss of control *under all conditions*. Always adhere to all safe motorcycle-riding practices as recommended.
 - It is not unusual to leave tire marks on the road surface during a hard braking event.
 - The anti-lock brake system does not compensate for or reduce the risks associated with:
 - excessive speed
 - reduced traction on rough, uneven or loose surfaces
 - poor judgment
 - improper operation

FEATURES AND CONTROLS

FRONT BRAKE LEVER

The front brake lever ① is located on the right handlebar. This lever controls only the front brakes. The front brakes should be applied simultaneously with the rear brakes. To apply the front brake, pull the lever toward the handlebar. See page 62 for braking procedures.

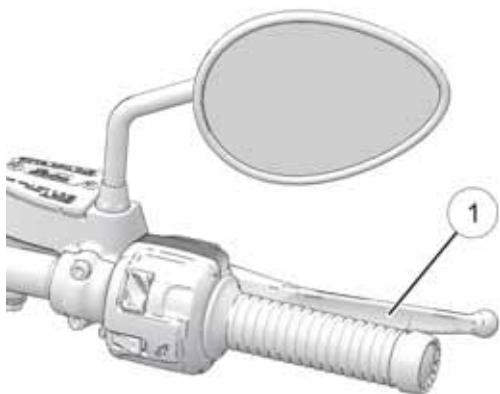

REAR BRAKE PEDAL

The rear brake pedal ① is located on the right side of the motorcycle. Press downward on the rear brake pedal to apply the rear brake.

WARNING! Resting your foot on the brake pedal will cause excessive and premature wear of brake pads and reduced braking efficiency, which could result in severe injury or death.

See page 62 for braking procedures.

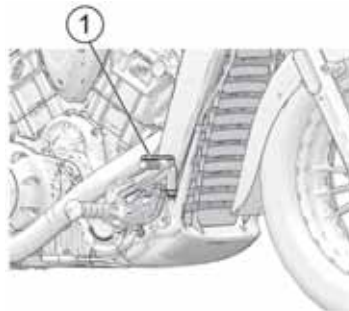

PRE-RIDE INSPECTIONS

To keep your motorcycle in safe operating condition, always perform the recommended pre-ride inspections before each ride. This is especially important before making a long trip and when removing the motorcycle from storage.

WARNING! Failure to perform the recommended pre-ride inspections could result in component failure while riding, which could result in serious injury or death. Always perform the pre-ride inspections before each ride. When inspection reveals the need for adjustment, replacement or repair, perform the service promptly, or see your authorized INDIAN MOTORCYCLE dealer or other qualified dealer for service.

WARNING! Read the entire Instruments, Features and Controls section of this manual before riding your motorcycle. A complete understanding of the features and capabilities of your motorcycle is essential to its safe operation. Anything less may result in serious injury or death.

You must be familiar with all instruments and controls to perform the pre-ride inspections.

TIP: During the pre-ride inspections you may use products that are potentially hazardous, such as oil or brake fluid. When using any of these products, always follow the instructions and warnings on the product packaging.

When inspections reveal the need for adjustment, replacement or repair:

- refer to the maintenance section of this manual
- refer to the INDIAN MOTORCYCLE Service Manual
- or see your authorized INDIAN MOTORCYCLE dealer or other qualified dealer

PRE-RIDE INSPECTIONS

ELECTRICAL INSPECTIONS

Turn the ignition key to the ON position and move the stop/run switch to RUN before performing the following electrical inspections. Return the ignition key to the OFF position after completing these inspections. If inspection of any electrical item reveals component failure, repair or replace the component before operating the motorcycle.

ITEM	INSPECTION PROCEDURE
Headlamp	The headlights automatically operate when the engine is running. Start the engine. Switch to high beam. Verify that the high beam indicator comes on and that lamp brightness increases.
Taillight/Brakelight	Verify that the taillight and license plate light illuminate. Verify that the taillight lamps increase in brightness when the front brake lever is applied and also when the rear brake pedal is applied.
Turn Signals	Move the turn signal switch to the left. Verify that front and rear left turn signals flash, as well as the corresponding light on the indicator panel. Move the switch to the center position and push it inward to cancel the signal. Verify that the signals and the indicator light stop flashing. Repeat the procedure for the right turn signals.
Hazard Warning Flashers	Press and hold the hazard warning flashers switch for 1-2 seconds to activate the hazard warning flashers. Verify that all four turn signals flash, as well as the lamps on the indicator panel. Turn the hazard warning flashers off. Verify that all signals and indicator lamps stop flashing.
Horn	Press the horn switch. Verify that the horn sounds loudly.
Neutral Indicator	Place the transmission in neutral. Verify that the neutral indicator lamp illuminates and that the letter "N" displays in the gear position display.
Low Oil Pressure Indicator	Start the engine. Verify that the low oil pressure indicator is not illuminated.
Engine Stop/Run Switch	Start the engine. Move the stop/run switch to the STOP position. Verify that the engine stops. Attempt to restart the engine to verify that the engine WILL NOT start.

GENERAL INSPECTIONS

ITEM	INSPECTION PROCEDURE
Engine Oil	Check the oil level. See page 44.
Fuel	Check the fuel level. See page 50.
Coolant Level	Check the coolant level in the recovery bottle. See page 72.
Fluid Leaks	Check the vehicle and the ground/floor for any fuel, oil, coolant or hydraulic fluid leaks.
Tires	Inspect condition, pressure and tread depth. See page 46.
Brake Operation	Inspect pedal and lever movement.
Brake Fluid Levels	Check front and rear brake fluid levels.
Brake Components	Inspect hoses and connections.
Throttle	Inspect hand grip and throttle movement.
Clutch	Check lever operation and freeplay. See page 49.
Front Suspension	Check for leaks, debris and damage.
Steering	Check for smooth operation by turning handlebars full left and full right.
Rear Suspension	Check mounting and inspect for leaks.
Rear Drive Belt	Check for wear or damage. See page 78 and page 79.
Sidestand	Verify smooth operation, inspect pivot bolt and spring.
Fasteners	Inspect for loose, damaged or missing fasteners.
Mirrors	Adjust for proper rear view.

PRE-RIDE INSPECTIONS

ENGINE OIL LEVEL

With the semi-dry sump lubrication system, the engine oil level on the dipstick will fluctuate, depending on the motorcycle's position and engine speed when the engine is turned off. To ensure a proper reading of the engine oil level, follow all inspection procedures closely.

WARNING! Operating with insufficient, deteriorated or contaminated engine oil will cause accelerated wear and may result in engine or transmission seizure, which could result in loss of control and serious injury or death. Check the oil level frequently.

Always check the oil after running a cold engine at idle for 30 seconds. The oil fill/dipstick is located on the right side of the motorcycle. Always use the recommended oil. See page 122.

1. Position the motorcycle on level ground in the fully upright and centered position.
2. Start the engine (from cold) and allow it to idle for 30 seconds. Stop the engine.

3. Remove the dipstick  and wipe it clean.

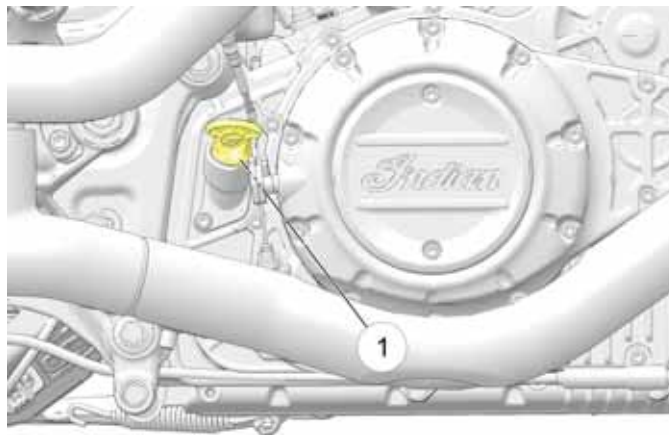

4. Thread the dipstick until fully seated.
5. Remove the dipstick and view the oil level.

NOTICE: Do not overfill. Overfilling can result in loss of engine performance and an oil-saturated air filter. Use a suction device to remove excess oil if overfilled.

6. Add the recommended oil as needed to bring the level to the FULL mark on the dipstick. Verify the level on the dipstick.
-

TIP: The approximate volume between the FULL ω and ADD \ominus marks on the dipstick is 16 oz. (.45 L).



7. Reinstall the dipstick securely.
-

PRE-RIDE INSPECTIONS

TIRES

WARNING! Operating the motorcycle with incorrect tires, incorrect tire pressure or excessively worn tires could cause loss of control or accident. Underinflation can cause a tire to overheat and result in a tire failure. Always use the correct size and type of tires specified by INDIAN MOTORCYCLE for your vehicle. Always maintain proper tire pressure as recommended in the rider's manual and on safety labels.

TIRE PRESSURE

Improper tire pressure can result in irregular tire wear, tire failure, reduced fuel economy and a poor riding experience. It can also affect handling and stopping ability.

Slow tire pressure loss over time is normal for a functional tire. Always inspect tire pressure and condition before each ride.

Check tire pressure before riding, when the tires are cold. This will provide the most accurate reading, as riding warms the tires and increases tire air pressure. Tires remain warm for at least 3 hours after a ride. Do not adjust tire pressure immediately after riding. As tires cool, the pressure will drop and result in underinflation. Always check and adjust tire pressure when tires are cold.

Using a good quality pocket-style gauge, adjust tire pressure to the recommended pressure. See page 94.

TIRE CONDITION

Inspect the tire sidewalls, road contact surface and tread base. If inspection reveals cuts, punctures, cracks or other wear or damage, replace the tire before riding. Always use the correct size and type of tires specified by INDIAN MOTORCYCLE for your vehicle.

TIRE TREAD DEPTH

Measure the tread depth near the center of the tread on both tires. See page 93. Replace any tire with a tread depth of less than 1/16 inch (1.6 mm).

FRONT BRAKE FLUID LEVEL

1. Straddle the motorcycle and bring it to the fully upright position. Position the handlebars so that the fluid reservoir is level.
2. View the fluid level through the sight glass Q . The fluid should be clear. Replace cloudy or contaminated fluid.
3. The fluid level should be above the minimum indicator mark W in the sight glass.
4. If the fluid level is low, inspect brake pads as outlined in page 90. If pads are not worn beyond the service limit, inspect the brake system for leaks. Check for signs of brake fluid leaks around hoses, fittings, reservoir, and brake calipers.
5. Add brake fluid if necessary. See page 89.

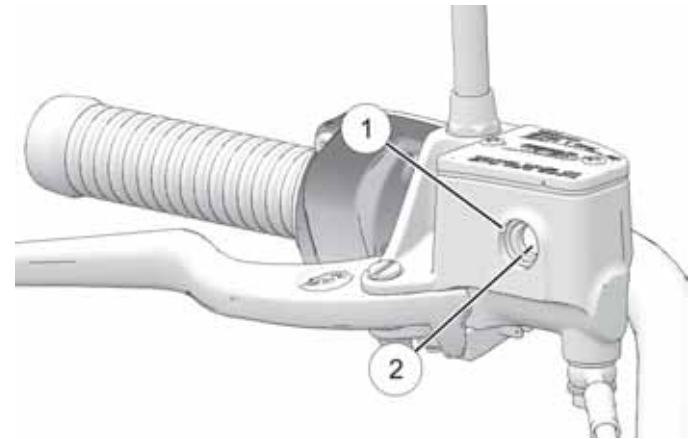

PRE-RIDE INSPECTIONS

FRONT BRAKE LEVER

1. Pull the front brake lever toward the handlebar and hold it. The lever should move freely and smoothly. The lever should feel firm and continue to feel firm until released.
2. Release the lever. It should return to its rest position quickly when released.
3. If the front brake lever fails to perform as stated, service the brake lever before riding.

REAR BRAKE PEDAL

1. Press downward on the rear brake pedal. It should move freely and smoothly. The pedal should feel firm and continue to feel firm until released.
2. Release the pedal. It should return to its rest position quickly when released.
3. If the rear brake pedal fails to perform as stated or travels too far before beginning to engage the brake, service the brakes before riding.

REAR BRAKE FLUID LEVEL

The rear brake fluid reservoir is located near the rear brake pedal. View the reservoir level from the right side of the vehicle.

1. Position the motorcycle on level ground in the fully upright position.
2. View the brake fluid through the reservoir .
3. The fluid should be clear. Replace cloudy or contaminated fluid.
4. The fluid level should be above the minimum indicator mark on the reservoir body. Add brake fluid as needed. See page 88.

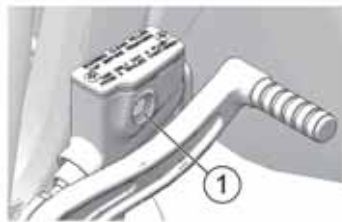

BRAKE LINES

Inspect all brake hoses and connections for dampness or stains from leaking or dried fluid. Tighten any leaking connections to the proper torque values and replace components as necessary. See the *INDIAN MOTORCYCLE Service Manual* or an authorized INDIAN MOTORCYCLE dealer or other qualified dealer.

WARNING! Brake fluid leaks or low brake fluid levels could cause brake system failure, which could result in serious injury or death. Do not operate the vehicle with low brake fluid levels or when leaks are evident (dampness or stains from dried fluid). See your authorized INDIAN MOTORCYCLE dealer or other qualified dealer.

MECHANICAL CLUTCH

1. Squeeze the clutch lever Q toward the handlebar and release it. It should move freely and smoothly, and it should return to the rest position quickly when released. If the lever fails to perform as stated, service the clutch lever before riding.



2. Freeplay (gap) is the amount of lever movement from the rest position to the point of cable resistance. Clutch lever freeplay should be 0.5-1.5 mm. Measure the gap between the clutch lever and the lever housing. See page 85. Adjust clutch lever freeplay if necessary.

TIP: The starter interlock switch is dependent on the clutch lever freeplay being set correctly to ensure activation of the clutch safety switch.

PRE-RIDE INSPECTIONS

THROTTLE

Rotate the throttle control grip. It should rotate smoothly from the rest position to the completely open position. It should return to the rest position quickly when released.

FRONT SUSPENSION

Inspect the front forks for oil leaks or damage, and verify smooth suspension operation. See page 82.

REAR SUSPENSION

Check the rear shock absorber mounting and inspect for leaks. See your dealer for service if you discover leaks or malfunction of any kind. See page 80 and page 81.

WARNING! Inadequate ground clearance could result in components contacting the ground, causing loss of control and serious injury or death. Always ensure ground clearance is at specification.

REAR DRIVE BELT

1. Check the drive belt teeth for stones or other debris.
2. Inspect drive belt condition. See page 78. If you discover cracks, broken teeth or frayed edges, replace the drive belt before riding. See the *INDIAN MOTORCYCLE Service Manual* or an authorized INDIAN MOTORCYCLE dealer or other qualified dealer.

FUEL LEVEL

1. Position the motorcycle on level ground in the fully upright position.
2. Slowly open the fuel cap.
3. View the fuel level in the tank.
4. Refuel as needed. See page 55 for fueling instructions. See page 122 for fuel specifications.

SIDESTAND

1. On level ground, straddle the motorcycle and bring it to the fully upright position.
2. Move the sidestand up to the stored position and down to the fully extended position several times. It should move smoothly and quietly. Make sure the return spring holds the sidestand tightly in place when the sidestand is in the stored position. Adjust or replace a loose spring.
3. Inspect the sidestand pivot bolt for looseness or wear. Tighten or replace a loose or worn bolt.

FASTENERS

1. Inspect the entire motorcycle chassis and engine for loose, damaged or missing fasteners.
2. Tighten loose fasteners to the proper torque. See the *INDIAN MOTORCYCLE Service Manual* or an authorized INDIAN MOTORCYCLE dealer or other qualified dealer.

TIP: Always replace stripped, damaged or broken fasteners before riding. Use genuine INDIAN MOTORCYCLE fasteners of equal size and strength.

OPERATION

The operation section of this manual describes how to ensure maximum performance and longevity through the proper care and operation of your motorcycle.

Important areas covered by the operation section include:

- Engine Break-In
- Fueling
- Starting the Engine
- Shifting Gears
- Accelerating
- Braking
- Stopping the Engine
- Parking

TIP: Even if you're an experienced motorcycle operator or passenger, read all of the safety information in this manual before operating the motorcycle.

ENGINE BREAK-IN

The engine break-in period for your motorcycle is the first 500 miles (800 km) of operation. During this break-in period, critical engine parts require special wear-in procedures so they seat and mate properly. Read, understand and follow all break-in procedures to ensure the long-term performance and durability of your engine.

NOTICE: Failure to properly follow the engine break-in procedures outlined in this manual can result in serious damage to the engine. Follow all break-in procedures carefully. Avoid full throttle operation and other conditions that may place an excessive load on the engine during the break-in period.

The more cautiously you treat your motorcycle during the break-in period, the more satisfied you will be with its performance later on. Overloading the engine at low RPM and/or running the engine prematurely at high RPM may result in damage to the engine components.

Observe the following precautions during the break-in period:

- Upon initial start-up, do not allow the engine to idle for long periods as overheating can occur.
- Avoid fast starts with wide open throttle. Drive slowly until the engine warms up.
- Avoid running the engine at extremely low RPM in higher gears (lugging the engine).
- Drive within the recommended operating speeds and gears. See page 54.

OPERATION

OPERATING SPEEDS AND GEARS

ODOMETER		BREAK-IN PROCEDURE
MILES	KM	
0-90	0-145	Do not operate for extended periods above 1/3 throttle or at any one throttle position. Vary engine speed frequently.
91-300	146-483	Do not operate for extended periods above 1/2 throttle or at any one throttle position. Vary engine speed frequently.
301-500	484-800	Do not operate for extended periods above 3/4 throttle.
At 500	At 800	Perform the break-in maintenance outlined in the maintenance section of this manual. Break-in maintenance should be performed by a dealership. Break-in maintenance must include inspection, adjustments, fastener tightening and an engine oil and filter change. Performing break-in maintenance at the required odometer reading helps ensure peak engine performance, minimal exhaust emissions and maximum service life of the engine.

FUELING

Always dismount the motorcycle and refuel on level ground with the sidestand down. Review the fuel warnings. See page 17. Use only the recommended fuel. See page 122.

WARNING! Overflows or spilled gasoline could contact a hot engine or exhaust system and cause a fire, which could result in serious injury or death. Do not allow gasoline to contact hot components.

WARNING! Always open the fuel cap slowly and fill the fuel tank slowly to prevent spillage. Do not overfill the fuel tank. Leave space in the tank to allow for the fuel to expand.

1. To open the fuel tank cap C_1 , insert the ignition key into the cap lock and turn it clockwise. Hold the key in this position while lifting the cap.

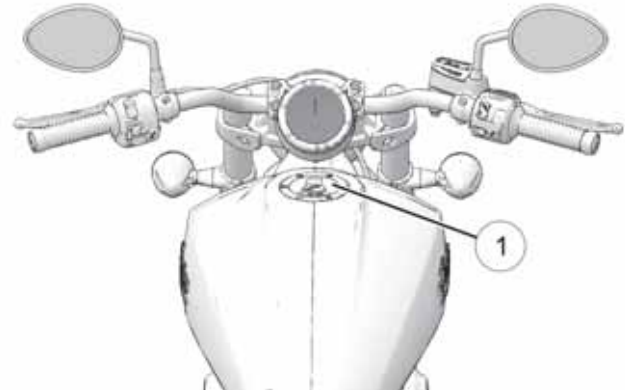

OPERATION

2. Insert the fuel nozzle into the fuel tank filler neck.
3. Hold the nozzle while filling. Do not rest the weight of the nozzle and hose on the filler neck. Do not leave the nozzle unattended.
4. Add fuel to the tank until it touches the bottom edge of the filler neck. The tank is full at this level.
5. Always close and lock the fuel cap before remounting the motorcycle. With the key rotated clockwise, close the fuel cap with your opposite hand and press it down firmly. Turn the key counter-clockwise to secure the lock.
6. If the motorcycle runs out of fuel, prime the system before attempting to restart the engine. See page 56.

NOTICE: Fuel can damage painted surfaces and plastic parts. If gasoline spills on the any part of the motorcycle, immediately rinse it off with water or wipe it dry with a clean cloth.

PRIMING THE FUEL SYSTEM

If the motorcycle runs out of fuel, prime the fuel system before attempting to restart the engine.

1. Fill the fuel tank.
2. Turn the ignition key to the ON position.
3. Move the engine stop/run switch to the RUN position.
4. Allow the fuel pump to run until it stops (about 2 seconds).
5. Move the engine stop/run switch to the STOP position.
6. Repeat steps 3–5 four to five times.
7. Turn the key to the OFF position.
8. Start the engine. See page 57.

STARTING THE ENGINE

The starter interlock system allows the engine to be started only when the transmission is in neutral, or when the transmission is in gear with the clutch disengaged (clutch lever pulled in).

1. Perform the Pre-Ride Inspections. See page 41. Properly secure any cargo.
2. Straddle the motorcycle and bring it to the fully upright position. Retract the sidestand.
3. Turn the ignition key to the ON position.
4. Move the engine stop/run switch to the RUN position.
5. Shift the transmission to neutral.
6. Apply the front brakes. Disengage the clutch (pull the clutch lever fully toward the handlebar).
7. Press and release the starter switch to start the engine. The starter motor will crank until the engine starts, but no more than 3 seconds. If the engine does not start, wait five seconds, then try again.
8. *If starting a COOL engine*, DO NOT open the throttle while starting. Idle speed is computer controlled and will adjust automatically. Allow the engine to warm up for 30 seconds minimum at low RPM after starting. Do not run the engine above 2500 RPM. *If starting a WARM engine*, DO NOT open the throttle while starting.

9. If either the check engine indicator or the low oil pressure indicator remains on after the engine starts, stop the engine *immediately*. Refer to the low oil pressure indicator information on page 32.

NOTICE: Operating an engine with a misfire or non-firing cylinder can overheat the catalytic converter, which could result in catalytic converter damage and loss of emission control. DO NOT OPERATE the motorcycle if a misfire or non-firing cylinder exists.

10. Leave the throttle closed and allow the engine to idle. Idle speed will gradually slow to normal as the engine warms to operating temperature.

TIP: Do not rev the engine or put the transmission in gear immediately after starting the engine. Allow the engine to idle for about 30 seconds after a warm start or at least one minute after a cold start (longer in cold weather). This will allow oil to reach all areas before the engine is put under load.

NOTICE: Do not run the engine at high RPM with the clutch disengaged or the transmission in neutral. Maximum safe engine speed is 8300 RPM. Never exceed the maximum safe RPM as this could result in serious engine damage.

OPERATION

MISFIRE DETECTION

If a misfire is detected, the check engine indicator lamp will begin to flash and fuel will be cut to the affected cylinder(s). The check engine indicator lamp will continue to flash until the ignition switch has been moved to the off position. Restarting the engine will clear the flashing indicator and restore fuel to both cylinders. If another misfire occurs, the check engine indicator lamp will resume flashing and fuel will once again be cut to the affected cylinder(s). After the 3rd misfire, P0314 misfire fault is determined & set, the check engine light will remain on and fuel will be cut to the affected cylinder(s). If this occurs, your INDIAN dealer can assist.

SHIFTING GEARS

WARNING! Forced shifting (with clutch engaged) could cause damage to the engine, transmission and drive train. Such damage could cause loss of control, which could result in serious injury or death. Always pull the clutch lever fully toward the handlebars to disengage the clutch before shifting gears.

Your motorcycle may be equipped with either a five-speed or a six-speed transmission. Neutral is located between first and second gear.

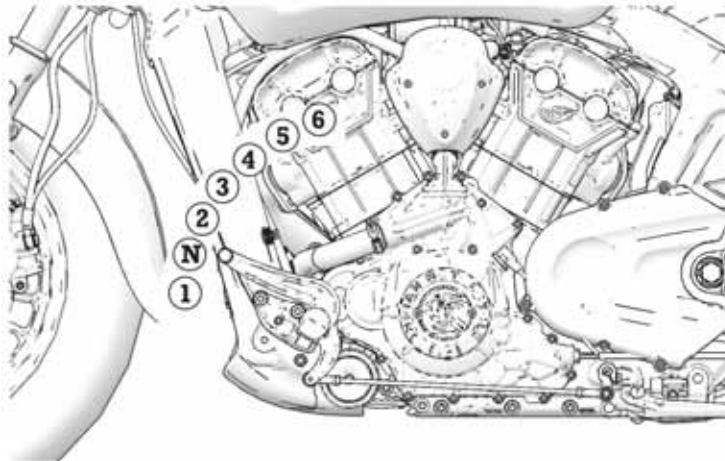

Press downward on the toe lever to shift to a lower gear. Lift upward on the toe lever to shift to a higher gear. Release the clutch lever after each gear shift.

Shifting to neutral is easiest if the motorcycle is rolling slowly. To shift from first gear to neutral, gently lift the toe lever a half stroke.

TIP: The transmission is in neutral if you can move the motorcycle forward or rearward freely without disengaging the clutch. If the ignition switch is in the ON position, the neutral indicator illuminates when the transmission is in neutral.

SHIFTING GEARS WHILE STATIONARY

To locate neutral when the motorcycle is stationary, use one of the following techniques to load and unload the transmission shift dogs, which allows them to disengage:

1. With the clutch disengaged (lever pulled inward), shift into neutral while rocking the motorcycle forward and rearward.
2. With the transmission in first gear, gently release the clutch until it just begins to engage. Apply upward pressure on the toe lever and quickly pull the clutch inward.

NOTE: There is a Neutral indicator light on the instrument cluster.

To shift gears when the motorcycle is stationary (engine may be running or stopped), disengage the clutch and apply slight pressure on the shift lever while rocking the motorcycle forward and rearward.

OPERATION

SHIFTING GEARS WHILE DRIVING

1. Start the engine. See page 57.
2. With the engine at idle speed, apply the front brakes.
3. Disengage the clutch (pull the clutch lever fully toward the handlebar).
4. Push the toe lever downward until you feel it stop in first gear.
5. Release the brake lever.
6. Simultaneously release the clutch lever while opening the throttle (rolling the throttle control grip rearward) in one smooth motion. As the clutch begins to engage, the motorcycle will move forward.
7. To shift to a higher gear, accelerate smoothly to the recommended shift point. See *Recommended Shift Points* chart. With a quick motion, simultaneously close the throttle completely and disengage the clutch. Raise the toe shift lever until you feel it stop at the next gear. Simultaneously release the clutch lever and open the throttle in one smooth motion.

TIP: Within the recommended speed ranges (see Recommended Shift Points chart), you can downshift to slow the motorcycle or to increase power. You may want to downshift when climbing a hill or passing. Downshifting also helps to decrease speed when combined with closing the throttle.

8. To shift to a lower gear (downshift), simultaneously pull the clutch lever toward the handlebar and close the throttle. Move the toe shift lever downward until you feel it stop at the next gear. Simultaneously release the clutch lever while opening the throttle.

WARNING! Downshifting improperly could cause transmission damage, loss of traction and loss of control, which could result in serious injury or death.

- Reduce speed before downshifting. Always downshift within the recommended shift points.
 - Use extreme caution when downshifting on wet, slippery or other low traction surfaces. Release the clutch lever very gradually in these conditions.
 - Avoid downshifting in a curve. Downshift before entering the curve.
-

RECOMMENDED SHIFT POINTS

UPSHIFTING (ACCELERATING)			DOWNSHIFTING (DECELERATING)	
GEAR CHANGE	RECOMMENDED SPEED		GEAR CHANGE	RECOMMENDED SPEED
1 to 2	17 MPH (27 km/h)		6 to 5 (if equipped)	40 MPH (65 km/h)
2 to 3	24 MPH (38 km/h)		5 to 4	35 MPH (56 km/h)
3 to 4	35 MPH (57 km/h)		4 to 3	29 MPH (47 km/h)
4 to 5	41 MPH (66 km/h)		3 to 2	20 MPH (33 km/h)
5 to 6 (if equipped)	50 MPH (81 km/h)		2 to 1	10 MPH (16 km/h)

OPERATION

BRAKING

Always allow sufficient stopping distance so that brakes can be applied gradually.

TIP: Applying slightly more front brake than rear brake generally provides the best braking performance.

1. To slow the motorcycle with the brakes, close the throttle and apply the front and rear brakes evenly and gradually.

TIP: When the anti-lock brakes engage during a braking event, the rider will feel pulsing at the brake lever. Continue to apply steady pressure to the brakes for the best stopping performance.

2. As the motorcycle slows, disengage the clutch, or downshift each time vehicle speed reaches a downshift point.

WARNING! Braking improperly could result in loss of control, which could result in serious injury or death. Avoid braking abruptly. Always apply the brakes gradually, especially on wet, slippery or other low traction surfaces. Avoid braking in a curve or turn. Bring the motorcycle to the upright position before applying the brakes.

ACCELERATING

Accelerate by opening the throttle (rolling the throttle control grip rearward). For even acceleration, open the throttle with a smooth, continuous motion. When you reach the recommended speed for upshifting, shift up one gear.

WARNING! Accelerating abruptly could cause your body to shift rearward suddenly, which could result in loss of control. Accelerating abruptly could also cause loss of control on low traction surfaces. Loss of control could result in serious injury or death. Always accelerate gradually, especially on wet, slippery or other low traction surfaces.

STOPPING THE ENGINE

Before stopping the engine, bring the motorcycle to a complete stop. Shift to neutral or disengage the clutch.

WARNING! Stopping the engine with the transmission in gear while the motorcycle is moving could cause loss of rear wheel traction or engine and transmission damage, which could cause loss of control and serious injury or death. Always stop the engine after the motorcycle is fully stopped and the transmission is in neutral. If the engine stops unexpectedly while the motorcycle is moving, pull the clutch and guide the motorcycle to a safe location off the road and away from traffic. Turn the ignition switch off.

1. When fully stopped, shift into neutral.
2. Move the engine stop/run switch to the STOP position.
3. Turn the ignition switch off. Remove the ignition key.

PARKING

Choose a firm level surface to park the motorcycle.

1. When fully stopped, shift into neutral.
2. Stop the engine.
3. Fully extend the sidestand.
4. Turn the handlebars to the left and lean the motorcycle to the left until the sidestand firmly supports the motorcycle.
5. Remove the ignition key.

PARKING ON A SLOPE

If parking on a slope is unavoidable, park with the front wheel uphill from the rear wheel. Place the transmission in first gear and position the motorcycle so that it is stable when it rests on the sidestand.

NOTICE: Always park with the front wheel uphill from the rear wheel when parking on a slope. If the front wheel is downhill from the rear wheel, the sidestand could retract and cause a tipover.

PARKING ON A SOFT SURFACE

If parking on a soft surface is unavoidable, place a sidestand footrest under the foot of the sidestand to provide a firm surface. The sidestand footrest must be strong enough and large enough to support the motorcycle's weight without sinking into the parking surface.

Asphalt becomes soft in hot weather. A sidestand can sink into soft asphalt and the motorcycle may fall. When parking on asphalt in hot weather, use a sidestand footrest.

CAUTION! Hot engine and exhaust components can cause burns to skin and can ignite a fire if exposed to flammable materials. Always park the motorcycle clear of flammable materials and where people are not likely to contact hot components.

MAINTENANCE

Proper maintenance assures the highest level of safety, durability and dependability for your motorcycle. Break-in maintenance is required to ensure warranty coverage and proper emissions system operation.

- Perform the *break-in maintenance procedures* when the motorcycle's odometer registers 500 miles (800 km). Please see your authorized dealer for this service.
- Perform the recommended *periodic maintenance* at the intervals specified in the Periodic Maintenance Table beginning on page 67.

SAFETY DURING SERVICE PROCEDURES

WARNING! Failure to follow all recommended precautions and procedures could result in severe injury or death. Always heed all safety precautions and follow all operation, inspection and maintenance procedures outlined in this manual.

- Improperly installed or adjusted components can make the motorcycle unstable or hard to handle. Improperly installed electrical components can cause engine or electrical system failure. In either event, damage or serious injury could result. If you do not have the time, tools and expertise necessary to complete a procedure properly, please see your dealer for service.
 - Review the safety-related maintenance information on page 18.
 - Before beginning any maintenance procedure, read the instructions for the entire procedure.
 - Always position the motorcycle on a firm level surface before performing service. Make sure the motorcycle will not tip or fall while elevated or while on the sidestand. See page 101.
 - Hot engine and exhaust components can cause burns to skin and can ignite a fire if exposed to flammable materials. Always park the motorcycle clear of flammable materials and where people are not likely to contact hot components.
 - Wear eye and face protection when using pressurized air.
 - Never start the engine or let it run in an enclosed area. Engine exhaust fumes are poisonous and can cause loss of consciousness or death in a short time.
 - During some procedures you may use potentially hazardous products such as oil or brake fluid. Always follow the instructions and warnings on the product packaging.
-

MAINTENANCE

ROAD TESTS

Before returning the motorcycle to regular use after performing service, road test it in a safe environment. Pay special attention to the proper fit and operation of all serviced components. Make any corrections or additional adjustments necessary to ensure safe vehicle performance.

BREAK-IN MAINTENANCE

Perform the break-in maintenance procedures when the motorcycle's odometer registers 500 miles (800 km). Please see your authorized dealer for this service.

Performing the break-in maintenance will help ensure optimum engine performance for the entire service life of the engine. Your dealer will change engine oil, inspect all fluids and serviceable components, ensure that all fasteners are tightened and make other adjustments as needed.

MAJOR MAINTENANCE

Major repairs typically require technical skills and specially designed tools. Emission system service requires special tools and training and should be performed by your dealer. See the *INDIAN MOTORCYCLE Service Manual* or an authorized INDIAN MOTORCYCLE dealer or other qualified dealer.

PERIODIC MAINTENANCE

Inspect, clean, lubricate, adjust and replace parts as necessary. When inspection reveals the need for replacement parts, use genuine INDIAN MOTORCYCLE parts available from your dealer. Record service and maintenance information in the Maintenance Log beginning on page 135.

NOTICE: Use of non-recommended lubricants and components can result in damage to the motorcycle. Damage resulting from the use of non-recommended products is not covered by warranty.

Perform maintenance at the intervals specified in the Periodic Maintenance Table on page 67. *Vehicles subjected to severe use must be inspected and serviced more frequently.*

SEVERE USE DEFINITION

- high speed operation for extended periods
- low speed operation for extended periods
- operation in dusty or otherwise adverse conditions
- operation in cold weather (temperatures below freezing)

PERIODIC MAINTENANCE TABLE

ENGINE

Component	Odometer Reading in Miles (Kilometers)																
	500 (800)	2,500 (4,000) & every 5,000 (8,000) thereafter	5,000 (8,000)	10,000 (16,000)	15,000 (24,000)	20,000 (32,000)	25,000 (40,000)	30,000 (48,000)	35,000 (56,000)	40,000 (64,000)	45,000 (72,000)	50,000 (80,000)					
Engine Oil & Filter*	R	-	-	R	-	R	-	R	-	R	-	R	-	R	-	R	
Crankcase Vent	I	I	I	I	I	I	I	I	I	I	I	I	I	I	I	I	
Oil Lines/Oil System Inspection	I	I	I	I	I	I	I	I	I	I	I	I	I	I	I	I	
Air Filter	I	I	I	R	I	R	I	R	I	R	I	R	I	R	I	R	
Cooling System/Radiator	I	I	I	I	I	I	I	I	I	I	I	I	I	I	I	R	
Exhaust System	I	I	I	I	I	I	I	I	I	I	I	I	I	I	I	I	
Valve Lash Clearance	-	-	-	-	-	I	-	-	-	-	I	-	-	-	-	-	
Spark Plugs	-	-	-	-	I	-	-	-	-	R	-	-	-	-	I	-	
<p>Maintenance Key: I = Inspect, clean, adjust, correct or replace if necessary; P = Perform; R = Replace/Rebuild L = Lubricate w/ proper lubricant; * = Replace at specified interval or annually; ** = Replace as specified or every 2 years</p>																	

MAINTENANCE

CHASIS

Component See table key below	Odometer Reading in Miles (Kilometers)															
	500 (800)	2,500 (4,000) & every 5,000 (8,000) thereafter	5,000 (8,000)	10,000 (16,000)	15,000 (24,000)	20,000 (32,000)	25,000 (40,000)	30,000 (48,000)	35,000 (56,000)	40,000 (64,000)	45,000 (72,000)	50,000 (80,000)				
Battery/Connections	I	I	I	I	I	I	I	I	I	I	I	I	I	I	I	I
Brake Fluid**	I	I	I	R	I	R	I	R	I	R	I	R	I	R	I	R
Brake Lines/Brake Pads	I	I	I	I	I	I	I	I	I	I	I	I	I	I	I	I
Clutch Cable	I	-	I	L	I	L	I	L	I	L	I	L	I	L	I	L
Clutch Lever (Mechanical)	L	-	I	L	I	L	I	L	I	L	I	L	I	L	I	L
Diagnostic Codes	I	I	I	I	I	I	I	I	I	I	I	I	I	I	I	I
Drive Belt (Rear)	I	I	I	I	I	I	I	R	I	I	I	I	I	I	I	I
Drive Belt Tension Adjustment	I	I	I	I	I	I	I	I	I	I	I	I	I	I	I	I
Electrical Equipment/ Switches	I	I	I	I	I	I	I	I	I	I	I	I	I	I	I	I
Evaporative Emission Control System (if equipped)	I	I	I	I	I	I	I	I	I	I	I	I	I	I	I	I
Fasteners	I	I	I	I	I	I	I	I	I	I	I	I	I	I	I	I
Front Brake Lever	L	-	I	L	I	L	I	L	I	L	I	L	I	L	I	L
ABS Components	I	I	I	I	I	I	I	I	I	I	I	I	I	I	I	I
Front Fork Oil**	I		I	I	R	I	I	R	I	I	R	I	I	R	I	I
Front Fork/Axle	I	I	I	I	I	I	I	I	I	I	I	I	I	I	I	I

MAINTENANCE

Fuel System/Lines/Fittings	I	I	I		I		I		I		I		I		I		I		I
Fuel Filter	-	-	-		-		-		R		-		-		-		-		R
Gear Shift Lever	I	I	I		L		I		L		I		L		I		L		L
Headlamp	I	I	-		I		-		I		-		I		-		I		I
Rear Suspension Rocker	I	I	I		I		L		I		I		L		I		I		L
Rear Shock Unit	I	I	I		I		I		I		I		I		I		I		R
Rear Wheel Alignment	I	I	I		I		I		I		I		I		I		I		I
Rear Brake Pedal	I	I	I		L		I		L		I		L		I		L		L
Road Test	P	P	P		P		P		P		P		P		P		P		P
Sidestand	L	I	L		I		I		I		I		I		I		I		I
Steering Bearings	I	I	I		I		I		I		I		I		I		I		I
Suspension Linkage, Rear	I	I	I		I		I		I		I		I		I		I		I
Swingarm/Rear Axle	I	I	I		I		I		I		I		I		I		I		I
Tires/Wheels/Spokes	I	I	I		I		I		I		I		I		I		I		I
<p style="text-align: center;">Maintenance Key: I = Inspect, clean, adjust, correct or replace if necessary; P = Perform; R = Replace/Rebuild L = Lubricate w/ proper lubricant; * = Replace at specified interval or annually; ** = Replace as specified or every 2 years</p>																			

MAINTENANCE

ENGINE OIL/FILTER CHANGE

Follow all instructions carefully. Do not overfill.

Change the engine oil at the intervals specified in the periodic maintenance table beginning on page 67. Change the oil more frequently if the motorcycle is subjected to severe use, especially operation in cold weather. See page 66. Always use the recommended oil. See page 122.

NOTICE: Failure to perform frequent oil changes during cold weather operation can result in condensation forming. Freezing condensation can result in plugged oil lines and serious engine damage.

NOTICE: After an oil change, the low oil pressure indicator may illuminate when the engine is started. If this occurs, do not increase RPM above idle speed until the indicator turns off. Operating above idle speed could result in damage to the engine.

1. Change the oil and filter Q when the engine is warm. If the engine is cold, start the engine and allow it to run at idle for at least five (5) minutes.
2. Park the motorcycle with the sidestand down on a firm, level surface. For proper oil drain, use a service lift to ensure the motorcycle is vertically centered.

3. Clean the area around the two drain plugs W . Place a drain pan under both drain plugs.

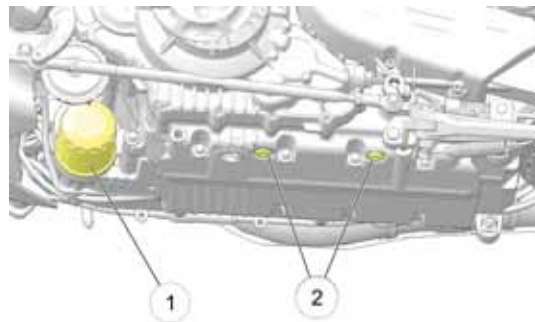

INDIAN SCOUT shown

CAUTION! Hot oil can cause burns to skin. Do not allow hot oil to contact skin.

4. Remove the drain plugs. Allow the oil to drain completely.
5. Install new sealing washers on the drain plugs. The sealing surfaces on drain plugs and engine should be clean and free of burrs, nicks or scratches.

6. Reinstall the drain plugs.

TORQUE: 15 ft-lbs (20 Nm)

7. Place a drain pan or shop towels under the oil filter. Using an oil filter wrench, turn the filter counter-clockwise to remove it. If necessary, remove the horn bracket to improve access.
8. Using a clean dry cloth, clean the filter sealing surface on the engine.
9. Lubricate the o-ring on the new filter with a film of fresh engine oil. Check to make sure the o-ring is in good condition.
10. Install the new filter and rotate it clockwise by hand until the filter gasket contacts the sealing surface, then turn it an additional 3/4 to one full turn.
11. Reinstall the horn bracket if it was removed.
12. Remove the dipstick. Using a funnel, add 3-4 qts. (2.8-3.8 L) of the recommended oil. Reinstall the dipstick securely.
13. With the motorcycle in an upright, centered position, start the engine and allow it to idle for 30 seconds. Stop the engine.

14. Add the recommended oil as needed to bring the level to the FULL mark on the dipstick. Verify the level on the dipstick.

TIP: The approximate volume between the ADD and FULL marks on the dipstick is 16 oz. (.45 L).

15. Reinstall the dipstick securely

NOTICE: Do not overfill. Overfilling can result in loss of engine performance and an oil-saturated air filter. Use a suction device to remove excess oil if overfilled.

16. Dispose of used filter and oil properly.

NOTICE: After an oil change, the low oil pressure indicator may illuminate when the engine is started. If this occurs, do not increase RPM above idle speed until the indicator turns off. Operating above idle speed could result in damage to the engine.

MAINTENANCE

COOLING SYSTEM

The engine coolant level is controlled by the recovery system. Recovery system components are the recovery bottle, the radiator filler neck, the radiator pressure cap and the connecting hose.

As coolant operating temperature increases, the expanding (heated) excess coolant is forced out of the engine, past the pressure cap, and into the recovery bottle. As engine coolant temperature decreases the contracting (cooled) coolant is drawn back up from the bottle, past the pressure cap, and into the radiator.

Some coolant level drop on new vehicles is normal as the system is purging itself of trapped air. Check the coolant level and maintain as recommended by adding coolant to the recovery bottle.

INDIAN recommends the use of Antifreeze 50/50 Premix. This antifreeze is already premixed and ready to use. Do not dilute with water.

To ensure that the coolant maintains its ability to protect the engine, we recommend that the system be completely drained every five (5) years or 50,000 miles, whichever comes first. Please see your dealer for this service.

COOLANT LEVEL INSPECTION

TIP: A flashlight is required for viewing the coolant level.

1. Allow the engine to cool before checking coolant level.
2. Position the motorcycle on level ground in the fully upright position.

3. Place a flashlight \odot flush against an accessible area of the recovery bottle to illuminate the interior. View the coolant level through the window in the heat shield ω .

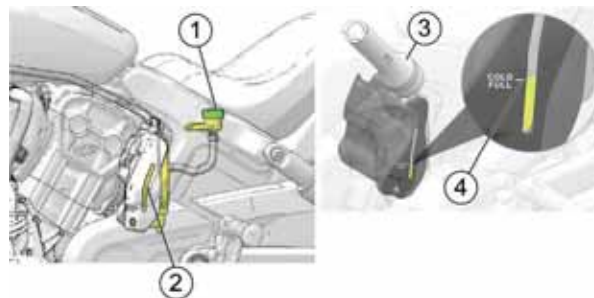

4. Maintain the coolant level at the COLD FULL Γ mark on the recovery bottle (when the fluid is cool).
5. If the level is low, remove the seat to access the coolant fill cap \odot .

TIP: The recovery bottle is vented to prevent overfilling. Coolant will vent onto the ground if overfilled.

6. Remove the fill cap and add coolant. Do not overfill.
7. Reinstall the cap.

AIR FILTER

Inspect and replace the air filter at the intervals specified in the periodic maintenance table beginning on page 67. Inspect more often if riding in unusually wet or dusty conditions.

1. Remove the seat. See page 95.
2. Remove the fuel tank. See page 74.

NOTICE: Use care to prevent debris from entering the air box when the filter is removed.

3. Loosen the six (6) captive air filter screws \square and remove the air filter ∇ .

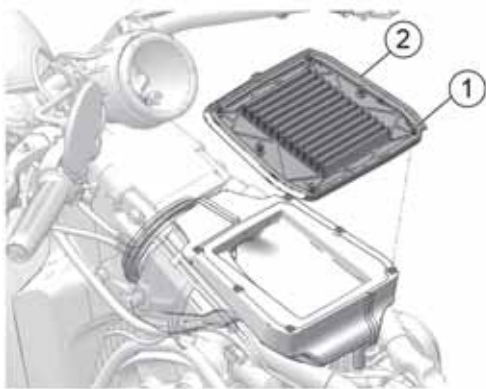

4. Inspect the air filter. Do not attempt to clean the air filter. Replace a soiled or damaged filter with a new filter.
5. Reinstall the air filter or install a new air filter.

6. Torque screws to specification.

TORQUE: 24 in-lbs (2.7 Nm)

7. Reinstall the fuel tank. See page 76.
8. Reinstall the seat. See page 95.

FUEL FILTER

The fuel filter is attached to the electric fuel pump located inside the fuel tank. See your authorized INDIAN MOTORCYCLE dealer or other qualified dealer for replacement.

MAINTENANCE

FUEL TANK REMOVAL

Please read the entire removal and reinstallation procedure before beginning. Do not attempt to remove and install the fuel tank if you're not comfortable with this procedure. Please see your dealer.

A special fuel tank fitting plug tool is required for this procedure. Please see your dealer to obtain this tool.



TOOL: PV-50567

Before beginning, be prepared to place the fuel tank in a secure location to avoid scratching the finish and to catch any fuel that may leak or drip from disconnected hoses or fittings.

1. Remove the seat. See page 95.
2. Lift the rear of the fuel tank filler pad \mathcal{W} to access the fuel tank bolts.

3. Remove the four (4) rear fuel tank bolts \ominus . Set hardware aside for reassembly.



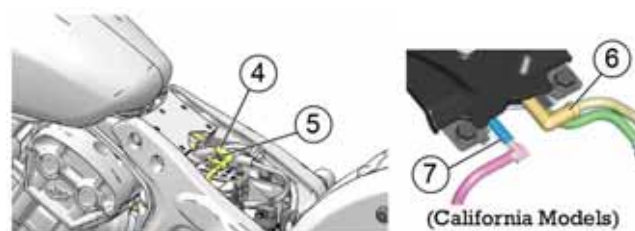

4. Locate the rubber elbow and the straight rubber coupler exiting the rear of the tank mounting bracket.
5. Gently pull the elbow free of the tube to disconnect the fuel tank vent line Γ (California models γ).

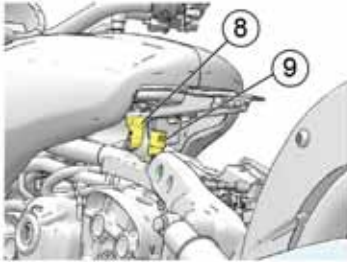

6. Gently pull the straight rubber coupler free of the tube to disconnect the fuel cap recess drain line \dagger (California models \cup).

7. Place the handlebars in the straight ahead position. Cover the front of the fuel tank with a protective cloth to prevent contact with the instrument cluster, which could cause damage.
8. Lift and support the rear of the tank approximately two inches (5 cm).
9. Disconnect the fuel pump electrical connector  by depressing the release tab on the connector body.



10. Wrap a shop towel around the fuel fitting.
11. Disconnect the fuel supply line connector  from the fuel pump by squeezing the release tabs on both sides of the fitting.

12. Install the fuel tank fitting plug tool  onto the fuel pump fitting to protect the fitting and prevent fuel from seeping out of the tank.

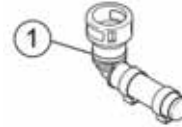

13. Lift the rear of the fuel tank and *carefully* slide it rearward to release it from the front isolators.

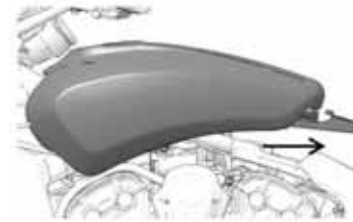

14. Lift the tank up and away from the frame. Reinstall the front isolators if they become dislodged.
15. Place the fuel tank on a flat surface in a secure location.

MAINTENANCE

FUEL TANK INSTALLATION

1. Place the handlebars in the straight ahead position. Cover the front of the fuel tank with a protective cloth to prevent damage.
2. Make sure the front isolators are installed to the frame. Apply alcohol, soapy water or rubber lubricant to the isolators and to the sides of the air box seal to ease tank installation.
3. Using care to avoid damage to the fuel tank fitting and special tool, lower the fuel tank onto the frame of the motorcycle. Slide the tank forward to make sure it's fully seated on the isolators.

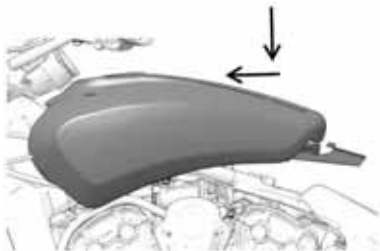

4. Pivot the rear of the tank upward to access the tank bottom. Support the rear of the tank in this position.

5. Remove the plug tool from the fuel pump fitting.
6. Reconnect the fuel supply line connector Q to the fuel pump. Make sure you hear a click to indicate proper engagement. Test the connection by pulling the fuel line lightly.

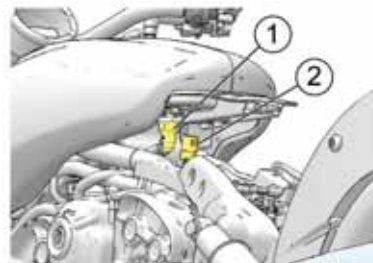

7. Connect the fuel pump harness electrical connector W. Make sure you hear a click to indicate proper engagement.
8. Verify that the fuel line is correctly routed and secured.

9. Slide the tank forward to make sure it's fully seated on the isolators.
10. Connect the fuel vent tank line Γ (California models \dagger).

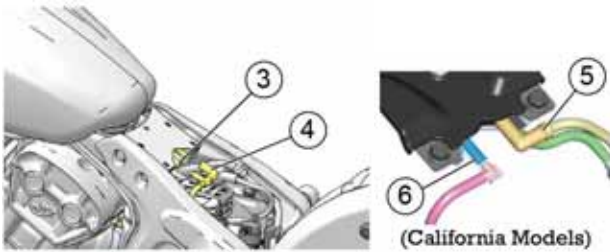

11. Connect the fuel cap recess line ϵ (California models γ).
12. Reinstall the fuel tank filler pad \cup .

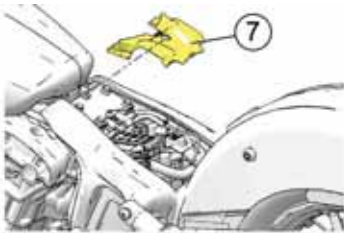

13. Reinstall the four (4) rear fuel tank bolts j .

TORQUE: 18 ft-lbs (24.4 Nm)

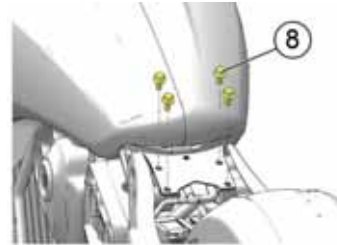

14. Prime the fuel pump. See page 56.
15. Check for leaks.
16. Reinstall the seat. See page 95.

MAINTENANCE

REAR DRIVE BELT CLEANING

Cleaning the drive belt will maximize belt and sprocket life and minimize drive line noise. Clean the belt at every tire change. Clean the belt more often if riding in dirty, dusty or high debris environments.

1. Mix a few drops of mild dish soap with a cup of warm water.
2. Use a soft nylon brush to clean the belt and sprocket teeth with the soapy water. Clean well in corner areas where road debris and belt dust can collect.
3. Rinse the belt with clear water, then dry thoroughly.



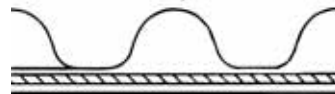

REAR DRIVE BELT CONDITION

Inspect the rear drive belt at the intervals specified in the Periodic Maintenance Table on page 67. Replace the drive belt if it is cracked or has broken teeth or frayed edges. No matter its condition, the drive belt should be replaced at periodic intervals. See the *INDIAN MOTORCYCLE Service Manual* or an authorized INDIAN MOTORCYCLE dealer or other qualified dealer.

Replace the drive belt and both sprockets as a set if the drive belt has over 5,000 miles (8,000 km) of service at the time of damage or failure.

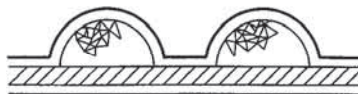
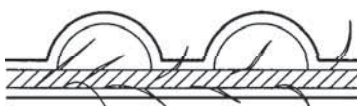
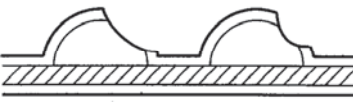

REAR DRIVE BELT WEAR ANALYSIS

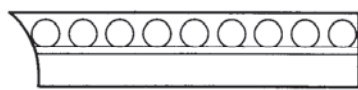
			
<p>Internal tooth cracks (hairline): OK to run, but monitor condition</p>	<p>External tooth cracks: Replace belt</p>	<p>Missing teeth: Replace belt</p>	<p>Chipping (not serious): OK to run, but monitor condition</p>
			
<p>Fuzzy edge cord: OK to run, but monitor condition</p>	<p>Hook wear: Replace belt</p>	<p>Stone damage: Replace belt if damage is on edge</p>	<p>Bevel wear (outboard edge only): OK to run, but monitor condition</p>

MAINTENANCE

REAR SHOCK PRELOAD (RIDE HEIGHT) INSPECTION

Periodically measure rear shock preload. Have an assistant help with this procedure.

For the most comfortable ride and proper ground clearance, adjust preload if ride height is out of specification.

1. Verify that tire pressure is at specification. See page 46.
2. Load the motorcycle with all intended cargo. Wearing your riding gear, bring the motorcycle to the upright position and sit on the operator's seat. If you plan to carry a passenger, have the passenger (with riding gear) sit on the passenger seat.

WARNING! Do not carry a passenger unless the motorcycle is equipped with passenger seat and passenger footrests.

3. Measure shock preload from upper mount bolt center to lower mount bolt center (eye-to-eye) \square . Perform this measurement on both shocks.
4. Ride height should be 282 mm on both shocks. If the measurement differs, adjust the preload. See page 81.

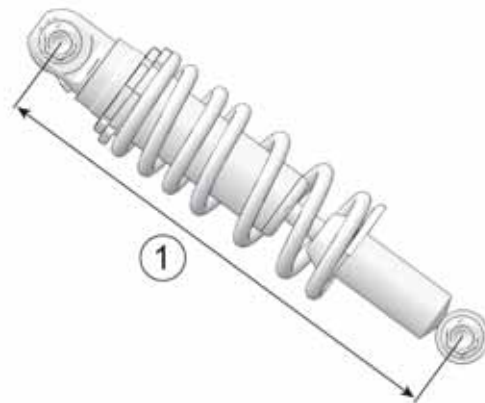

REAR SHOCK PRELOAD (RIDE HEIGHT) ADJUSTMENT

Special tools are required to perform this procedure. See the INDIAN Service Manual or your authorized INDIAN dealer or other qualified dealer.

WARNING! Uneven adjustment may cause poor handling of the motorcycle, which could result in an accident. Always adjust both the left and right shock preload equally, or have your dealer perform the adjustments.

1. Verify that tire pressure is at specification. See page 46.
2. Rest the motorcycle on the sidestand.

3. Loosen the lock nut Q by turning it counter-clockwise (as viewed from the top of shock) with the spanner wrench. The upper spanner nut on the shock is the lock nut. The lower spanner nut is the adjuster nut W .

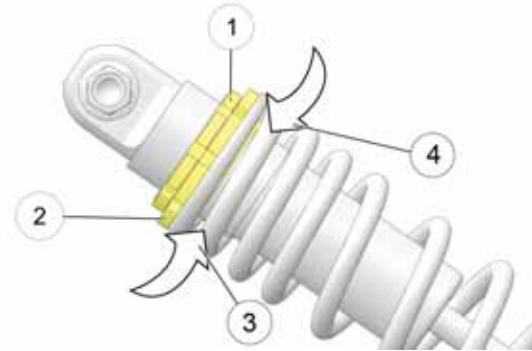

4. Spray a light lubricant on the adjuster nut where it contacts the spring. DO NOT allow spray to contact the drive belt.
5. Adjust shock preload by rotating the adjuster nut clockwise (as viewed from the top of shock) to INCREASE preload \ominus (firm) or counter-clockwise to DECREASE preload Γ (softer).
6. Recheck the preload measurement after adjusting.
7. Tighten the lock nut securely against the adjuster nut.

MAINTENANCE

SWING ARM/REAR AXLE INSPECTION

1. Sit in the operator's seat and slowly bounce the rear suspension a few times. Make sure the suspension moves freely without binding. Listen for abnormal noises.
2. Elevate and support the motorcycle with the rear tire slightly off the floor. See page 101

CAUTION! Make sure the motorcycle is stable when elevated. Injury may occur if the motorcycle tips or falls.

3. Grasp the rear wheel and attempt to move the wheel side-to-side. If there is movement at the front of the swingarm or in the axle area, see your dealer for service.
4. With the transmission in neutral, slowly rotate the rear wheel. If the wheel does not rotate smoothly, see your dealer for service.

FRONT FORK/SUSPENSION INSPECTION

1. Place the motorcycle on the sidestand and inspect the front forks. If fork oil is present on the outer tube C , *do not ride the motorcycle*. See your dealer for service before operating. If fork oil is present around the fork seals W or inner tubes e , replace the fork seals.

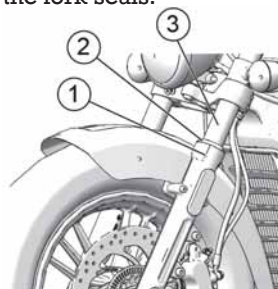

2. Clean the fork tubes to remove bugs, tar or buildup which may cause seal wear or leakage. Inspect the outer surfaces of the inner fork tubes for scratches or damage from foreign objects.
3. Straddle the motorcycle and bring it to the fully upright position. Apply the front brake and push downward (hard) on the handlebars several times. The front suspension should operate smoothly and quietly.
4. Fork oil condition and level affects front suspension performance and internal component wear. Replace fork oil at the recommended intervals. Special tools are required to perform this procedure. See the *INDIAN MOTORCYCLE Service Manual* or an authorized INDIAN MOTORCYCLE dealer or other qualified dealer.

STEERING HEAD INSPECTION

1. Elevate and support the motorcycle with the front tire slightly off the floor. See page 101.

CAUTION! Make sure the motorcycle is stable when elevated. Injury may occur if the motorcycle tips or falls.

2. Turn the handlebars from stop to stop. The action should be smooth but not loose. Make sure wires, hoses and control cables do not interfere with smooth steering.
3. Position the front wheel straight ahead. Grasp the front forks near the front axle and attempt to move the wheel front-to-back. If there is front-to-back movement at the steering head, see your dealer for service.
4. If steering binds, feels rough or uneven, or if movement is detected at the steering stem, see your dealer for service.
5. Rotate the front wheel and inspect for smooth rotation of front wheel bearings. If roughness or unusual sounds are present, see your dealer for service.
6. Turn handle bars full right or left and hold against the fork stop. Attempt to move front wheel side-to-side. If movement is observed, see your dealer for service.

CRANKCASE BREATHER HOSES

Inspect the crankcase breather (vent) hoses C each time the fuel tank is removed to perform air filter service or other maintenance. Inspect both breather hoses along their length and at both ends. Make sure hoses are not restricted, kinked, cracked or otherwise damaged. Replace any worn or damaged hoses.

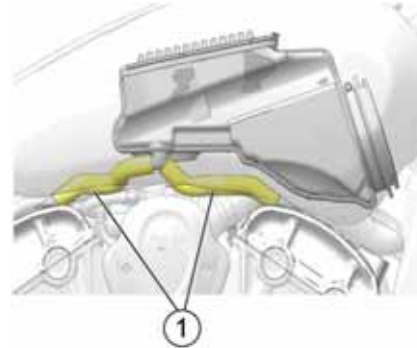

MAINTENANCE

EVAPORATIVE EMISSION CONTROL SYSTEM (CALIFORNIA MODELS)

1. Inspect all evaporative emission control system hoses and connections. Make sure all connections are tight and locked.
2. The canister C is located under the mid frame. Make sure it is securely fastened to the mounting bracket.
3. Inspect connections at the evaporative emissions canister to be sure they are secure.

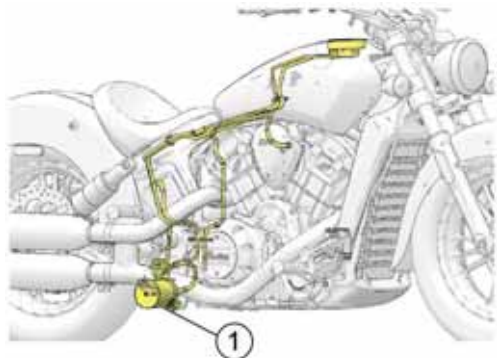

FUEL SYSTEM COMPONENTS

1. Inspect fuel hoses for cracks or damage.
2. Inspect hose connections at the fuel tank and at the fuel rail for dampness or stains from leaks.
3. The fuel system is under pressure and caution must be used when inspecting and servicing the fuel system. See the *INDIAN MOTORCYCLE Service Manual* or an authorized INDIAN MOTORCYCLE dealer or other qualified dealer.

THROTTLE CONTROL INSPECTION

1. With the engine OFF, rotate the throttle control grip fully open and then release it. It should rotate smoothly from the rest position to the completely open position. It should return to the rest position quickly when released.
2. Repeat the twist and release process with the handlebars turned fully *right* and fully *left*.
3. Service the throttle system if throttle operation is not smooth or if throttle grip does not return properly. See the *INDIAN MOTORCYCLE Service Manual* or an authorized INDIAN MOTORCYCLE dealer or other qualified dealer.

SIDESTAND LUBRICATION

Periodically lubricate the sidestand bushing. See page 50 for sidestand inspections.

MECHANICAL CLUTCH LEVER FREEPLAY

1. The clutch cable adjuster nut Q is located along the lower right frame. While holding the clutch cable, slide the rubber protective cover away from the lock nut. Loosen the lock nut.

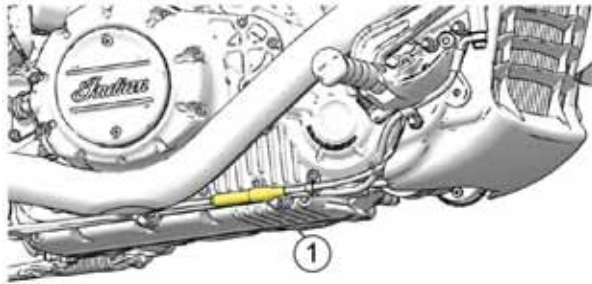

2. While holding the cable, turn the cable adjuster inward or outward until clutch lever freeplay is 0.5-1.5 mm.
3. While holding the cable, tighten the adjuster lock nut securely.



4. Verify that the safety switch activates properly. The engine should not start in gear with the clutch lever W released.

TIP: The starter interlock switch is dependent on the clutch lever freeplay being set correctly to ensure activation of the clutch safety switch.

MAINTENANCE

MECHANICAL CLUTCH LEVER LUBRICATION

1. Remove the clutch lever pivot nut Q and screw W . Disconnect the clutch cable e from the clutch lever.

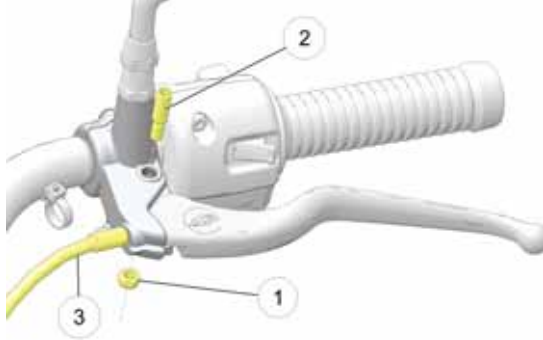

2. Remove any old grease and dirt from the lever and housing. Lubricate the clutch lever and pivot screw with moly assembly grease or all-purpose grease.
3. Reconnect the clutch cable. Hold the screw down and tighten the nut.

TORQUE: 96 in-lbs (10.8 Nm)

4. Adjust clutch lever freeplay. See page 85.
5. Tighten the adjuster nut and slide the protective cover over the adjuster.

MECHANICAL CLUTCH CABLE LUBRICATION

Lubricate control cable barrel ends at the intervals recommended in the Periodic Maintenance Table on page 67.

NOTICE: The clutch cable is factory-lubricated. Additional lubrication could be detrimental to cable performance. Replace the clutch cable assembly if binding or sticking occurs. **DO NOT** lubricate between the cable and sheath.

Verify proper routing and smooth movement. Inspect for damage to the external casing, and inspect exposed cable wire for fraying, kinks or corrosion. Replace any damaged, sticky or sluggish cable.

1. Disconnect the cable at the clutch lever and at the primary cover.
2. Lubricate the barrel ends Q with all-purpose grease.
3. Reconnect the cable and adjust freeplay as needed.

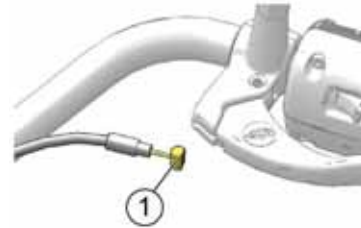

REAR BRAKE PEDAL

1. Lubricate the pivot bushing at the intervals recommended in the Periodic Maintenance Table on page 67. Also lubricate any time binding is evident. Use all-purpose grease.
2. Inspect brake pads as outlined on page 90.

BRAKE HOSES/CONNECTIONS

Inspect all brake hoses and connections for dampness or stains from leaking or dried fluid. Tighten any leaking connections and replace components as necessary. See the *INDIAN MOTORCYCLE Service Manual* or an authorized INDIAN MOTORCYCLE dealer or other qualified dealer.

BRAKE FLUID PRECAUTIONS

WARNING! Using the wrong fluid or allowing air or contaminants into the fluid system can damage the system seals or result in a malfunction that could lead to serious injury or death. Use only DOT 4 brake fluid from a sealed container.

Do not operate the front brake with the reservoir cover removed. Fluid could overflow from the reservoir and allow air to enter the system. Air in the brake system could cause the brakes to malfunction.

An over-full reservoir may cause brake drag or brake lock-up, which could result in serious injury or death. Maintain brake fluid at the recommended level. Do not overfill.

NOTICE: Brake fluid will damage painted surfaces and plastic parts. Always clean spilled brake fluid immediately with water and a mild detergent.

MAINTENANCE

REAR BRAKE FLUID

Change the brake fluid at the intervals recommended in the Periodic Maintenance Table on page 67. Always add brake fluid from a new, unopened container. Always use the recommended fluid. See page 122.

1. Position the motorcycle on level ground in the fully upright position.
2. The rear brake fluid reservoir is located near the rear brake pedal. View the reservoir from the right side of the vehicle.
3. Wipe the fluid container and the area around the reservoir cover with a clean cloth.
4. If the fluid level is low, inspect brake pads as outlined on page 90. If pads are not worn beyond the service limit, inspect the brake system for leaks.
5. Remove the cover and diaphragm. The fluid level should be above the minimum indicator mark on the reservoir body Q . Add brake fluid as needed. *Do not overfill.*

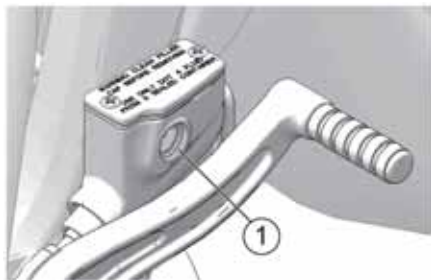

6. Reinstall the cover and diaphragm. Tighten the cover screws.

TORQUE: 13 in-lbs (1.5 Nm)

7. Wipe away any fluid spills. Check for signs of brake fluid leaks around hoses, fittings, reservoir, and brake calipers.

FRONT BRAKE LEVER

1. Lubricate the pivot pin \odot and brake lever hinge points ω at the intervals recommended in the Periodic Maintenance Table on page 67. Also lubricate any time binding is evident. Use all-purpose grease.

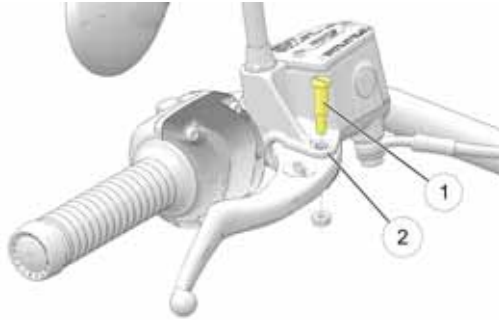

2. Inspect brake pads as outlined on page 90.

FRONT BRAKE FLUID

Change the brake fluid at the intervals recommended in the Periodic Maintenance Table on page 67.

Do not attempt to change the anti-lock brake system fluid. Please see your dealer for this service.

Always add brake fluid from a new, unopened container. Always use the recommended fluid. See page 122.

1. Position the motorcycle on level ground in the fully upright position. Position the handlebars so that the fluid reservoir is level. Wipe the fluid container and the area around the reservoir cover with a clean cloth.
2. If the fluid level is low, inspect brake pads as outlined on page 90. If pads are not worn beyond the service limit, inspect the brake system for leaks.
3. To add fluid, remove the reservoir cover screws. Remove the cover \odot and diaphragm ω .

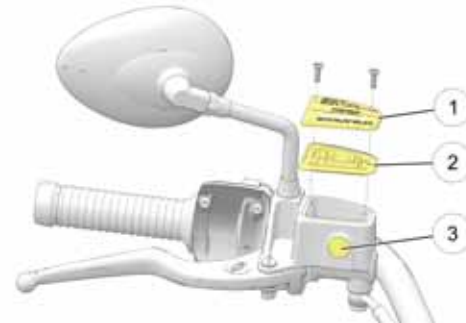

4. The fluid level should be above the minimum indicator mark in the sight glass \odot . Add brake fluid as needed. *Do not overfill.*
5. Reinstall the diaphragm, cover and screws.

TORQUE: 13 in-lbs (1.4 Nm)

MAINTENANCE

6. Wipe away any fluid spills. Check for signs of brake fluid leaks around hoses, fittings, reservoir and brake calipers. Check for deterioration of hoses.

BRAKE PADS

Inspect each front brake pad on both sides of the front disc. Inspect each rear brake pad on both sides of the rear disc.

When checking brake pad friction material thickness, check each brake caliper for dampness or stains from leaking or dried brake fluid. If inspection reveals signs of fluid leakage, do not operate the vehicle. See your dealer for service.

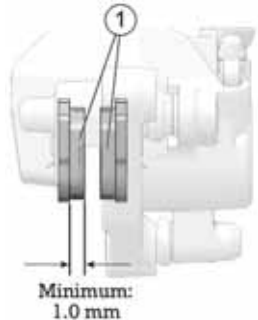

Use an inspection mirror, positioned at the front side of the caliper, to view the friction material.

Replace brake pads when the thinnest point of the friction material has worn to 1.0 mm. Please see your dealer for this service.

TIP: After replacing pads, allow up to 250 miles (500 km) of operation in urban driving conditions (not highway cruising) to allow pads to mate with new rotors. Brakes should be used frequently. During this time brake performance will be less effective. Avoid using brakes harshly unless in an emergency. Brake efficiency will gradually increase during this seating period.

BRAKE DISC INSPECTION/CLEANING

1. Inspect brake discs for nicks, scratches, cracks or other damage. Inspect the thickness of each brake disc at four or more locations around the disc. If any disc is worn to the minimum thickness at the thinnest point, or if a disc is damaged, see your dealer for replacement.

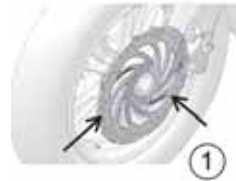

2. Clean discs if minor squeaks develop due to dirt or dust. Apply brake cleaner to a clean shop towel and wipe the discs. DO NOT allow brake cleaner to contact painted or plastic parts. Read all precautions on the label.

ANTI-LOCK BRAKE SYSTEM (ABS) TONE RING/SENSOR INSPECTION (IF EQUIPPED)

1. Visually inspect for damaged teeth on the front and rear ABS tone rings Q. Inspect for nicks and dents on the face of the teeth. The teeth edges should be consistent in appearance. If a tone ring is damaged, see your dealer for replacement as soon as possible.

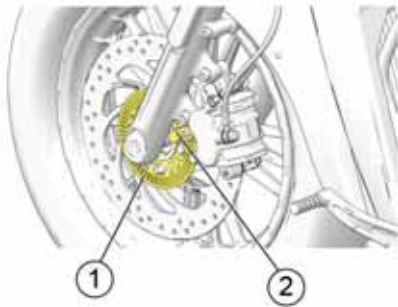

2. Inspect for debris adhering to the end of the wheel speed sensors W. If contamination is observed, or if you are unable to visually inspect, slide a thin towel across the face of the sensor between the sensor and the tone ring to remove any potential debris.

WHEEL INSPECTION

Inspect both wheels for cracks or damage and replace damaged wheels promptly. Do not operate the motorcycle if wheels are damaged or cracked. See the *INDIAN MOTORCYCLE Service Manual* or an authorized INDIAN MOTORCYCLE dealer or other qualified dealer.

WHEEL ALIGNMENT

Inspect rear wheel alignment at regular service intervals, whenever the rear wheel is removed and when the rear drive belt is adjusted. Please see your dealer for this service.

MAINTENANCE

FRONT WHEEL INSTALLATION

If the front wheel is removed for any reason, it must be reinstalled in the correct rotating direction.

Clean all wheel components before installation. Apply a light coat of all-purpose grease to the axle and both spacers.

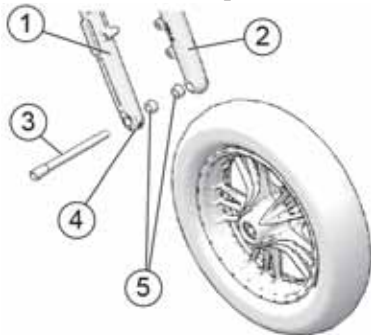

Q Right Fork Tube

W Left Fork Tube

E Axle Bolt 52 ft-lbs. (70 Nm)

r Pinch Bolt 18–19 ft-lbs. (24.4–25.7 Nm)

t Wheel Spacers

TIRES

WARNING! Operating the motorcycle with incorrect tires, incorrect tire pressure or excessively worn tires could cause loss of control or accident. Underinflation can cause a tire to overheat and result in a tire failure. Always use the correct size and type of tires specified by INDIAN MOTORCYCLE for your vehicle. Always maintain proper tire pressure as recommended in the rider's manual and on safety labels.

TIRE REPLACEMENT

Tires, rims, innertubes and air valves must be correctly matched to wheel rims. Use only the proper size tires specified with the same or higher load ratings. INDIAN MOTORCYCLE-recommended tires provide proper clearance between fenders, swingarm, drive belts and other components. See the Specifications on page 117.

On models equipped with innertubes, innertubes **MUST** be replaced with new innertubes when tires are replaced. Use only the proper size innertubes.

WARNING! Mismatched tires, rims and air valves may result in damage to the tire bead during mounting or may allow the tire to slip off the rim, possibly resulting in tire failure.

TIRE CONDITION

Inspect the tire sidewalls, road contact surface, and tread base for cuts, punctures, and cracking. Replace damaged tires immediately. See the *INDIAN MOTORCYCLE Service Manual* or an authorized INDIAN MOTORCYCLE dealer or other qualified dealer.

TIRE TREAD DEPTH

Replace any tire with a tread depth of less than 1/16 inch (1.6 mm).

Tread wear indicators are located in at least six places on the tread circumference and become visible at a tread depth of approximately 1/16 inch (1.6 mm). The tread wear indicators appear as a solid band across the tread.

You may also use a depth gauge or an accurate ruler to measure the depth of the center tire tread on both front and rear tires.

MAINTENANCE

TIRE PRESSURE

Always check and adjust tire pressure when tires are cold. Do not adjust tire pressure immediately after riding. Wait at least 3 hours after riding to check pressure. If pressure checked and adjusted while tires are warm, the pressure will drop as tires cool and result in underinflation.

Adjust tire pressure as recommended for the total weight of your intended load (see chart below). For more information, refer to the manufacturing information label located on the front frame downtube. See page 20.

WARNING! Do not exceed the maximum recommended inflation pressure to seat the bead. Tire or rim failure may result.

LOCATION	SIZE	BRAND	TYPE	RECOMMENDED PRESSURE	
				LOADS UP TO 200 LBS. (91 KG)	LOADS UP TO VEHICLE'S MAXIMUM LOAD CAPACITY
Front	130/90-16 72H	Kenda	K673F	36 psi (248 kPa)	36 psi (248 kPa)
Rear	150/80-16 71H	Kenda	K673	40 psi (276 kPa)	40 psi (276 kPa)

SPARK PLUGS

See your dealer for spark plug inspections and replacement at the intervals specified in the Periodic Maintenance Table (page 67).

SPARK PLUG SPECIFICATIONS	
Spark Plug Type	NGK MR7F
Spark Plug Gap	.030 inch (0.80 mm)
Spark Plug Torque	7.5 ft-lbs (10 Nm)

SEAT REMOVAL/INSTALLATION

TIP: Use caution to avoid contact with the fuel tank when removing the seat.

1. Grasp the front edge of the seat and pull upward abruptly to disengage the seat base grommet from the seat mount stud.

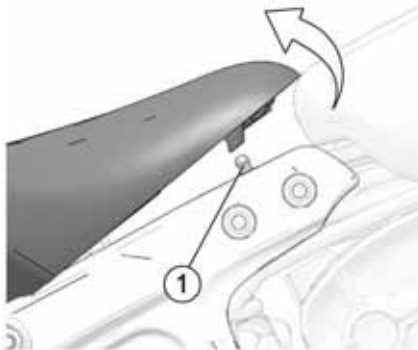

2. Lift the seat and pull it slightly rearward to disengage the seat base from the rear retainer.



3. To reinstall the seat, make sure the seat base engages the rear retainer, then press downward firmly at the front edge of the seat to engage the stud to the seat base grommet.

WARNING! If the seat is not aligned in a straight-ahead position, the grommet is not engaged to the stud. Make sure the grommet is fully engaged to the stud before operating.

MAINTENANCE

HEADLIGHT AIM INSPECTION

On high beam, the center of highest intensity \odot (appearing as a diamond shape) should be 7.5 in. (19 cm) lower than the headlamp bulb and centered straight ahead at 25 feet (7.6 m).

1. Verify that tire pressure is at specification. See page 94.
2. Verify that rear suspension ride height (preload) is at specification. See page 80.
3. Position the motorcycle on a level surface with the headlight 25 feet (7.6 m) from a wall.
4. With the operator and passenger (if applicable) on board, bring the motorcycle to the fully upright position.
5. Start the engine and switch the headlamp to high beam. Observe the headlight aim on the wall.
6. Make any necessary adjustments to headlight aim. See page 96.

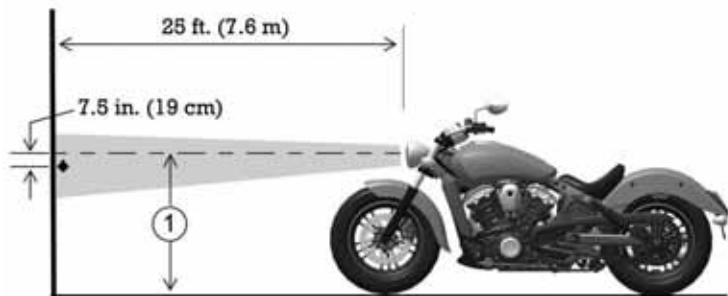

HEADLIGHT AIM ADJUSTMENT

1. To adjust the headlamp vertically, loosen the housing mount fastener \odot and pivot the housing upward or downward. Tighten the fastener.

TORQUE: 35 ft-lbs (47.5 Nm)

2. To adjust the headlamp horizontally, loosen the headlight mounting bolt ∇ and pivot the headlight to the left or right. Tighten the bolt.

TORQUE: 18 ft-lbs (24.4 Nm)

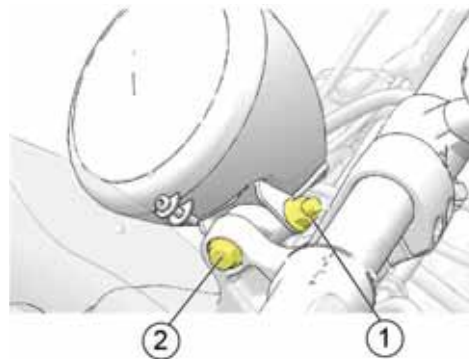

HEADLIGHT LAMP REPLACEMENT

1. Remove the headlight retaining screw Q_1 .
2. Lift the headlight upward and remove it from the base W .
3. Disconnect the wire harness e .
4. Remove the rubber boot from the rear of the headlight.
5. Squeeze the bulb retainer r and move it away from the bulb. Remove the bulb.

TIP: Avoid touching a halogen lamp with bare fingers. Oil from your skin leaves a residue, causing a hot spot that will shorten the life of the lamp. If a lamp is touched, clean it thoroughly with denatured alcohol.

6. Install the new bulb t and secure the retainer.
7. Reinstall the rubber boot, making sure it seals around the bulb and headlight.
8. Connect the wire harness.
9. Reinstall the headlight to the base and tighten the screw.

TORQUE: 36 in-lbs (4.1 Nm)

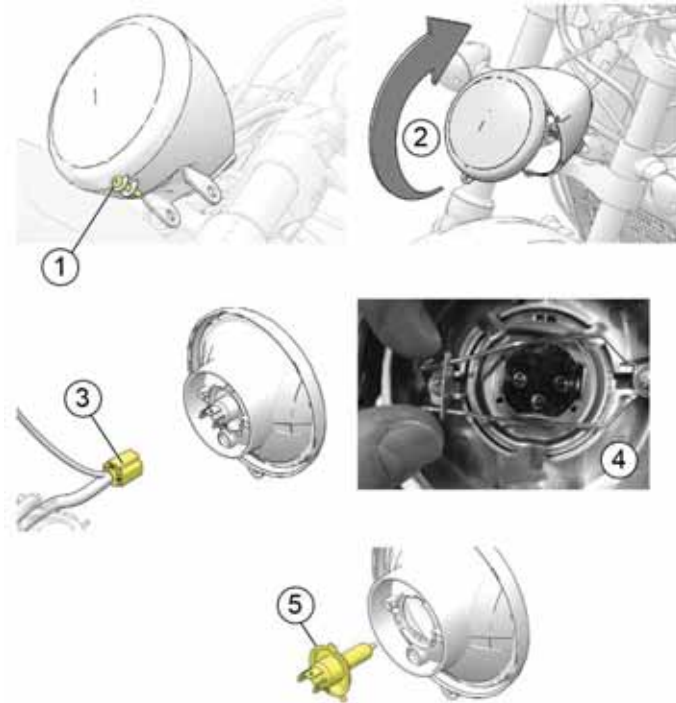

MAINTENANCE

BATTERY

The motorcycle battery is a sealed, maintenance-free battery. Do not remove the battery cap strip for any reason. Keep the battery connections clean and tight at all times.

WARNING! Battery electrolyte is poisonous. It contains sulfuric acid. Serious burns can result from contact with skin, eyes or clothing.

External: Flush with water.

Internal: Drink large quantities of water or milk. Follow with milk of magnesia, beaten egg, or vegetable oil. Call physician immediately.

Eyes: Flush with water for 15 minutes and get prompt medical attention.

Batteries may produce explosive gases.

- Keep sparks, flame, cigarettes, etc. away.
 - Ventilate when charging or using in an enclosed space.
 - Always shield eyes when working near batteries
 - **KEEP OUT OF REACH OF CHILDREN.**
-

BATTERY REMOVAL

WARNING! Improperly connecting or disconnecting battery cables can result in an explosion and cause serious injury or death. When removing the battery, always disconnect the negative (black) cable first. When reinstalling the battery, always connect the negative (black) cable last.

1. Remove the seat. See page 95.
-

2. Remove the fuse box from the frame of the motorcycle. Use care to avoid pulling or stretching wires. See page 99. Fold the wires to the right rear side of the motorcycle.
3. Remove the battery hold-down strap. **Tool:** 10 mm wrench
4. Remove the negative (-) battery cable  from the battery terminal. Position the cable well clear of the terminal. **Tool:** 10 mm wrench

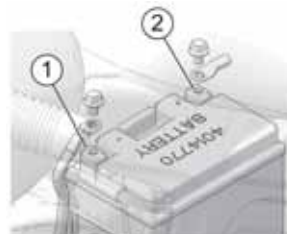

5. Remove the rubber cover from the positive (+) battery cable and remove the cable  from the terminal. Position the cable well clear of the terminal.
6. Tilt the battery slightly rearward, then lift it away from the motorcycle.

BATTERY INSTALLATION

WARNING! Improperly connecting or disconnecting battery cables can result in an explosion and cause serious injury or death. When removing the battery, always disconnect the negative (black) cable first. When reinstalling the battery, always connect the negative (black) cable last.

NOTICE: Do not remove the battery cables while the engine is running. Doing so may damage the Electronic Control Unit (ECM). Take great care not to reverse the battery leads when installing the battery. Reverse power applied to the ECM will damage it instantly.

1. Inspect the battery box for damage. Be sure pads are in good condition and properly located.
 2. Make sure cable ends and battery terminals are clean. Apply a light film of dielectric grease to the terminal bolt threads.
 3. Carefully position the battery into the battery box with the negative (-) terminal toward the front of the motorcycle.
 4. Make sure the positive (+) cable is routed horizontally and perpendicular to the long side of the battery. Connect the positive (+) cable to the positive (+) battery terminal.
-

TORQUE: 45 in-lbs (5 Nm)

5. Install the negative (-) ground cable last.
-

TORQUE: 45 in-lbs (5 Nm)

6. Reinstall the battery hold-down strap.
-

TORQUE: 96 in-lbs (10.8 Nm)

7. Reinstall the seat. See page 95.
-

BATTERY CHARGING

If your motorcycle will not be used for a period of four (4) weeks or longer, a maintenance charger should be connected to the battery. A maintenance charger can be purchased through your authorized INDIAN MOTORCYCLE dealer or other qualified dealer.

1. Following the charger manufacturer's instructions, use a battery charger designed for use with 12-volt batteries. The charger should have a maximum charging rate of 1.8 amps. Charge the battery for approximately 10 hours at a rate of 1.8 amps. If you use a taper or trickle charger, it will take longer to charge the battery.
2. After charging the battery, allow the battery to sit 1-2 hours before checking the state of charge with a DC volt meter. The charge should be a minimum of 12.5 DC volts. Repeat the charging cycle if the charge is less than 12.5 DC volts. Replace the battery if it fails to reach 12.5 volts after the second charge.

FUSE REPLACEMENT

The standard fuse box is located under the seat. This fuse box houses all standard service fuses and the automatic circuit breakers. Fuse application and size are provided on a label on the fuse box cover.

The main vehicle fuse Q is located on the wiring harness at the rear of the battery. Remove the fuse cap to inspect or replace this fuse.

NOTICE: Use fuses with the recommended amperage to avoid damage to the electrical system.

MAINTENANCE

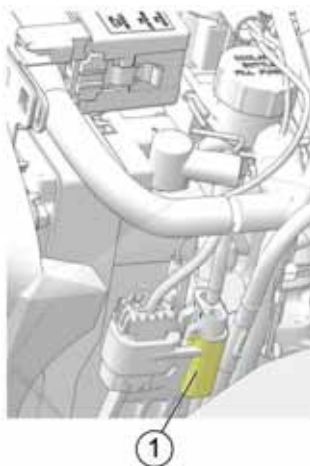

1. Remove the seat. See page 95.
2. Press the fuse box release tab ψ inward and slide the fuse box rearward to remove it from the bracket. Use care to avoid pulling or stretching the wires.
3. Bend the cover clips \ominus slightly away from the cover to remove the cover.

TIP: Use the fuse puller provided in the tool kit to remove a fuse.

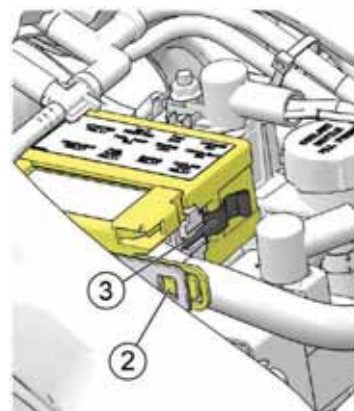

4. After replacing a fuse, reinstall the fuse box cover.
5. Reinstall the fuse box to the bracket. Make sure the release tab engages.
6. Reinstall the seat.

ELECTRICAL PRECAUTIONS

Be aware of the following precautions regarding the electrical system to avoid disruption of electrical signals and possible system malfunction.

- DO use ONLY genuine INDIAN MOTORCYCLE parts and accessories designed for your model, and follow the instructions provided.
- DO use the accessory power jack provided (if equipped).
- If it is necessary to provide power to an item that does not use one of the previously mentioned power jacks, connect to the “hot” side of the starter solenoid with an inline fuse, and connect the ground wire to the chassis ground located at the left rear section of the frame under the seat.
- DO NOT splice or cut any wires.
- DO NOT tap in to any power or ground on the motorcycle unless specifically directed to do so by the INDIAN MOTORCYCLE instructions that come with the kit.
- DO NOT back-probe electrical connectors on the vehicle unless directed to do so by the *INDIAN MOTORCYCLE Service Manual*.
- DO NOT power any accessories from the diagnostic connector.

EXHAUST SYSTEM INSPECTION

Check the exhaust system for stains from leaking exhaust gasses. Replace damaged or leaking exhaust gaskets. Check all exhaust system fasteners. Tighten loose clamps and fasteners. Do not overtighten. See the *INDIAN MOTORCYCLE Service Manual* or an authorized INDIAN MOTORCYCLE dealer or other qualified dealer.

ELEVATING THE MOTORCYCLE

WARNING! Serious injury or death can occur if the motorcycle tips or falls. Make sure the motorcycle will not tip or fall while elevated or while on the sidestand.

Some procedures require raising the motorcycle to remove weight from the component being inspected. Elevate the motorcycle by placing a stable, flat platform jack or lift mechanism on a firm, flat surface and lifting under the engine crankcase. The platform should be a minimum of 12 inches (30 cm) square. DO NOT attempt to lift the motorcycle without proper equipment. Always secure the motorcycle properly before lifting so it cannot tip or fall when elevated.

MAINTENANCE

ROAD TEST

Before returning the motorcycle to regular use, perform a road test in a safe area. Pay special attention to the proper fit and operation of all serviced components.

Make any corrections or additional adjustments promptly to ensure safe, reliable and enjoyable vehicle performance.

FASTENER INSPECTION

1. Inspect the entire motorcycle chassis and engine for loose, damaged or missing fasteners. Tighten loose fasteners to the proper torque. See the *INDIAN MOTORCYCLE Service Manual* or an authorized INDIAN MOTORCYCLE dealer or other qualified dealer.
2. Always replace stripped, damaged or broken fasteners before riding. Use genuine INDIAN MOTORCYCLE fasteners of equal size and strength.

FASTENER TORQUES

Some procedures and fastener torques are not listed in this manual. See the *INDIAN MOTORCYCLE Service Manual* or an authorized INDIAN MOTORCYCLE dealer or other qualified dealer.

TROUBLESHOOTING

For your personal safety, do not attempt inspection or repairs not fully described in this rider's manual. Contact an authorized dealer for service if you cannot determine the cause of a problem or if the inspection/repair exceeds your mechanical ability or tool resources. Do not perform any inspection or repair with the engine running.

ENGINE CRANKS BUT WILL NOT START

POSSIBLE CAUSE	POSSIBLE REMEDY/ACTION
Low fuel	Verify fuel level
Fuel pump doesn't operate	Turn engine STOP switch to RUN. Turn the ignition key on. The fuel pump should run momentarily and then stop. Check the fuel pump/ignition circuit breaker. See page 99.
Battery voltage is too low	Fully charge the battery. See page 99.
Fouled spark plug(s)	Please see your dealer.
Low compression	Please see your dealer for an engine compression test.

STARTER MOTOR CLICKS, DOES NOT TURN OR TURNS SLOWLY

POSSIBLE CAUSE	POSSIBLE REMEDY/ACTION
Engine stop/run switch is in stop position	Place switch in RUN position.
Discharged battery	Fully charge the battery. See page 99.
Loose or corroded battery cables	Inspect battery cables.
Transmission is in gear	Shift transmission into neutral or pull the clutch lever in to disengage the clutch. See page 57.

MAINTENANCE

ENGINE STARTS BUT MISSES OR RUNS POORLY

TIP: Turn engine OFF before inspecting any of these items.

POSSIBLE CAUSE	POSSIBLE REMEDY/ACTION
Discharged battery	Fully charge the battery. See page 99.
Loose or corroded battery cables	Inspect battery cables and connections.
Fouled spark plug(s)	Please see your dealer.
Contaminated fuel	Inspect fuel for water/contamination. Please see your dealer.
Engine oil level incorrect or wrong oil type	Inspect level and quality of oil. See page 44.
Loose, broken, shorted ignition coil wires	Inspect coil primary wires. Please see your dealer.
Air intake restricted	Inspect air filter. See page 73.
Intake leaks	Inspect air box, crankcase breather hoses, throttle body and intake boot joints.

SHIFTING DIFFICULTIES OR HARD TO FIND NEUTRAL

POSSIBLE CAUSE	POSSIBLE REMEDY/ACTION
Clutch damage	Replace clutch.
Clutch cable not adjusted properly	Please see your dealer for inspection and adjustment.
Shift linkage not adjusted properly	Please see your dealer for inspection and adjustment.
Incorrect oil or oil in poor condition	Replace the oil with the recommended oil.

ENGINE OVERHEATING

POSSIBLE CAUSE	POSSIBLE REMEDY/ACTION
Debris lodged in radiator screen	Inspect and clean the screen.
Plugged radiator	Use a garden hose to flush any debris from the radiator fins. DO NOT use a high pressure washer, which can damage the radiator fins.
Blocked fan	Inspect fan, remove any blockage.
Fan doesn't operate	Please see your dealer.
Low coolant	Allow the engine to cool before checking coolant level. See page 72.
Air in cooling system	Please see your dealer.

BATTERY CHARGING RATE LOW OR BATTERY DISCHARGES

POSSIBLE CAUSE	POSSIBLE REMEDY/ACTION
Loose/Corroded Charging Circuit Connection	Check/clean battery cable connections. Check/clean charging circuit connections. Please see your dealer.
Accessory Load Exceeds Charge Rate	Limit accessory operation when the engine is off.
Improperly Wired Accessory (Current Draw)	Please see your dealer to check charging system output and current draw.

MAINTENANCE

BRAKE NOISE/POOR BRAKE PERFORMANCE

TIP: See your dealer if brake performance does not return after these inspections.

POSSIBLE CAUSE	POSSIBLE REMEDY/ACTION
Dust/Dirt On Brake Disc(s)	Clean disc. See page 90.
Worn Pads Or Disc/Brake Disc Damage	Inspect pads. See page 90.
Brake Fluid Level Low Or Fluid Contaminated	Inspect fluid level/fluid condition. See page 47 and page 48.

ANTI-LOCK BRAKE LIGHT REMAINS ILLUMINATED OR ILLUMINATES INTERMITTENTLY

POSSIBLE CAUSE	POSSIBLE REMEDY/ACTION
Blown fuse	Check the fuses. See page 99.
Loose or damaged pulse ring	Inspect pulse ring for looseness or chipped teeth.
Debris lodged in components	Inspect wheel speed sensor and pulse ring for debris.
Damage caused by debris	Inspect wheel speed sensor for cracked housing.
Damaged components	See service manual or authorized dealer.

CLEANING AND STORAGE

CLEANING PRODUCTS

This section provides tips on the very best way to clean, polish and preserve every surface of your beautiful new INDIAN motorcycle. We recommend the use of our new INDIAN MOTORCYCLE cleaning and polishing products and accessories, which have been specially designed to offer the best care possible for your INDIAN motorcycle.

In addition to the products recommended in this section for cleaning and polishing, INDIAN MOTORCYCLE also has specialty products for:

- enhancing black and silver engines
- cleaning engines, tires and wheels
- removing brake dust

After cleaning the motorcycle, inspect for damage to the painted surfaces. Chips or scratches should be repaired promptly to prevent corrosion.

For Matte Clear Coat Finish Care, see page 108.

For Gloss Clear Coat Finish Care, see page 109.

For more information, or for answers to your cleaning and detailing questions, please see your INDIAN MOTORCYCLE dealer.

WASHING THE MOTORCYCLE

NOTICE: Do not use pressurized water to wash the motorcycle. Water may seep in and deteriorate wheel bearings, brake caliper assemblies, brake master cylinders, electrical connectors, steering head bearings, and transmission seals. Do not direct any water stream at air intakes, exhaust outlets, electrical connectors or audio system speakers. Electrical components may be damaged by water. Do not allow water to contact electrical components or connectors

1. Before washing, make sure exhaust pipes are cool. Cover each pipe opening with a plastic bag secured with a strong rubber band. Check that the spark plugs, spark plug wire caps, oil fill cap and fuel caps are properly seated.
2. Do not use abrasive cleaners.
3. Rinse off as much dirt and mud as possible with water running at low pressure. Use as little water as possible when washing near the air intake or the exhaust pipe openings. Dry these components thoroughly before using the motorcycle.
4. Clean the front fork tubes thoroughly to reduce fork seal wear and leakage.
5. After washing, remove the rubber bands and plastic bags from the exhaust pipes. Start the engine and let it idle for a few minutes.
6. Make sure the brakes are functioning properly before riding.

CLEANING AND STORAGE

WINDSHIELD CARE (IF EQUIPPED)

Clean the windshield with a soft cloth and plenty of warm water. Dry with a soft clean cloth. Remove minor scratches with a high-quality polishing compound designed for use on polycarbonate surfaces.

NOTICE: Brake fluid and alcohol will permanently damage the windshield and some types of thread-locking agents. Do not use glass cleaners, water or soil repellents, and petroleum or alcohol based cleaners on the windshield, as these products can damage the windshield.

MATTE CLEAR COAT FINISH CARE

Matte finish products are prone to trapping dirt, oils and other contaminants. Always clean this type of finish with warm water and a mild dish-washing detergent. Use a soft sponge to gently rub the surface, then rinse with clean warm water. For stubborn stains such as grease or oil, use a citrus-based cleaner. Spray the cleaner onto the area and rub gently with a soft sponge. Allow the cleaner to sit for a couple of minutes, then rinse well with clean warm water. Repeat as needed.

NOTICE: Never use a polishing/buffing wax or any sponge that has an abrasive surface when cleaning a matte finish. These products will buff the matte surface of the finish and result in a glossy finish. Never clean matte finishes with a pressure washer, as this will further imbed contaminants into the clear coat and may damage labels and decals.

GLOSS CLEAR COAT FINISH CARE

The Axalta Sports and Equipment Finish System was used to provide the original gloss finish on your motorcycle. This finish system provides superior protection against the elements. To maximize the benefits of this system, use the following guide to care for the gloss finish on your motorcycle.

- During the first 30 days, when the finish is still fresh, clean the motorcycle with a water rinse only.
 - Do not wax the motorcycle for the first 60 days. Doing so can cause loss of the gloss. After 60 days, use only waxes designed for new clear coat finishes.
 - Do not use pressurized water to wash the motorcycle. When paint is still fresh, pressurized water could damage the finish. If using a pressure washer is unavoidable, keep the spray nozzle at least 24 inches (60 cm) away from the surface of the motorcycle.
 - Wash your motorcycle often, especially when exposed to salty, dusty, acidic or alkaline environments.
 - Use warm or cool water and a soft cloth for cleaning.
 - Use soaps that are non-abrasive and have a neutral pH (non acidic/non alkaline detergents).
- Do not use solvent-based solutions.
 - Do not use a dry cloth to remove dust.
 - Do not use a stiff bristle brush, which can scratch the surface.
 - Do not wash with extremely hot water.
 - Do not wash the motorcycle while the surface is hot and avoid washing the motorcycle in the hot sun. Minerals in the water may be difficult to remove once dried on the surface of the motorcycle.
 - Do not allow spilled gasoline, motor oil or brake fluid to stand on the paint. Remove these substances immediately by rinsing with water. Use a soft cloth to absorb any remaining residue and dab dry.
 - To remove bug remnants or road tar, use only products that are specifically designed for this purpose. Follow the product manufacturer's recommendations to prevent potential damage to the finish. Follow with a wash using the methods described in this section.
 - Always brush away any ice or snow, do not scrape off.
 - Chips or scratches should be repaired promptly to prevent corrosion.

CLEANING AND STORAGE

LEATHER CARE

LEATHER FACTS

Leather is a natural product and will exhibit qualities inherent in a natural material. Fading, wrinkles, grain changes, creases and small marks are assurance that this material is not man-made. As the product is used, each leather product will exhibit tarnish from use. Regular care will help keep premium leather products looking their best.

EXPOSURE TO SUN

There are many environmental elements that will contribute to the aging of leather products. Regular exposure to the sun, along with heat from the sun and exhaust system or engine components, may rapidly fade the leather. Heat from the sun will dry the leather, potentially causing it to crack. Periodic application of INDIAN MOTORCYCLE Leather Care Dressing will replace the oils, maintaining the leather's natural surface. Periodic use of the Tan Leather Restore Kit will help restore and maintain the oil-tanned color and finish to help keep it looking its best.

EXPOSURE TO MOISTURE

If leather is exposed to moisture, wipe down the leather products and allow them to dry naturally. Do not attempt to accelerate the drying process by using heat. Heating the leather will remove the natural oils and cause it to dry out and crack. Whenever possible, take steps to protect the leather from exposure to moisture.

NOTICE: The leather used on INDIAN motorcycles is an all-natural product; exposure to moisture will result in structural changes to the material, causing permanent damage. Regular usage of INDIAN MOTORCYCLE Leather Care Dressing will help prevent this type of damage.

EXPOSURE TO DIRT/DUST

Leather items on motorcycles can get extremely dirty with normal use. It is acceptable to wipe down leather products with a sponge and clean water, especially after a long ride. If extremely dirty, use a small amount of mild soap in the water and follow with a clean water rinse.

LEATHER CARE DRESSING

INDIAN MOTORCYCLE Leather Care Dressing is a leather conditioner formulated to restore many of the oils that are lost from leather due to exposure to environmental elements. This conditioner is suitable for all oil-tanned leather on your INDIAN motorcycle, but it should never be used on suede.

This leather care dressing will also restore some of the color lost through natural aging and now includes UV protection. The rate of aging depends on how often the motorcycle is used, how it is stored, and weather conditions. While visible signs of aging are more noticeable on natural leather, lack of care may cause non-warrantable damage to both natural and black leather.

APPLICATION

Apply Leather Care Dressing as part of a regular maintenance regime, such as polishing chrome and washing painted surfaces. Apply this treatment at least one time per month. Apply more often if the motorcycle is regularly exposed to the elements or parked in the sun.

1. Wipe down leather with a sponge and clean water.
2. Wipe down leather with a dry towel and allow it dry at room temperature. Do not use heat to accelerate drying time.
3. With a clean cloth, lightly rub the dressing into the leather and wipe off any excess. Be cautious not to allow droplets or globs of the treatment to sit on an area of the leather as that area will darken. For better results, use a straight wiping motion rather than a tight swirling motion. Lighter areas may need more treatment applied to darken them.
4. Allow the treatment to dry before riding (typically one hour).

CLEANING AND STORAGE

LEATHER CARE FREQUENTLY ASKED QUESTIONS

Q. CAN I USE SHOE POLISH TO RESTORE LEATHER COLOR?

A. Shoe polish should not be used on the leather items on your INDIAN motorcycle. Shoe polish contains a dye that can damage the leather and may leave residue on clothing.

Q. WHAT SHOULD I USE TO TREAT THE BLACK LEATHER THAT CAME ON MY INDIAN MOTORCYCLE?

A. INDIAN MOTORCYCLE Leather Care Dressing is suitable for all oil-tanned leather on your INDIAN motorcycle. Black leather uses a different tanning process and may not require application of the dressing as often.

Q. WHAT SHOULD I USE ON MY LEATHER ACCESSORIES?

A. INDIAN MOTORCYCLE Leather Care Dressing is suitable for all oil-tanned leather on your INDIAN motorcycle, including accessories.

STORAGE AREA PREPARATION

Choose a dry, well-ventilated storage location, inside a garage or other structure if possible. The location should have a firm, flat surface and allow enough space for the motorcycle.

WARNING! Gasoline is highly flammable and explosive under certain conditions. Do not store the motorcycle in any area (in home or garage) where it could be near open flames, pilot lights, sparks or electric motors. Do not smoke in the storage area.

To best preserve tire condition:

- The storage area should have a relatively constant and moderate temperature.
- The storage surface should be free of oil and gasoline.
- The motorcycle should not be near a radiator or other heat source, or any type of electric motor.

CLEAN AND PROTECT THE MOTORCYCLE

To prepare the motorcycle for storage, begin by cleaning it as outlined on page 107. Polish chromed and other metal surfaces. Apply protectant to exposed rubber, vinyl and plastic parts. *Do not apply rubber protectant to the tire tread surfaces.*

FUEL STABILIZER

Add fresh fuel to fill the fuel tank and add fuel stabilizer. Do not overfill.

Ride the motorcycle or start and run the engine for 15 minutes in a well ventilated area to distribute the stabilizer throughout the fuel system.

TIRE INFLATION

Inflate the tires to normal pressure. See page 94.

ENGINE PROTECTION

Change the engine oil. See page 70.

COOLING SYSTEM

Check the coolant level and maintain as recommended by adding coolant to the recovery bottle. See page 72.

CLEANING AND STORAGE

BATTERY CARE

1. Remove the battery. See page 98.
2. Clean the battery terminals first with a wire brush to remove any loose deposits.
3. Wash the posts and the ends of the battery cables with a solution of one part baking soda to 16 parts water. Rinse with clean water and wipe dry.
4. Apply a thin film of dielectric grease to the posts and cable connectors.
5. Clean the outside of the battery with a solution of mild detergent and warm water.
6. Store the battery in a dry area with a temperature of 32° to 90° F (0° to 32° C).
7. While in storage, fully charge the battery once a month. See page 99.

MAINTENANCE DURING STORAGE

During extended storage periods, maintain tire pressure and battery voltage at the recommended levels.

RODENTS

Mice and other rodents are often the worst enemy of a stored motorcycle. If the motorcycle will be stored in an area where mice are a concern (particularly in rural areas, barns, sheds, etc.) be sure to take extra measures to deter their infestation. This may include placing a screen mesh over any intake or exhaust openings (just be sure to remember to remove them when you take the motorcycle from storage).

PARK AND COVER THE MOTORCYCLE

1. Park the motorcycle in its storage location. Block the frame to take some of the weight off the front and rear wheels.

TIP: Starting the motorcycle periodically during storage is NOT recommended. Water vapor is a by-product of the combustion process, and corrosion may result unless the engine is operated long enough to bring the oil and exhaust system to normal operating temperature.

2. Secure a plastic bag over the (cooled) exhaust outlets to prevent moisture from entering the exhaust system.
3. Cover the motorcycle with a cover made from a durable, breathable material designed for storage. Covering the motorcycle helps protect it from dust and other airborne materials. The cover must be of a breathable material to prevent moisture from building up on the motorcycle which can cause oxidation of metal surfaces.

REMOVAL FROM STORAGE

1. Install a fully charged battery.
2. Check the oil level. If the motorcycle was stored in an area subject to wide swings in temperature and humidity (such as outdoors), change the engine oil before starting the engine.

NOTICE: During storage, temperature and humidity changes can cause condensation to form in the crankcase and mix with engine oil. Running the engine with oil that contains condensation can cause engine damage.

3. Inspect the storage area for signs of fluid leaks. Identify and perform service to any leaking components.
4. Remove any intake or exhaust mesh covers installed for rodent protection.
5. Make sure the fuel tank is at least 3/4 full.
6. Perform the pre-ride inspections. See page 41.
7. Perform a road test. See page 102.
8. Wash and polish the motorcycle. Wax, polish or apply protectant to appropriate components.

SPECIFICATIONS

2017	INDIAN SCOUT	INDIAN SCOUT SIXTY
Dimensions (Dimensions and specifications may vary with features, options and accessories)		
Overall Length	91 in. (2311 mm)	91 in. (2311 mm)
Overall Width	34.6 in. (880 mm)	34.6 in. (880 mm)
Overall Height	47.5 in. (1207 mm)	47.5 in. (1207 mm)
Seat Height	Unladen 26.5 in. (673 mm) Laden 25.3 in. (643 mm)	Unladen 26.5 in. (673 mm) Laden 25.3 in. (643 mm)
Wheelbase	61.5 in. (1562 mm)	61.5 in. (1562 mm)
Ground Clearance	5.3 in. (135 mm)	5.3 in. (135 mm)
Rake (frame)/Trail	29°/4.7 in. (119.9 mm)	29°/4.7 in. (119.9 mm)
Weight		
Dry Weight (without fuel/fluids)	540 lbs. (245 kg)	538 lbs. (244 kg)
Wet Weight (with fuel/fluids)	560 lbs. (254 kg)	558 lbs. (253 kg)
Gross Vehicle Weight Rating (GVWR)	988 lbs. (449 kg)	988 lbs. (449 kg)
Gross Axle Weight Rating (GAWR)	Front 337 lbs. (153 kg) Rear 651 lbs. (296 kg)	Front 337 lbs. (153 kg) Rear 651 lbs. (296 kg)
Maximum Load Capacity (riders, cargo, accessories)	428 lbs. (194 kg)	430 lbs. (195 kg)
Capacities		
Engine Oil	3-4 qts. (2.8-3.8 L) with filter at oil change 4.5 qts. (4.25 L) total for new/rebuilt dry engine	
Fuel	3.3 gal. (12.5 L)	
Fuel Reserve (fuel light on)	.5 gal. (1.9 L)	
Fork Oil	20.3 oz. (599 cc)	
Radiator Coolant	2.75 qts. (2.6 L)	

SPECIFICATIONS

2017	INDIAN SCOUT	INDIAN SCOUT SIXTY
Engine		
Engine Type	Liquid Cooled V-Twin (60 degrees)	Liquid Cooled V-Twin (60 degrees)
Displacement	69 cu. in. (1133 cc)	61 cu. in. (999 cc)
Compression Ratio	10.7:1	11.0:1
Valve Train	DOHC, 4 Valves Per Cylinder, Graded Tappets	DOHC, 4 Valves Per Cylinder, Graded Tappets
Bore and Stroke	3.898" x 2.898" (99 mm x 73.6 mm)	3.661" x 2.898" (93 mm x 73.6 mm)
Fuel System/Throttle Body Bore	Closed Loop Fuel Injection/60 mm	Closed Loop Fuel Injection/54 mm
Exhaust System	Split Dual Exhaust w/Crossover	Split Dual Exhaust w/Crossover
Rev Limit	8300 RPM	8300 RPM
Idle RPM	1100 +/- 50 RPM Fully Warm	1100 +/- 50 RPM Fully Warm
Lubrication System	Semi-Dry Sump	Semi-Dry Sump
Spark Plug/Gap	NGK MR7F/.030 inch (0.80 mm)	NGK MR7F/.030 inch (0.80 mm)
Chassis		
Front Suspension Type/Travel	Telescopic Fork/4.7 in. (120 mm)	
Front Fork Tube Diameter	41 mm	
Rear Suspension Type/Travel	Dual Shocks/3 in. (76 mm)	
Swingarm	Steel	
Front Brakes	Single/298 mm Rotor/2-Piston Caliper	
Rear Brakes	Single/298 mm Rotor/1-Piston Caliper	

SPECIFICATIONS

2017	INDIAN SCOUT	INDIAN SCOUT SIXTY
Drive System		
Primary Drive	Gear Drive wet Clutch	Gear Drive Wet Clutch
Crank Gear	46 Teeth	46 Teeth
Clutch Gear	77 Teeth	77 Teeth
Clutch Type	Wet, Multi-Plate	Wet, Multi-Plate
Primary Reduction Ratio	1:674:1	1:674:1
Transmission Type	6 Speed/Sliding Mesh/Foot Shift	5 Speed/Sliding Mesh/Foot Shift
1st Gear Ratio	2.769:1	2.769:1
2nd Gear Ratio	1.882:1	1.882:1
3rd Gear Ratio	1.500:1	1.500:1
4th Gear Ratio	1.273:1	1.273:1
5th Gear Ratio	1.125:1	1.036:1
6th Gear Ratio	1.036:1	N/A
Gear Shift Pattern	1 Down/5 Up	1 Down/4 Up
Final Drive Type	Belt Drive, 141-Tooth	Belt Drive, 141-Tooth
Transmission	28-Tooth	28-Tooth
Rear Wheel	66-Tooth	66-Tooth
Ratio	2.357:1	2.357:1

SPECIFICATIONS

2017	INDIAN SCOUT	INDIAN SCOUT SIXTY
Drive System Continued		
Overall Gear Ratio		
1st Gear	10.925:1	10.925:1
2nd Gear	7.426:1	7.426:1
3rd Gear	5.918:1	5.918:1
4th Gear	5.023:1	5.023:1
5th Gear	4.439:1	4.088:1
6th Gear	4.088:1	N/A

SPECIFICATIONS

2017	INDIAN SCOUT / INDIAN SCOUT SIXTY
Wheels And Tires	
Front Wheel Size/Type	16 in. x 3.5 in. Cast
Rear Wheel Size/Type	16 in. x 3.5 in. Cast
Front Tire Type/Size	Kenda K673F 130/90-16 72H
Rear Tire Type/Size	Kenda K673 150/80-16 71H
Electrical	
Alternator	460W @ 3000 RPM
Battery	12 volt, 12 amp/hour, 210 CCA (cold cranking amps), Maintenance Free AGM
Voltage Regulator	14.5 volts/32 amp
Lamps (all bulbs are 12 volt)	
Headlight	Osram HB2 12V 60/55W LL
Tail/Brake Light	Non-serviceable LED
Turn Signal	RY10W
License Plate	Non-Serviceable LED
Speedometer	Non-Serviceable LED
Indicator Lights	Non-Serviceable LED
Position Bulb	W5W

SPECIFICATIONS

FUEL RECOMMENDATION

For best performance, use only unleaded gasoline with a 91 pump octane minimum (R+M/2 Method). **DO NOT USE E-85 GASOLINE OR GASOLINE CONTAINING METHANOL.** Using E85 or gasoline/methanol blends can result in poor starting and driveability, engine damage and damage to critical fuel system components.

- Gasoline containing up to 15% Ethanol can be used.
- Gasoline containing up to 15% Methyl Tertiary Butyl Ether (MTBE) can be used.

In the event that the recommended premium unleaded gasoline is not available and low octane fuel must be used, fill the fuel tank only partially with unleaded regular gasoline, then fill the tank fully with premium unleaded gasoline as soon as possible.

ENGINE OIL RECOMMENDATION

We recommend the use of INDIAN MOTORCYCLE Synthetic Blend 15W-60 Engine Oil for your motorcycle. This oil is formulated with synthetic-based oil and premium engine additive which have physical properties that meet API SM and ILSAC GF-4 specifications.

Do not blend oil additives with engine oil.

If oil must be added in an emergency and the recommended oil is not available, choose only a high-quality 15W-60 motorcycle oil. Change back to the recommended oil at the first opportunity.

NOTICE: Use of non-recommended lubricants can result in engine damage. Damage resulting from the use of non-recommended lubricants is not covered by warranty.

FORK OIL

We recommend the use of INDIAN MOTORCYCLE Fork Oil for your motorcycle.

BRAKE FLUID

We recommend the use of INDIAN MOTORCYCLE DOT 4 Brake Fluid for both brake master cylinders. *DO NOT use DOT 5 silicone fluid.*

WARRANTY

INDIAN MOTORCYCLE WARRANTY POLICY

LIMITED WARRANTY

Indian Motorcycle Company, 2100 Highway 55, Medina, MN 55340 (INDIAN MOTORCYCLE) gives a TWO YEAR LIMITED WARRANTY on all components of your INDIAN motorcycle against defects in material or workmanship. This warranty covers parts and labor charges for repair or replacement of defective parts and begins on the date of purchase by the original retail purchaser. This warranty is transferable to another owner during the warranty period through an INDIAN MOTORCYCLE dealer, but any such transfer will not extend the original term of the warranty. The duration of this warranty may vary by international region based upon local laws and regulations.

REGISTRATION

At the time of sale, the Warranty Registration Form must be completed by your dealer and submitted to INDIAN MOTORCYCLE within ten days of purchase. Upon receipt of this registration, INDIAN MOTORCYCLE will record the registration for warranty. No verification of registration will be sent to the purchaser as the copy of the Warranty Registration Form will be your proof of warranty coverage. If you have not signed the original registration and received the customer copy, please contact your dealer immediately. **NO WARRANTY COVERAGE WILL BE ALLOWED UNLESS YOUR MOTORCYCLE IS REGISTERED WITH INDIAN MOTORCYCLE.** Initial dealer preparation and set-up of your motorcycle is very important in ensuring trouble-free operation. Purchasing a vehicle in the crate or without proper dealer set-up will void your warranty coverage.

WARRANTY

WARRANTY COVERAGE AND EXCLUSIONS: LIMITATIONS OF WARRANTIES AND REMEDIES

This INDIAN MOTORCYCLE limited warranty excludes any failures that are not caused by a defect in material or workmanship. THIS WARRANTY DOES NOT COVER CLAIMS OF DEFECTIVE DESIGN. This warranty also does not cover acts of God, accidental damage, normal wear and tear, abuse or improper handling. This warranty also does not cover any motorcycle, component, or part that has been altered structurally, modified, neglected, improperly maintained, or used for purposes other than for which it was designed.

This warranty excludes damages or failures resulting from: improper lubrication; improper engine timing; improper fuel; surface imperfections caused by external stress, heat, cold or contamination; operator error or abuse; improper component alignment, tension, adjustment or altitude compensation; snow, water, dirt or other foreign substance ingestion/contamination; improper maintenance; modified components; use of aftermarket or unapproved components, accessories, or attachments; unauthorized repairs; or repairs made after the warranty period expires or by an unauthorized repair center.

This warranty excludes damages or failures caused by abuse, accident, fire, or any other cause other than a defect in materials or workmanship and provides no coverage for consumable components, general wear items, or any parts exposed to friction surfaces, stresses, environmental conditions and/or contamination for which they were not designed or not intended, including but not limited to the following items:

- Wheels and tires
- Suspension components
- Brake components
- Seat components
- Clutches and components
- Steering components
- Batteries
- Light bulbs/Sealed beam lamps
- Filters
- Lubricants
- Bushings
- Sealants
- Coolants
- Bearings
- Finished and unfinished surfaces
- Fuel Injectors/Throttle body components
- Engine components
- Drive belts
- Hydraulic components and fluids
- Circuit breakers/Fuses
- Electronic components
- Spark plugs

LUBRICANTS AND FLUIDS

1. Mixing oil brands or using non-recommended oil may cause engine damage. We recommend the use of INDIAN MOTORCYCLE engine oil.
2. Damage or failure resulting from the use of non-recommended lubricants or fluids is not covered by this warranty.

This warranty provides no coverage for personal loss or expense, including mileage, transportation costs, hotels, meals, shipping or handling fees, motorcycle pick-up or delivery, replacement rentals, loss of vehicle use, loss of profits, or loss of vacation or personal time.

THE EXCLUSIVE REMEDY FOR BREACH OF THIS WARRANTY SHALL BE, AT INDIAN MOTORCYCLE'S OPTION, REPAIR OR REPLACEMENT OF ANY DEFECTIVE MATERIALS, COMPONENTS, OR PRODUCTS. THE REMEDIES SET FORTH IN THIS WARRANTY ARE THE ONLY REMEDIES AVAILABLE TO ANY PERSON FOR BREACH OF THIS WARRANTY. INDIAN MOTORCYCLE SHALL HAVE NO LIABILITY TO ANY PERSON FOR INCIDENTAL, CONSEQUENTIAL OR SPECIAL DAMAGES OF ANY DESCRIPTION, WHETHER ARISING OUT OF EXPRESS OR IMPLIED WARRANTY OR ANY OTHER CONTRACT, NEGLIGENCE, OR OTHER TORT OR OTHERWISE. THIS EXCLUSION OF CONSEQUENTIAL, INCIDENTAL, AND SPECIAL DAMAGES IS INDEPENDENT FROM AND SHALL SURVIVE ANY FINDING THAT THE EXCLUSIVE REMEDY FAILED OF ITS ESSENTIAL PURPOSE.

THE IMPLIED WARRANTY OF FITNESS FOR A PARTICULAR PURPOSE IS EXCLUDED FROM THIS LIMITED WARRANTY. ALL OTHER IMPLIED WARRANTIES (INCLUDING BUT NOT LIMITED TO THE IMPLIED WARRANTY OF MERCHANTABILITY) ARE LIMITED IN DURATION TO THE ABOVE 12 MONTH WARRANTY PERIOD. INDIAN MOTORCYCLE DISCLAIMS ALL EXPRESS WARRANTIES NOT STATED IN THIS WARRANTY. SOME STATES DO NOT PERMIT THE EXCLUSION OR LIMITATION OF INCIDENTAL OR CONSEQUENTIAL DAMAGES OR ALLOW LIMITATIONS ON THE DURATION OF IMPLIED WARRANTIES, SO THE ABOVE LIMITATIONS MAY NOT APPLY TO YOU IF INCONSISTENT WITH CONTROLLING STATE LAW.

WARRANTY

HOW TO OBTAIN WARRANTY SERVICE

If your motorcycle requires warranty service, you must take it to an INDIAN MOTORCYCLE Servicing Dealer. When requesting warranty service you must present your copy of the Warranty Registration Form to the dealer. (THE COST OF TRANSPORTATION TO AND FROM THE DEALER IS YOUR RESPONSIBILITY). INDIAN MOTORCYCLE suggests that you use your original selling dealer; however, you may use any INDIAN MOTORCYCLE Servicing Dealer to perform warranty service.

IN THE COUNTRY WHERE YOUR MOTORCYCLE WAS PURCHASED:

Warranty or Service Bulletin repairs must be done by an authorized INDIAN MOTORCYCLE dealer. If you move or are traveling within the country where your motorcycle was purchased, Warranty and Service Bulletin repairs may be requested from any authorized INDIAN MOTORCYCLE dealer.

OUTSIDE THE COUNTRY WHERE YOUR MOTORCYCLE WAS PURCHASED:

If you are traveling temporarily outside the country where your motorcycle was purchased, you should take your motorcycle to an authorized INDIAN MOTORCYCLE dealer. You must show the dealer photo identification from the country of the selling dealer's authorized location as proof of residence. Upon residence verification, the servicing dealer will be authorized to perform the warranty repair.

IF YOU MOVE:

If you move to another country, be sure to contact INDIAN MOTORCYCLE Customer Assistance and the customs department of the destination country before you move. Vehicle importation rules vary considerably from country to country. You may be required to present documentation of your move to INDIAN MOTORCYCLE in order to continue your warranty coverage. You may also be required to obtain documentation from INDIAN MOTORCYCLE in order to register your motorcycle in your new country. You should warranty register your motorcycle at a local INDIAN MOTORCYCLE dealer in your new country immediately after you move to continue your warranty coverage and to ensure that you receive information and notices regarding your motorcycle.

IF YOU PURCHASE FROM A PRIVATE PARTY:

If you purchase an INDIAN motorcycle from a private party, to be kept and used outside of the country in which the motorcycle was originally purchased, all warranty coverage will be denied. You must nonetheless register your motorcycle under your name and address with a local INDIAN MOTORCYCLE dealer in your country to ensure that you receive safety information and notices regarding your motorcycle.

EXPORTED VEHICLES

EXCEPT WHERE SPECIFICALLY REQUIRED BY LAW, THERE IS NO WARRANTY OR SERVICE BULLETIN COVERAGE ON THIS VEHICLE IF IT IS SOLD OUTSIDE THE COUNTRY OF THE SELLING DEALER'S AUTHORIZED LOCATION. This policy does not apply to vehicles that have received authorization for export from INDIAN MOTORCYCLE. Dealers may not give authorization for export. You should consult an authorized dealer to determine this vehicle's warranty or service coverage if you have any questions. This policy does not apply to vehicles registered to government officials or military personnel on assignment outside the country of the selling dealer's authorized location. This policy does not apply to Safety Bulletins.

NOTICE

If your vehicle is registered outside of the country where it was purchased and you have not followed the procedure set above, your vehicle will no longer be eligible for warranty or service bulletin coverage of any kind, other than safety bulletins. Vehicles registered to Government officials or military personnel on assignment outside of the country where the vehicle was purchased will continue to be covered by the Limited Warranty.

Please work with your dealer to resolve any warranty issues. Should your dealer require any additional assistance, they will contact the appropriate person at INDIAN MOTORCYCLE.

This warranty gives you specific legal rights, and you may also have other rights which vary from state to state or in different countries. If any of the above terms are void because of federal, state, local law, all other warranty terms will remain in effect.

For questions call INDIAN MOTORCYCLE Customer Assistance:

United States & Canada: 1-877-204-3697

French: 1-800-268-6334

WARRANTY

MOTORCYCLE NOISE REGULATION

Tampering with noise control systems is prohibited. Federal law prohibits the following acts or causing thereof:

- The removal or rendering inoperative by any person other than for the purposes of maintenance, repair, or replacement, of any device or element of design incorporated into any new vehicle for the purpose of noise control prior to its sale or delivery to the ultimate purchaser or while it is in use, or
- The use of the vehicle after such device or element of design has been removed or rendered inoperative by any person.

Among those acts presumed to constitute tampering are:

- Removal or puncturing of the muffler, baffles, header pipes, or any other component which conducts exhaust gasses.
- Removal or puncturing of any part of the intake system.
- Lack of proper maintenance.
- Replacing any moving part of the vehicle, or parts of the exhaust system or intake system, with parts other than those specified by the manufacturer.

This product should be checked for repair or replacement if the motorcycle noise has increased significantly through use. Otherwise, the owner may become subject to penalties under state and local ordinances.

NOISE EMISSION WARRANTY

INDIAN MOTORCYCLE warrants that this exhaust system, at the time of sale, meets all applicable U.S. EPA Federal noise standards. This warranty extends to the first person who buys this exhaust system for purposes other than resale, and to all subsequent buyers.

Warranty claims should be directed to:

- An authorized INDIAN MOTORCYCLE dealer, or
- INDIAN MOTORCYCLE COMPANY, P.O. Box 47700, Medina, MN 55340-9960

EMISSIONS CONTROL SYSTEM WARRANTY

INDIAN MOTORCYCLE COMPANY - EMISSION CONTROL SYSTEM WARRANTY STATEMENT

YOUR WARRANTY RIGHTS AND OBLIGATIONS

The California Air Resources Board and INDIAN MOTORCYCLE COMPANY (hereinafter INDIAN MOTORCYCLE) are pleased to explain the emission control system warranty on your 2014 or later INDIAN motorcycle. In California, new motor vehicles must be designed, built and equipped to meet the state's stringent anti-smog standards. INDIAN MOTORCYCLE must warrant the emission control system on your motorcycle for the periods of time listed below provided there has been no abuse, neglect or improper maintenance of your motorcycle. Your emission control system may include parts such as the fuel-injection system, the ignition system, catalytic converter and engine computer. Also included may be hoses, belts, connectors and other emission related assemblies. Where a warrantable condition exists, INDIAN MOTORCYCLE will repair your motorcycle at no cost to you, including diagnosis, parts and labor.

MANUFACTURER'S WARRANTY COVERAGE

Class III motorcycles (280cc and larger): for a period of use of five (5) years or 30,000 kilometers (18,641 miles), whichever first occurs.

If an emission-related part on your motorcycle is defective, the part will be repaired or replaced by INDIAN MOTORCYCLE. This is your emission control system DEFECTS WARRANTY.

WARRANTY

OWNER'S WARRANTY RESPONSIBILITIES

As the motorcycle owner, you are responsible for the performance of the required maintenance listed in your Rider's manual. INDIAN MOTORCYCLE recommends that you retain all receipts covering maintenance on your motorcycle, but INDIAN MOTORCYCLE cannot deny warranty solely for the lack of receipts or for your failure to ensure the performance of all scheduled maintenance. You are responsible for presenting your motorcycle to an INDIAN MOTORCYCLE dealer as soon as a problem exists. The warranty repairs should be completed in a reasonable amount of time, not to exceed 30 days. As the motorcycle owner, you should be aware that INDIAN MOTORCYCLE may deny your warranty coverage if your motorcycle or part has failed due to abuse, neglect, improper maintenance or unapproved modifications.

If you have any questions regarding your warranty rights and responsibilities, you should contact INDIAN MOTORCYCLE COMPANY, P.O. Box 47700, Medina, Minnesota 55340-9960, or the California Air Resources Board, P.O. Box 8001, 9528 Telstar Avenue, El Monte, CA 91734-8001.

INDIAN MOTORCYCLE COMPANY, (hereinafter INDIAN MOTORCYCLE) warrants that each new 2014 and later INDIAN motorcycle that includes as standard equipment a headlight, taillight and stoplight, and is street legal:

- A. is designed, built and equipped so as to conform at the time of initial retail purchases with all applicable regulations of the United States Environmental Protection Agency, and the California Air Resources Board; and
- B. is free from defects in material and workmanship which cause such motorcycle to fail to conform with applicable regulations of the United States Environmental Protection Agency or the California Air Resources Board for a period of use, depending on the engine displacement, of 12,000 kilometers (7,456 miles), if the motorcycle's engine displacement is less than 170 cubic centimeters; of 18,000 kilometers (11,185 miles), if the motorcycle's engine displacement is equal or greater than 170 cubic centimeters but less than 280 cubic centimeters; or of 30,000 kilometers (18,641 miles), if the motorcycle's engine displacement is 280 cubic centimeters or greater; or 5 (five) years from the date of initial retail delivery, whichever occurs first.

I. COVERAGE

Warranty defects shall be remedied during customary business hours at any authorized INDIAN MOTORCYCLE dealer located within the United States of America in compliance with the Clean Air Act and applicable regulations of the United States Environmental Protection Agency and the California Air Resources Board. Any part or parts replaced under this warranty shall become the property of INDIAN MOTORCYCLE.

In the State of California only, emission-related warranted parts are specifically defined by the state's Emission Warranty Parts List. These warranted parts are: carburetor and internal parts; intake manifold; fuel tank; fuel injection system; spark advance mechanism; crankcase breather; air cutoff valves; fuel tank cap for evaporative emission controlled vehicles; oil filler cap; pressure control valve; fuel/vapor separator; canister; igniters; breaker governors; ignition coils; ignition wires; ignition points; condensers, and spark plugs if failure occurs prior to the first scheduled replacement; and hoses, clamps, fittings and tubing used directly in these parts. Since emission related parts may vary from model to model, certain models may not contain all of these parts and certain models may contain functionally equivalent parts. In the State of California only, Emission Control System emergency repairs, as provided for in the California Administrative Code, may be performed by other than an authorized INDIAN MOTORCYCLE dealer. An emergency situation occurs when an authorized INDIAN MOTORCYCLE dealer is not reasonably available, a part is not available within 30 days or a repair is not complete within 30 days. Any replacement part can be used in an emergency repair. INDIAN MOTORCYCLE will reimburse the owner for expenses, including diagnosis, not to exceed INDIAN MOTORCYCLE's suggested retail price for all warranted parts replaced and labor charges based on INDIAN MOTORCYCLE'S recommended time allowance for the warranty repair and the geographically appropriate hourly labor rate. The owner may be required to keep receipts and failed parts in order to receive compensation.

WARRANTY

II. LIMITATIONS

The Emission Control System Warranty shall not cover any of the following:

A. Repair or replacement required as a result of:

- Accident
- Misuse
- Repairs improperly performed or replacements improperly installed
- Use of replacement parts or accessories not conforming to INDIAN MOTORCYCLE specifications which adversely affect performance and/or
- Use in competitive racing or related events.

B. Inspections, replacement of parts, and other services and adjustments necessary for required maintenance

C. Any motorcycle on which the odometer mileage has been changed so that actual mileage cannot be readily determined.

III. LIMITED LIABILITY

- A. The liability of INDIAN MOTORCYCLE under this Emission Control System Warranty is limited solely to the remedying of defects in material or workmanship by an authorized INDIAN MOTORCYCLE dealer at its place of business during customary business hours. This warranty does not cover inconvenience or loss of use of the motorcycle or transportation of the motorcycle to or from the INDIAN MOTORCYCLE dealer. INDIAN MOTORCYCLE SHALL NOT BE LIABLE FOR ANY OTHER EXPENSES, LOSS OR DAMAGE, WHETHER DIRECT, INCIDENTAL, CONSEQUENTIAL OR EXEMPLARY ARISING IN CONNECTION WITH THE SALE OR USE OF OR INABILITY TO USE THE INDIAN MOTORCYCLE FOR ANY PURPOSE. SOME STATES DO NOT ALLOW THE EXCLUSION OR LIMITATION OF ANY INCIDENTAL OR CONSEQUENTIAL DAMAGES, SO THE ABOVE LIMITATIONS MAY NOT APPLY TO YOU.
- B. NO EXPRESS EMISSION CONTROL SYSTEM WARRANTY IS GIVEN BY INDIAN MOTORCYCLE EXCEPT AS SPECIFICALLY SET FORTH HEREIN. ANY EMISSION CONTROL SYSTEM WARRANTY IMPLIED BY LAW, INCLUDING ANY WARRANTY OF MERCHANTABILITY OR FITNESS FOR A PARTICULAR PURPOSE, IS LIMITED TO THE EXPRESS EMISSION CONTROL SYSTEM WARRANTY TERMS STATED IN THIS WARRANTY. THE FOREGOING STATEMENTS OF WARRANTY ARE EXCLUSIVE AND IN LIEU OF ALL OTHER REMEDIES. SOME STATES DO NOT ALLOW LIMITATIONS ON HOW LONG AN IMPLIED WARRANTY LASTS SO THE ABOVE LIMITATIONS MAY NOT APPLY TO YOU.
- C. No dealer is authorized to modify this INDIAN MOTORCYCLE Limited Emission Control System Warranty.

WARRANTY

IV. LEGAL RIGHTS

THIS WARRANTY GIVES YOU SPECIFIC LEGAL RIGHTS, AND YOU MAY ALSO HAVE OTHER RIGHTS WHICH VARY FROM STATE TO STATE.

V. THIS WARRANTY IS IN ADDITION TO THE INDIAN MOTORCYCLE LIMITED MOTORCYCLE WARRANTY

VI. ADDITIONAL INFORMATION

Any replacement part that is equivalent in performance and durability may be used in the performance of any maintenance or repairs. However, INDIAN MOTORCYCLE is not liable for these parts. The owner is responsible for the performance of all required maintenance. Such maintenance may be performed at a service establishment or by any individual. The warranty period begins on the date the motorcycle is delivered to an ultimate purchaser.

INDIAN MOTORCYCLE COMPANY

P.O. Box 47700

Medina, MN 55340-9960

ATTN: Warranty Department

United States & Canada: 1-877-204-3697

French: 1-800-268-6334

MAINTENANCE LOG

MAINTENANCE PERFORMED	MILES/KM	NOTES	PERFORMED BY

A		Clutch Lever..... 37	Exhaust System Inspection101
About the Rider's Manual..... 9	Component Identification..... 21–22	Console..... 24	Exposure to Dirt/Dust110
Accelerating 62	Coolant Level Inspection..... 72	Cooling System 72	Exposure to Moisture..... 110
Air Filter..... 73	Crankcase Breather Hoses..... 83		Exposure to Sun110
Anti-Lock Brake System (ABS) (if equipped) 39			
Anti-Lock Brake System Inspection 91			
B			
Battery 98			
Battery Care.....114			
Battery Charging 99			
Battery Installation 98			
Battery Removal..... 98			
Brake Disc Inspection/Cleaning 90			
Brake Fluid122			
Brake Fluid Precautions..... 87			
Brake Hoses/Connections 87			
Brake Pads..... 90			
Braking 62			
Break-In Maintenance 66			
C			
Carrying a Passenger 13			
Clean and Protect the Motorcycle113			
Cleaning Products.....107			
Clock..... 34			
	D		
	Diagnostic Functionality 34		
	Display Units (Standard/Metric) 34		
	E		
	Electrical Precautions 101		
	Elevating the Motorcycle..... 101		
	Engine Break-In..... 53		
	Engine Coolant Temperature 33		
	Engine Error Codes..... 35		
	Engine Identification Number 23		
	Engine Oil Level 44		
	Engine Oil Recommendation 122		
	Engine Oil/Filter Change 70		
	Engine Protection..... 113		
	Engine Speed..... 33		
	Engine Starter Switch..... 28		
	Engine Stop/Run Switch 27		
	Evaporative Emission Control System (California Models)..... 84		
	F		
	Fastener Inspection102		
	Fastener Torques102		
	Fork Oil122		
	Front Brake Fluid..... 89		
	Front Brake Fluid Level 47		
	Front Brake Lever 40, 89		
	Front Fork/Suspension Inspection 82		
	Front Suspension, Inspection 50		
	Front Wheel Installation 92		
	Fuel and Exhaust Safety 17		
	Fuel Filter 73		
	Fuel Level 50		
	Fuel Recommendation 122		
	Fuel Stabilizer 113		
	Fuel System Components 84		
	Fuel Tank Installation..... 76		
	Fuel Tank Removal 74		
	Fueling..... 55		
	Fuse Replacement..... 99		
	G		
	Gear Indicator 33		

INDEX

Gear Shift Lever 38
Gloss Clear Coat Finish Care 109
Gross Vehicle Weight Rating 19
GVWR..... 19

H

Hazard Warning Flashers Switch 27
Headlight Aim Adjustment 96
Headlight Aim Inspection 96
Headlight Lamp Replacement 97
High/Low Headlight Beam Switch 28

I

Identification Number Record 7
Ignition/Light Key Switch 29
Indicator Lamps 31
Information Labels 20
Instrument Cluster 30

K

Key Identification Number 23

L

Leather Care 110

Leather Care Dressing 111

M

Maintenance During Storage 114
Maintenance Log 135
Maintenance, Major 66
Matte Clear Coat Finish Care 108
Mechanical Clutch Cable Lubrication ... 86
Mechanical Clutch Lever Freeplay 85
Mechanical Clutch Lever Lubrication ... 86
Mechanical Clutch, Inspection 49
MFD Indicators 32
Mirrors 37
Misfire Detection 58
Mode Button 27
Modifications 15
Multi-Function Display (MFD) 33

O

Odometer 33
Operating Speeds and Gears 54
Over Temperature Display and
Warning Indicator 36

P

Park and Cover the Motorcycle 114

Parking 63
Parking on a Slope 63
Parking on a Soft Surface 63
Parking the Motorcycle 15
Periodic Maintenance 66
 Severe Use Definition 66
Periodic Maintenance Table 67
Pre-Ride Inspections 41
 Brake Lines 49
 Fasteners 51
 Front Brake Lever, Inspection 48
 Rear Brake Pedal, Inspection 48
 Throttle 50
 Tire Condition 46
 Tires 46, 93
Priming the Fuel System 56
Protective Apparel 14

R

Rear Brake Fluid 88
Rear Brake Fluid Level 48
Rear Brake Pedal 40, 87
Rear Drive Belt Cleaning 78
Rear Drive Belt Condition 78
Rear Drive Belt Wear Analysis 79
Rear Drive Belt, Inspection 50
Rear Shock Preload (Ride Height)
 Adjustment 81
Rear Shock Preload Inspection 80
Rear Suspension, Inspection 50

REGISTRATION.....123
 Removal From Storage115
 Reporting Safety Defects 19
 Road Test.....102
 Road Tests 66
 Rodents114

S

Saddlebags 15
 Safe Riding Practices 10
 Safety During Service Procedures..... 65
 Safety Labels 20
 Safety Maintenance 18
 Safety Symbols and Signal Words 4
 Seat Removal/Installation 95
 Service Information 7
 Shift Point, Recommended 61
 Shifting Gears..... 59
 Shifting Gears While Stationary 59
 Sidestand..... 38
 Sidestand Lubrication 84
 Sidestand, Inspection 50
 Spark Plugs 95
 Specifications117
 Speedometer 30
 Starting the Engine 57
 Steering Head Inspection 83
 Stopping the Engine 62
 Storage Area Preparation112

Swing Arm/Rear Axle Inspection 82
 Switches 25

T

Throttle Control Grip 37
 Throttle Control Inspection 84
 Tire Condition 93
 Tire Inflation.....113
 Tire Pressure 46, 94
 Tire Replacement..... 93
 Tire Tread Depth..... 46, 93
 Tone Ring/Sensor Inspection 91
 Transporting the Motorcycle 17
 Trip Odometer 33
 Troubleshooting103

W

Warranty123
 Warranty Information..... 7
 Warranty, Emissions Control System129
 Washing the Motorcycle107
 Wheel Alignment 91
 Wheel Inspection 91
 Windshield Care (if equipped).....108



To locate your nearest dealer,
visit www.indianmotorcycle.com

Indian Motorcycle Company
2100 Highway 55
Medina, MN 55340
Phone: 1-877-204-3697
French: 1-800-268-6334

Part No. 9927436 Rev 02
Printed in USA

