

ACCESSORY CATALOG



2022

U.S.A.





2022

INTRO
2-11

FTR
12-27

SCOUT
28-51

INDIAN CHIEF
52-67

INDIAN SPRINGFIELD
68-91

CHIEFTAIN & ROADMASTER
92-121

INDIAN CHALLENGER
122-135

POWERBAND AUDIO
136-139

COLOR-MATCHED ACCESSORIES
140-143

GARAGE
144-151

eFTR
154-155

FTR	12
Style	16
Performance & Suspension	20
Wheels & Tires	21
Storage & Luggage	22
Protection	24
Comfort	26

SCOUT	28
Engine Performance	38
Storage & Luggage	39
Seats & Backrests	40
Protection	42
Handlebars & Controls	44
Lighting & Electrical	46
Wheels & Suspension	47
Crafted Style Pieces	48

INDIAN CHIEF	52
Engine Performance	58
Storage & Luggage	60
Seats & Backrests	60
Protection	62
Handlebars & Controls	64
Lighting & Electrical	66
Crafted Style Pieces	67

INDIAN SPRINGFIELD	68
Engine Performance	72
Storage & Luggage	76
Seats & Backrests	80
Protection	82
Handlebars & Controls	84
Lighting & Electrical	86
Wheels & Suspension	87
Crafted Style Pieces	88

CHIEFTAIN & ROADMASTER	92
Engine Performance	102
Storage & Luggage	106
Seats & Backrests	110
Protection	112
Handlebars & Controls	114
Lighting & Electrical	116
Wheels & Suspension	117
Crafted Style Pieces	118

INDIAN CHALLENGER	122
Engine Performance	126
Storage & Luggage	128
Seats & Backrests	130
Protection	131
Handlebars & Controls	132
Lighting & Electrical	134
Crafted Style Pieces	135

POWERBAND AUDIO 136

COLOR-MATCHED ACCESSORIES 140

GARAGE 144

eFTR 154

CLIMACOMMAND SEATS

BE IN COMMAND OF YOUR COMFORT



2022

INTRO
2-11

FTR
12-27

SCOUT
28-51

INDIAN CHIEF
52-67

INDIAN SPRINGFIELD
68-91

CHIEFTAIN &
ROADMASTER
92-121

INDIAN CHALLENGER
122-135

POWERBAND AUDIO
136-139

COLOR-MATCHED
ACCESSORIES
140-143

GARAGE
144-151

eFTR
154-155

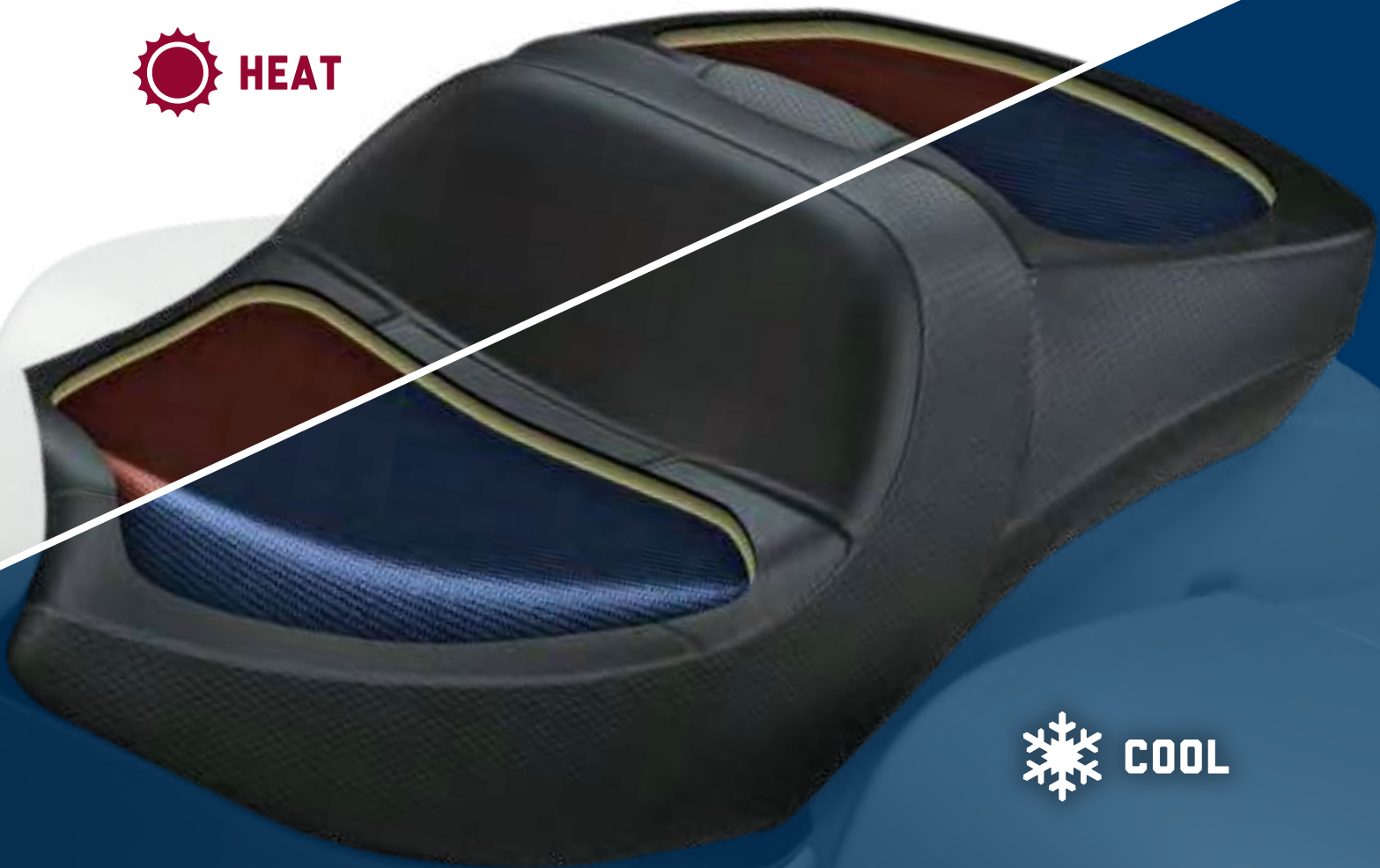

CLIMACOMMAND
COMFORT SEAT
Pg. 130



CLIMACOMMAND
ROGUE SEAT
Pg. 80, 110



CLIMACOMMAND
CLASSIC SEAT
Pg. 80, 110

Compatible with
RIDE COMMAND*

Compatible with
RIDE COMMAND*

*On 2020-2022 Chieftain models &
Roadmaster models with RIDE COMMAND.

The rider and passenger both enjoy a comfortable ride in all conditions with these innovative ClimaCommand Seats. These well-cushioned seats provide adjustable heating and cooling controls both on the side of the seat, as well as through the RIDE COMMAND display. Enjoy a heated seat when the weather turns cool, and experience a cooling, comfortable seat that minimizes sweating and discomfort during warm-weather riding. Thermoelectric technology to cool or heat the seat is combined with flexible Graphene material to help disperse that feeling to the most needed areas of the seat. These seats have a durable vinyl cover that is water-resistant and UV-resistant, easy to clean to maintain its showroom appearance. Passenger Armrest Pads and a Trunk Backrest Pad, both with coordinated styling, are also available (each sold separately).



ADDITIONAL SEATING OPTIONS



SLIM ROGUE
SEAT
Pg. 130



ROGUE SEAT
Pg. 80, 110



NEW
PREMIUM ROGUE
HEATED SEAT
Pg. 130



NEW
PREMIUM TOURING
SEAT
Pg. 130



EXTENDED REACH
ROGUE SEATS
Pg. 80, 110, 130



GENUINE LEATHER
TOURING HEATED SEAT
Pg. 80, 110



GENUINE LEATHER
EXTENDED REACH
HEATED SEAT
Pg. 80, 110



GENUINE LEATHER
REDUCED REACH
HEATED SEAT
Pg. 80, 110



GENUINE LEATHER
HEATED SEAT
Pg. 80, 110



NEW
EXTENDED REACH
SOLO SEAT
Pg. 60



NEW
REDUCED REACH
SEAT
Pg. 60



NEW
1920 SOLO RIDER
SADDLE SEAT
Pg. 60

PATHFINDER LIGHTING OPTIONS

ILLUMINATE THE ROAD AHEAD



2022

INTRO
2-11

FTR
12-27

SCOUT
28-51

INDIAN CHIEF
52-67

INDIAN SPRINGFIELD
68-91

CHIEFTAIN &
ROADMASTER
92-121

INDIAN CHALLENGER
122-135

POWERBAND AUDIO
136-139

COLOR-MATCHED
ACCESSORIES
140-143

GARAGE
144-151

eFTR
154-155



PATHFINDER 5 3/4 IN. ADAPTIVE LED HEADLIGHT



PATHFINDER ADAPTIVE LED HEADLIGHT
Pg. 86, 116

MONITORS LEAN ANGLE REAL-TIME TO DELIVER OPTIMIZED ILLUMINATION

15 INDIVIDUAL BEAMS ACTIVATE AS NEEDED

OPTIMIZED LIGHTING IN BOTH LOW-BEAM & HIGH-BEAM

REDUCES GLARE FROM ROAD AND DIRECTS LIGHT WHERE YOU NEED IT



PATHFINDER S LED DRIVING LIGHTS
Pg. 66, 116, 134

3.5-INCH DIAMETER

POWERFUL, FAR REACHING LED LIGHTING ELEMENTS

INCREASES VISIBILITY OF MOTORCYCLE

(See page 66, 116, 134 for Pathfinder S LED Driving Lights Mounts)

ADDITIONAL LIGHTING



PATHFINDER AUXILIARY LED SADDLEBAG LIGHTS



NEW
PATHFINDER AUXILIARY LED SADDLEBAG LIGHTS
Pg. 86, 116, 134



PATHFINDER LED HEADLIGHT
Pg. 86, 116



PATHFINDER LED DRIVING LIGHTS
Pg. 86, 116



NEW
SCOUT PATHFINDER 5 3/4 IN. ADAPTIVE LED HEADLIGHT
Pg. 46



SCOUT PATHFINDER LED HEADLIGHT
Pg. 46

PERFORMANCE LINEUP

POWER. CONTROL. PERFORMANCE.



2022

STAGE 1 RICH SOUND, MORE POWER

STAGE 2 AN INSTANT POWER BOOST

STAGE 3 OUT-PERFORM THE COMPETITION

SCOUT MODELS



STAGE 1 STRAIGHTS SLIP-ON EXHAUST KIT
2882012-266



STAGE 1 SHORTY SLIP-ON MUFFLER KIT
2884110-156/266



STAGE 1 2-INTO-1 FULL EXHAUST SYSTEM
2884111-156/266



PERFORMANCE AIR INTAKE
2882519

THUNDERSTROKE 111 MODELS

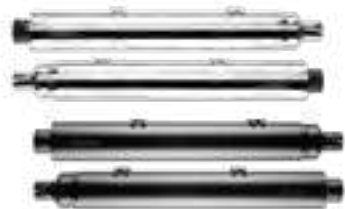

THUNDERSTROKE STAGE 1
SLIP-ON EXHAUST KIT
2879769-156/266 or
2879768-156/266



STAGE 1 OVAL SLIP-ON MUFFLER KIT
2884187-156/266



THUNDERSTROKE STAGE 1
PERFORMANCE AIR INTAKE
2881779-156/521



THUNDERSTROKE HIGH
FLOW AIR INTAKE
2880654-156/266



THUNDERSTROKE FORWARD
STAGE 1 AIR INTAKE
2884950-156/266



THUNDERSTROKE STAGE 2
PERFORMANCE CAMS
2881676



THUNDERSTROKE 116 CI STAGE 3 BIG BORE KIT
2021-2022 Indian Springfield 2885158
2021 Vintage Models 2884322 (shown)

THUNDERSTROKE 116 MODELS



THUNDERSTROKE STAGE 1
SLIP-ON EXHAUST KIT
2879769-156/266



STAGE 1 OVAL SLIP-ON MUFFLER KIT
2884187-156/266



THUNDERSTROKE STAGE 1
PERFORMANCE AIR INTAKE
2881779-156/521



THUNDERSTROKE HIGH
FLOW AIR INTAKE
2880654-156/266



THUNDERSTROKE FORWARD
STAGE 1 AIR INTAKE
2884950-156/266



THUNDERSTROKE STAGE 2
PERFORMANCE KIT
2884323

POWERPLUS MODELS



THUNDERSTROKE STAGE 1 SLIP-ON EXHAUST KIT
2879769-156/266



STAGE 1 OVAL SLIP-ON MUFFLER KIT
2884187-156/266



POWERPLUS STAGE 1 AIR INTAKE
2884461-266 (50 state) | 2883737-266 (49 state)



POWERPLUS STAGE 2 PERFORMANCE CAMS
2021-2022 2884573 (50 state)
2020-2022 2885178

INTRO
2-11

FTR
12-27

SCOUT
28-51

INDIAN CHIEF
52-67

INDIAN SPRINGFIELD
68-91

CHIEFTAIN &
ROADMASTER
92-121

INDIAN CHALLENGER
122-135

POWERBAND AUDIO
136-139

COLOR-MATCHED
ACCESSORIES
140-143

GARAGE
144-151

eFTR
154-155

See inside back cover for information on performance accessories .

POWERBAND AUDIO

TAKE A FRONT ROW SEAT



POWERBAND AUDIO SADDLEBAG SPEAKERS

THE LOUDEST AUDIO IN INDIAN MOTORCYCLE HISTORY

9 BAND EQUALIZER | PRE-TUNED SETTINGS | INTEGRATED WITH RIDE COMMAND



POWERBAND 5 1/4 IN. FAIRING & HARD LOWER SPEAKERS*



POWERBAND 6 1/2 IN. FAIRING SPEAKERS*



POWERBAND 6 1/2 IN. SADDLEBAG SPEAKERS*



POWERBAND 5 1/4 IN. TRUNK SPEAKERS*

CRAFTED TO FIT

FOR THUNDERSTROKE & SCOUT MODELS



REDUCED & EXTENDED REACH ACCESSORIES TO CREATE A BIKE CRAFTED TO FIT YOU.

REDUCED REACH

FOR RIDERS
5'6" & UNDER



STANDARD BIKES

FOR RIDERS
5'7" TO 6'0"



EXTENDED REACH

FOR RIDERS
6'1" & OVER

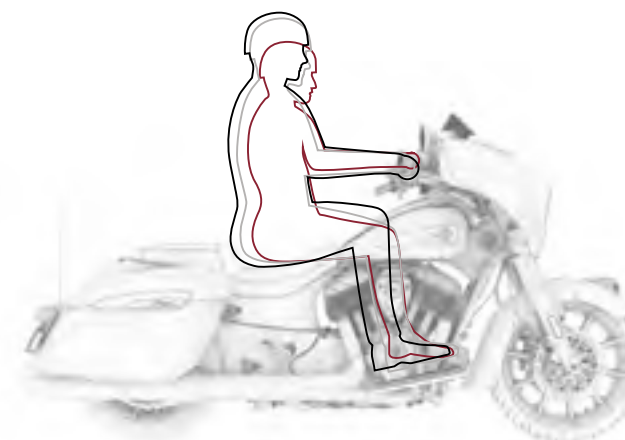
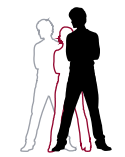

THUNDERSTROKE MODELS

SEATS: Pg. 60, 80, 110 & 130
HANDLEBARS: Pg. 64, 84, 114 & 132
FOOT CONTROLS*: Pg. 65

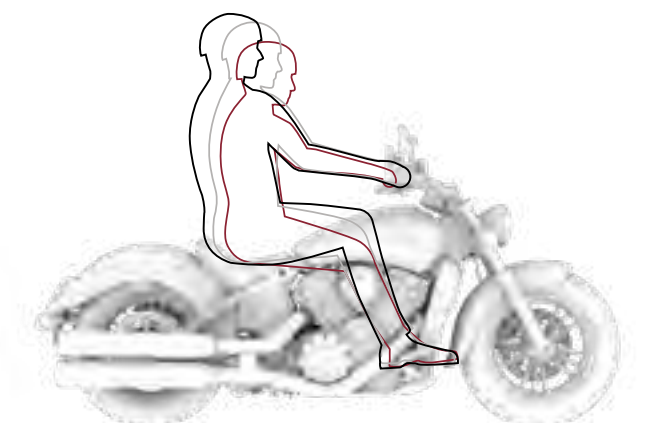

SCOUT MODELS

SEATS*: Pg. 40
HANDLEBARS: Pg. 44
FOOT CONTROLS*: Pg. 45



2022

INTRO
2-11

FTR
12-27

SCOUT
28-51

INDIAN CHIEF
52-67

INDIAN SPRINGFIELD
68-91

CHIEFTAIN & ROADMASTER
92-121

INDIAN CHALLENGER
122-135

POWERBAND AUDIO
136-139

COLOR-MATCHED ACCESSORIES
140-143

GARAGE
144-151

eFTR
154-155



ACCESSORIES FEATURED

1. High Mount Slip-On Exhaust by Akrapovič, Pg. 20
2. RAM® X-Grip® Phone Mount, Pg. 27
3. Side Bag, Pg. 23
4. Aviator Seat, Pg. 26

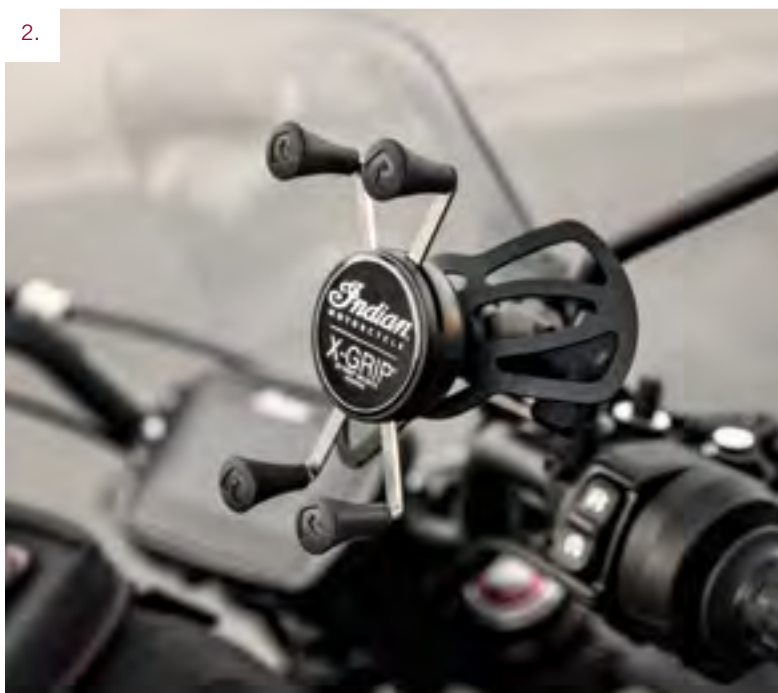
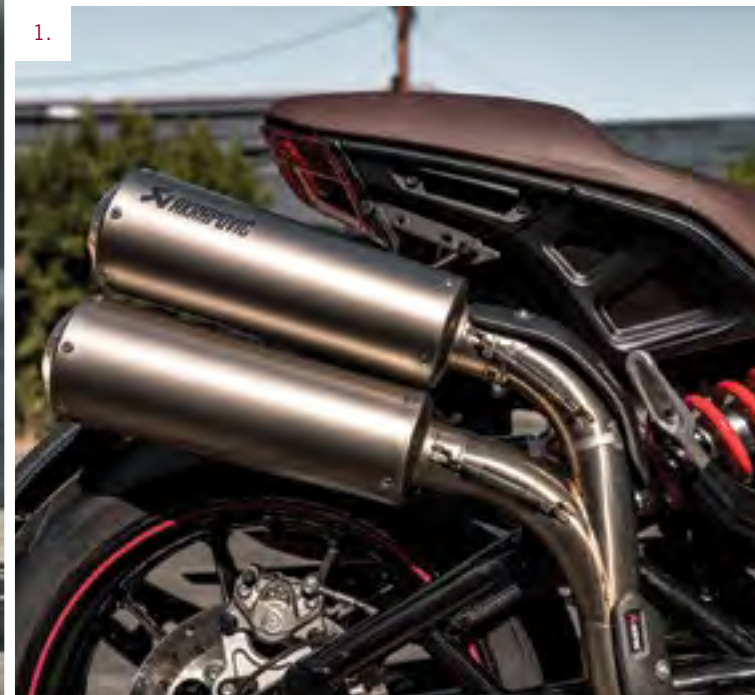

FTR R CARBON



ACCESSORIES FEATURED

1. Carbon Fiber Nacelle, Pg. 17
2. Carbon Fiber Tank Cover, Pg. 16
3. Carbon Fiber Chain Guard, Pg. 17
4. Carbon Fiber Radiator Guard, Pg. 17
5. Carbon Fiber Front Fender, Pg. 17
6. Carbon Fiber Seat Cowl, Pg. 17



FTR STYLE



CARBON FIBER TANK COVER



CARBON FIBER TANK COVER

Get that lightweight race-ready look with this carbon fiber tank cover featuring the iconic Indian Motorcycle script. The covers are made of high quality black 3K 2x2 twill weave carbon fiber and are sure to add strength and style to your ride. Includes left and right side.

2884089 \$599.99

Fits 2019-2022 FTR models.



TANK COVERS

What appears to be the FTR 1200 fuel tank is actually the bike's air box; the fuel tank sits below the seat. The air box has removable side panels, which means you can customize your bike with alternative panels, done up in various paint and decal schemes. Includes left and right side.

2884143	Unpainted	\$99.99
2884143-1831	Matte Blue Fire	\$499.99
2884143-1807	Gloss Pearl White	\$499.99
2884143-1545	Black	\$499.99
2884143-1646	Red	\$499.99

Fits 2019-2022 FTR models.



SIDE NUMBER PLATES

Make your FTR 1200 look like it's at home on the track with the flat-track-style Side Number Plates, which come with customizable black decal kits that let you choose any number 00-99. The injection-molded plastic plates come with black powder-coated mounting kits.

2883505 \$249.99

Fits 2019-2022 FTR models.



CARBON FIBER SEAT COWL

Get lighter to go faster with the premium black Carbon Fiber Seat Cowl. Kit includes mounting brackets, foam and installation hardware. Not compatible with the Aviator or Tracker seat.

2883900 \$399.99

Fits 2019-2022 FTR models.



CARBON FIBER FRONT FENDER

Infuse your bike with the ultimate in custom bodywork: a genuine Carbon Fiber Front Fender. It is made of premium black 3K 2x2 twill-weave carbon fiber. This fender is lightweight, strong, durable, and it features the inimitable look of true carbon fiber. It replaces the standard fender.

2884088	19 In. Front Wheel*	\$299.99
2884463	17 In. Front Wheel**	\$279.99

*Fits 2019-2020 FTR models & 2022 FTR Rally.

**Fits 2022 FTR models except FTR Rally.



NEW

AERO MANAGEMENT KIT

This Aero Management Kit enhances FTR styling and improves airflow for the rider. This kit includes restyled radiator guards, radiator louvers, a new front cylinder deflector and required hardware. Dealer installation recommended.

2889571 \$129.99

Fits 2019-2020 FTR models.

Stock on 2022 models.



CARBON FIBER NACELLE®

2884673	With Headlight Cowl* (shown)	\$349.99
2884812	Without Headlight Cowl**	\$379.99

*Fits 2019-2020 FTR1200 S.

**Fits 2019-2022 FTR1200 & FTR Rally & 2022 FTR1200 S. Stock on FTR Carbon.



CARBON FIBER CHAIN GUARD

Elevate your bike's custom style with this Carbon Fiber Chain Guard. This genuine carbon fiber guard installs in place of the standard chain guard, and it features unique, distinctive spread tow weave in select areas for an optimized custom look.

2884464 \$209.99

Fits 2019-2022 FTR models.



CARBON FIBER RADIATOR GUARDS

Add to your bike's distinctive custom style with these Carbon Fiber Radiator Guards. They feature a design identical to that of the standard guards, but they are made of 100% genuine carbon fiber.

2884466 \$279.99

Fits 2019-2022 FTR models.



CARBON FIBER V-COVERS

Add to your bike's distinctive custom style with this set of Carbon Fiber V-Covers. They feature a design identical to that of the standard covers, but they are made of 100% genuine carbon fiber.

2884465 \$269.99

Fits 2019-2022 FTR models.



2022

INTRO
2-11

FTR
12-27

SCOUT
28-51

INDIAN CHIEF
52-67

INDIAN SPRINGFIELD
68-91

CHIEFTAIN &
ROADMASTER
92-121

INDIAN CHALLENGER
122-135

POWERBAND AUDIO
136-139

COLOR-MATCHED
ACCESSORIES
140-143

GARAGE
144-151

eFTR
154-155

FTR STYLE



HIGH LICENSE PLATE MOUNT

Relocate your license plate underneath the seat with this High License Plate Mount that gives your FTR clean and sporty style. This kit contains everything you need to mount the stock plate holder in an underseat location, and it also includes cast aluminum hand-holds on which to mount the rear turn signals. Accessory Mounting Kit (2883842) sold separately, required.

2884060-385	Cloud Silver*	\$329.99
2884060	Matte Black	\$279.99

Fits 2019-2022 FTR models.

*Specifically made to match 2022 FTR R Carbon.



TRACKER SEAT BASE COWL

A flat-track bike's snub-nose rear cowl is one of its most distinctive, attractive features, which is why it's been embraced by builders and enthusiasts outside of the race paddock. This injection-molded cowl for your FTR 1200 is available in three colors.

2884145-266	Thunder Black	\$299.99
2884145-639	Indian Motorcycle Red	\$299.99
2884145-666	Thunder Black Pearl	\$299.99

Fits 2019-2022 FTR models.



CLEAR TURN SIGNALS

These four turn signals function as stock, but use clear lenses instead of amber.

2884156	\$119.99
---------	----------

Fits 2019-2022 FTR models.



REAR MUDGUARD

No rally machine would be complete without the proper mudguard to look the part. As a compliment to the front, the Rear Mudguard keeps the tail looking mean and your tail looking clean. The Rear Mudguard is made of injection-molded plastic and is painted Silver Smoke to complement the Front Mudguard. Accessory Mounting Kit (2883842) required, sold separately.

2883502-581	\$199.99
-------------	----------

Fits 2019-2022 FTR models.



FRONT MUDGUARD

Channel your inner desert racer with the rally-style Front Mudguard. The Silver Smoke plastic stock replacement mudguard mounts up with black powder-coated tubular fork guards and is as adventure-ready as you are. Complete the look with the matching Rear Mudguard, sold separately.

2883501-581	\$299.99
-------------	----------

Fits 2019-2020 FTR models & 2022 FTR Rally.



BRAKE AND SHIFT LEVERS BY ROLAND SANDS DESIGN®

2884091	Black	\$229.99
---------	-------	----------

Fits 2019-2020 FTR models & 2022 FTR Rally.



ENGINE COVER BY ROLAND SANDS DESIGN®

2884093	Black	\$99.99
---------	-------	---------

Fits 2019-2022 FTR models.



BRAKE FLUID RESERVOIR COVERS BY ROLAND SANDS DESIGN®

2884097	Black	\$119.99
---------	-------	----------

Fits 2019-2022 FTR models.



RADIAL RS MIRRORS BY RIZOMA®

Includes all necessary mounting hardware.

2883771	\$369.99
---------	----------

Fits 2019-2022 FTR models.



SWING ARM SPOOLS BY ROLAND SANDS DESIGN®

2884099	Black	\$69.99
---------	-------	---------

Fits 2019-2022 FTR models.



COMFORT HANDLEBAR GRIPS BY ROLAND SANDS DESIGN®

2884094	Black	\$49.99
---------	-------	---------

Fits 2019-2022 FTR models.



HANDGUARDS BY ROLAND SANDS DESIGN®

2884095	Black	\$179.99
---------	-------	----------

Fits 2019-2022 FTR models.

RADIAL RS MIRRORS BY RIZOMA®



2022

INTRO
2-11

FTR
12-27

SCOUT
28-51

INDIAN CHIEF
52-67

INDIAN SPRINGFIELD
68-91

CHIEFTAIN &
ROADMASTER
92-121

INDIAN CHALLENGER
122-135

POWERBAND AUDIO
136-139

COLOR-MATCHED
ACCESSORIES
140-143

GARAGE
144-151

eFTR
154-155

PERFORMANCE & SUSPENSION



HIGH MOUNT SLIP-ON EXHAUST BY AKRAPOVIČ

Add style and sound to your ride with these titanium and stainless steel slip-on high exhaust pipes by Akrapovič. The kit includes two matte black carbon fiber mounted heat shields covering the stainless steel link pipes. The titanium mufflers mount the system to an accessory mounting kit, sold separately. Passenger foot peg mount required for passengers, sold separately when using the high exhaust. Plus, conveniently change from low to high-mount exhaust with the conversion kit by Akrapovič; sold separately.

2883519 Titanium \$1,699.99

Fits 2019-2022 FTR models.



LOW MOUNT SLIP-ON EXHAUST BY AKRAPOVIČ

Akrapovič branded titanium or black and stainless steel slip-on exhaust pipe lends to the style of the FTR1200 with heart-thumping style and sound. The stainless link pipes are protected with a black matte carbon fiber heat shield. The system is mounted via the titanium or black mufflers to a steel bracket. Standard on FTR 1200 S Race Replica model. Plus, conveniently change from low to high-mount exhaust with the conversion kit by Akrapovič; sold separately.

2883520 Titanium \$1,499.99

2885006-266 Black \$1,599.99

Fits 2019-2022 FTR models.



HIGH MOUNT SLIP-ON EXHAUST CONVERSION KIT BY AKRAPOVIČ

Conveniently change your low mount slip-on exhaust by Akrapovič to a high-mount slip-on exhaust by Akrapovič using this conversion kit. The stainless steel link pipes are protected with black matte carbon fiber heat shields. The system is mounted via the titanium or black mufflers to a steel bracket. The mufflers from your low-mount exhaust kit are re-used to complete your Akrapovič exhaust system.

2884298 \$999.99

Fits 2019-2022 FTR models.

LOW MOUNT SLIP-ON EXHAUST BY AKRAPOVIČ

WHEELS & TIRES



ÖHLINS® INVERTED FRONT FORKS

Öhlins®, the world leader in high-performance and racing suspension technology, created these Inverted Front Forks specifically for the FTR to optimize its ride and handling in all conditions. The inner tubes of the forks have a stout diameter of 43mm, and the tubes are coated in premium titanium nitride for the most consistent and reliable performance. The forks are pre-load adjustable, and they have adjustable compression and rebound damping so a rider can customize the bike's suspension. These forks cannot be used on models with 19-inch front wheels.

2889062 \$1,799.99

Fits 2022 FTR models except FTR Rally.
Stock on 2022 FTR R Carbon.



ÖHLINS® REAR SHOCK

Öhlins®, the world leader in high-performance and racing suspension technology, created this Rear Shock specifically for the FTR to optimize the bike's ride and handling in all conditions. This shock features adjustable compression and rebound damping so riders can dial in rear suspension performance to suit their preferences. This shock has a piston rod diameter of 16 mm, and a 55 mm stroke that lets it swallow up bumps and smooth the ride. The shock body features an anodized finish and Öhlins® branding.

2889063 \$899.99

Fits 2022 FTR models except FTR Rally.
Stock on 2022 FTR R Carbon.



ÖHLINS® REAR SHOCK

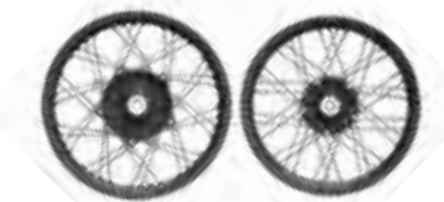

ALUMINUM SPOKE WHEEL SET

Get that truly classic look with this set of black anodized/powder-coated aluminum wire wheels with stainless steel spokes. The set includes a 19 in. x 3.0 in. front and an 18 in. x 4.25 in. rear with cast aluminum, black, powder coated hub and tubes for both. Tires not included.

2883509 \$1,299.99

Fits 2019-2020 FTR models.

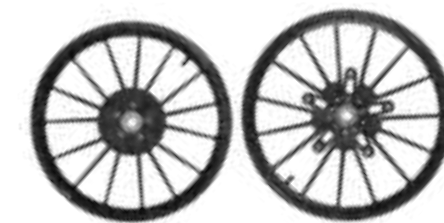

TRACKER WHEELS BY ROLAND SANDS DESIGN®

2884092 Black \$3,499.99

Dealer installation recommended.
Fits 2019-2020 FTR models.



SCORPION® RALLY STR TIRES BY PIRELLI®

5417164 Front \$189.99
5417165 Rear \$169.99

Fits 2019-2020 FTR models & 2022 FTR Rally.



2022

INTRO
2-11

FTR
12-27

SCOUT
28-51

INDIAN CHIEF
52-67

INDIAN SPRINGFIELD
68-91

CHIEFTAIN &
ROADMASTER
92-121

INDIAN CHALLENGER
122-135

POWERBAND AUDIO
136-139

COLOR-MATCHED
ACCESSORIES
140-143

GARAGE
144-151

eFTR
154-155

STORAGE & LUGGAGE



SIDE BAG & SIDE BAG RACK



MESSENGER BAG

It's always nice to have some extra tote space for everyday carry items, and the charcoal messenger bag is just the solution. The bag is water-resistant, has brown vinyl accents that match the Aviator Seat, a shoulder strap for off-bike use, and easily mounts to the Side Bag Rack (2883516), sold separately.

2883500-FBA \$279.99

Fits 2019-2022 FTR models.



REAR RACK BAG

This stylish Rear Rack Bag provides a versatile, innovative storage solution that can be expanded to increase its cargo capacity when needed. This bag attaches securely to the accessory Luggage Rack (2883511), sold separately for convenient cargo space that will not interfere with your riding. The bag has an integral double zipper that allows the exterior of the bag to expand and increase interior space to hold more cargo than when it is in its original form.

2884830-FBA \$259.99

Fits 2019-2022 FTR models.



TANK BAG

The charcoal Tank Bag is the simplest solution for adding more carry capacity to your FTR 1200. Vinyl accents match the Aviator Seat and a water-resistant phone holder provides touchscreen capability. The bag attaches to straps on the front and rear of the tank to keep it tight when the riding gets spirited.

2883517-FBA \$279.99

Fits 2019-2022 FTR models.



SIDE BAG

Getting caught in the rain on a ride is no fun, but having a water-resistant place to store things can be a life saver. The stylish black water-resistant Side Bag adds cargo capacity and mounts to the Side Bag Rack (2883516), sold separately.

2883514-FBA \$199.99

Fits 2019-2022 FTR models.



DUFFLE BAG

The water-resistant Duffel Bag is the perfect complement to your cargo setup off the bike. The bag comes with a shoulder strap and is made of the same material as the black Side Bag, sold separately.

2883518-FBA \$199.99

Fits 2019-2022 FTR models.



ACCESSORY MOUNTING KIT

The High Exhaust, High License Plate, Side Bag Rack, Side Number Plate and Rear Mudguard all require this accessory mounting kit for installation. Made from laser cut steel, E-coated and powder-painted black.

2883842 \$79.99

Fits 2019-2022 FTR models.



LUGGAGE RACK

Gear up for the long haul with the rear-mounted steel Luggage Rack. The black powder-coated rack includes the grab handle accessory with extension of the Luggage Rack.

2883511 \$249.99

Fits 2019-2022 FTR models.



SIDE BAG RACK

This steel powder-coated black rack is used to mount both the Messenger Bag and the black Side Bag, sold separately. The rack mounts to the Accessory Mounting Plates, sold separately at the rear of the bike and is required in order to mount the side bags.

2883516 \$129.99

Fits 2019-2022 FTR models.



2022

INTRO
2-11

FTR
12-27

SCOUT
28-51

INDIAN CHIEF
52-67

INDIAN SPRINGFIELD
68-91

CHIEFTAIN &
ROADMASTER
92-121

INDIAN CHALLENGER
122-135

POWERBAND AUDIO
136-139

COLOR-MATCHED
ACCESSORIES
140-143

GARAGE
144-151

eFTR
154-155

FTR PROTECTION



MID WINDSHIELD & WINDSHIELD MOUNT



MID WINDSHIELD

Make your ride more comfortable with this Mid Windshield that directs airflow to more desirable locations. Windscreen is drape-formed out of clear polycarbonate with hard coating and is easily removed or swapped out for the low windscreen.

2884009 With Headlight Cowl \$179.99
2883506 Without Headlight Cowl* \$179.99

Fits 2019-2022 FTR models.
Requires mounting kit, sold separately.
*Requires removal of stock headlight cowl.



LOW WIND DEFLECTOR

Stay comfortable yet sporty with this Wind Deflector that sits below your sight line. Drape-formed out of clear polycarbonate with hard coating, it features the Indian Motorcycle logo and is easily removed or swapped out for the Mid Windshield.

2884010 With Headlight Cowl \$149.99
2883507 Without Headlight Cowl* \$149.99

Fits 2019-2022 FTR models.
Requires mounting kit, sold separately.
*Requires removal of stock headlight cowl.



WINDSHIELD MOUNT

Made of steel and finished in black powder coat, the windshield mounting kit is required to mount the Low Wind Deflector or Mid Windshield. Includes all necessary mounting hardware.

2884011 \$249.99

Fits 2019-2022 FTR models.

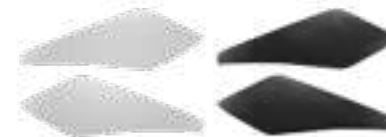

TANK PADS

Add a set of Tank Pads to protect your bike's finish and let you use body English on the "fuel tank" while cornering. These adhesive-backed pads attach easily to a clean air intake cover and they protect the surface finish against scratches and other damage. They give the bike a high-performance custom look since tank pads are commonly applied to the most powerful sport and race bikes. They let you press your legs aggressively against the intake cover when cornering without worrying about damaging the surface.

2884770 Transparent \$79.99
2884771 Black \$79.99

Fits 2019-2022 FTR models.



ALUMINUM RADIATOR GUARDS

Keep your fluids cool and your fins straight with these shot-blasted aluminum radiator covers with a clear, anodized finish to add equal measures of style and protection.

2883768 \$249.99

Fits 2019-2022 FTR models.



FORK GUARDS

Scared of damaging your fork seals? Don't be. These black injection-molded fork guards wear a textured finish that draws attention away from any dirt or grime.

2884103 \$99.99

Fits 2019-2020 FTR models & 2022 FTR Rally.



FRONT WHEEL DISC LOCK

Your motorcycle is yours. Keep it that way with the anti-theft security system designed by Roadlok®. The black anodized high-strength machined billet aluminum and stainless steel keep weight low and strength high. The tire-locking system is installed on your front caliper so it's there when you need it. Includes a stainless steel pin with Indian Motorcycle lanyard.

2883508 \$249.99

Fits 2019-2020 FTR models & 2022 FTR Rally.



FTR 1200 DUST COVER & ALL-WEATHER COVER

If you make the mistake of not riding your FTR 1200, don't make the mistake of leaving it uncovered. Choose between a soft, black nylon dust cover that is tailored, and goes on and comes off without a fuss. Or for solace in knowing your bike is safe and dry and ready to ride, choose the custom-fit, all-weather, PVC-coated cover.

2884102 Dust Cover \$179.99
2884190 All-Weather Cover* \$179.99

Fits 2019-2022 FTR models.

* This water-resistant polyester is engineered for outdoor storage. Indian Motorcycle makes no claims that this cover will protect your motorcycle in the event of a severe weather event.



2022

INTRO
2-11

FTR
12-27

SCOUT
28-51

INDIAN CHIEF
52-67

INDIAN SPRINGFIELD
68-91

CHIEFTAIN &
ROADMASTER
92-121

INDIAN CHALLENGER
122-135

POWERBAND AUDIO
136-139

COLOR-MATCHED
ACCESSORIES
140-143

GARAGE
144-151

eFTR
154-155

FTR COMFORT



R CARBON SEAT

The perfect complement to your bike's dynamic style and outstanding performance is this R Carbon Seat that features sleek styling and outstanding support. This seat features a ribbed design that helps you maintain the desired seating positions, and it has firm cushioning and design accents for premium style. It installs easily in place of the standard seat.

2885172 \$199.99

Fits 2019-2022 FTR models.
Stock on 2022 FTR R Carbon.



AVIATOR SEAT

A proper steed needs a proper saddle, and the brown vinyl-covered Aviator Seat is just that. This seat replaces the stock seat, allows for a passenger, is ideal for both long and short rides, and uses the same base as the stock seat and mounts to the bike effortlessly.

2883503-VNA \$299.99

Fits 2019-2022 FTR models.



TRACKER SEAT

The long, thin seat of a flat-track motorcycle allows the rider to easily and comfortably move around — a simple and handsome solution, available for your FTR 1200. This black, dimpled vinyl seat is longer than the stock seat and fits snugly against the required Tracker Seat Base Cowl, sold separately.

2884144-VBA \$199.99

Fits 2019-2022 FTR models.



RALLY HANDLEBAR BY PROTAPER®

Scramblin' is hard work. Keep hand fatigue to a minimum with these ProTaper® bars. Made out of T6 aluminum with a black anodized finish, these bars offer higher hand position and better control on-road or off.

2883769 \$119.99

Fits 2019-2022 FTR models.



HEATED GRIPS

Increase your comfort in cool weather and extend your riding season. Heated Grips install easily in place of the standard grips, and connect to the factory wiring harness with a single plug-and-play connection. You control the heat with a button on the left hand grip, and have a choice of three heat settings (low, medium, and high). An LED in that control button changes color to indicate the heat setting.

2884430 \$269.99

Fits 2019-2022 FTR models.



HANDLEBAR WAFFLE GRIPS BY PROTAPER®

Waffles are awesome, and so is the waffle-like pattern on this set of titanium gray ProTaper® rubber grips. Not only does the pattern look cool, it gives your hands extra soft and squishy material to squeeze.

2884100 \$29.99

Fits 2019-2022 FTR models.



GRAB HANDLE

Get a little extra security for your two-up trips with the black, powder-coated, rear-mounted steel Grab Handle.

2883512 \$129.99

Fits 2019-2022 FTR models.



USB CHARGING PORT

Enjoy the ability to power or charge electronic devices. It connects to the bike's wiring harness and conveniently positions a standard USB port the bike's instrumentation housing. It is ideal for powering or charging devices such as smart phones, GPS units, and more.

2885161 \$49.99

Fits 2019-2022 FTR models.
Stock on 2019-2020 models, 2022 FTR S, and FTR R Carbon.



PASSENGER FOOT PEG MOUNT FOR HIGH EXHAUST

Keep your passenger's feet planted when carving canyons or hitting the dirt. This cast aluminum, black-painted mount allows comfortable positioning on the right side when using the Akrapovič high exhaust. Requires re-use of the stock foot pegs.

2884069 \$99.99

Fits 2019-2022 FTR models.



RALLY FOOT PEGS BY PROTAPER®

These platform-style foot pegs feature a unique replaceable cleat design to keep your feet planted and in control, whatever the road throws your way.

2883521 \$279.99

Fits 2019-2022 FTR models.



RIDER FOOT PEG RUBBER INSERTS

Plug these Rider Foot Peg Rubber Inserts into your bike's pegs and you'll enjoy optimized foot grip and increased riding comfort. These inserts install easily into the standard pegs. They minimize foot slip and can help reduce vibration transmitted to the feet.

2885171 \$29.99

Fits 2019-2022 FTR models.
Stock on 2022 FTR models.



RAM® X-GRIP® PHONE MOUNT

The universal X-Grip® phone mount by RAM® keeps your phone in your field of view for navigating the road. It mounts to the mirror perch on the handlebar and fits phones up to 3.25 in. wide, including case. Just don't text and ride.

2884101 \$79.99

Fits 2019-2022 FTR models.



2022

INTRO
2-11

FTR
12-27

SCOUT
28-51

INDIAN CHIEF
52-67

INDIAN SPRINGFIELD
68-91

CHIEFTAIN &
ROADMASTER
92-121

INDIAN CHALLENGER
122-135

POWERBAND AUDIO
136-139

COLOR-MATCHED
ACCESSORIES
140-143

GARAGE
144-151

eFTR
154-155

RAM® X-GRIP® PHONE MOUNT

Scout Bobber Sixty



4.



5.

ACCESSORIES FEATURED

1. Scout Pathfinder LED Headlight, Pg. 46
2. Solo Rack Bag, Pg. 39
3. Solo Luggage Rack, Pg. 39
4. Rider Comfort Seat, Pg. 40
5. Radial RS Mirrors by Rizoma®, Pg. 48



1.



2.



3.

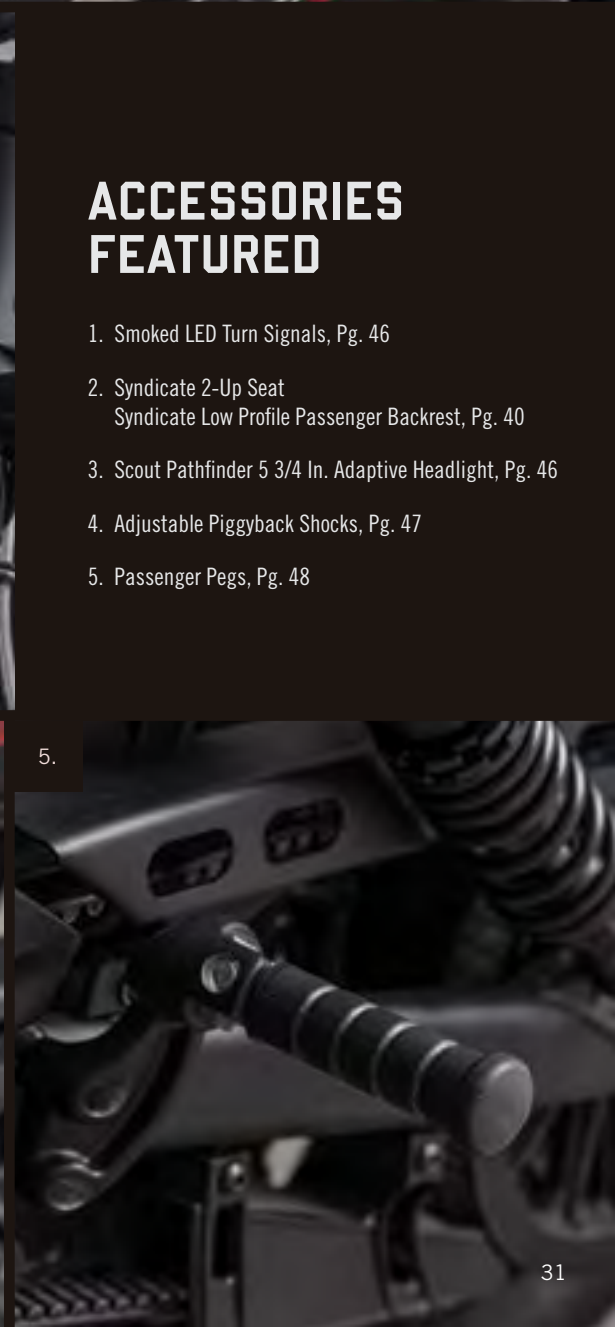

ACCESSORIES FEATURED

- 1. Smoked LED Turn Signals, Pg. 46
- 2. Syndicate 2-Up Seat
Syndicate Low Profile Passenger Backrest, Pg. 40
- 3. Scout Pathfinder 5 3/4 In. Adaptive Headlight, Pg. 46
- 4. Adjustable Piggyback Shocks, Pg. 47
- 5. Passenger Pegs, Pg. 48

Scout Bobber Twenty



ACCESSORIES FEATURED

1. 1920 Solo Saddle Seat & 1920 Solo Saddle Seat Close-Off, Pg. 40
2. Low Wind Deflector, Pg. 42
10 In. Ape Hanger Handlebar Kit, Pg. 44
3. Stage 1 2-into-1 Full Exhaust System, Pg. 38



Scout Sixty



5.



1.



3.



6.



2.



4.

ACCESSORIES FEATURED

1. Smoked Turn Signal Lenses, Pg. 46
2. Stage 1 Shorty Slip-On Muffler Kit, Pg. 38
3. Bar End Mirrors & Mount Kit, Pg. 49
4. Scout Pathfinder LED Headlight, Pg. 46
5. 1901 Low Fly Windscreen, Pg. 42
6. Tachometer with Shift Light, Pg. 48



ACCESSORIES FEATURED

1. Quick Release Fairing, Pg. 42
Scout Pathfinder 5 3/4 In. Adaptive LED Headlight, Pg. 46
2. Quick Release Passenger Sissy Bar & Backrest Pad, Pg. 41
3. 3-Setting Heated Grips, Pg. 45
4. Quick Release Semi-Rigid Saddlebags, Pg. 39
5. Vinyl Fairing Bag, Pg. 42



ENGINE PERFORMANCE



STAGE 1 2-INTO-1 FULL EXHAUST SYSTEM



TOP SELLER

STAGE 1 SHORTY SLIP-ON MUFFLER KIT

2884110-156 Chrome \$799.99
2884110-266 Black \$799.99

Increases horsepower by over 10% from the stock engine configuration when combined with the Performance Air Intake. See legal disclaimer at bottom of page. Requires Performance Air Intake (2882519), sold separately. Fits model year 2019-2022.



TOP SELLER

LOUVERED HEAT SHIELDS

2884115-156 Chrome \$199.99
2883482-266 Black \$189.99

Fits model year 2017-2022. Chrome is standard on 2020-2022 Scout Bobber Twenty. Black is standard on 2020-2022 Scout Bobber & Scout Bobber Sixty.



STAGE 1 STRAIGHTS SLIP-ON EXHAUST KIT

2882012-266 Black \$799.99

Enhance the sound of your bike with this Stage 1 Straights Slip-On Exhaust system. See legal disclaimer at bottom of page. Black exhaust kit is recommended with Exhaust Heat Shield (2884115-266), sold separately for Scout and Scout Sixty models. Fits model year 2017-2022.



TOP SELLER

PERFORMANCE AIR INTAKE

2882519 \$149.99

This Performance Air Intake lets the engine inhale more freely and deliver more power, quicker acceleration, and a quicker throttle response. This is a direct replacement for the standard motorcycle air intake and is required for the Stage 1 Shorty Slip-On Exhaust Kit and the Stage 1 2-into-1 Full Exhaust System, each sold separately. Dealer installation required. See legal disclaimer at bottom of page. Fits model year 2015-2022.



TOP SELLER

STAGE 1 2-INTO-1 FULL EXHAUST SYSTEM

2884111-156 Chrome \$1,299.99
2884111-266 Black \$1,299.99

Increases horsepower by over 10% from the stock engine configuration when combined with the Performance Air Intake. See legal disclaimer at bottom of page. Requires Performance Air Intake (2882519), sold separately. Fits model year 2019-2022.



STAGE 1 SHORTY SLIP-ON MUFFLER KIT

This kit meets EPA and CARB emission limits. Non-competition street use on motorcycles subject to USEPA noise limits & may violate federal noise limits. Please see inside back cover for further information.

Performance parts are 50 state emissions compliant. Non-competition street use on motorcycles subject to USEPA noise limits & may violate federal noise limits. Indian Motorcycle recognizes the importance of environmental laws that regulate exhaust and noise emissions and is committed to developing performance parts that allow motorcycle enthusiasts to modify their vehicles in a safe and responsible manner. Emissions / Safety: Federal and many state laws prohibit the removal, modification, or rendering inoperative any part installed on motor vehicles by Indian Motorcycle affecting emissions or safety on motor vehicles manufactured for use on a public street or highway. Violation may result in fines. International markets, please consult your local laws for additional information. Noise: Certain Indian Motorcycle performance parts are subject to noise-related usage restrictions. The warning statement for these parts includes the statement, "On road use of this product may violate federal law." These products are designed for use on closed course motorcycles only and do not conform to U.S. EPA noise emission standards. Use on motorcycles subject to EPA noise regulations constitutes tampering and is a violation of Federal law unless it can be shown that such use does not cause the motorcycle to exceed applicable Federal Standards.

Compliant with SAE® J2825 standard. Does not void factory warranty. This complete kit conveniently includes the required Calibration Code that upgrades the Engine Control Module (ECM) software from standard to Stage 1, allowing this kit to be properly installed by your dealer. No additional software purchase necessary. Each kit is designated with a warning triangle to indicate the restrictions that may apply.

STORAGE & LUGGAGE

TOP SELLER

SADDLEBAG

2884965-01 \$279.99

Fits 2018-2022 Scout Bobber, Scout Bobber Sixty & Scout Bobber Twenty.



QUICK RELEASE

QUICK RELEASE SEMI-RIGID SADDLEBAGS

2889282-VBA \$699.99

Requires Quick Release Accessory Mounting Spools (2881166), sold separately. Fits 2015-2022 Scout & Scout Sixty.



TOP SELLER

QUICK RELEASE

GENUINE LEATHER SADDLEBAGS

2880234-01 Black \$949.99
2880234-05 Desert Tan \$1,029.99

Requires Quick Release Accessory Mounting Spools (2881166), sold separately. Fits 2015-2022 Scout & Scout Sixty.



GENUINE LEATHER WINDSHIELD BAG

2880901-01 Black \$199.99
2880901-05 Desert Tan \$199.99

Windshield required (2880236-156, 2880237-156, 2880835-156, 2884167-156, 2884168-156, or 2884169-156), sold separately. Fits 2015-2022 Scout & Scout Sixty.



GENUINE LEATHER TANK POUCH

2880619-01 Black \$169.99

Does not fit Apple® iPhone® 6 or larger. Fits model year 2015-2022.



QUICK RELEASE

QUICK RELEASE ACCESSORY MOUNTING SPOOLS

2881166 \$159.99

Required to mount Quick Release Genuine Leather Saddlebags and/or the Quick Release or Bolt-On Passenger Sissy Bar to your motorcycle. Fits model year 2015-2022 Scout & Scout Sixty.



SOLO RACK BAG

2884113 \$259.99

Fits 2015-2022 Scout & Scout Sixty. Solo Luggage Rack (2885133) required, sold separately.



SOLO RACK BAG

2884862-VBA \$259.99

Fits 2018-2022 Scout Bobber, Scout Bobber Sixty & Scout Bobber Twenty. Shown attached to the Solo Luggage Rack (2882516-266), sold separately.



TOP SELLER

SOLO LUGGAGE RACK

2885133-156 Chrome \$209.99
2885133-266 Gloss Black \$209.99

Fits 2015-2022 Scout & Scout Sixty.



TOP SELLER

SOLO LUGGAGE RACK

2882516-266 Black \$249.99

Fits 2018-2022 Scout Bobber, Scout Bobber Sixty & Scout Bobber Twenty.



SISSY BAR LUGGAGE RACK

2881539-156 Chrome \$209.99

Requires the following: Backrest Pad (2880827-01, -05), Quick Release Passenger Sissy Bar (2880232-156 or -658), each sold separately. Fits 2015-2022 Scout & Scout Sixty.



2022

INTRO
2-11FTR
12-27SCOUT
28-51INDIAN CHIEF
52-67INDIAN SPRINGFIELD
68-91CHIEFTAIN &
ROADMASTER
92-121INDIAN CHALLENGER
122-135POWERBAND AUDIO
136-139COLOR-MATCHED
ACCESSORIES
140-143GARAGE
144-151eFTR
154-155

SEATS & BACKRESTS

NEW

SYNDICATE 2-UP SEAT

2889284-VBA Black \$399.99

Weather-resistant vinyl. Fits 2018-2022 Scout Bobber, Scout Bobber Sixty & Scout Bobber Twenty.



EXTENDED REACH SEAT

2880240-01 Black \$209.99
2880240-05 Desert Tan \$259.99

Made from either weather-resistant black vinyl or desert tan genuine leather. Recommended for riders 6'1" & over. Fits 2015-2022 Scout & Scout Sixty.



1920 SOLO SADDLE SEAT

2880905-01 Black \$389.99
2880905-05 Desert Tan \$389.99

Made from genuine leather. Kit includes close-off for Scout and Scout Sixty. Scout Bobber requires 1920 Solo Saddle Seat Close-Off (2882718), sold separately to cover subframe and battery. Fits model year 2015-2022.



SPORT SEAT

2884225-VBA Black Vinyl \$289.99
2884225-VTA Desert Tan Vinyl \$289.99

Fits 2015-2022 Scout & Scout Sixty. Standard on 2020-2022 Scout.



TOP SELLER

BOBBER PASSENGER SEAT

2883055-LNA Brown \$349.99
2883055-VBA Black \$329.99

Requires Passenger Pegs (2882251-650, -626), sold separately. Fits 2018-2022 Scout Bobber, Scout Bobber Sixty & Scout Bobber Twenty.



TOP SELLER

RIDER COMFORT SEAT

2889332-VNA Brown \$249.99
2889332-VBA Black \$249.99

Fits 2018-2022 Scout Bobber, Scout Bobber Sixty & Scout Bobber Twenty. Scout Bobber Twenty requires additional parts (5140611 & 5415423), sold separately. See dealer for details.



NEW

SYNDICATE LOW PROFILE PASSENGER BACKREST

2889429-VBA Black \$129.99

Requires Syndicate 2-Up Seat (2889284-VBA), sold separately. Fits 2018-2022 Scout Bobber, Scout Bobber Sixty & Scout Bobber Twenty.



REDUCED REACH SEAT

2880241-01 Black \$209.99
2880241-05 Desert Tan \$259.99

Made from either weather-resistant black vinyl or desert tan genuine leather. Recommended for riders 5'6" & under. Fits 2015-2022 Scout & Scout Sixty.



1920 SOLO SADDLE SEAT CLOSE-OFF

2882718 \$49.99

Covers frame and battery when 1920 Solo Saddle Seat (2880905-05, -01, required, sold separately) is installed. Fits 2018-2022 Scout Bobber & Scout Bobber Sixty.



TOURING PASSENGER SEAT

2880903-01 Black \$259.99
2880903-05 Desert Tan \$279.99

Wider for more comfort. Requires Passenger Pegs (2882251-650, -626), sold separately. All weather black vinyl. Genuine leather desert tan. Fits 2015-2022 Scout & Scout Sixty.



TOP SELLER

BOBBER PASSENGER SEAT WITH BACKREST

2882853-LNA Brown \$429.99
2882853-VBA Black \$419.99

Requires Passenger Pegs (2882251-650, -626), sold separately. Fits 2018-2022 Scout Bobber, Scout Bobber Sixty & Scout Bobber Twenty.



PASSENGER SEAT

2880134-01 Black \$209.99
2880134-05 Desert Tan \$209.99

Requires Passenger Pegs (2882251-650, -626), sold separately. All weather black vinyl. Genuine leather desert tan. Fits 2015-2022 Scout & Scout Sixty. Standard on 2018 Scout.



SYNDICATE 2-UP SEAT & SYNDICATE LOW PROFILE PASSENGER BACKREST

TOP SELLER

BACKREST PAD

2880827-01 Black \$169.99
2880827-05 Desert Tan \$209.99

Requires Rider Backrest Support (2880231-156, 2880985-156, or 2880871-156), Quick Release Passenger Sissy Bar (2880232-156, -658) & Bolt On Passenger Sissy Bar (2881127-650), each sold separately. All weather black vinyl. Genuine leather desert tan. Fits 2015-2022 Scout & Scout Sixty.



BOLT-ON PASSENGER SISSY BAR

2881127-650 Titanium Powder Coat Paint \$309.99

Requires Backrest Pad (2880827-01, -05) and Quick Release Accessory Mounting Spools (2881166), each sold separately. Fits 2015-2022 Scout & Scout Sixty.

TOP SELLER

QUICK RELEASE

QUICK RELEASE PASSENGER SISSY BAR

2880232-156 Chrome \$409.99
2880232-658 Black \$409.99

Requires Backrest Pad (2880827-01, -05) and Quick Release Mounting Spools (2881166), each sold separately. Fits 2015-2022 Scout & Scout Sixty.



RIDER BACKREST SUPPORT

2880231-156 Standard \$149.99
2880985-156 Reduced Reach \$139.99
2880871-156 Extended Reach \$139.99

Bolts into place at back of driver seat. Requires Backrest Pad (2880827-05, -01), sold separately. Standard recommended with standard Scout and Scout Sixty seats. Reduced Reach recommended with the Reduced Reach Seat. Extended Reach recommended with the Extended Reach Seat. Fits 2015-2022 Scout & Scout Sixty.



2022

INTRO
2-11FTR
12-27SCOUT
28-51INDIAN CHIEF
52-67INDIAN SPRINGFIELD
68-91CHIEFTAIN &
ROADMASTER
92-121INDIAN CHALLENGER
122-135POWERBAND AUDIO
136-139COLOR-MATCHED
ACCESSORIES
140-143GARAGE
144-151eFTR
154-155



QUICK RELEASE

QUICK RELEASE FAIRING

2884116 Unpainted \$799.99
2884116-XXX Color Options \$1,099.99

Comes standard with an 82% tint, 2 In. wind deflector. Headlight Relocation Kit (2884329) required, sold separately for Scout Bobber & Scout Bobber Twenty. Fits model year 2015-2022.

See page 140 for color options.

HEADLIGHT RELOCATION KIT

2884329 \$99.99

Required to install Quick Release Fairing on Scout Bobber. Fits 2018-2022 Scout Bobber & Scout Bobber Twenty.



PICKING THE RIGHT WINDSHIELD

The 1901 Low Fly Windscreen will give your bike a style boost. For riders looking for style and wind protection, choose the Quick Release Fairing and add the 5 In. or 7 In. windshield for more wind

and debris protection. For riders who prefer only a windshield, choose one that stops shortly below eye level to prevent looking through bug splatter, while directing air over your head.



10 In.

LOW WIND DEFLECTOR

2884689 10 In. 82% Tint \$119.99

Fits 2018-2022 Scout Bobber & Scout Bobber Twenty.



13 In.

MID WIND DEFLECTOR

2884688 13 In. 15% Tint \$129.99

Fits 2018-2022 Scout Bobber & Scout Bobber Twenty.



WIND DEFLECTOR MOUNT

2884677 \$179.99

Fits 2018-2022 Scout Bobber & Scout Bobber Twenty.



24 In.



21 In.



19 In.

QUICK RELEASE

TOP SELLER

QUICK RELEASE WINDSHIELDS

2880835-156 24 In. Chrome (shown) \$499.99
2884169-156 24 In. Chrome 17% Tint \$499.99
2880237-156 21 In. Chrome (shown) \$499.99
2884168-156 21 In. Chrome 17% Tint \$499.99
2880236-156 19 In. Chrome (shown) \$499.99
2884167-156 19 In. Chrome 17% Tint \$499.99

Fits 2015-2022 Scout, Scout Sixty & Scout Bobber Sixty.



WINDSHIELD FOR QUICK RELEASE FAIRING

2884295 5 In. Tinted \$179.99
2884296 7 In. Tinted \$179.99

Quick Release Fairing (2884116-XXX) comes standard with an 82% tint, 2 In. wind deflector. Add the 25% tint, 5 In. or 7 In. windshield for better wind and debris protection. Fits model year 2015-2022.

VINYL FAIRING BAG

2884678 \$139.99

Fits model year 2015-2022. Requires Quick Release Fairing (2884116-XXX), sold separately.



LOWER RIGID CLOSEOUTS

2884787 Black \$199.99

Requires Front Highway Bar (2881756-156, -266), sold separately. Fits model year 2015-2022.

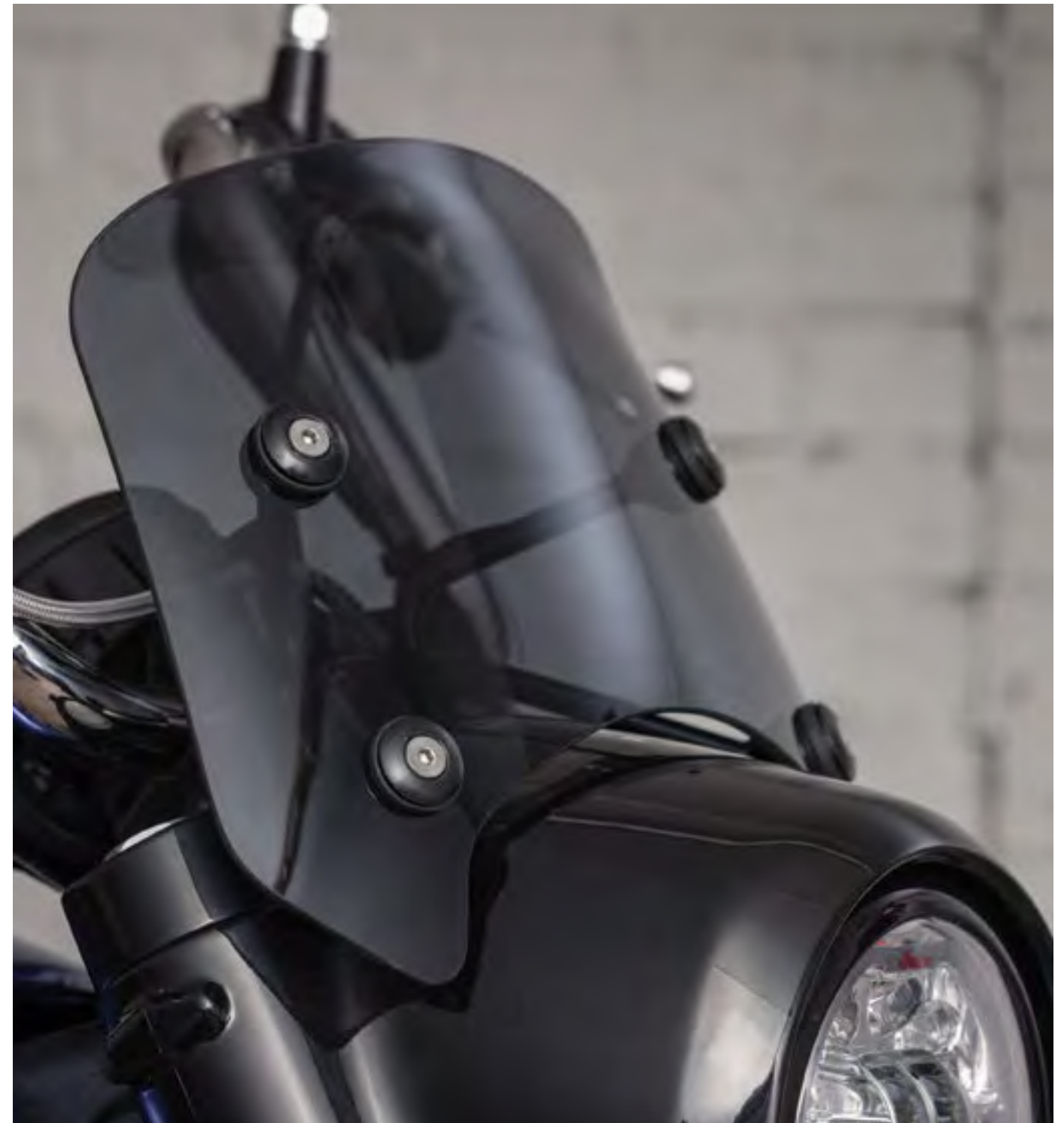

LOW WIND DEFLECTOR
& WIND DEFLECTOR MOUNT

FULL ACCESSORY DETAILS AVAILABLE AT [INDIANMOTORCYCLE.COM/ACCESSORIES](https://www.IndianMotorcycle.com/Accessories)



2022

INTRO
2-11

FTR
12-27

SCOUT
28-51

INDIAN CHIEF
52-67

INDIAN SPRINGFIELD
68-91

CHIEFTAIN &
ROADMASTER
92-121

INDIAN CHALLENGER
122-135

POWERBAND AUDIO
136-139

COLOR-MATCHED
ACCESSORIES
140-143

GARAGE
144-151

eFTR
154-155

HANDLEBARS & CONTROLS



3-SETTING HEATED GRIPS



TOP SELLER

10 IN. APE HANGER HANDLEBAR KIT*

2884012-266	Black	\$169.99
2884012-410	Polished Stainless	\$169.99

Installation on Scout Bobber & Scout Bobber Sixty requires Clutch Cable & Brake Line Kit, sold separately. Fits model year 2015-2022. Black comes standard on 2021-2022 Scout Bobber Twenty. Dealer installation required. Installation of accessory bars on Scout Bobber requires 2883638 K-Split Nut to reinstall Bar End Mirrors.



EXTENDED REACH HANDLEBAR

2889300-156	Chrome	\$199.99
2889300-266	Gloss Black	\$199.99

Recommended for riders 6'1" & over. Installation on Scout Bobber & Scout Bobber Sixty requires Clutch Cable & Brake Line Kit, sold separately. Fits model year 2015-2022. Dealer installation required.



TOP SELLER

REDUCED REACH HANDLEBAR

2889301-156	Chrome	\$199.99
2889301-266	Gloss Black	\$199.99

Recommended for riders 5'6" & under. Installation on Scout Bobber & Scout Bobber Sixty requires Clutch Cable & Brake Line Kit, sold separately. Fits model year 2015-2022. Dealer installation required.



BEACH BAR HANDLEBAR

2884130-156	Chrome	\$209.99
2884130-266	Gloss Black	\$209.99

Installation on Scout Bobber & Scout Bobber Sixty requires Clutch Cable & Brake Line Kit, sold separately. Fits model year 2015-2022. Dealer installation required.



DRAG BAR

2883641-463	Black	\$209.99
-------------	-------	----------

Dealer installation required. Fits 2015-2022 Scout & Scout Sixty. Standard on Scout Bobber & Scout Bobber Sixty. Does not fit ABS models.

3-SETTING HEATED GRIPS

2884667	Black	\$229.99
---------	-------	----------

Fits model year 2018-2022. Not compatible with Extended Reach Handlebar (2880152-410) or Reduced Reach Handlebar (2880153-410).



HANDLEBAR GRIPS

2882520-266	Black	\$69.99
-------------	-------	---------

Open-ended handlebar grips for bar end mirrors. Fits model year 2015-2022. Standard on Scout Bobber & Scout Bobber Twenty.



REDUCED REACH FOOT CONTROLS

2880239-650	Titanium	\$179.99
2880239-626	Black (shown)	\$179.99

Positions foot pegs and lower controls 2 in. closer than standard. Dealer installation recommended. Use standard foot pegs. Includes shortened shift linkage. Recommended for riders 5'6" & under. Fits 2015-2022 Scout & Scout Sixty.



TOP SELLER

OVERSIZED HANDLEBAR GRIPS

2881964-266	Black	\$69.99
-------------	-------	---------

Black oversize grips with Scout Logo. Fits model year 2015-2022.



TOP SELLER

CLUTCH CABLE & BRAKE LINE KIT

2883406	Non ABS models	\$109.99
2883864	2018 ABS models	\$109.99
2884164	2019-2022 ABS models	\$99.99

Required for installation of accessory handlebars (at right), sold separately. 2018-2022 Scout Bobber & Scout Bobber Sixty require 2883406. 2018 Scout Bobber & Scout Bobber Sixty with ABS require 2883864. 2019-2022 Scout Bobber & Scout Bobber Sixty with ABS require 2884164.



EXTENDED REACH FOOT CONTROLS

2880238-650*	Titanium (shown)	\$179.99
2883271-626**	Black	\$179.99

Positions foot pegs and lower controls 2 in. farther forward than standard. Dealer installation recommended. Use standard foot pegs. Includes extended shift linkage and extended brake line. Recommended for riders 6'1" & over. *Fits 2015-2022 Scout & Scout Sixty. **Fits 2018-2022 Scout Bobber.

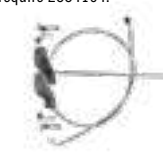

10 IN. APE HANGER HANDLEBAR KIT & HANDLEBAR GRIPS

FULL ACCESSORY DETAILS AVAILABLE AT [INDIANMOTORCYCLE.COM/ACCESSORIES](https://www.IndianMotorcycle.com/accessories)

2022

INTRO
2-11FTR
12-27SCOUT
28-51INDIAN CHIEF
52-67INDIAN SPRINGFIELD
68-91CHIEFTAIN &
ROADMASTER
92-121INDIAN CHALLENGER
122-135POWERBAND AUDIO
136-139COLOR-MATCHED
ACCESSORIES
140-143GARAGE
144-151eFTR
154-155



NEW
SCOUT PATHFINDER 5 3/4 IN.
ADAPTIVE LED HEADLIGHT

2884996-156 Chrome \$499.99
2884996-266 Black \$499.99

Monitors bike's lean angle real-time to deliver optimized illumination. 15 individual beams activate as needed. Optimized lighting in both low-beam and high-beam. Reduces glare from road and directs light where you need it. Fits model year 2015-2022.



TOP SELLER
SCOUT PATHFINDER LED HEADLIGHT

2882517 \$299.99

Fits model year 2015-2022.



NEW
SMOKED LED TURN SIGNALS

2889346 \$199.99

Fits 2018-2022 Scout Bobber.



TOP SELLER
SMOKED TURN SIGNAL LENSES

2884129 \$39.99

Fits 2015-2022 Scout & Scout Sixty.



USB CHARGING PORT HARNESS

2883689 \$79.99

Kit makes it easy to charge or power phones, audio sources, or GPS while riding. Kit includes everything needed for easy installation and reliable power. Accepts standard USB connection. Will provide power to virtually any mobile electronic device. Fits 2019-2022 Scout Sixty & Scout Bobber Sixty.



USB CHARGING PORT KIT

2883690 \$159.99

Easily to charge or power phones, audio sources, or GPS while riding. Kit includes everything needed for easy installation and reliable power. Accepts standard USB connection. Will provide power to virtually any mobile electronic device. Fits model year 2015-2018. Standard on 2019-2022 Scout, Scout Bobber & Scout Bobber Twenty.



LACED WHEELS

2880896-156 Front - Chrome \$519.99
2880896-266 Front - Gloss Black \$519.99
2880899-156 Rear - Chrome \$519.99
2880899-266 Rear - Gloss Black \$519.99

Recommended with Front Tire, 130/90-16 (5415575) and Rear Tire, 150/80-16 (5414555), each sold separately. Black option has chrome spokes with black rims and hubs. Fits model year 2015-2022. Black comes standard on 2020-2022 Scout Bobber Twenty.



NEW
ADJUSTABLE PIGGYBACK SHOCKS

2889273 Black \$799.99

Easy-to-use twist knob adjusts compression damping to suit rider's preferences. Piggyback reservoir shocks provide a smoother, more comfortable ride. Provides 3 in. of travel, one-third more than standard Scout Bobber shocks. Scout Bobber gains 1 in. ride height. Fits model year 2015-2022.

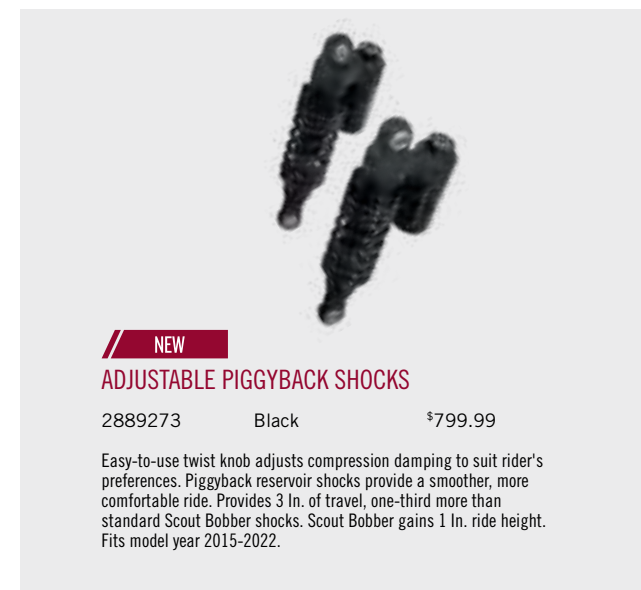

INDIAN PERFORMANCE SHOCKS BY FOX®

2881790-463 Black \$929.99

Kit includes 2 shocks, spanner wrench and instructions. Preload adjustable, installs in place of standard shocks. Scout Bobber gains 1 in. ride height. Fits model year 2015-2022.

These Indian Performance Shocks are tuned specifically for the Indian Scout to optimize the bike's high-performance ride and handling. These shocks have a gas-charged mono-tube with internal floating piston (IFP). They give a rider wide-range rebound adjustability and the coil spring offers preload adjustability. They have advanced high-flow, deflective disk, velocity-sensitive damping, and are fully rebuildable and revalveable.

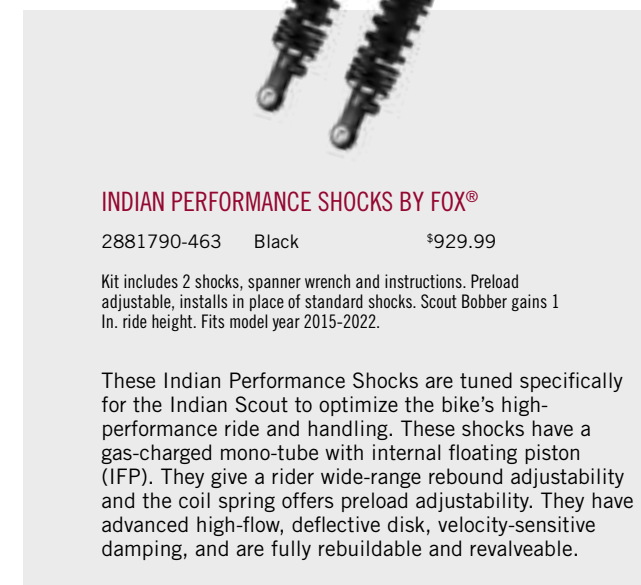

CRAFTED STYLE PIECES

TOP SELLER

FRONT HIGHWAY BARS

2881756-156 Chrome \$349.99
2881756-266 Black \$349.99

Fits model year 2015-2022.



LOWER RIGID CLOSEOUTS

2884787 Black \$199.99

Requires Front Highway Bar (2881756-156, -266), sold separately. Fits model year 2015-2022.



NEW

TACHOMETER WITH SHIFT LIGHT

2889304-01 Black/Black \$299.99
2889304-02 Tan/Chrome \$299.99

Provides rider with real-time, easy to read, engine RPM status. Fits model year 2015-2022.



TOP SELLER

RIDER FLOORBOARDS

2883056-658 Black \$309.99

Forged aluminum rider floorboards to give the ride a more cruiser look and feel. Increases rider comfort. Fits model year 2015-2022.



TOP SELLER

INFINITE HIGHWAY PEGS

2879572-156 Chrome \$309.99
2879572-266 Gloss Black \$309.99

Requires Highway Bars (2881756-156, -266), sold separately. Fits model year 2015-2022.



TOP SELLER

PASSENGER PEGS

2882251-650 Titanium* \$189.99
2882251-626 Black \$189.99

*Powder Coated Titanium. Fits model year 2015-2022. Standard on 2018 & 2020-2022 Scout.



PRIMARY ENGINE COVER

2881185-156 Chrome \$99.99
2881185-266 Black \$99.99
2881185-687 Bronze \$99.99

This Primary Engine Badge complements the bike's other accessories and features the Indian Motorcycle script logo. Fits model year 2015-2022.



HEADLIGHT BUCKET

2881328-156 Chrome \$89.99
2881328-687 Bronze \$89.99

This Headlight Bucket is a direct replacement for the standard headlight bucket and complements the other components and accessories on the bike. Fits 2015-2022 Scout, Scout Sixty & Scout Bobber Sixty.



BELT PULLEY COVER

2881326-156 Chrome \$204.99
2881326-687 Bronze \$204.99

This Belt Pulley Cover adds custom style and complements the bike's other chrome or bronze components and accessories, sold separately. Fits model year 2015-2022.



EXHAUST END CAPS

2881184-156 Chrome \$104.99
2881184-687 Bronze \$104.99

Exhaust End Caps enhance the custom treatment of Indian Scout and give the exhaust extra style. They install easily in place of the standard end caps. Only works with standard exhaust. Fits model year 2015-2022.



REAR SEAT BOLT

2881187 Chrome \$39.99

This Seat Bolt features the classic Indian Motorcycle headress. It replaces the standard seat fender bolt and gives your bike a finished look. Fits model year 2015-2022 Scout & Scout Sixty.



RADIAL RS MIRRORS BY RIZOMA®

2883771 Black \$369.99

Includes all necessary mounting hardware. These mirrors directly replace the standard mirrors and provide outstanding visibility. Fits model year 2015-2022.



TOP SELLER

PINNACLE MIRRORS

2880132-156 Chrome \$199.99

These mirrors feature a dynamic, laterally tapered design and have Indian Motorcycle script branding on the backsides. They are supported by forged arms for added strength and style. These mirrors directly replace the standard mirrors and provide outstanding visibility. Includes left and right-hand mirrors. Fits model year 2015-2022.



TOP SELLER

BLACK MIRRORS

2881013-463 Black \$129.99

These Black Mirrors greatly enhance the style of your motorcycle by helping to complete the blacked-out styling. These mirrors directly replace the standard mirrors and provide outstanding visibility. Fits model year 2015-2022. Standard on Scout Sixty & Scout Bobber Sixty.



FRONT HIGHWAY BARS & INFINITE HIGHWAY PEGS

BAR END MIRRORS & MOUNT KIT

2883730-468 Mirrors & Mount* \$179.99
2883638 Mount Kit** \$69.99

*Scout, Scout Sixty & Scout Bobber Sixty require Handlebar Grips (2882520-266), sold separately. Fits model year 2015-2022. Standard on Scout Bobber & Scout Bobber Twenty. **Required to add accessory handlebars and keep standard Bar End Mirrors. Fits 2018-2022 Scout Bobber & Scout Bobber Twenty.



REAR FENDER WASHERS

2881186-687 Bronze \$39.99

To complete the custom treatment of an Indian Scout install Rear Fender Washers to add bright style to the fender. Fits 2015-2022 Scout & Scout Sixty.



CLUTCH ARM COVER

2881188-156 Chrome \$69.99

This Clutch Arm Cover gives your bikes a clean, finished custom look, and it features a classic round Indian Motorcycle logo. It installs easily and infuses a mechanical element with innovative custom style. Fits model year 2015-2022.



1920 SOLO SADDLE GRAB RAIL

2881963-156 Chrome \$209.99
2881963-266 Black \$209.99

Chrome or black finish to complete the look of the 1920 Solo Saddle Seat (2880905-01, -05), required, sold separately. Scout Bobber also requires the 1920 Solo Saddle Seat Close-Off (2882718), sold separately. Fits model year 2015-2022.



UPPER BELT GUARD

2881314-156 Chrome \$159.99

This Upper Belt Guard infuses an Indian Scout with additional bright chrome that coordinates with all of the bike's chrome components and accessories. It replaces the standard belt guard and delivers reliable protection for the belt. Fits model year 2015-2022.



VENTED UPPER BELT GUARD

2882868-626 Black \$129.99

This Vented Upper Belt Guard infuses your bike with an extra dash of raw and aggressive style that complements the bike. Fits model year 2015-2022. Standard on 2018-2022 Scout Bobber & Scout Bobber Twenty.



2022

INTRO
2-11FTR
12-27SCOUT
28-51INDIAN CHIEF
52-67INDIAN SPRINGFIELD
68-91CHIEFTAIN &
ROADMASTER
92-121INDIAN CHALLENGER
122-135POWERBAND AUDIO
136-139COLOR-MATCHED
ACCESSORIES
140-143GARAGE
144-151eFTR
154-155

CRAFTED STYLE PIECES



2022

INTRO
2-11

FTR
12-27

SCOUT
28-51

INDIAN CHIEF
52-67

INDIAN SPRINGFIELD
68-91

CHIEFTAIN &
ROADMASTER
92-121

INDIAN CHALLENGER
122-135

POWERBAND AUDIO
136-139

COLOR-MATCHED
ACCESSORIES
140-143

GARAGE
144-151

eFTR
154-155



BILLET STYLE COLLECTION

This collection features authentic accessories that are made from forged billet aluminum. Choose between contrast cut or chrome to give your bike a high-quality custom look.

A. BILLET STATOR COVER

2881998-156 Chrome \$164.99
2881998-468 Contrast Cut \$169.99

Fits model year 2015-2022.



B. BILLET PRIMARY COVER

2881999-156 Chrome \$164.99
2881999-468 Contrast Cut \$169.99

Fits model year 2015-2022.



I. BILLET SHIFT RODS

Standard		Extended Reach		Reduced Reach	
2881994-468	Gloss Black Aluminum	2881995-468	Gloss Black Aluminum	2881996-468	Gloss Black Aluminum
2881994-472	Aluminum	2881995-472	Aluminum	2881996-472	Aluminum

\$79.99

Fits 2015-2022 Scout & Scout Sixty.



C. BILLET FRAME NECK INSERTS

2882004-156 Chrome \$289.99

Fits model year 2015-2022.



D. BILLET MIDFRAME COVER

2882006-156 Chrome \$309.99
2882006-468 Contrast Cut \$309.99

Fits model year 2015-2022.



J. BILLET FENDER STRUT COVER SET

2882007-156 Chrome \$184.99
2882007-468 Contrast Cut \$184.99

Fits 2015-2022 Scout & Scout Sixty.



K. BILLET MASTER CYLINDER COVERS

2882008-156 Chrome \$79.99

Fits model year 2015-2022.



E. BILLET FRONT CALIPER COVER

2882307-156 Chrome* \$79.99
2882307-468 Contrast Cut* \$79.99
2882009-156 Chrome** \$79.99
2882009-468 Contrast Cut** \$79.99

*Fits model year 2017-2022.
**Fits model year 2015-2016.



F. BILLET SHOCK STEM COVER SET

2882002-156 Chrome \$204.99
2882002-468 Contrast Cut \$204.99

Fits model year 2015-2022.



L. BILLET IGNITION COVER

2882000-156 Chrome \$259.99
2882000-468 Contrast Cut \$259.99

Fits 2015-2022 Scout & Scout Sixty.



M. BILLET THERMOSTAT COVER

2882001-156 Chrome \$259.99
2882001-468 Contrast Cut \$259.99

Fits model year 2015-2022.



TOP SELLER

G. BILLET SHIFT / BRAKE PEG

2882005-156 Chrome \$79.99
2882005-468 Contrast Cut \$69.99

Fits model year 2015-2022.



H. BILLET MUFFLER TIP SET

2882003-156 Chrome \$259.99
2882003-468 Contrast Cut \$259.99

Only compatible with standard exhaust. Fits model year 2015-2022.



Chief Dark Horse



ACCESSORIES FEATURED

1. Passenger Pillion, Pg. 60
Passenger Slim Backrest Pad &
Bolt-On Sissy Bar, Pg. 61
2. Thunderstroke Forward Stage 1 Air Intake, Pg. 58
3. Stage 1 Slip-On Exhaust & Slash Cut Exhaust Tips, Pg. 58
4. Passenger Pegs, Pg. 65

Chief Bobber Dark Horse



ACCESSORIES FEATURED

1. 1920 Solo Rider Saddle Seat, Pg. 60
2. Thunderstroke High Flow Stage 1 Air Intake, Pg. 58
3. Solo Rack, Pg. 60





ACCESSORIES FEATURED

1. Stage 1 Slip-On Exhaust & Fish Tail Exhaust Tips, Pg. 58
Saddlebags, Pg. 60
2. Pathfinder S LED Driving Lights &
Pathfinder S Driving Lights Mount, Pg. 66
3. Passenger Pillion, Pg. 60
Passenger Touring Backrest Pad & Quick Release Sissy Bar, Pg. 61
4. Front Highway Bars & Highway Bar Lower Closeouts, Pg. 63
Infinite Highway Pegs, Pg. 65
5. Quick Release Windshield, Pg. 62

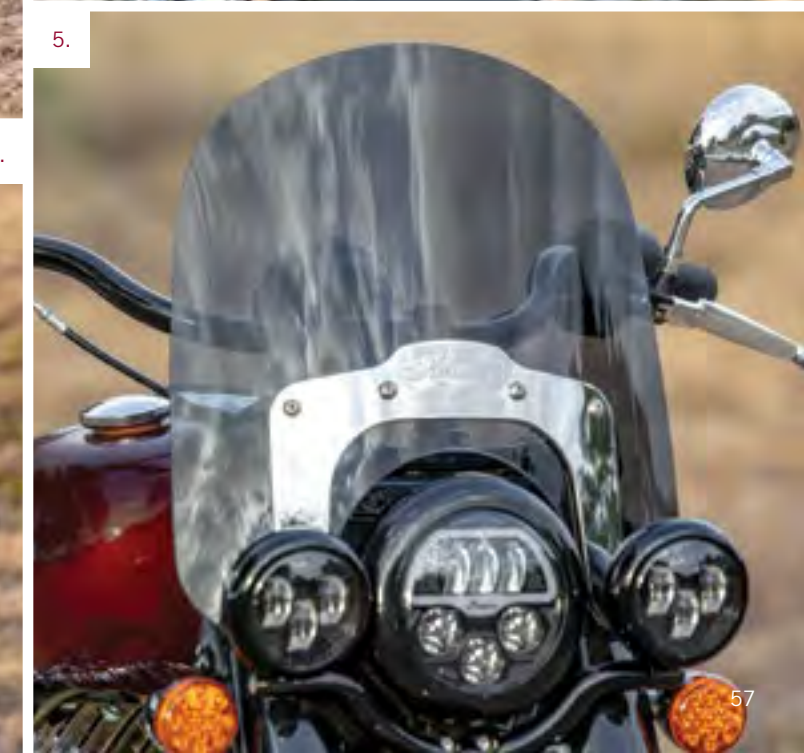

ENGINE PERFORMANCE



STAGE 1 SLIP-ON EXHAUST & SLASH CUT EXHAUST TIPS



STAGE 1 SLIP-ON EXHAUST

2884720-156 Chrome \$699.99
2884720-458 Matte Black \$699.99

Enjoy custom style and a louder, deeper exhaust note with this Stage 1 Slip-On Exhaust. This great-looking exhaust installs as a direct replacement for your bike's standard mufflers, and it features Indian Motorcycle branding near the tips. They produce a more robust and throaty exhaust note that enhances your bike's distinctive appeal. For enhanced custom style, install a set of Fish Tail Tips or Slash Cut Tips (required, each sold separately). Dealer installation required so the bike can be recalibrated for optimal performance with this exhaust. See legal disclaimer at bottom of right page. Fits model year 2022.



BLACK HEAT SHIELDS

2889217-458 Matte Black \$199.99

Fits model year 2022.



FISH TAIL EXHAUST TIPS

2884722-156 Chrome \$299.99
2884722-266 Black \$249.99

Stage 1 Slip-On Exhaust (2884720-XXX), required sold separately. Fits model year 2022.



SLASH CUT EXHAUST TIPS

2884721-156 Chrome \$299.99
2884721-266 Gloss Black \$249.99

Stage 1 Slip-On Exhaust (2884720-XXX), required sold separately. Fits model year 2022.



THUNDERSTROKE HIGH FLOW STAGE 1 AIR INTAKE

2880654-156 Chrome \$519.99
2880654-266 Gloss Black \$519.99

See legal disclaimer at bottom of right page. Dealer installation required. Fits model year 2022.



THUNDERSTROKE FORWARD STAGE 1 AIR INTAKE

2884950-156 Chrome \$549.99
2884950-266 Gloss Black \$549.99

Add high-performance style and provide proper airflow with this Thunderstroke Forward Stage 1 Air Intake. This air intake makes it clear that your bike is way beyond stock and is worth noticing. This is an ideal Air Intake to use with the Stage 1 Slip-On Exhaust. Dealer installation required for recalibration to ensure peak performance. See legal disclaimer at bottom of right page. Fits model year 2022.



TOP SELLER

THUNDERSTROKE STAGE 2 PERFORMANCE CAMS

2881676 \$569.99

Requires an Indian Motorcycle Stage 1 Muffler or Exhaust Kit and an Indian Motorcycle Stage 1 Air Intake, each sold separately. Increases horsepower by 13% and torque by 7% over the standard engine configuration. See legal disclaimer at bottom of page. Dealer installation required. Fits model year 2022.



TOP SELLER

THUNDERSTROKE STAGE 2 PERFORMANCE KIT

2884323 \$799.99

Requires an Indian Motorcycle Stage 1 Muffler or Exhaust Kit and an Indian Motorcycle Stage 1 Air Intake, each sold separately. See legal disclaimer at bottom of page. Fits model year 2022.



THUNDERSTROKE 116 CI STAGE 3 BIG BORE KIT

2885158 \$2,999.99

The Thunderstroke 116 ci Stage 3 Big Bore Kit will transform your Thunderstroke 111 into a powerhouse by delivering 20% more horsepower than a standard Thunderstroke 111 engine configuration. This kit also requires the Stage 1 Slip-On Muffler Kit, as well as a Thunderstroke Stage 1 Air Intake, each sold separately. See legal disclaimer at bottom of page. Dealer installation required. Fits model year 2022.

This kit meets EPA and CARB emission limits. Non-competition street use on motorcycles subject to USEPA noise limits & may violate federal noise limits. Please see inside back cover for further information.

This kit meets EPA emission limits. Not legal for sale or use on non-competition pollution controlled vehicles in California. Tampering with emission-related parts can lead to substantial regulatory penalties. Non-competition street use may violate federal noise limits.

Performance parts are 50 state emissions compliant. Non-competition street use on motorcycles subject to USEPA noise limits & may violate federal noise limits. Indian Motorcycle recognizes the importance of environmental laws that regulate exhaust and noise emissions and is committed to developing performance parts that allow motorcycle enthusiasts to modify their vehicles in a safe and responsible manner. Emissions / Safety: Federal and many state laws prohibit the removal, modification, or rendering inoperative any part installed on motor vehicles by Indian Motorcycle affecting emissions or safety on motor vehicles manufactured for use on a public street or highway. Violation may result in fines. International markets, please consult your local laws for additional information. Noise: Certain Indian Motorcycle performance parts are subject to noise-related usage restrictions. The warning statement for these parts includes the statement, "On road use of this product may violate federal law." These products are designed for use on closed course motorcycles only and do not conform to U.S. EPA noise emission standards. Use on motorcycles subject to EPA noise regulations constitutes tampering and is a violation of Federal law unless it can be shown that such use does not cause the motorcycle to exceed applicable Federal Standards.

Compliant with SAE® J2825 standard. Does not void factory warranty. This complete kit conveniently includes the required Calibration Code that upgrades the Engine Control Module (ECM) software from standard to Stage 1, allowing this kit to be properly installed by your dealer. No additional software purchase necessary. Each kit is designated with a warning triangle to indicate the restrictions that may apply.



2022

INTRO
2-11

FTR
12-27

SCOUT
28-51

INDIAN CHIEF
52-67

INDIAN SPRINGFIELD
68-91

CHIEFTAIN &
ROADMASTER
92-121

INDIAN CHALLENGER
122-135

POWERBAND AUDIO
136-139

COLOR-MATCHED
ACCESSORIES
140-143

GARAGE
144-151

eFTR
154-155

STORAGE & LUGGAGE



SADDLEBAGS

2884924-VBA Black \$999.99

Fits model year 2022. Stock on Super Chief & Super Chief Limited.



SOLO RACK

2884672-156 Chrome \$179.99
2884672-266 Gloss Black \$179.99

Fits model year 2022.



SOLO RACK BAG

2884862-VBA Black \$259.99

Fits model year 2022.

SADDLEBAG MOUNTING SPOOLS

2884925 \$149.99

Fits model year 2022. Stock on Super Chief & Super Chief Limited.



PASSENGER PILLION, PASSENGER SLIM BACKREST PAD & BOLT-ON SISSY BAR

SEATS & BACKRESTS

EXTENDED REACH SOLO SEAT

2884641-VBA Black - Chief \$199.99
2884641-VBC Black - Chief Bobber \$199.99
2884642-VBA Black - Super Chief \$199.99

This seat repositions the rider 15mm rearward and 30mm higher than the standard seat. 2884641-VBA and 2884641-VBC are not compatible with Passenger Pillion (2884622-XXX). Fits model year 2022.



1920 SOLO RIDER SADDLE SEAT

2884949-VBC Black \$239.99

Requires 1920 Solo Rider Saddle Seat Mount (2889113), sold separately. Fits model year 2022.



REDUCED REACH SEAT

2884643-VBA Black \$199.99

Fits model year 2022.



1920 SOLO RIDER SADDLE SEAT

2880905-01 Black \$389.99
2880905-05 Desert Tan \$389.99

Requires 1920 Solo Rider Saddle Seat Mount (2889113), sold separately. Fits model year 2022.



PASSENGER PILLION

2884644-VBA Black - Chief \$199.99
2884644-VBC Black - Chief Bobber \$199.99

Not compatible with Extended Reach Solo Seat (2884641-XXX), sold separately. Fits model year 2022.



1920 SOLO RIDER SADDLE SEAT MOUNT

2889113 Black \$149.99

Fits model year 2022.



PASSENGER TOURING BACKREST PAD

2884801-VBA Black \$149.99

Quick Release Sissy Bar (2884632-156, -266) or Bolt-On Sissy bar (2884631-156, -266) required, sold separately. Fits model year 2022.



BOLT-ON SISSY BAR

2884631-156 Chrome \$299.99
2884631-266 Gloss Black \$299.99

Passenger Backrest Pad (2884801-VBA, 2884802-VBA), required sold separately. Not compatible with Saddlebags (2884924-VBA), sold separately. Fits model year 2022.



PASSENGER SLIM BACKREST PAD

2884802-VBA Black \$149.99

Quick Release Sissy Bar (2884632-156, -266) or Bolt-On Sissy bar (2884631-156, -266) required, sold separately. Fits model year 2022.



QUICK RELEASE SISSY BAR

2884632-156 Chrome \$299.99
2884632-266 Gloss Black \$299.99

Add a matching Passenger Backrest Pad (2884801-VBA, 2884802-VBA), sold separately. Saddlebag Spool Kit (2884925), sold separately is required if spools are not standard on your bike. Fits model year 2022.



2022

INTRO
2-11

FTR
12-27

SCOUT
28-51

INDIAN CHIEF
52-67

INDIAN SPRINGFIELD
68-91

CHIEFTAIN &
ROADMASTER
92-121

INDIAN CHALLENGER
122-135

POWERBAND AUDIO
136-139

COLOR-MATCHED
ACCESSORIES
140-143

GARAGE
144-151

eFTR
154-155



23.8 IN. QUICK RELEASE WINDSHIELD



FRONT HIGHWAY BAR, HIGHWAY BAR LOWER CLOSEOUTS & INFINITE HIGHWAY PEGS



A. 17.8 In. B. 17.8 In. C. 23.8 In. D. 23.8 In. E. 26.8 In. F. 26.8 In.

QUICK RELEASE

QUICK RELEASE WINDSHIELDS & DEFLECTORS

A.	2884940-266	17.8 In. Tinted Low - Gloss Black	\$499.99
B.	2884940-410	17.8 In. Tinted Low - Polished	\$479.99
C.	2884941-266	23.8 In. Tinted Mid - Gloss Black	\$499.99
D.	2884941-410	23.8 In. Tinted Mid - Polished	\$479.99
E.	2884693-266	26.8 In. Tall - Gloss Black	\$499.99
F.	2884693-410	26.8 In. Tall - Polished	\$479.99

A Quick Release Windshield Mounting Kit (2884864-266), sold separately, is required if your bike is not equipped with a nacelle. Bikes with a nacelle require Quick Release Windshield Mounting Spools (2884902-266), sold separately. Fits model year 2022.

PICKING THE RIGHT WINDSHIELD

For riders looking for wind protection, a windshield that stops shortly below eye level will prevent you from looking through bug splatter, while directing air over your head. For riders 5'6" and under, the 17.8 In. is recommended, for riders 5'6" to 6'1" the 23.8 In. is recommended and the 26.8 In. is recommended for riders 6'2" and above.



QUICK RELEASE

QUICK RELEASE WINDSHIELD MOUNTING KIT

2884864-266 Gloss Black \$199.99

Required on Chief models for windshield installation. Quick Release Windshield Mounting Spools included. Fits model year 2022.



QUICK RELEASE

QUICK RELEASE WINDSHIELD MOUNTING SPOOLS

2884902-266 Gloss Black \$59.99

Required on Chief Bobber models to install windshield. Fits model year 2022.



FRONT HIGHWAY BARS

2884718-156 Chrome \$349.99
2884718-266 Gloss Black \$349.99

Fits model year 2022.



HIGHWAY BAR LOWER CLOSEOUTS

2884901-VBA Black \$169.99

Fits model year 2022.



2022

INTRO
2-11

FTR
12-27

SCOUT
28-51

INDIAN CHIEF
52-67

INDIAN SPRINGFIELD
68-91

CHIEFTAIN &
ROADMASTER
92-121

INDIAN CHALLENGER
122-135

POWERBAND AUDIO
136-139

COLOR-MATCHED
ACCESSORIES
140-143

GARAGE
144-151

eFTR
154-155

HANDLEBARS & CONTROLS



MINI APE HANDLEBARS, 1920 SOLO SADDLE SEAT, STAGE 1 SLIP-ON EXHAUST & SLASH CUT EXHAUST TIPS



REDUCED REACH HANDLEBAR

2884997-266 Gloss Black \$179.99

Short installation kit may be required depending upon model. To determine which models need an install kit, reference the install kit matrix under this product listing on indianmotorcycle.com. Fits model year 2022.



CRUISER HANDLEBARS

2884999-266 Gloss Black \$179.99

Mid installation kit may be required depending upon model. To determine which models need an install kit, reference the install kit matrix under this product listing on indianmotorcycle.com. Stock on Super Chief & Super Chief Limited models. Fits model year 2022.



MINI APE HANDLEBARS*

2885001-266 Gloss Black \$179.99

Tall installation kit required. Fits model year 2022.



5 IN. MID RISE HANDLEBAR*

2884998-266 Gloss Black \$179.99

Mid installation kit may be required depending upon model. To determine which models need an install kit, reference the install kit matrix under this product listing on indianmotorcycle.com. Stock on Chief Bobber & Chief Bobber Dark Horse models. Fits model year 2022.



DRAG HANDLEBARS

2885000-266 Gloss Black \$179.99

Short installation kit may be required depending upon model. To determine which models need an install kit, reference the install kit matrix under this product listing on indianmotorcycle.com. Stock on Chief & Chief Dark Horse models. Fits model year 2022.



HANDLEBAR INSTALL KITS

2885099 Short \$149.99
2885100 Mid \$149.99
2885101 Tall \$149.99

Dealer installation required. Fits model year 2022.



SELECT HANDLEBAR GRIPS

2882828-156 Chrome \$179.99
2882828-468 Black \$179.99

Fits model year 2022.



HEATED HANDLEBAR GRIPS

2884900 Black \$249.99

Bikes with nacelle require Nacelle Accessory Switch Mount (2884951-266), sold separately. Dealer installation required. Fits model year 2022.

SELECT RIDER FLOORBOARDS

2883021-156 Chrome \$519.99
2883021-468 Black \$519.99

Fits model year 2022.



SELECT HEEL SHIFTER PEG

2880729-156 Chrome \$49.99
2880729-468 Matte Black \$49.99

Attaches to the Pinnacle Heel Shifter (2884772-XXX), required, sold separately. Fits model year 2022.



TOP SELLER

INFINITE HIGHWAY PEGS

2879572-156 Chrome \$309.99
2879572-266 Gloss Black \$309.99

Requires highway bars, sold separately, see page 63. Fits model year 2022.



BILLET SHIFT / BRAKE PEG

2882005-156 Chrome \$79.99
2882005-468 Contrast Cut \$59.99

Requires Mid Foot Controls with Pegs (2889214-266) or Forward Foot Controls with Pegs (2889215-266), each sold separately. Fits model year 2022.



MID FOOT CONTROLS WITH PEGS

2889214-266 Black \$299.99

Dealer installation required. Fits model year 2022. Stock on Chief & Chief Dark Horse models.



FORWARD FOOT CONTROLS WITH FLOORBOARDS

2889216-266 Black \$449.99

Dealer installation required. Fits model year 2022. Stock on Super Chief & Super Chief Limited models.



TOP SELLER

HEADRESS RIDER FLOORBOARD PADS

2879606-01 Polished Inlays \$209.99

Use the Headdress Rider Floorboard Pads with your standard floorboards for an extra boost of style. Fits model year 2022.



PASSENGER PEGS

2889213-266 Gloss Black \$189.99

Fits model year 2022. Stock on Super Chief & Super Chief Limited.



TOE RESTS

2881848-156 Chrome \$179.99

Requires highway bars, sold separately, see page 63. Fits model year 2022.



TOP SELLER

SELECT TOE PEG

2880728-156 Chrome \$79.99
2880728-468 Matte Black \$79.99

Installs in place of the standard toe shifter peg and adds a great looking accessory to your Indian Motorcycle. Compatible with Forward Foot Controls with Floorboards (2889216-266) sold separately. Must purchase two Select Toe Pegs. Fits model year 2022.



FORWARD FOOT CONTROLS WITH PEGS

2889215-266 Black \$349.99

Dealer installation required. Fits model year 2022. Stock on Chief Bobber & Chief Bobber Dark Horse models.



2022

INTRO
2-11

FTR
12-27

SCOUT
28-51

INDIAN CHIEF
52-67

INDIAN SPRINGFIELD
68-91

CHIEFTAIN &
ROADMASTER
92-121

INDIAN CHALLENGER
122-135

POWERBAND AUDIO
136-139

COLOR-MATCHED
ACCESSORIES
140-143

GARAGE
144-151

eFTR
154-155

* Handlebar heights are regulated by state and local laws. Accessory handlebars may not be legal in all areas or for all riders. Check state and local regulations. Follow all installation instructions to ensure that the handlebars are securely in place and are appropriate for rider size, control, and visibility.



2022

INTRO
2-11

FTR
12-27

SCOUT
28-51

INDIAN CHIEF
52-67

INDIAN SPRINGFIELD
68-91

CHIEFTAIN &
ROADMASTER
92-121

INDIAN CHALLENGER
122-135

POWERBAND AUDIO
136-139

COLOR-MATCHED
ACCESSORIES
140-143

GARAGE
144-151

eFTR
154-155



PATHFINDER S LED DRIVING LIGHTS & PATHFINDER S DRIVING LIGHTS MOUNT



PATHFINDER S LED DRIVING LIGHTS

2884708-156	Chrome	\$199.99
2884708-266	Gloss Black	\$199.99

Installed easily with the Pathfinder S LED Driving Lights Mount (2884775-XXX), sold separately. Fits model year 2022.



PATHFINDER S DRIVING LIGHTS MOUNT

2884775-156	Chrome	\$279.99
2884775-266	Gloss Black	\$279.99

Requires Pathfinder S LED Driving Lights (2884708-XXX), sold separately. If a nacelle is installed, Nacelle Accessory Switch Mount (2884951-266), required, sold separately. Fits model year 2022.



NACELLE ACCESSORY SWITCH MOUNT

2884951-266	Gloss Black	\$69.99
-------------	-------------	---------

Fits model year 2022.



1920 SOLO SADDLE GRAB RAIL

2881963-156	Chrome	\$209.99
2881963-266	Gloss Black	\$209.99

Chrome or black finish to complete the look of the 1920 Solo Rider Saddle Seat (2884949-01, -05), required, sold separately. Fits model year 2022.



PINNACLE MIRRORS

2880132-156	Chrome	\$199.99
-------------	--------	----------

Not compatible when Drag Handlebars (2885000-266) and Quick Release Tall Windshield (2884693-266, -410) are both installed, each sold separately. Fits model year 2022.



NEW
LOCKING FUEL CAP

2884600-156	Chrome	\$79.99
2884600-266	Black	\$79.99

Includes one locking fuel cap, two keys and installation instructions. Fits model year 2022.



ACCESSORIES FEATURED

1. Genuine Leather Partial Mustache Highway Bar Wraps, Pg. 90
2. Genuine Leather Tank Pouch, Pg. 76
3. Genuine Leather Grip Wraps, Pg. 90
4. Infinite Highway Pegs, Pg. 85
5. Genuine Leather Floorboard Trim, Pg. 90
6. Genuine Leather Rear Highway Bar Bag, Pg. 76





ACCESSORIES FEATURED

1. Thunderstroke Stage 1 Slip-On Exhaust Kit, Pg. 72 & Straight Exhaust Tips, Pg. 74
2. 12 In. Ape Hanger Handlebar Kit, Pg. 84 & Pathfinder Adaptive LED Headlight, Pg. 86
3. Thunderstroke Forward Stage 1 Air Intake, Pg. 72

ENGINE PERFORMANCE



STAGE 1 OVAL SLIP-ON MUFFLER KIT



TOP SELLER

STAGE 1 OVAL SLIP-ON MUFFLER KIT

2884187-156 Chrome \$999.99
2884187-266 Black \$999.99

See legal disclaimer at bottom of right page. Fits model year 2016-2022.



TOP SELLER

THUNDERSTROKE STAGE 1 SLIP-ON EXHAUST KIT

2879769-156 Chrome \$699.99
2879769-266 Matte Black \$699.99

Requires exhaust tips, sold separately. See legal disclaimer at bottom of right page. Fits model year 2016-2022.



CHIEF DARK HORSE & VINTAGE THUNDERSTROKE STAGE 1 SLIP-ON EXHAUST KIT

2879768-156 Chrome \$699.99
2879768-266 Matte Black \$699.99

Requires exhaust tips, sold separately. See legal disclaimer at bottom of right page. Fits 2014-2021 Vintage, Vintage Dark Horse & Chief Dark Horse.



TOP SELLER

THUNDERSTROKE HIGH FLOW AIR INTAKE

2880654-156 Chrome \$519.99
2880654-266 Gloss Black \$519.99

See legal disclaimer at bottom of right page. Dealer installation required. Fits model year 2016-2022.



TOP SELLER

THUNDERSTROKE STAGE 1 PERFORMANCE AIR INTAKE

2881779-156 Chrome \$519.99
2881779-521 Matte Black \$519.99

See legal disclaimer at bottom of right page. Fits model year 2016-2022.



THUNDERSTROKE FORWARD STAGE 1 AIR INTAKE

2884950-156 Chrome \$549.99
2884950-266 Gloss Black \$549.99

Add high-performance style and provide proper airflow with this Thunderstroke Forward Stage 1 Air Intake. This air intake makes it clear that your bike is way beyond stock and is worth noticing. This is an ideal Air Intake to use with the Stage 1 Slip-On Exhaust. Dealer installation required for recalibration to ensure peak performance. See legal disclaimer at bottom of right page. Fits model year 2016-2022.



TOP SELLER

THUNDERSTROKE STAGE 2 PERFORMANCE KIT

2884323 \$799.99

Requires an Indian Motorcycle Stage 1 Muffler or Exhaust Kit and an Indian Motorcycle Stage 1 Air Intake, each sold separately. See legal disclaimer at bottom of page. Fits 2020-2022 Indian Springfield Dark Horse with Thunderstroke 116 engine.



TOP SELLER

THUNDERSTROKE STAGE 2 PERFORMANCE CAMS

2881676 \$569.99

Requires an Indian Motorcycle Stage 1 Muffler or Exhaust Kit and an Indian Motorcycle Stage 1 Air Intake, each sold separately. Increases horsepower by 13% and torque by 7% over the standard engine configuration. See legal disclaimer at bottom of page. Dealer installation required. Fits 2016-2022 models with Thunderstroke 111 engine.



A.



B.

THUNDERSTROKE 116 CI STAGE 3 BIG BORE KIT

A. 2885158 2021-2022* \$2,999.99
B. 2883921 2019-2021 \$2,749.99
C. 2884062 2014-2018 (not shown) \$2,749.99

The Thunderstroke 116 ci Stage 3 Big Bore Kit will transform your Thunderstroke 111 into a powerhouse by delivering 20% more horsepower than a standard Thunderstroke 111 engine configuration. This kit also requires the Stage 1 Oval Slip-On Muffler Kit, or the Thunderstroke Stage 1 Slip-On Exhaust Kit as well as the Thunderstroke Stage 1 Performance Air Intake or Thunderstroke High Flow Air Intake, each sold separately. See legal disclaimer at bottom of page. Dealer installation required. Fits model year 2014-2022. *2885158 fits 2021-2022 Indian Springfield.

This kit meets EPA and CARB emission limits. Non-competition street use on motorcycles subject to USEPA noise limits & may violate federal noise limits. Please see inside back cover for further information.

Performance parts are 50 state emissions compliant. Non-competition street use on motorcycles subject to USEPA noise limits & may violate federal noise limits. Indian Motorcycle recognizes the importance of environmental laws that regulate exhaust and noise emissions and is committed to developing performance parts that allow motorcycle enthusiasts to modify their vehicles in a safe and responsible manner. Emissions / Safety: Federal and many state laws prohibit the removal, modification, or rendering inoperative any part installed on motor vehicles by Indian Motorcycle affecting emissions or safety on motor vehicles manufactured for use on a public street or highway. Violation may result in fines. International markets, please consult your local laws for additional information. Noise: Certain Indian Motorcycle performance parts are subject to noise-related usage restrictions. The warning statement for these parts includes the statement, "On road use of this product may violate federal law." These products are designed for use on closed course motorcycles only and do not conform to U.S. EPA noise emission standards. Use on motorcycles subject to EPA noise regulations constitutes tampering and is a violation of Federal law unless it can be shown that such use does not cause the motorcycle to exceed applicable Federal Standards.

Compliant with SAE® J2825 standard. Does not void factory warranty. This complete kit conveniently includes the required Calibration Code that upgrades the Engine Control Module (ECM) software from standard to Stage 1, allowing this kit to be properly installed by your dealer. No additional software purchase necessary. Each kit is designated with a warning triangle to indicate the restrictions that may apply.



2022

INTRO
2-11

FTR
12-27

SCOUT
28-51

INDIAN CHIEF
52-67

INDIAN SPRINGFIELD
68-91

CHIEFTAIN &
ROADMASTER
92-121

INDIAN CHALLENGER
122-135

POWERBAND AUDIO
136-139

COLOR-MATCHED
ACCESSORIES
140-143

GARAGE
144-151

eFTR
154-155

ENGINE PERFORMANCE



STRAIGHT EXHAUST TIPS

2880671-156	Chrome	\$259.99
2880671-266	Matte Black	\$259.99

Machined billet aluminum with the largest inner-diameter giving these straight tips the deepest sound. Requires Stage 1 Exhaust (2879768-156, -266 or 2879769-156, -266), sold separately. Fits model year 2016-2022.



FISH TAIL EXHAUST TIPS

2879532-156	Chrome	\$209.99
2879532-266	Matte Black	\$209.99

Stamped steel and classic styling. Requires Stage 1 Exhaust (2879768-156, -266 or 2879769-156, -266), sold separately. Fits model year 2016-2022.

TOP SELLER



SIX SHOOTER EXHAUST TIPS

2879530-156	Chrome	\$309.99
2879530-266	Matte Black	\$309.99

Choose between 4 different mounting screw hole locations to position the exhaust tips to suit your style. Made of cast aluminum. Requires Stage 1 Exhaust (2879768-156, -266 or 2879769-156, -266), sold separately. Fits model year 2016-2022.



GROOVED EXHAUST TIPS

2880799-156	Chrome	\$309.99
2880799-266	Matte Black	\$309.99

Most visible from the road. Made of billet aluminum. Requires Stage 1 Exhaust (2879769-156, -266), sold separately. Fits model year 2016-2022.



THUNDERSTROKE PERFORMANCE CLUTCH KIT

2883957	\$309.99
---------	----------

This Performance Clutch Kit enhances clutch durability and reliability on a bike equipped with Indian Motorcycle high-performance stage kits. Fits model year 2016-2020 & 2021 Vintage & Vintage Dark Horse & 2022 Indian Springfield Dark Horse.



EXHAUST SHIELDS

2883245	Matte Black*	\$279.99
2885129	Matte Black**	\$279.99

Steel with a matte black finish. Direct replacement for existing heat shields. *Fits model year 2014-2020, 2021 Vintage & Vintage Dark Horse & 2021-2022 Indian Springfield Dark Horse. Standard on 2019-2020 Indian Springfield Dark Horse. **Fits 2021-2022 Indian Springfield.



OIL COOLER

2880668	\$309.99
---------	----------

Includes oil cooler assembly, oil lines, adapter and installation hardware. Fits model year 2016-2022.



THUNDERSTROKE FORWARD STAGE 1 AIR INTAKE



2022

INTRO
2-11

FTR
12-27

SCOUT
28-51

INDIAN CHIEF
52-67

INDIAN SPRINGFIELD
68-91

CHIEFTAIN &
ROADMASTER
92-121

INDIAN CHALLENGER
122-135

POWERBAND AUDIO
136-139

COLOR-MATCHED
ACCESSORIES
140-143

GARAGE
144-151

eFTR
154-155

STORAGE & LUGGAGE

SADDLEBAG LID RACKS

2883402-156 Chrome \$359.99

Fits 2016-2022 Indian Springfield & 2018 Indian Springfield Dark Horse.



GENUINE LEATHER REAR HIGHWAY BAR BAG

2880297-01 Black \$209.99
2880297-05 Desert Tan \$229.99

Velcro® strips hold lid closed. Detachable genuine leather water bottle holder attaches to the left Rear Highway Bar (2879582-156, -266), required, sold separately. Fits model year 2016-2022.



GENUINE LEATHER HANDLEBAR BAG

2879577-01 Black \$189.99
2879577-05 Desert Tan \$209.99

Attaches securely to nacelle near handlebars. Formed liner maintains shape. Bag features a small strap for securing a power adapter/charger, which can be connected to the 12 Volt Power Cord (2880105), sold separately, to power small items while riding. Pinnacle Concho required (2879674-266, -639, -640), sold separately. Does not work with 12 in. or 16 in. Ape Hanger Handlebars. Fits model year 2016-2022.



GENUINE LEATHER SADDLEBAGS

2884005-02 Black \$1,389.99
2884005-06 Desert Tan \$1,389.99

Premium leather exterior with durable molded interior. Strong buckles underneath leather straps. Strut cover and spool kit (2883998-156, -266), required, sold separately. Fits model year 2016-2022.



TOP SELLER DELUXE SADDLEBAG TRAVEL BAGS

2885131 Black \$154.99

Fits model year 2016-2022.



DELUXE TRUNK TRAVEL BAG

2885132 Black \$144.99

Fits model year 2016-2022 when equipped with a Quick Release Trunk (2884046-XXX), sold separately.



TOP SELLER

PINNACLE SOLO LUGGAGE RACK

2885004-156 Chrome \$309.99
2885004-266 Gloss Black \$309.99

Fits model year 2016-2022.



TOP SELLER

GENUINE LEATHER TANK POUCH

2880142-01 Black \$109.99

Felt lining, magnetic closure with three positions, sits on top of fuel tank for easy reach. Embossed Indian Motorcycle Branding. Fits model year 2016-2022.



GENUINE LEATHER FORK BAG

2879667-01 Black \$159.99

Attaches to motorcycle's forks. Mounting straps included. Pinnacle Concho required (2879674-266, -639, -640), sold separately. Driving Lights required (2880732-XXX or 2884470-266), sold separately. Fits model year 2016-2022.



GENUINE LEATHER TOOL ROLL INSERT

2880944-01 Black \$59.99
2880944-05 Desert Tan \$69.99

Assemble your own assortment of tools to keep prepared, stow them away in the pockets and folds within this quality leather Tool Roll Insert and store them in the Genuine Leather Fork Bag (2879667-01, -05), sold separately — a perfect fit for convenient storage. Fits model year 2016-2022.



RACK BAG

2881757-01 Black \$359.99

Includes mounting plates for the Solo Rack or Luggage Rack. Fits model year 2016-2022.



QUICK RELEASE

QUICK RELEASE KIT

2884045 \$159.99

Use this accessory to convert 2019-2022 standard hard or soft saddlebags or accessory Genuine Leather Saddlebags (2884005-02, -06), required, sold separately, to use Quick Release technology. Add or remove your saddlebags within seconds and without tools. Fender Strut Covers are also required and sold separately (5139598-156, -266 & 5139599-156, -266). Fits model year 2019-2022.



NEW

SPIRIT LAKE TOURING BAG

2889144-VBA Black \$369.99

Water-resistant vinyl bag with 6 storage pockets. Holds enough gear for one or two riders on a long-term trip. Includes branded rain cover. Recommended with Spirit Lake Rider Backrest Pad (2889299-VBA), sold separately. Fits model year 2014-2022.



NEW

SPIRIT LAKE DAY BAG

2889406-VBA Black \$199.99

Water-resistant vinyl bag with 6 storage pockets. Can be used on a bike or as a backpack or carry-on. Includes branded rain cover. Recommended with Spirit Lake Rider Backrest Pad (2889299-VBA), sold separately. Fits model year 2014-2022.



STRUT COVER & SPOOL KIT

2883998-156 Chrome \$309.99
2883998-266 Black \$309.99

Install to easily attach a Quick Release Passenger Sissy Bar or Genuine Leather Saddlebags, sold separately. Fits model year 2022 & 2014-2020 Chief Dark Horse.



NEW

SPIRIT LAKE RIDER BACKREST PAD

2889299-VBA Black \$99.99

Water-resistant vinyl. Attaches to the Spirit Lake Touring Bag (2889144-VBA) or Spirit Lake Day Bag (2889406-VBA), each sold separately, to create a comfortable rider backrest. Fits model year 2014-2022.



NEW

SPIRIT LAKE RACK BAG

2889145-VBA Black \$199.99

Water-resistant vinyl bag. Fits on Sissy Bar Luggage Rack (2880955-156, -266) or Trunk Rack (2884452-156, -266), each sold separately. Can also be mounted on passenger seat or on top of the Spirit Lake Touring Bag (2889144-VBA), sold separately. Includes branded rain cover. Fits model year 2014-2022.



2022

INTRO
2-11

FTR
12-27

SCOUT
28-51

INDIAN CHIEF
52-67

INDIAN SPRINGFIELD
68-91

CHIEFTAIN & ROADMASTER
92-121

INDIAN CHALLENGER
122-135

POWERBAND AUDIO
136-139

COLOR-MATCHED ACCESSORIES
140-143

GARAGE
144-151

eFTR
154-155



SPIRIT LAKE RACK BAG & PINNACLE SOLO LUGGAGE RACK

STORAGE & LUGGAGE - BUILD YOUR ACCESSORY TRUNK

Increase your storage and organize your possessions with simple-to-install trunk accessories. Each trunk has ample storage space, enough to hold two full-face helmets. These trunks feature exceptional color-matched paint options, extra comfort for a passenger and are the perfect addition to any ride.

STEP 1 - REQUIRED

QUICK RELEASE

QUICK RELEASE TRUNK BASE

2884048-156	Chrome	\$519.99
2884048-266	Black	\$519.99

Features Quick Release technology so riders can quickly remove their trunk without tools. Required for Quick Release Trunk. Mounts directly onto trunk to allow for trunk installation on bike. Made from steel with a chrome or black finish. Fits model year 2016-2022.



STEP 2 - REQUIRED

TRUNK INSTALLATION KIT

2884007	2019-2022 (shown)	\$159.99
2884008	2016-2018	\$159.99

Required for proper installation of an accessory Quick Release Trunk. Contains set of mounting spools and harnesses. Supplies electrical power to Quick Release Trunk. Fits model year 2016-2022.



STEP 2 - OPTIONAL

ADD POWERBAND AUDIO

See page 136 for details.

STEP 3 - REQUIRED

QUICK RELEASE

QUICK RELEASE TRUNK

2884046-XXX	\$929.99 - \$3,599.99
-------------	-----------------------

Visit the color-matched accessories section on page 140 for more information. Fits model year 2016-2022.



STEP 4 - REQUIRED

GENUINE LEATHER TRUNK BACKREST PAD

2880284-02	Black	\$359.99
2880284-06	Desert Tan	\$499.99
2881009-02	Black, Non-quilted	\$359.99
2881009-VBA	Rogue Black Vinyl	\$359.99
2884429-VBA	Black Vinyl*	\$359.99
2889056-VBA	Slim Black Vinyl	\$359.99

These backrests are recommended with coordinating accessory seats on page 80 or 2016-2022 standard seats. Fits model year 2016-2022.

*Compatible with ClimaCommand Classic Seat.



STEP 5 - OPTIONAL TRUNK ACCESSORIES

TOP SELLER

TRUNK ARMREST SUPPORT KITS & GENUINE LEATHER PASSENGER ARMREST PADS

2880041-01	Black	\$79.99
2880041-05	Desert Tan	\$109.99
2884428-VBA	Black Vinyl*	\$99.99
2880041-VBA	Rogue Black Vinyl	\$79.99
2880032-156	Armrest Support Kit - Chrome	\$349.99

Requires Quick Release Trunks (2884046-XXX). Fits model year 2016-2022.

See page 140 to choose your Quick Release Trunk color.

*Compatible with ClimaCommand Classic Seat.



NEW

TRUNK BIN LINER

2889606	\$119.99
---------	----------

Required to install Trunk Mounted Antenna (2889596), sold separately. Fits model year 2016-2022.



NEW

TRUNK MOUNTED ANTENNA

2889596	Black	\$249.99
---------	-------	----------

22 In. tall antenna mounts on right corner of trunk for enhanced radio reception. Requires Premium Trunk Liner (2889606), sold separately. Fits model year 2016-2022.



TRUNK RACK

2884452-156	Chrome	\$309.99
2884452-266	Gloss Black	\$309.99

Requires a Quick Release Trunk, Quick Release Trunk Base and Trunk Installation Kit, each sold separately. Fits model year 2016-2022.



RACK BAG

2881757-01	Black	\$359.99
------------	-------	----------

Includes mounting plates for the Solo Rack or Luggage Rack. Not compatible with Trunk Rack (2884452-156, -266). Fits model year 2016-2022.



DELUXE TRUNK TRAVEL BAG

2885132	Black	\$144.99
---------	-------	----------

Fits model year 2016-2022.



TRUNK ORGANIZER

2880298	Black	\$49.99
---------	-------	---------

Requires Quick Release Trunk (2884046-XXX), sold separately. Fits model year 2016-2022.



2022

INTRO
2-11

FTR
12-27

SCOUT
28-51

INDIAN CHIEF
52-67

INDIAN SPRINGFIELD
68-91

CHIEFTAIN &
ROADMASTER
92-121

INDIAN CHALLENGER
122-135

POWERBAND AUDIO
136-139

COLOR-MATCHED
ACCESSORIES
140-143

GARAGE
144-151

eFTR
154-155

SEATS & BACKRESTS



CLIMACOMMAND CLASSIC SEAT

2884419-VBA Black Vinyl \$999.99

Fits model year 2016-2022 without RIDE COMMAND. Harnesses may be required, see page 139.



CLIMACOMMAND ROGUE SEAT

2884558-VBA Black Vinyl \$1,199.99

Fits model year 2016-2022 without RIDE COMMAND. Harnesses may be required, see page 139. Recommended for models without Classic Saddlebag Lids.



ROGUE SEAT

2883663-VBA Black Vinyl \$449.99

Specially shaped cushioning. Integrates seats into stylish, single seat. Fits model year 2016-2022.



EXTENDED REACH ROGUE SEAT

2883664-VBA Black Vinyl \$449.99

Positions rider higher and 2 in. farther back than standard seat. Customized ergonomics for taller riders. Specially shaped cushioning. Integrates seats into stylish, single seat. Not compatible with rider backrest pads. Fits model year 2016-2022.



GENUINE LEATHER REDUCED REACH HEATED SEAT

2879578-02 Black \$619.99

Moves rider 1.5 in. forward. Fits model year 2016-2022 & 2014-2021 Vintage & Vintage Dark Horse.



GENUINE LEATHER HEATED SEAT

2880733-02 Black \$619.99

Fits model year 2016-2022 & 2014-2021 Vintage & Vintage Dark Horse.



GENUINE LEATHER TOURING HEATED SEAT

2882563-02 Black \$899.99

Does not work with Quick Release Passenger Sissy Bar. Fits model year 2016-2022 & 2014-2021 Vintage & Vintage Dark Horse.



GENUINE LEATHER EXTENDED REACH HEATED SEAT

2882423-02 Black w/ Studs \$899.99
2882423-06 Desert Tan w/ Studs \$1,029.99

Moves rider 2 in. back and 1 in. up. Moves passenger 1 in. up. Does not work with Genuine Leather Rider Backrest Pad. Fits model year 2016-2022 & 2014-2021 Vintage & Vintage Dark Horse.



TOP SELLER
PASSENGER SEAT

2880734-02 Heated Black w/ Studs* \$359.99
2880666 Black Vinyl w/ Studs** \$309.99
2882767-01 Black* \$309.99

*Genuine Leather. **Leather look all weather black vinyl. Recommended with Passenger Pegs (2880667-626), sold separately. Heated option requires Genuine Leather Reduced Reach Heated Seat (2879578-02, -06) or Genuine Leather Heated Seat (2880733-02, -06), each sold separately. Fits model year 2016-2022.



TOP SELLER
PASSENGER BACKREST PAD

2879666-01 Black* \$259.99
2879666-02 Black w/ Studs* \$209.99
2879666-06 Desert Tan w/ Studs* \$259.99
2879666-VBA Rogue Black Vinyl** \$259.99
2883728-VBA Black Vinyl** \$259.99

*Genuine Leather. **Leather look all weather black vinyl. Requires Quick Release Passenger Sissy Bar, sold separately. Fits model year 2016-2022.



TOP SELLER
SISSY BAR LUGGAGE RACK

2880955-156 Chrome \$259.99
2880955-266 Gloss Black \$259.99

Requires Quick Release Passenger Sissy Bar, sold separately. Fits model year 2016-2022.



LOW PROFILE PASSENGER PAD

2884620-VBA Black Vinyl* \$149.99
2884727-VBA Black Vinyl** \$149.99

Fits model year 2016-2022 & 2021 Vintage & Vintage Dark Horse. Only compatible with Low Profile Quick Release Passenger Sissy Bar (2884619-156, -266), sold separately. *Only compatible with the following Rogue Seats: 2883663-VBA (standard on 2019-2020 Indian Springfield Dark Horse) & 2883664-VBA. **Only compatible with the following Rogue Seat: 2884558-VBA.



TOP SELLER
GENUINE LEATHER RIDER BACKREST PAD

2879542-01 Black* \$389.99
2879542-02 Black w/ Studs* \$359.99
2879542-06 Desert Tan w/ Studs* \$389.99
2879542-VBA Rogue Black Vinyl** \$389.99
2879543 Backrest Mount (not shown) \$159.99

*Genuine Leather. **Leather look all weather black vinyl. Does not work with Genuine Leather Extended Reach Seat. Requires Rider Backrest Mount (2879543), sold separately. Fits model year 2016-2022.



QUICK RELEASE
LOW PROFILE QUICK RELEASE PASSENGER SISSY BAR

2884619-156 Chrome \$299.99
2884619-266 Gloss Black \$299.99

Fits model year 2016-2022 & 2021 Vintage & Vintage Dark Horse. Only compatible with Low Profile Passenger Pad (2884620-VBA, 2884727-VBA), sold separately.



2022

INTRO
2-11

FTR
12-27

SCOUT
28-51

INDIAN CHIEF
52-67

INDIAN SPRINGFIELD
68-91

CHIEFTAIN &
ROADMASTER
92-121

INDIAN CHALLENGER
122-135

POWERBAND AUDIO
136-139

COLOR-MATCHED
ACCESSORIES
140-143

GARAGE
144-151

eFTR
154-155



21 IN. QUICK RELEASE WINDSHIELD



A. 16 In. B. 16 In. C. 21 In. D. 14 In. E. 16 In.

QUICK RELEASE

QUICK RELEASE WINDSHIELDS & DEFLECTORS

- A. 2883309-266 16 In. Quick Release Wind Deflector - Tinted \$599.99
- B. 2880916 16 In. Quick Release Windshield - Clear \$699.99
- C. 2880915 21 In. Quick Release Windshield - Clear \$699.99

Indian Springfield Dark Horse requires the Top Mounted Spool Kit (2881476), sold separately. Fits 2016-2022 & 2020-2021 Vintage, Vintage Dark Horse & Chief Dark Horse. For 2016-2019 Chief windshields, search part numbers 2880725 and 2879574-02 on indianmotorcycle.com.

QUICK RELEASE

FLARE WINDSHIELD

- D. 2882221 14 In. Quick Release Flare Windshield - Tinted \$699.99
- E. 2883069-266 16 In. Quick Release Flare Windshield - Tinted \$599.99

Indian Springfield Dark Horse requires the Top Mounted Spool Kit (2881476), sold separately. Fits 2016-2022 & 2020-2021 Vintage, Vintage Dark Horse & Chief Dark Horse.

PICKING THE RIGHT WINDSHIELD

For riders looking for wind protection, a windshield that stops shortly below eye level will prevent you from looking through bug splatter, while directing air over your head.

For riders 5'6" and under, the 16 In. is recommended and the 21 In. is recommended for riders 6'2" and above.

MUSTACHE BAR SOFT CLOSEOUTS

2880941-01 Black \$159.99

Fits Mustache Highway Bar (standard on certain models). Made from vinyl for increased resistance to wear and tear from rocks, bugs and rain. Fits model year 2016-2022.



FRONT HIGHWAY BAR SOFT CLOSEOUTS

2881125 Black \$159.99

Requires Front Highway Bars (standard on certain models). Made from vinyl for increased resistance to wear and tear from rocks, bugs and rain. Fits model year 2016-2022.



FRONT HIGHWAY BAR

- 2884424-156 Chrome \$409.99
- 2884424-266 Gloss Black \$409.99

Fits model year 2016-2022.



MUSTACHE HIGHWAY BAR

- 2884425-156 Chrome \$409.99
- 2884425-266 Gloss Black \$409.99

Chrome is standard on Indian Springfield. Fits model year 2016-2022.



TOP SELLER

REAR HIGHWAY BARS

- 2879582-156 Chrome \$309.99
- 2879582-266 Gloss Black \$309.99

Chrome is standard on Indian Springfield. Fits model year 2016-2022.



FRONT FENDER BUMPER

- 2879551-156 Chrome \$209.99
- 2880750-266 Gloss Black \$204.99

Not compatible with Open Front Fender. Fits model year 2016-2022.



REAR FENDER BUMPER

- 2879550-156 Chrome \$159.99
- 2880751-266 Gloss Black \$154.99

Fits 2014-2021 Vintage & Vintage Dark Horse & 2021-2022 Indian Springfield.



PINNACLE SADDLEBAG PROTECTOR RAILS

2880917-156 Chrome \$409.99

Fits 2016-2022 Indian Springfield with Classic Saddlebags.



16. IN APE HANGER HANDLEBAR KIT



12 IN. APE HANGER HANDLEBAR KIT*

2884385-410	Polished Stainless	\$309.99
2884385-266	Gloss Black	\$309.99

Dealer Installation Recommended. Fits model year 2018-2022. Standard on 2020-2022 Indian Springfield Dark Horse.



16 IN. APE HANGER HANDLEBAR KIT*

2883449-266	Gloss Black**	\$359.99
2885137-410	Polished Stainless***	\$249.99
2885137-266	Gloss Black***	\$249.99

Dealer Installation Recommended. Fits model year 2018-2022. **Includes Extended Clutch Cable for 2014-2020 models, 2021 Vintage & Vintage Dark Horse & 2021-2022 Indian Springfield Dark Horse. ***Extended Clutch Cable not included, required, sold separately.



REDUCED REACH HANDLEBAR

2882919-410	Polished Stainless	\$209.99
-------------	--------------------	----------

Dealer Installation Recommended. Positions controls 2 in. closer. Fits model year 2018-2022.



BEACH BAR HANDLEBAR

2882921-410	Polished Stainless	\$209.99
2883448-266	Gloss Black	\$209.99

Dealer Installation Recommended. Fits model year 2018-2022.



CLUTCH CABLE INSTALLATION KIT

2885149	Springfield**	\$69.99
2885148	Springfield Dark Horse***	\$69.99

Fits 2021-2022 Indian Springfield. *Fits model year 2014-2020, 2021 Vintage & Vintage Dark Horse & 2021-2022 Indian Springfield Dark Horse.



HEATED HANDLEBAR GRIPS

2883268	Black	\$309.99
---------	-------	----------

Includes Wire Harness and Switch. Fits model year 2018-2022.



SELECT HANDLEBAR GRIPS

2882828-156	Chrome	\$179.99
2882828-468	Black	\$179.99

Fits model year 2018-2022.

SELECT RIDER FLOORBOARDS

2883021-156	Chrome	\$519.99
2883021-468	Black	\$519.99

Fits model year 2016-2022.

SELECT PASSENGER FLOORBOARDS

2882866-156	Chrome	\$409.99
2882866-468	Black	\$409.99

Fits model year 2016-2022.

SELECT TOE PEG

2880728-156	Chrome	\$79.99
2880728-468	Matte Black	\$79.99

Installs in place of the standard toe shifter peg and adds a great looking accessory to your Indian Motorcycle. Fits model year 2016-2022.

SELECT HEEL SHIFTER PEG

2880729-156	Chrome	\$49.99
2880729-468	Matte Black	\$49.99

Attaches to the Pinnacle Heel Shifter (2880103-156, -266, 2884772-156, -266), required sold separately. Fits model year 2016-2022.

INFINITE HIGHWAY PEGS

2879572-156	Chrome	\$309.99
2879572-266	Gloss Black	\$309.99

Fits model year 2016-2022.

PASSENGER PEGS

2880667-626	Matte Black	\$209.99
-------------	-------------	----------

Fits model year 2016-2022.

MUSTACHE HIGHWAY BAR FOOTREST

2880866	\$59.99
---------	---------

Mustache Highway Bar comes standard on Indian Springfield. Fits model year 2016-2022.



HEADDRESS RIDER FLOORBOARD PADS

2879606-01	Polished Inlays	\$209.99
------------	-----------------	----------

Use the Headdress Rider Floorboard Pads with your standard floorboards for an extra boost of style. Fits model year 2016-2022.



HEADDRESS PASSENGER FLOORBOARD PADS

2884155	\$199.99
---------	----------

Matches the Headdress Rider Floorboard Pads (2879606-01), sold separately. Add cushion to the floorboards and help isolate road vibration for a more comfortable ride. Installs easily over the Standard Passenger Floorboards (2880293), required, may be sold separately. Fits model year 2016-2022.



STANDARD PASSENGER FLOORBOARDS

2880293	Chrome Mount	\$199.99
2880288		\$109.99

Indian Springfield Dark Horse requires Adjustable Passenger Floorboard Mounts (2880288), sold separately. Standard on Indian Springfield. Fits model year 2016-2022.



SELECT SCRIPT PEGS

2880106-266	Gloss Black	\$159.99
-------------	-------------	----------

Can be installed on both the passenger pegs mount or highway bars peg mounts (see page 83 for highway bars options. Highway bars and passenger pegs, 2879993-156 or 2880667-626, sold separately). Requires Pinnacle Passenger Peg Supports (2879993-156) or Passenger Pegs (2880667-626), each sold separately. Fits model year 2016-2022.



PINNACLE HEEL SHIFTER

2880103-156	Chrome*	\$159.99
2880103-463	Black*	\$159.99
2884772-156	Chrome**	\$159.99
2884772-266	Black**	\$159.99

This heel shifter gives you the convenience and comfort of heel up-shifts and toe down-shifts. *Fits model year 2016-2020 Indian Springfield, 2018-2022 Indian Springfield Dark Horse & 2021 Vintage & Vintage Dark Horse. **Fits 2021-2022 Indian Springfield.



TOE RESTS

2881848-156	Chrome	\$179.99
-------------	--------	----------

Requires a highway bar, sold separately, see page 83. Fits model year 2016-2022.



2022

INTRO
2-11

FTR
12-27

SCOUT
28-51

INDIAN CHIEF
52-67

INDIAN SPRINGFIELD
68-91

CHIEFTAIN & ROADMASTER
92-121

INDIAN CHALLENGER
122-135

POWERBAND AUDIO
136-139

COLOR-MATCHED ACCESSORIES
140-143

GARAGE
144-151

eFTR
154-155

LIGHTING & ELECTRICAL

PATHFINDER ADAPTIVE LED HEADLIGHT

MONITORS LEAN ANGLE REAL-TIME TO DELIVER OPTIMIZED ILLUMINATION

15 INDIVIDUAL BEAMS
ACTIVATE AS NEEDED

OPTIMIZED LIGHTING IN BOTH
LOW-BEAM & HIGH-BEAM

REDUCES GLARE FROM ROAD AND
DIRECTS LIGHT WHERE YOU NEED IT



PATHFINDER ADAPTIVE LED HEADLIGHT

LOW BEAM

HIGH BEAM



628
LUMENS



793
LUMENS



1,213
LUMENS



1,316
LUMENS



0°

BIKE LEAN ANGLE



32°



0°

BIKE LEAN ANGLE



32°

PATHFINDER ADAPTIVE LED HEADLIGHT

2889459-156	Chrome	\$599.99
2889459-266	Black	\$599.99
2889636	Jumper*	\$29.99

Monitors bike's lean angle real-time to deliver optimized illumination. 15 individual beams activate as needed. Optimized lighting in both low-beam and high-beam. Reduces glare from road and directs light where you need it. Fits model year 2016-2022. *2016-2019 models require jumper (2889636), sold separately.



PATHFINDER LED DRIVING LIGHTS

2880875	\$309.99
---------	----------

Dealer installation required. 2014 models require software update. Fits model year 2016-2022.



TOP SELLER

PATHFINDER LED HEADLIGHT

2884422	\$409.99
---------	----------

Enhanced visibility with powerful, clean LED light. Branded with the Indian Motorcycle script, "I". Dealer installation required. Fits model year 2020-2022.



NEW

PATHFINDER AUXILIARY LED SADDLEBAG LIGHTS

2889224	\$179.99
---------	----------

Set of two. Add extra illumination and custom style. Lights install on rear face of each saddlebag. Plug-and-play connection. Not compatible with Classic Saddlebags. Fits model year 2019-2022.



PATHFINDER AUXILIARY LED SADDLEBAG LIGHTS



DRIVING LIGHTS

2884470-266	Gloss Black	\$399.99
2880732-463	Matte Black	\$289.99

Chrome Driving Lights are standard on 2016-2022 Indian Springfield. Change to gloss black for a custom look or to add Driving Lights to your Indian Springfield Dark Horse. Fits model year 2016-2022 & 2020-2021 Vintage & Chief Dark Horse.



RAM® BALL MOUNT

2880920	\$109.99
---------	----------

Fits on clutch perch. For RAM® Ball accessories visit the RAM® website. Fits model year 2016-2022.

WHEELS & SUSPENSION

19 IN. 10-SPOKE FRONT WHEEL

2883235-440	Contrast Cut	\$569.99
-------------	--------------	----------

Recommended with Open Front Fender (2882761-XXX), Front Tire, 130/60B/19 (5415817), each sold separately. Fits model year 2016-2022. Standard on 2018-2022 Indian Springfield Dark Horse.



LOWERING REAR SHOCK KIT BY FOX®

2884423	2020-2022	\$469.99
2883667	2016-2019	\$469.99

Creates the stylish, low-slung look of a custom-built bike. Lowers bike 1 in. and maintains outstanding rear suspension performance. Lowers the seat for comfortable, confidence-inspiring riding position. Air-adjustable mono-tube shock and steel coil spring deliver reliable damping and rebound. 2884423 fits model year 2020-2022 & 2020-2021 Vintage & Chief Dark Horse. Standard on 2020-2022 Indian Springfield Dark Horse. 2883667 fits model year 2016-2019.



2022

INTRO
2-11

FTR
12-27

SCOUT
28-51

INDIAN CHIEF
52-67

INDIAN SPRINGFIELD
68-91

CHIEFTAIN &
ROADMASTER
92-121

INDIAN CHALLENGER
122-135

POWERBAND AUDIO
136-139

COLOR-MATCHED
ACCESSORIES
140-143

GARAGE
144-151

eFTR
154-155

CRAFTED STYLE PIECES

HEADRESS FENDER EMBLEM

2883668-156 Chrome \$109.99
2883668-266 Black \$109.99



Evokes classic Indian Motorcycle style and adds a custom look. Durable, die-cast emblem is engineered specifically for Open Front Fender. Proportions are perfect for this fender and emblem installs securely. Can also be installed on a tool box or in a rider cave. Fits model year 2016-2022 & 2020-2021 Vintage & Chief Dark Horse.

INDIAN SCRIPT LICENSE PLATE FRAME

2882863-156 Chrome \$89.99



Check local laws as the frame may cover license plate information. Fits model year 2016-2022.

DISCONTINUED

PINNACLE FENDER TIP ACCENTS

2879646-156 Chrome \$149.99



Fits 2016-2022 models with Valanced Front Fender. *Only available while supplies last.

BEIGE DIAL FACE FUEL GAUGE

2880731-156 Chrome \$209.99
2880731-266 Gloss Black \$209.99



Fits model year 2016-2022.

TOP SELLER

REDUCED REACH SIDE STAND

2881771-156 Chrome \$189.99
2881771-463 Matte Black \$189.99

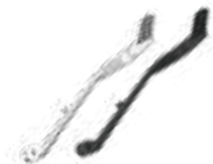

Allows shorter riders to reach the side stand while on the bike. Fits model year 2016-2022.

TOP SELLER

PINNACLE MIRRORS

2880132-156 Chrome \$199.99



These mirrors feature a dynamic, laterally tapered design and have Indian Motorcycle script branding on the backsides. They are supported by forged arms for added strength and style. These mirrors directly replace the standard mirrors and provide outstanding visibility. Includes left and right-hand mirrors. Fits model year 2016-2022.

TOP SELLER

PINNACLE SEAT BOLT COVER

2880141-156 Chrome \$49.99



This chrome bracket covers the rear seat mounting bolt and has a chromed, knurled screw that prominently features Indian Motorcycle branding. Fits model year 2016-2022.

HEADRESS LICENSE PLATE FRAME

2882864-156 Chrome \$89.99



Check local laws as the frame may cover license plate information. Fits model year 2016-2022.

DISCONTINUED

PINNACLE SOLO RIDER GRAB RAIL

2879604-156 Chrome \$259.99
2880752-266 Gloss Black \$259.99



Not compatible with Touring Seats or Rogue Seats. Fits model year 2016-2022. *Only available while supplies last.

SADDLEBAG TRIM

2881769 Black \$69.99



Fits 2016-2022 models with a Valanced Front Fender.

DISCONTINUED

CLUTCH LIFTER ARM

2879992-156 Chrome \$49.99



Replaces standard clutch lifter arm. No additional hardware required. Fits 2016-2022 models with a Valanced Front Fender. *Only available while supplies last.

BLACK MIRRORS

2881013-463 Black \$129.99



These Black Mirrors greatly enhance the style of your motorcycle by helping to complete the blacked-out styling. These mirrors directly replace the standard mirrors and provide outstanding visibility. Fits model year 2016-2022.

OPEN FRONT FENDER

2882761-XXX \$309.99 - \$799.99



Recommended with 19 in. 10-Spoke Front Wheel (2883235-266, -440) or Precision Machined Front Wheel (2884426-266W), each sold separately. Visit the color-matched accessories section on page 140 for more information. Fits model year 2016-2022.

BACKREST PLUGS

2881788 \$19.99



Fits into open tubes of Quick Release Passenger Sissy Bar required, sold separately, for a clean, finished custom look. Fits model year 2016-2022.

CRUISER ENGINE COVER KIT

A. 2883322-09 Steel Gray \$129.99
B. 2883322-10 Ivory Cream \$129.99
C. 2883322-11 Gloss Pearl White \$149.99
D. 2883322-12 Star Silver \$129.99
E. 2883322-13 Thunder Black Pearl \$149.99

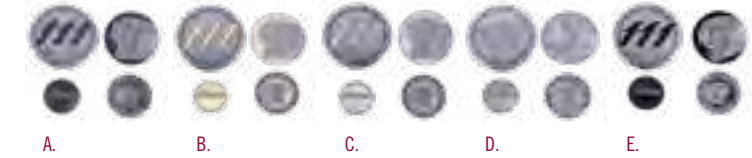

Clock-wise beginning top-left, this kit includes an Air Box Cover, Primary Cover, Horn Cover and Cam Cover. These components install in place of the standard covers and give the bike colorful and coordinated custom style. Fits model year 2016-2022.

DISCONTINUED

PINNACLE PRIMARY COVER

2879563-156 Chrome \$49.99



Fits model year 2016-2022. *Only available while supplies last.

DISCONTINUED

PINNACLE CAM COVER

2879564-156 Chrome \$49.99



Fits model year 2016-2022. *Only available while supplies last.

BLACK DIAL FACE SPEEDOMETER

2883444 Black \$209.99



This speedometer combines classic Indian Motorcycle branding and a distinctive, black dial face for an iconic look every ride. Dealer installation required. Fits model year 2016-2022. Standard on Indian Springfield Dark Horse. 2019 and newer models require a software update and are dealer installation only.

BLACK DIAL FACE FUEL GAUGE

2883445-266 Black \$209.99



This gauge combines classic Indian Motorcycle branding and a distinctive, black dial face for an iconic look every ride. Dealer installation required. Fits model year 2016-2022. Standard on Indian Springfield Dark Horse. 2019 and newer models may require a software update and are dealer installation only.

NEW

LOCKING FUEL CAP

2884600-156 Chrome \$79.99
2884600-266 Black \$79.99



Includes one locking fuel cap, two keys and installation instructions. Fits model year 2022.



2022

INTRO
2-11

FTR
12-27

SCOUT
28-51

INDIAN CHIEF
52-67

INDIAN SPRINGFIELD
68-91

CHIEFTAIN &
ROADMASTER
92-121

INDIAN CHALLENGER
122-135

POWERBAND AUDIO
136-139

COLOR-MATCHED
ACCESSORIES
140-143

GARAGE
144-151

eFTR
154-155

CRAFTED STYLE PIECES

GENUINE LEATHER FULL MUSTACHE HIGHWAY BAR WRAPS

2880942-01	Black	\$209.99
2880942-05	Desert Tan	\$219.99

Fits model year 2016-2022 if equipped with a Mustache Highway Bar. Models without a Mustache Highway Bar will require 2884425-156, -266, sold separately.



DISCONTINUED

GENUINE LEATHER REAR MUD FLAP

2880009-05	Desert Tan (shown)	\$89.99
2879584-05	Desert Tan w/ Fringe	\$89.99

Fits 2016-2022 Indian Springfield, 2018-2019 Indian Springfield Dark Horse & 2014-2021 Vintage, Vintage Dark Horse & Chief Dark Horse. *Only available while supplies last.



GENUINE LEATHER FLOORBOARD TRIM

2880007-01	Black (shown)	\$199.99
2880007-05	Desert Tan	\$209.99
2880007-06	Desert Tan w/ Studs (shown)	\$229.99

Fits model year 2016-2022 & 2014-2021 Vintage & Chief Dark Horse.



GENUINE LEATHER PARTIAL MUSTACHE HIGHWAY BAR WRAPS

2880943-01	Black	\$159.99
2880943-05	Desert Tan	\$169.99

Fits model year 2016-2022 if equipped with a Mustache Highway Bar. Models without a Mustache Highway Bar will require 2884425-156, -266, sold separately.



GENUINE LEATHER GRIP WRAPS

2879999-01	Black (shown)	\$59.99
2879999-05	Desert Tan	\$69.99

Fits model year 2016-2022.



16 IN. APE HANGER HANDLEBAR



2022

INTRO
2-11

FTR
12-27

SCOUT
28-51

INDIAN CHIEF
52-67

INDIAN SPRINGFIELD
68-91

CHIEFTAIN & ROADMASTER
92-121

INDIAN CHALLENGER
122-135

POWERBAND AUDIO
136-139

COLOR-MATCHED ACCESSORIES
140-143

GARAGE
144-151

eFTR
154-155



ACCESSORIES FEATURED

1. Stage 1 Oval Slip-On Muffler Kit, Pg. 102
2. Thunderstroke Stage 1 Performance Air Intake, Pg. 102
3. 13.7 In. Flare Windshield, Pg. 112
& Pathfinder Adaptive LED Headlight, Pg. 116
4. PowerBand Audio Plus, Pg. 136
& Mid Rise Handlebar, Pg. 114
5. Low Profile Quick Release Passenger Sissy Bar &
Low Profile Backrest Pad, Pg. 111



ACCESSORIES FEATURED

1. Locking Fuel Cap, Pg. 119
2. Spirit Lake Rack Bag, Pg. 107
3. Spirit Lake Touring Bag & Spirit Lake Rider Backrest Pad, Pg. 107
4. PowerBand Audio Plus, Pg. 136
5. Stage 1 Oval Slip-On Muffler Kit, Pg. 102
6. Pathfinder Auxiliary LED Saddlebag Lights, Pg. 117





ACCESSORIES FEATURED

1. Genuine Leather Trunk Backrest Pad, Pg. 108
Genuine Leather Passenger Armrest Pads, Pg. 109
Genuine Leather Rider Backrest Pad, Pg. 111
2. Trunk Organizer, Pg. 109
3. Saddlebag Lid Racks, Pg. 106
4. Thunderstroke High Flow Air Intake, Pg. 102
5. Pinnacle Mirrors, Pg. 118
6. Thunderstroke Stage 1 Slip-On Exhaust Kit, Pg. 102
& Fish Tail Exhaust Tips, Pg. 104





ACCESSORIES FEATURED

1. Mid Rise Handlebar, Pg. 114 & PowerBand Audio, Pg. 136
2. Stage 1 Oval Slip-On Muffler Kit, Pg. 102
3. Thunderstroke Stage 1 Performance Air Intake, Pg. 102
4. 13 In. Flare Windscreen, Pg. 112
5. ClimaCommand Rogue Seat, Pg. 110



ACCESSORIES FEATURED

1. Stage 1 Oval Slip-On Muffler Kit, Pg. 102
2. 13.7 In. Flare Windshield, Pg. 112
3. Pathfinder Adaptive LED Headlight & Pathfinder S LED Driving Lights, Pg. 116
4. PowerBand Audio - Saddlebag Speakers, Pg. 136
5. PowerBand Audio - Front Fairing, Pg. 136



ENGINE PERFORMANCE



TOP SELLER
STAGE 1 OVAL SLIP-ON MUFFLER KIT

2884187-156 Δ Chrome \$999.99
2884187-266 Δ Black \$999.99

Δ See legal disclaimer at bottom of right page. Fits model year 2014-2022.



TOP SELLER
THUNDERSTROKE STAGE 1 SLIP-ON EXHAUST KIT

2879769-156 Δ Chrome \$699.99
2879769-266 Δ Matte Black \$699.99

Δ See legal disclaimer at bottom of right page. Requires exhaust tips, sold separately. Fits model year 2014-2022.



TOP SELLER
THUNDERSTROKE HIGH FLOW AIR INTAKE

2880654-156 Δ Chrome \$519.99
2880654-266 Δ Gloss Black \$519.99

Δ See legal disclaimer at bottom of right page. Dealer installation required. Fits model year 2014-2022.



TOP SELLER
THUNDERSTROKE STAGE 1 PERFORMANCE AIR INTAKE

2881779-156 Δ Chrome \$519.99
2881779-521 Δ Matte Black \$519.99

Δ See legal disclaimer at bottom of right page. Fits model year 2014-2022.



THUNDERSTROKE FORWARD STAGE 1 AIR INTAKE

2884950-156 Δ Chrome \$549.99
2884950-266 Δ Gloss Black \$549.99

Add high-performance style and provide proper airflow with this Thunderstroke Forward Stage 1 Air Intake. This air intake makes it clear that your bike is way beyond stock and is worth noticing. This is an ideal Air Intake to use with the Stage 1 Slip-On Exhaust. Dealer installation required for recalibration to ensure peak performance. Δ See legal disclaimer at bottom of right page. Fits model year 2014-2022.



TOP SELLER
THUNDERSTROKE STAGE 2 PERFORMANCE KIT

2884323 Δ \$799.99

Requires an Indian Motorcycle Stage 1 Muffler or Exhaust Kit and an Indian Motorcycle Stage 1 Air Intake, each sold separately. Δ See legal disclaimer at bottom of page. Fits 2020-2022 Thunderstroke 116 models: Chieftain, Chieftain Limited, Chieftain Dark Horse, Roadmaster & Roadmaster Dark Horse.



TOP SELLER
THUNDERSTROKE STAGE 2 PERFORMANCE CAMS

2881676 Δ \$569.99

Requires an Indian Motorcycle Stage 1 Muffler or Exhaust Kit and an Indian Motorcycle Stage 1 Air Intake, each sold separately. Increases horsepower by 13% and torque by 7% over the standard engine configuration. Δ See legal disclaimer at bottom of page. Dealer installation required. Fits model year 2014-2022.

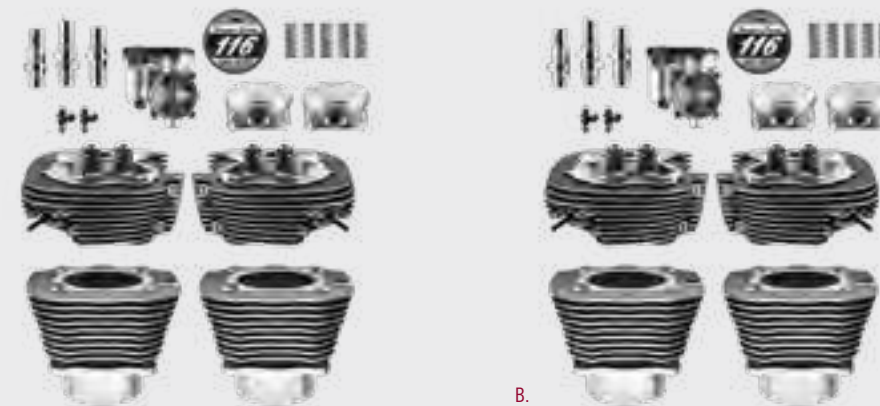

THUNDERSTROKE 116 CI STAGE 3 BIG BORE KIT

A. 2884322 Δ 2020-2022 \$2,999.99
B. 2883921 Δ 2019-2020 \$2,749.99
C. 2884062 Δ 2014-2018 (not shown) \$2,749.99

The Thunderstroke 116 ci Stage 3 Big Bore Kit will transform your Thunderstroke 111 into a powerhouse by delivering 20% more horsepower than a standard Thunderstroke 111 engine configuration. This kit also requires the Stage 1 Oval Slip-On Muffler Kit, or the Thunderstroke Stage 1 Slip-On Exhaust Kit as well as the Thunderstroke Stage 1 Performance Air Intake or Thunderstroke High Flow Air Intake, each sold separately. Δ See legal disclaimer at bottom of page. Fits model year 2014-2022.

Δ This kit meets EPA and CARB emission limits. Non-competition street use on motorcycles subject to USEPA noise limits & may violate federal noise limits. Please see inside back cover for further information.

Δ This kit meets EPA emission limits. Not legal for sale or use on non-competition pollution controlled vehicles in California. Tampering with emission-related parts can lead to substantial regulatory penalties. Non-competition street use may violate federal noise limits.

Performance parts are 50 state emissions compliant. Non-competition street use on motorcycles subject to USEPA noise limits & may violate federal noise limits. Indian Motorcycle recognizes the importance of environmental laws that regulate exhaust and noise emissions and is committed to developing performance parts that allow motorcycle enthusiasts to modify their vehicles in a safe and responsible manner. Emissions / Safety: Federal and many state laws prohibit the removal, modification, or rendering inoperative any part installed on motor vehicles by Indian Motorcycle affecting emissions or safety on motor vehicles manufactured for use on a public street or highway. Violation may result in fines. International markets, please consult your local laws for additional information. Noise: Certain Indian Motorcycle performance parts are subject to noise-related usage restrictions. The warning statement for these parts includes the statement, "On road use of this product may violate federal law." These products are designed for use on closed course motorcycles only and do not conform to U.S. EPA noise emission standards. Use on motorcycles subject to EPA noise regulations constitutes tampering and is a violation of Federal law unless it can be shown that such use does not cause the motorcycle to exceed applicable Federal Standards.

Compliant with SAE® J2825 standard. Does not void factory warranty. This complete kit conveniently includes the required Calibration Code that upgrades the Engine Control Module (ECM) software from standard to Stage 1, allowing this kit to be properly installed by your dealer. No additional software purchase necessary. Each kit is designated with a warning triangle to indicate the restrictions that may apply.



2022

INTRO
2-11

FTR
12-27

SCOUT
28-51

INDIAN CHIEF
52-67

INDIAN SPRINGFIELD
68-91

CHIEFTAIN &
ROADMASTER
92-121

INDIAN CHALLENGER
122-135

POWERBAND AUDIO
136-139

COLOR-MATCHED
ACCESSORIES
140-143

GARAGE
144-151

eFTR
154-155

ENGINE PERFORMANCE



STRAIGHT EXHAUST TIPS

2880671-156	Chrome	\$259.99
2880671-266	Matte Black	\$259.99

Machined billet aluminum with the largest inner-diameter giving these straight tips the deepest sound. Requires Stage 1 Exhaust (2879769-156, -266), sold separately. Fits model year 2014-2022.



FISH TAIL EXHAUST TIPS

2879532-156	Chrome	\$209.99
2879532-266	Matte Black	\$209.99

Stamped steel and classic styling. Requires Stage 1 Exhaust (2879769-156, -266), sold separately. Fits model year 2014-2022.

TOP SELLER



SIX SHOOTER EXHAUST TIPS

2879530-156	Chrome	\$309.99
2879530-266	Matte Black	\$309.99

Choose between 4 different mounting screw hole locations to position the exhaust tips to suit your style. Requires Stage 1 Exhaust (2879769-156, -266), sold separately. Fits model year 2014-2022.



GROOVED EXHAUST TIPS

2880799-156	Chrome	\$309.99
2880799-266	Matte Black	\$309.99

Most visible from the road. Made of billet aluminum. Requires Stage 1 Exhaust (2879769-156, -266), sold separately. Fits model year 2014-2022.



THUNDERSTROKE PERFORMANCE CLUTCH KIT

2883957	\$309.99
---------	----------

This Performance Clutch Kit enhances clutch durability and reliability on a bike equipped with Indian Motorcycle high-performance stage kits. Fits model year 2014-2020.



EXHAUST SHIELDS

2883245	Matte Black*	\$279.99
2885129	Matte Black**	\$279.99

Steel with a matte black finish. Direct replacement for existing heat shields. *Fits model year 2014-2020. Standard on 2019-2020 Chieftain Dark Horse. **Fits model year 2021-2022.



2022

INTRO
2-11

FTR
12-27

SCOUT
28-51

INDIAN CHIEF
52-67

INDIAN SPRINGFIELD
68-91

CHIEFTAIN &
ROADMASTER
92-121

INDIAN CHALLENGER
122-135

POWERBAND AUDIO
136-139

COLOR-MATCHED
ACCESSORIES
140-143

GARAGE
144-151

eFTR
154-155

THUNDERSTROKE STAGE 1 PERFORMANCE AIR INTAKE

FULL ACCESSORY DETAILS AVAILABLE AT [INDIANMOTORCYCLE.COM/ACCESSORIES](https://www.IndianMotorcycle.com/accessories)

STORAGE & LUGGAGE

SADDLEBAG LID RACKS

2883402-156 Chrome \$359.99
Fits model year 2014-2018 & 2019-2022 Chieftain Classic.



GENUINE LEATHER TOOL ROLL INSERT

2880944-01 Black \$59.99
2880944-05 Desert Tan \$69.99



Assemble your own assortment of tools to keep prepared, stow them away in the pockets — a perfect fit for convenient storage. Fits model year 2014-2022.



RACK BAG

2881757-01 Black \$359.99

Includes mounting plates for the Solo Rack or Luggage Rack. Not compatible with Trunk Rack (2884452-156, -266). Fits model year 2014-2022.



DELUXE TRUNK TRAVEL BAG

2885132 Black \$144.99

Quick Release Trunk (2884046-XXX), required sold separately. Fits model year 2014-2022.



HARD LOWER FAIRINGS LOCK KIT

2881170 \$49.99

Fits model year 2015-2022.



TOP SELLER

PINNACLE SOLO LUGGAGE RACK

2885004-156 Chrome \$309.99
2885004-266 Gloss Black \$309.99

Fits 2014-2022 Chieftain models.



TOP SELLER

GENUINE LEATHER TANK POUCH

2880142-01 Black \$109.99

Felt lining, magnetic closure with three positions, sits on top of fuel tank for easy reach. Embossed Indian Motorcycle Branding. Fits model year 2014-2022.



GENUINE LEATHER REAR HIGHWAY BAR BAG

2880297-01 Black \$209.99
2880297-05 Desert Tan \$229.99

Velcro® strips hold lid closed. Detachable genuine leather water bottle holder attaches to the left Rear Highway Bars (2879582-156, -266), required, sold separately. Fits model year 2014-2022.



TOP SELLER

DELUXE SADDLEBAG TRAVEL BAGS

2885131 Black \$154.99

Set of two. Fits model year 2014-2022.



QUICK RELEASE

QUICK RELEASE KIT

2884045 \$159.99

Use this accessory to convert 2019-2022 saddlebags to have Quick Release technology. Add or remove your saddlebags within seconds and without tools. Fits model year 2019-2022. Standard on 2014-2018.



NEW

SPIRIT LAKE TOURING BAG

2889144-VBA Black \$369.99

Water-resistant vinyl bag with 6 storage pockets. Holds enough gear for one or two riders on a long-term trip. Includes branded rain cover. Recommended with Spirit Lake Rider Backrest Pad (2889299-VBA), sold separately. Fits model year 2014-2022.



NEW

SPIRIT LAKE DAY BAG

2889406-VBA Black \$199.99

Water-resistant vinyl bag with 6 storage pockets. Can be used on a bike or as a backpack or carry-on. Includes branded rain cover. Recommended with Spirit Lake Rider Backrest Pad (2889299-VBA), sold separately. Fits model year 2014-2022.



NEW

SPIRIT LAKE RIDER BACKREST PAD

2889299-VBA Black Vinyl \$99.99

Water-resistant vinyl. Attaches to the Spirit Lake Touring Bag (2889144-VBA) or Spirit Lake Day Bag (2889406-VBA), each sold separately, to create a comfortable rider backrest. Fits model year 2014-2022.



NEW

SPIRIT LAKE RACK BAG

2889145-VBA Black \$199.99

Water-resistant vinyl bag. Fits on Sissy Bar Luggage Rack (2880955-156, -266) or Trunk Rack (2884452-156, -266), each sold separately. Can also be mounted on passenger seat or on top of the Spirit Lake Touring Bag (2889144-VBA), sold separately. Includes branded rain cover. Fits model year 2014-2022.



SPIRIT LAKE TOURING BAG

FULL ACCESSORY DETAILS AVAILABLE AT INDIANMOTORCYCLE.COM/ACCESSORIES



2022

INTRO
2-11

FTR
12-27

SCOUT
28-51

INDIAN CHIEF
52-67

INDIAN SPRINGFIELD
68-91

CHIEFTAIN &
ROADMASTER
92-121

INDIAN CHALLENGER
122-135

POWERBAND AUDIO
136-139

COLOR-MATCHED
ACCESSORIES
140-143

GARAGE
144-151

eFTR
154-155

STORAGE & LUGGAGE - BUILD YOUR ACCESSORY TRUNK

Increase your storage and organize your possessions with simple-to-install trunk accessories. Each trunk has ample storage space, enough to hold two full-face helmets. These trunks feature exceptional color-matched paint options, extra comfort for a passenger and are the perfect addition to any ride.

STEP 1 - REQUIRED

QUICK RELEASE

QUICK RELEASE TRUNK BASE

2884048-156	Chrome	\$519.99
2884048-266	Black	\$519.99

Features Quick Release technology so riders can quickly remove their trunk without tools. Required for Quick Release Trunk (2884046-XXX). Mounts directly onto trunk to allow for trunk installation on bike. Made from steel with a chrome or black finish. Fits model year 2014-2022.



STEP 2 - REQUIRED

TRUNK INSTALLATION KIT

2884007	2019-2022 (shown)	\$159.99
2884008	2016-2018	\$159.99

Required for proper installation of an accessory Quick Release Trunk. Contains set of mounting spools and harnesses. Supplies electrical power to Quick Release Trunk. Fits 2014-2022 Chieftain models. Dealer installation recommended.



STEP 2 - OPTIONAL

ADD POWERBAND AUDIO

See page 136 for details.

STEP 3 - REQUIRED

QUICK RELEASE

QUICK RELEASE TRUNK

2884046-XXX	\$929.99 - \$3,599.99
-------------	-----------------------

Visit the color-matched accessories section on page 140 for more information. Fits model year 2014-2022.



STEP 4 - REQUIRED

GENUINE LEATHER TRUNK BACKREST PAD

2880284-02	Black	\$359.99
2880284-06	Desert Tan	\$499.99
2881009-02	Black, Non-Quilted	\$359.99
2881009-VBA	Rogue Black Vinyl	\$359.99
2884429-VBA	Black Vinyl*	\$359.99
2889056-VBB	Black Vinyl	\$359.99

These backrests are recommended with coordinating accessory seats on page 110. Fits model year 2014-2022. *Compatible with ClimaCommand Classic Seat.



NEW



QUICK RELEASE TRUNK & TRUNK BACKREST PAD

CHIEFTAIN MODELS & ROADMASTER MODELS

STEP 5 - OPTIONAL TRUNK ACCESSORIES

TOP SELLER

TRUNK ARMREST SUPPORT KITS & GENUINE LEATHER PASSENGER ARMREST PADS

2880041-01	Black	\$79.99
2880041-05	Desert Tan	\$109.99
2884428-VBA	Black Vinyl**	\$99.99
2880041-VBA	Rogue Black Vinyl	\$79.99
2880032-156	Armrest Support Kit - Chrome*	\$349.99

Requires Quick Release Trunks (2884046-XXX) and Armrest Support Kit, each sold separately. Fits model year 2014-2022.

*Only works with Quick Release Trunks (2884046-XXX). **Compatible with ClimaCommand Classic Seat.



NEW

PREMIUM TRUNK LINER

2889606	\$119.99
---------	----------

Required to install Trunk Mounted Antenna (2889596), sold separately. Fits model year 2015-2022.



NEW

TRUNK MOUNTED ANTENNA

2889596	Black	\$249.99
---------	-------	----------

22 In. tall antenna mounts on right corner of trunk for enhanced radio reception. Requires Premium Trunk Liner (2889606), sold separately. Fits model year 2015-2022.



TRUNK RACK

2884452-156	Chrome	\$309.99
2884452-266	Gloss Black	\$309.99

Fits model year 2014-2022. Standard on 2020-2022 Roadmaster.



TRUNK ORGANIZER

2880298	Black	\$49.99
---------	-------	---------

Requires Quick Release Trunk (2884046-XXX), sold separately. Fits model year 2014-2022.



2022

INTRO
2-11

FTR
12-27

SCOUT
28-51

INDIAN CHIEF
52-67

INDIAN SPRINGFIELD
68-91

CHIEFTAIN & ROADMASTER
92-121

INDIAN CHALLENGER
122-135

POWERBAND AUDIO
136-139

COLOR-MATCHED ACCESSORIES
140-143

GARAGE
144-151

eFTR
154-155

SEATS & BACKRESTS



CLIMACOMMAND CLASSIC SEAT

2884559-VBA Black Vinyl* \$1,199.99
2884419-VBA Black Vinyl** \$999.99



CLIMACOMMAND ROGUE SEAT

2884558-VBA Black Vinyl \$1,199.99



Fits model year 2014-2022. Compatible with RIDE COMMAND on 2020-2022 models. Harnesses may be required, see page 139. Recommended for models without Classic Saddlebag Lids.

*Fits model year 2014-2022. Compatible with RIDE COMMAND on 2020-2022 models.
**Fits 2014-2019 models & 2020-2022 models without RIDE COMMAND. Harnesses may be required, see page 139.

ROGUE SEAT

2883663-VBA Black Vinyl \$449.99



Specially shaped cushioning. Integrates seats into stylish, single seat. Fits model year 2014-2022. Standard on 2019 Chieftain.

EXTENDED REACH ROGUE SEAT

2883664-VBA Black Vinyl \$449.99



Positions rider higher and 2 in. farther back than standard seat. Customized ergonomics for taller riders. Specially shaped cushioning. Integrates seats into stylish, single seat. Not compatible with rider backrest pads. Fits model year 2014-2022.

GENUINE LEATHER REDUCED REACH HEATED SEAT

2879578-02 Black \$619.99



Chieftain models requires Heated Seat Harness (2415036), sold separately. Fits model year 2014-2022.

GENUINE LEATHER HEATED SEAT

2880733-02 Black \$619.99



Chieftain models requires Heated Seat Harness (2415036), sold separately. Fits model year 2014-2022.

GENUINE LEATHER TOURING HEATED SEAT

2882563-02 Black \$899.99



Chieftain models requires Heated Seat Harness (2415036), sold separately. Works with Quick Release Passenger Sissy Bar. Fits model year 2014-2022. Stock on Roadmaster.

GENUINE LEATHER EXTENDED REACH HEATED SEAT

2882423-02 Black w/ Studs \$899.99
2882423-06 Desert Tan w/ Studs \$1,029.99



Chieftain models requires Heated Seat Harness (2415036), sold separately. Does not work with Genuine Leather Rider Backrest Pad. Fits model year 2014-2022.

TOP SELLER PASSENGER SEAT

2880734-02 Heated Black w/ Studs* \$359.99
2880666 Black Vinyl w/ Studs** \$309.99
2882767-01 Black* \$309.99



*Genuine Leather. **Leather look all weather black vinyl. Recommended with Passenger Pegs (2880667-626), sold separately. Heated option requires Genuine Leather Reduced Reach Heated Seat (2879578-02, -06) or Genuine Leather Heated Seat (2880733-02, -06), each sold separately. Fits 2014-2022 Chieftain models.

TOP SELLER SISSY BAR LUGGAGE RACK

2880955-156 Chrome \$259.99
2880955-266 Gloss Black \$259.99



Requires Quick Release Passenger Sissy Bar, sold separately. Fits 2014-2022 Chieftain models.



TOP SELLER PASSENGER BACKREST PAD

2879666-01 Black* \$259.99
2879666-02 Black w/ Studs* \$209.99
2879666-06 Desert Tan w/ Studs* \$259.99
2879666-VBA Rogue Black Vinyl** \$259.99

*Genuine Leather. **Leather look all weather black vinyl. Requires Quick Release Passenger Sissy Bar, sold separately. Fits 2014-2022 Chieftain models.



LOW PROFILE PASSENGER PAD

2884620-VBA Black Vinyl* \$149.99
2884727-VBA Black Vinyl** \$149.99

Only compatible with Low Profile Quick Release Passenger Sissy Bar (2884619-156, -266), sold separately. Fits model year 2014-2022.
*Compatible with the following Rogue Seats: 2883663-VBA (standard on 2019-2022 Chieftain, Chieftain Dark Horse & Chieftain Limited) & 2883664-VBA.
**Compatible with the following Rogue Seat: 2884558-VBA.



TOP SELLER QUICK RELEASE UNIVERSAL PASSENGER SISSY BAR

2884186-156 12 In. Chrome \$469.99
2884186-266 12 In. Gloss Black \$449.99

Requires Passenger Backrest Pad (2883728-VBA), sold separately. Backrest Plugs (2881788), sold separately fit into the open tubes of the Quick Release Universal Passenger Sissy Bar, for a clean finished custom look. Fits model year 2014-2022.



TOP SELLER GENUINE LEATHER RIDER BACKREST PAD

2879542-01 Black \$389.99
2879542-02 Black w/ Studs \$359.99
2879542-06 Desert Tan w/ Studs \$389.99
2879543 Backrest Mount (not shown) \$159.99

Does not work with Genuine Leather Extended Reach Seat. Fits model year 2014-2022.



QUICK RELEASE LOW PROFILE QUICK RELEASE PASSENGER SISSY BAR

2884619-156 Chrome \$299.99
2884619-266 Gloss Black \$299.99

Only compatible with Low Profile Passenger Pad (2884620-VBA, 2884727-VBA), sold separately. Fits model year 2014-2022.



QUICK RELEASE PASSENGER SISSY BAR

2880833-266 14 In. Tall Gloss Black \$449.99

Requires Passenger Backrest Pad (2879666-XX or 2883728-VBA), each sold separately. Fits model year 2014-2022. In order to fit Roadmaster, removal of the Quick Release Trunk & Trunk Base is required.



2022

INTRO
2-11

FTR
12-27

SCOUT
28-51

INDIAN CHIEF
52-67

INDIAN SPRINGFIELD
68-91

CHIEFTAIN &
ROADMASTER
92-121

INDIAN CHALLENGER
122-135

POWERBAND AUDIO
136-139

COLOR-MATCHED
ACCESSORIES
140-143

GARAGE
144-151

eFTR
154-155

PROTECTION



11.3 IN. WINDSCREEN



11.3 In.

11.3 IN. WINDSCREEN

2881124-01	Clear	\$169.99
2881124-02	Tinted	\$179.99

11.3 In. tall. Fits model year 2014-2022.



13.7 In.

TOP SELLER

13.7 IN. FLARE WINDSHIELD

2880222-01	Clear	\$209.99
2880222-02	Tinted	\$229.99

13.7 In. tall. Fits model year 2014-2022.



13.9 In.

13.9 IN. LOW PRO WINDSHIELD

2881800-02	Tinted	\$189.99
------------	--------	----------

13.9 In. tall. (4 In. lower than standard 2014-2015 Chieftain windshield.) Fits model year 2014-2022.



21 In.

21 IN. TOURING WINDSHIELD

2881799	Clear	\$239.99
---------	-------	----------

21 In. tall. (4 In. higher than stock Roadmaster.) Fits model year 2014-2022.

PICKING THE RIGHT WINDSHIELD

The 13.7 In. Flare Windshield will give your bike a style boost while the 11.3 In. Windscreen will give your Chieftain a more low-profile look. For riders looking for wind protection, a windshield that stops shortly

below eye level will prevent you from looking through bug splatter, while directing air over your head. For touring riders, we recommend the 21 In. Touring Windshield.

HARD LOWER FAIRINGS

2883984-XXX	\$929.99
-------------	----------

Includes Inner Lower Fairing. Visit the color-matched accessories section on page 140 for more details and color options. Requires Front Highway Bar (2884063-XXX), sold separately. Fits model year 2014-2022.



HARD LOWER FAIRINGS LOCK KIT

2881170	\$49.99
---------	---------

Fits model year 2015-2022.



MUSTACHE BAR SOFT CLOSEOUTS

2880941-01	Black	\$159.99
------------	-------	----------

Fits Mustache Highway Bar (standard on certain models). Made from vinyl for increased resistance to wear and tear from rocks, bugs and rain. Fits 2014-2022 Chieftain models.



TOP SELLER

FRONT HIGHWAY BAR SOFT CLOSEOUTS

2881125	Black	\$159.99
---------	-------	----------

Requires Front Highway Bars or Classic Front Highway Bars (standard on certain models). Made from vinyl for increased resistance to wear and tear from rocks, bugs and rain. Fits 2014-2022 Chieftain models.



WINDSHIELD BOLT KIT

2882230	\$29.99
---------	---------

For black styling. Fits model year 2014-2022.



FRONT HIGHWAY BAR

2884424-156	Chrome	\$409.99
2884424-266	Gloss Black	\$409.99

Fits model year 2014-2022. Standard on Chieftain models.



STEEL FRONT HIGHWAY BAR

2884063-156	Chrome	\$409.99
2884063-266	Gloss Black	\$409.99

Required to install Hard Lower Fairings (2883984-XXX), sold separately. Fits model year 2014-2022. Standard on 2019-2022 Roadmaster models.



MUSTACHE HIGHWAY BAR

2884425-156	Chrome	\$409.99
2884425-266	Gloss Black	\$409.99

Fits model year 2014-2022.



TOP SELLER

REAR HIGHWAY BARS

2879582-156	Chrome	\$309.99
2879582-266	Gloss Black	\$309.99

Fits model year 2014-2022. Chrome comes standard on Roadmaster.



FRONT FENDER BUMPER

2879551-156	Chrome	\$209.99
2880750-266	Gloss Black	\$204.99

Not compatible with Open Front Fender. Fits model year 2014-2022.



REAR FENDER BUMPER

2879550-156	Chrome	\$159.99
2880751-266	Gloss Black	\$154.99

Fits model year 2014-2020 with Classic Saddlebags.



PINNACLE SADDLEBAG PROTECTOR RAILS

2880917-156	Chrome	\$409.99
-------------	--------	----------

Fits 2014-2018 Chieftain models, 2019-2021 Chieftain Classic & 2015-2022 Roadmaster models.



2022

INTRO
2-11

FTR
12-27

SCOUT
28-51

INDIAN CHIEF
52-67

INDIAN SPRINGFIELD
68-91

CHIEFTAIN &
ROADMASTER
92-121

INDIAN CHALLENGER
122-135

POWERBAND AUDIO
136-139

COLOR-MATCHED
ACCESSORIES
140-143

GARAGE
144-151

eFTR
154-155

HANDLEBARS & CONTROLS



SELECT RIDER FLOORBOARDS



REDUCED REACH HANDLEBAR
 2882922-410 Chrome \$239.99
 Dealer installation recommended. Fits model year 2018-2022.



MID RISE HANDLEBAR
 2883450-266 Black* \$409.99
 2885138-410 Polished Stainless** \$349.99
 2885138-266 Black** \$349.99
 Dealer installation recommended. Fits model year 2018-2022.
 *Includes Extended Clutch Cable for 2014-2020 models.
 **No cable included.

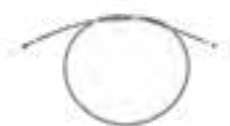

CLUTCH CABLE INSTALLATION KIT
 2885149 2021-2022 \$69.99
 2885148 2014-2020 \$69.99
 Fits model year 2014-2022.



TOP SELLER
HEATED HANDLEBAR GRIPS
 2883268 Black \$309.99
 Includes Wire Harness and Switch. Fits model year 2018-2022.
 Standard on Roadmaster.



TOP SELLER
SELECT HANDLEBAR GRIPS
 2882828-156 Chrome \$179.99
 2882828-468 Black \$179.99
 Fits model year 2018-2022.

SELECT RIDER FLOORBOARDS

2883021-156 Chrome \$519.99
 2883021-468 Black \$519.99
 Fits model year 2014-2022.



SELECT PASSENGER FLOORBOARDS

2882866-156 Chrome \$409.99
 2882866-468 Black \$409.99
 2880288 Mount \$109.99
 Requires Adjustable Passenger Floorboard Mounts (2880288), sold separately. Fits model year 2014-2022.
 Mount comes standard on Roadmaster.



TOP SELLER
SELECT TOE PEG

2880728-156 Chrome \$79.99
 2880728-468 Matte Black \$79.99
 Installs in place of the standard toe shifter peg and adds a great looking accessory to your Indian Motorcycle. Fits model year 2014-2022.



SELECT HEEL SHIFTER PEG

2880729-156 Chrome \$49.99
 2880729-468 Matte Black \$49.99
 Attaches to the Pinnacle Heel Shifter (2880103-156, -266, 2884772-156, -266), required, sold separately. Fits model year 2014-2022.



TOP SELLER
INFINITE HIGHWAY PEGS

2879572-156 Chrome \$309.99
 2879572-266 Gloss Black \$309.99
 Will work with Hard Lower Fairings. Fits model year 2014-2022.



TOP SELLER
PASSENGER PEGS

2880667-626 Matte Black \$209.99
 Fits model year 2014-2022. Standard on Chieftain Limited, Chieftain Classic & Roadmaster Dark Horse.



TOP SELLER
HEADRESS RIDER FLOORBOARD PADS

2879606-01 Polished Inlays \$209.99
 Use the Headdress Rider Floorboard Pads with your standard floorboards for an extra boost of style. Fits model year 2014-2022.



HEADRESS PASSENGER FLOORBOARD PADS

2884155 \$199.99
 Matches the Headdress Rider Floorboard Pads (2879606-01), sold separately. Add cushion to the floorboards and help isolate road vibration for a more comfortable ride. Installs easily over the Standard Passenger Floorboards, required, may be sold separately. Fits model year 2014-2022.



TOP SELLER
STANDARD PASSENGER FLOORBOARDS

2880293 Chrome \$199.99
 2880288 Mount \$109.99
 Fits model year 2014-2022. Standard on Roadmaster.



SELECT SCRIPT PEGS

2880106-266 Gloss Black \$159.99
 Can be installed on both the passenger pegs mount or highway bars peg mounts (see page 113 for highway bars. Highway bars and passenger pegs, 2879993-156 or 2880667-626, sold separately). Chieftain Dark Horse requires Pinnacle Passenger Peg Supports (2879993-156) or Passenger Pegs (2880667-626), each sold separately. Fits model year 2014-2022.



TOP SELLER
PINNACLE HEEL SHIFTER

2880103-156 Chrome* \$159.99
 2880103-463 Black* \$159.99
 2884772-156 Chrome** \$159.99
 2884772-266 Black** \$159.99
 This heel shifter gives you the convenience and comfort of heel up-shifts and toe down-shifts. *Fits model year 2014-2020.
 **Fits model year 2021-2022.



TOE RESTS

2881848-156 Chrome \$179.99
 Will work with Hard Lower Fairings. Requires a front highway bar, see page 113. Fits model year 2014-2022.



2022

INTRO 2-11
 FTR 12-27
 SCOUT 28-51
 INDIAN CHIEF 52-67
 INDIAN SPRINGFIELD 68-91

CHIEFTAIN & ROADMASTER 92-121

INDIAN CHALLENGER 122-135

POWERBAND AUDIO 136-139

COLOR-MATCHED ACCESSORIES 140-143

GARAGE 144-151

eFTR 154-155

LIGHTING & ELECTRICAL

PATHFINDER ADAPTIVE LED HEADLIGHT

MONITORS LEAN ANGLE REAL-TIME TO DELIVER OPTIMIZED ILLUMINATION

15 INDIVIDUAL BEAMS
ACTIVATE AS NEEDED

OPTIMIZED LIGHTING IN BOTH
LOW-BEAM & HIGH-BEAM

REDUCES GLARE FROM ROAD AND
DIRECTS LIGHT WHERE YOU NEED IT



PATHFINDER ADAPTIVE LED HEADLIGHT, PATHFINDER S LED DRIVING LIGHTS



PATHFINDER AUXILIARY LED SADDLEBAG LIGHTS

LOW BEAM



628
LUMENS



793
LUMENS



0°

BIKE LEAN ANGLE



32°

HIGH BEAM



1,213
LUMENS



1,316
LUMENS



0°

BIKE LEAN ANGLE



32°

PATHFINDER ADAPTIVE LED HEADLIGHT

2889459-156	Chrome	\$599.99
2889459-266	Black	\$599.99
2889636	Jumper*	\$29.99

Monitors bike's lean angle real-time to deliver optimized illumination. 15 individual beams activate as needed. Optimized lighting in both low-beam and high-beam. Reduces glare from road and directs light where you need it. Fits model year 2016-2022. *2016-2019 models require jumper (2889636), sold separately.



PATHFINDER S LED DRIVING LIGHTS

2884708-156	Chrome	\$199.99
2884708-266	Gloss Black	\$199.99

Fits 2019-2022 Chieftain, Chieftain Dark Horse, Chieftain Limited, Chieftain Elite, Roadmaster Dark Horse & Roadmaster Limited.



PATHFINDER S LED DRIVING LIGHTS MOUNT

2884711-156	Chrome	\$189.99
2884711-266	Gloss Black	\$189.99

Required to add Pathfinder S LED Driving Lights to 2019-2022 Chieftain, Chieftain Dark Horse, Chieftain Limited, Roadmaster Dark Horse & Roadmaster Limited. LED lights sold separately.



PATHFINDER LED DRIVING LIGHTS

2880621	\$309.99
---------	----------

Installs directly into standard light housings for powerful, brighter lighting. Fits 2014-2022 Chieftain & Chieftain Elite.



PATHFINDER LED HEADLIGHT

2884422	\$409.99
---------	----------

Enhanced visibility with powerful, clean LED light. Branded with the Indian Motorcycle script, "I". Dealer installation required. Fits model year 2020-2022.



RIDE COMMAND NAVIGATION & CELLULAR MODEM UPGRADE

2884468	\$519.99
---------	----------

This upgrade (for bikes with RIDE COMMAND without navigation) includes turn-by-turn navigation, advanced ride-planning tools, and live traffic and radar weather updates through cellular connectivity. Riders can connect their iPhone® and a supported Bluetooth® headset (not included) to utilize Apple CarPlay®. Subscription fees for some service may apply. Fits 2020-2022 Chieftain models. Standard on 2020-2022 Chieftain Limited, Chieftain Dark Horse, Chieftain Classic & Chieftain Elite.

TOP SELLER

GARAGE DOOR OPENER

2882132	\$169.99
---------	----------

Fits model year 2017-2022.



NEW

PATHFINDER AUXILIARY LED SADDLEBAG LIGHTS

2889224	\$179.99
---------	----------

Set of two. Add extra illumination and custom style. Lights install on rear face of each saddlebag. Plug-and-play connection. Not compatible with Classic Saddlebags. Fits 2019-2022 Chieftain, Chieftain Dark Horse, Chieftain Limited, Roadmaster Dark Horse & Roadmaster Limited.



RIDE COMMAND NAVIGATION

2883040	\$519.99
---------	----------

Adds navigation functionality to RIDE COMMAND for 2018 and 2019 Chieftain. Use RIDE COMMAND to view maps, plan routes, check location, get directions, and locate closest services. Fits 2018-2019 Chieftain. Standard on 2018-2019 Chieftain Dark Horse, Chieftain Limited & Chieftain Classic.

RAM® BALL MOUNT

2880920	\$109.99
---------	----------

Fits on clutch perch. For RAM® Ball accessories visit the RAM® website. Fits model year 2014-2022.



CHIEFTAIN MODELS & ROADMASTER MODELS

WHEELS & SUSPENSION

19 IN. 10-SPOKE FRONT WHEEL

2883235-440	Contrast Cut	\$569.99
-------------	--------------	----------

Recommended with Open Front Fender (2882761-XXX), Front Tire, 130/60B/19 (5415817), each sold separately. Fits model year 2018-2022. Standard on 2018-2019 Chieftain, Chieftain Limited, Chieftain Dark Horse & Chieftain Elite.



LOWERING REAR SHOCK KIT BY FOX®

2884423	2020-2022	\$469.99
---------	-----------	----------

Creates the stylish, low-slung look of a custom-built bike. Lowers bike 1 in. and maintains outstanding rear suspension performance. Lowers the seat for comfortable, confidence-inspiring riding position. Air-adjustable mono-tube shock and steel coil spring deliver reliable damping and rebound. Fits 2020-2022 Chieftain Classic & Roadmaster. Standard on 2020-2022 Chieftain, Chieftain Limited, Chieftain Dark Horse, Chieftain Elite & Roadmaster Dark Horse.



2022

INTRO
2-11

FTR
12-27

SCOUT
28-51

INDIAN CHIEF
52-67

INDIAN SPRINGFIELD
68-91

CHIEFTAIN &
ROADMASTER
92-121

INDIAN CHALLENGER
122-135

POWERBAND AUDIO
136-139

COLOR-MATCHED
ACCESSORIES
140-143

GARAGE
144-151

eFTR
154-155

CRAFTED STYLE PIECES

HEADRESS FENDER EMBLEM

2883668-156 Chrome \$109.99
2883668-266 Black \$109.99

Evokes classic Indian Motorcycle style and adds a custom look. Durable, die-cast emblem is engineered specifically for Open Front Fender. Proportions are perfect for this fender and emblem installs securely. Can also be installed on a tool box or in a rider cave. Fits model year 2014-2022.



INDIAN SCRIPT LICENSE PLATE FRAME

2882863-156 Chrome \$89.99

Check local laws as the frame may cover license plate information. Fits model year 2014-2022.



DISCONTINUED

PINNACLE FENDER TIP ACCENTS

2879646-156 Chrome \$149.99

Fits model year 2014-2022 with Valanced Front Fender. Standard on Roadmaster.
*Only available while supplies last.



SADDLEBAG TRIM

2881769 Black \$69.99

Fits model year 2014-2022 with a Valanced Front Fender.



TOP SELLER

PINNACLE MIRRORS

2880132-156 Chrome \$199.99

These mirrors feature a dynamic, laterally tapered design and have Indian Motorcycle script branding on the backsides. They are supported by forged arms for added strength and style. These mirrors directly replace the standard mirrors and provide outstanding visibility. Includes left and right-hand mirrors. Fits model year 2014-2022.



TOP SELLER

REDUCED REACH SIDE STAND

2881771-156 Chrome \$189.99
2881771-463 Black \$189.99

Allows shorter riders to reach the side stand while on the bike. Fits model year 2014-2022.



DISCONTINUED

CLUTCH LIFTER ARM

2879992-156 Chrome \$49.99

Replaces standard clutch lifter arm. No additional hardware required. Fits model year 2014-2022.
*Only available while supplies last.



HEADRESS LICENSE PLATE FRAME

2882864-156 Chrome \$89.99

Check local laws as the frame may cover license plate information. Fits model year 2014-2022.



DISCONTINUED

PINNACLE SOLO RIDER GRAB RAIL

2879604-156 Chrome \$259.99
2880752-266 Gloss Black \$259.99

Not compatible with Touring Seats or Rogue Seats. Fits model year 2014-2022.
*Only available while supplies last.



TOP SELLER

PINNACLE SEAT BOLT COVER

2880141-156 Chrome \$49.99

This chrome bracket covers the rear seat mounting bolt and has a chromed, knurled screw that prominently features Indian Motorcycle branding. Fits model year 2014-2022.



BLACK MIRRORS

2881013-463 Black \$129.99

These Black Mirrors greatly enhance the style of your motorcycle by helping to complete the blacked-out styling. These mirrors directly replace the standard mirrors and provide outstanding visibility. Fits model year 2014-2022.



BACKREST PLUGS

2881788 \$19.99

Fits into open tubes of Quick Release Passenger Sissy Bar required, sold separately for a clean, finished custom look. Fits 2014-2022 Chieftain models.



HEADLIGHT BEZEL BOLT KIT

2882229 Black \$19.99

Recommended with Bezel (2881770-XXX), sold separately. Fits model year 2014-2022.



CLASSIC HEADLIGHT BEZEL

2881770-XXX \$104.99 - \$154.99

Visit the color-matched accessories section on page 140 for more information. Fits 2014-2018 Chieftain, 2019-2020 Chieftain Classic & 2014-2022 Roadmaster.



BLACK DIAL FACE SPEEDOMETER & TACHOMETER

2883443 Black \$309.99

Dealer installation only. Fits model year 2017-2022. 2019-2022 models require updated software.



TOURING ENGINE COVER KIT

- A. 2883321-09 Steel Gray \$209.99
- B. 2883321-10 Ivory Cream \$209.99
- C. 2883321-11 Gloss Pearl White \$209.99
- D. 2883321-12 Star Silver \$209.99
- E. 2883321-13 Thunder Black Pearl \$209.99



Clock-wise beginning top-left, this kit includes an Air Box Cover, Console Insert, Primary Cover, Horn Cover and Cam Cover. These components install in place of the standard covers and give the bike colorful and coordinated custom style. Fits model year 2014-2022.

DISCONTINUED

PINNACLE PRIMARY COVER

2879563-156 Chrome \$49.99

Fits model year 2014-2022.
*Only available while supplies last.



DISCONTINUED

PINNACLE CAM COVER

2879564-156 Chrome \$49.99

Fits model year 2014-2022.
*Only available while supplies last.



HEADLIGHT BEZEL

2884000-156 Chrome \$99.99

Fits 2019-2022 Chieftain Limited, Chieftain Dark Horse & Roadmaster Dark Horse.



OPEN FRONT FENDER

2882761-XXX \$309.99 - \$799.99

Recommended with 19 In. 10-Spoke Front Wheel (2883235-266, -440) or Precision Machined Front Wheel (2884426-266W), each sold separately. Visit the color-matched accessories section on page 140 for more information. Fits model year 2014-2022.



NEW

LOCKING FUEL CAP

2884600-156 Chrome \$79.99
2884600-266 Black \$79.99

Includes one locking fuel cap, two keys and installation instructions. Fits model year 2015-2022.



2022

INTRO
2-11

FTR
12-27

SCOUT
28-51

INDIAN CHIEF
52-67

INDIAN SPRINGFIELD
68-91

CHIEFTAIN &
ROADMASTER
92-121

INDIAN CHALLENGER
122-135

POWERBAND AUDIO
136-139

COLOR-MATCHED
ACCESSORIES
140-143

GARAGE
144-151

eFTR
154-155

CRAFTED STYLE PIECES

GENUINE LEATHER FULL MUSTACHE HIGHWAY BAR WRAPS

2880942-01 Black \$209.99
 2880942-05 Desert Tan \$219.99

Requires Mustache Highway Bar (2884425-156, -266), sold separately. Fits model year 2014-2022.



GENUINE LEATHER PARTIAL MUSTACHE HIGHWAY BAR WRAPS

2880943-01 Black \$159.99
 2880943-05 Desert Tan \$164.99

Requires Mustache Highway Bar (2880287-266), sold separately. Fits model year 2014-2022.



DISCONTINUED

GENUINE LEATHER REAR MUD FLAP

2880009-05 Desert Tan (shown) \$89.99
 2879584-05 Desert Tan w/ Fringe \$89.99

Fits model year 2014-2022 with Classic Saddlebags. *Only available while supplies last.



GENUINE LEATHER GRIP WRAPS

2879999-01 Black (shown) \$59.99
 2879999-05 Desert Tan \$69.99

Fits model year 2014-2022.



GENUINE LEATHER FLOORBOARD TRIM

2880007-01 Black (shown) \$199.99
 2880007-05 Desert Tan \$209.99
 2880007-06 Desert Tan w/ Studs (shown) \$229.99

Fits model year 2014-2022.



2022

INTRO
2-11

FTR
12-27

SCOUT
28-51

INDIAN CHIEF
52-67

INDIAN SPRINGFIELD
68-91

CHIEFTAIN &
ROADMASTER
92-121

INDIAN CHALLENGER
122-135

POWERBAND AUDIO
136-139

COLOR-MATCHED
ACCESSORIES
140-143

GARAGE
144-151

eFTR
154-155

SISSY BAR LUGGAGE RACK, PASSENGER BACKREST PAD & QUICK RELEASE PASSENGER SISSY BAR

FULL ACCESSORY DETAILS AVAILABLE AT [INDIANMOTORCYCLE.COM/ACCESSORIES](https://www.IndianMotorcycle.com/Accessories)



ACCESSORIES FEATURED

1. Stage 1 Oval Slip-On Muffler Kit, Pg. 126
2. Slim Rogue Seat, Pg. 130
3. PowerBand Audio - Front Fairing, Pg. 136
4. Pathfinder Auxiliary LED Saddlebag Lights, Pg. 134
5. Powerplus Stage 1 Air Intake, Pg. 126



ACCESSORIES FEATURED

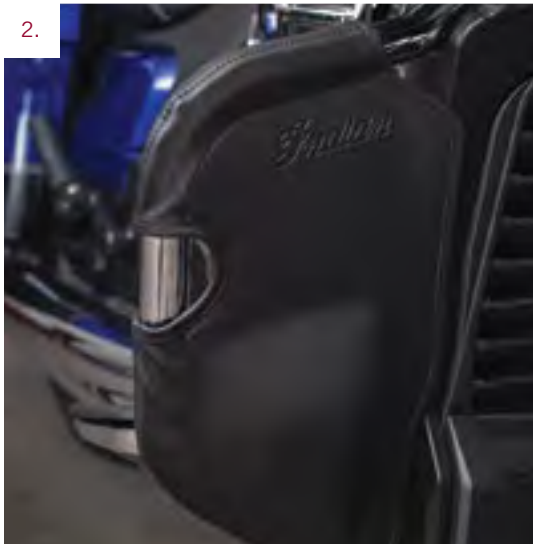

1. PowerBand Audio - Saddlebag Speakers, Pg. 136
2. Lower Closeouts, Pg. 131
3. 19 In. Windshield, Pg. 131
Low Rise Handlebar, Pg. 132
PowerBand Audio - Fairing Speakers, Pg. 136
4. Premium Rogue Heated Seat, Pg. 130
5. Powerplus Stage 2 Performance Cams, Pg. 126
6. Stage 1 Oval Slip-On Muffler Kit, Pg. 126



ENGINE PERFORMANCE

TOP SELLER

STAGE 1 OVAL SLIP-ON MUFFLER KIT



2884187-156  Chrome \$999.99
 2884187-266  Black \$999.99

 See legal disclaimer at bottom of right page. Fits model year 2020-2022.



TOP SELLER

THUNDERSTROKE STAGE 1 SLIP-ON EXHAUST KIT



2879769-156  Chrome \$699.99
 2879769-266  Matte Black \$699.99



 See legal disclaimer at bottom of right page. Requires exhaust tips, sold separately. Fits model year 2020-2022.



TOP SELLER

POWERPLUS STAGE 1 AIR INTAKE



2884461-266  Black (50 state) \$399.99
 2883737-266  Black (49 state) \$399.99

  See legal disclaimer at bottom of right page. Fits model year 2020-2022.



NEW

POWERPLUS STAGE 2 PERFORMANCE CAMS

2884573  2021-2022 (50 state) \$699.99
 2885178  2020-2022 \$699.99

Requires an Indian Motorcycle Stage 1 Muffler Kit or Exhaust Kit and a PowerPlus Stage 1 Air Intake, each sold separately. Increases horsepower by 10% over the standard engine configuration.  See legal at bottom of right page. Fits model year 2020-2022.



STRAIGHT EXHAUST TIPS

2880671-156 Chrome \$259.99
 2880671-266 Matte Black \$259.99

Machined billet aluminum with the largest inner-diameter giving these straight tips the deepest sound. Requires Stage 1 Exhaust (2879769-156, -266), sold separately. Fits model year 2020-2022.



TOP SELLER

SIX SHOOTER EXHAUST TIPS

2879530-156 Chrome \$309.99
 2879530-266 Matte Black \$309.99

Choose between 4 different mounting screw hole locations to position the exhaust tips to suit your style. Requires Stage 1 Exhaust (2879769-156, -266), sold separately. Fits model year 2020-2022.



GROOVED EXHAUST TIPS

2880799-156 Chrome \$309.99
 2880799-266 Matte Black \$309.99

Most visible from the road. Made of billet aluminum. Requires Stage 1 Exhaust (2879769-156, -266), sold separately. Fits model year 2020-2022.

 This kit meets EPA and CARB emission limits. Non-competition street use on motorcycles subject to USEPA noise limits & may violate federal noise limits. Please see inside back cover for further information.

 This kit meets EPA emission limits. Not legal for sale or use on non-competition pollution controlled vehicles in California. Tampering with emission-related parts can lead to substantial regulatory penalties. Non-competition street use may violate federal noise limits.

Performance parts are 50 state emissions compliant. Non-competition street use on motorcycles subject to USEPA noise limits & may violate federal noise limits. Indian Motorcycle recognizes the importance of environmental laws that regulate exhaust and noise emissions and is committed to developing performance parts that allow motorcycle enthusiasts to modify their vehicles in a safe and responsible manner. Emissions / Safety: Federal and many state laws prohibit the removal, modification, or rendering inoperative any part installed on motor vehicles by Indian Motorcycle affecting emissions or safety on motor vehicles manufactured for use on a public street or highway. Violation may result in fines. International markets, please consult your local laws for additional information. Noise: Certain Indian Motorcycle performance parts are subject to noise-related usage restrictions. The warning statement for these parts includes the statement, "On road use of this product may violate federal law." These products are designed for use on closed course motorcycles only and do not conform to U.S. EPA noise emission standards. Use on motorcycles subject to EPA noise regulations constitutes tampering and is a violation of Federal law unless it can be shown that such use does not cause the motorcycle to exceed applicable Federal Standards.

Compliant with SAE® J2825 standard. Does not void factory warranty. This complete kit conveniently includes the required Calibration Code that upgrades the Engine Control Module (ECM) software from standard to Stage 1, allowing this kit to be properly installed by your dealer. No additional software purchase necessary. Each kit is designated with a warning triangle to indicate the restrictions that may apply.



POWERPLUS STAGE 1 AIR INTAKE



2022

INTRO
2-11

FTR
12-27

SCOUT
28-51

INDIAN CHIEF
52-67

INDIAN SPRINGFIELD
68-91

CHIEFTAIN &
ROADMASTER
92-121

INDIAN CHALLENGER
122-135

POWERBAND AUDIO
136-139

COLOR-MATCHED
ACCESSORIES
140-143

GARAGE
144-151

eFTR
154-155

STORAGE & LUGGAGE

NEW

SPIRIT LAKE TOURING BAG

2889144-VBA Black \$369.99

Water-resistant vinyl bag with 6 storage pockets. Holds enough gear for one or two riders on a long-term trip. Includes branded rain cover. Recommended with Spirit Lake Rider Backrest Pad (2889299-VBA), sold separately. Fits model year 2021-2022.



NEW

SPIRIT LAKE DAY BAG

2889406-VBA Black \$199.99

Water-resistant vinyl bag with 6 storage pockets. Can be used on a bike or as a backpack or carry-on. Includes branded rain cover. Recommended with Spirit Lake Rider Backrest Pad (2889299-VBA), sold separately. Fits model year 2021-2022.



NEW

LOWER FAIRING STORAGE

2889337 Black \$199.99

Set of two. Storage for Hard Lower (2889475), required, sold separately. Fits model year 2021-2022.



TOP SELLER

DELUXE SADDLEBAG TRAVEL BAGS

2885131 Black \$154.99

Set of two. Fits model year 2020-2022.



NEW

SPIRIT LAKE RIDER BACKREST PAD

2889299-VBA Black Vinyl \$99.99

Weather-resistant vinyl. Attaches to the Spirit Lake Touring Bag (2889144-VBA) or Spirit Lake Day Bag (2889406-VBA), each sold separately, to create a comfortable rider backrest. Fits model year 2021-2022.



NEW

SPIRIT LAKE RACK BAG

2889145-VBA Black \$199.99

Water-resistant vinyl bag. Fits on Sissy Bar Luggage Rack (2880955-156, -266) or Trunk Rack (2884452-156, -266), each sold separately. Can also be mounted on passenger seat or on top of the Spirit Lake Touring Bag (2889144-VBA), sold separately. Includes branded rain cover. Fits model year 2021-2022.



DELUXE TRUNK TRAVEL BAG

2885132 Black \$144.99

Fits model year 2020-2022.



GENUINE LEATHER TOOL ROLL INSERT

2880944-01 Black \$59.99
2880944-05 Desert Tan \$69.99

Assemble your own assortment of tools to keep prepared, stow them away in the pockets — a perfect fit for convenient storage. Fits model year 2020-2022.



BUILD YOUR ACCESSORY TRUNK

STEP 1 - REQUIRED

QUICK RELEASE

QUICK RELEASE TRUNK BASE

2884048-156 Chrome \$519.99
2884048-266 Black \$519.99

Features Quick Release technology so riders can quickly remove their trunk without tools. Required for Quick Release Trunk (2884046-XXX). Mounts directly onto trunk to allow for trunk installation on bike. Made from steel with a chrome or black finish. Fits model year 2020-2022.



STEP 2 - REQUIRED

TRUNK INSTALLATION KIT

2889065 2020-2022 \$159.99

Required for proper installation of an accessory Quick Release Trunk. Contains set of mounting spools and harnesses. Supplies electrical power to Quick Release Trunk. Fits model year 2020-2022. Dealer installation recommended.



STEP 2 - OPTIONAL

ADD POWERBAND AUDIO

See page 136 for details.

STEP 3 - REQUIRED

QUICK RELEASE

QUICK RELEASE TRUNK

2884046-XXX \$929.99 - \$3,599.99

Visit the color-matched accessories section on page 140 for more information. Fits model year 2020-2022.



STEP 4 - REQUIRED

A. GENUINE LEATHER TRUNK BACKREST PAD

2889056-VBA Slim Black Vinyl \$359.99

These backrests are recommended with coordinating accessory seats on page 130. Fits model year 2020-2022.

NEW

B. ULTRA-PREMIUM TRUNK PASSENGER PAD

2889056-VBB Black Vinyl \$359.99

Compatible with (2889356-VBA & 2889150-VBA) touring seats. Fits model year 2020-2022.



STEP 5 - OPTIONAL

NEW

PREMIUM TRUNK LINER

2889606 \$119.99

Required to install Trunk Mounted Antenna (2889596), sold separately. Fits model year 2020-2022.



NEW

TRUNK MOUNTED ANTENNA

2889596 Black \$249.99

22 In. tall antenna mounts on right corner of trunk for enhanced radio reception. Requires Premium Trunk Liner (2889606), sold separately. Fits model year 2020-2022.



TRUNK RACK

2884452-156 Chrome \$309.99
2884452-266 Gloss Black \$309.99

Fits model year 2020-2022.



TRUNK ORGANIZER

2880298 Black \$49.99

Requires Quick Release Trunk (2884046-XXX), sold separately. Fits model year 2020-2022.



SPIRIT LAKE TOURING BAG



2022

INTRO
2-11

FTR
12-27

SCOUT
28-51

INDIAN CHIEF
52-67

INDIAN SPRINGFIELD
68-91

CHIEFTAIN &
ROADMASTER
92-121

INDIAN CHALLENGER
122-135

POWERBAND AUDIO
136-139

COLOR-MATCHED
ACCESSORIES
140-143

GARAGE
144-151

eFTR
154-155

SEATS & BACKRESTS



SLIM ROGUE SEAT

NEW

PREMIUM ROGUE HEATED SEAT

2889356-VBA Black Vinyl \$899.99
Fits model year 2020-2022.



SLIM ROGUE SEAT

2884905-VBA Black Vinyl \$449.99
Fits model year 2020-2022.



TOP SELLER

PASSENGER BACKREST PAD

2883728-VBA Black Vinyl \$259.99
Leather look all weather black vinyl. Requires Quick Release Passenger Sissy Bar, sold separately. Fits model year 2020-2022.



TOP SELLER

GENUINE LEATHER RIDER BACKREST PAD

2879542-VBA Rogue Black Vinyl \$389.99
2879543 Backrest Mount (not shown) \$159.99
Fits model year 2020-2022.



TOP SELLER

QUICK RELEASE

QUICK RELEASE UNIVERSAL PASSENGER SISSY BAR

2884186-156 12 In. Chrome \$469.99
2884186-266 12 In. Gloss Black \$449.99

Requires Passenger Backrest Pad (2883728-VBA), sold separately. Backrest Plugs (2881788), sold separately fit into the open tubes of the Quick Release Universal Passenger Sissy Bar, for a clean finished custom look. Fits model year 2020-2022.



CLIMACOMMAND COMFORT SEAT

2884903-VBA Black Vinyl \$1,199.99
Fits model year 2020-2022.



NEW

PREMIUM TOURING SEAT

2889150-VBA Black Vinyl \$429.99
Fits model year 2020-2022.



EXTENDED REACH ROGUE SEAT

2883869-VBA Black Vinyl \$449.99
Repositions the rider 2 in. farther back and about 1 in. higher, which provides the fullest possible leg extension for long-riding comfort. Fits model year 2020-2022.



LOW PROFILE PASSENGER PAD

2884727-VBA Black Vinyl \$149.99
Only compatible with Low Profile Quick Release Passenger Sissy Bar (2884619-156, -266), sold separately. Compatible with the following Rogue Seats: 2884905-VBA, 2883869-VBA & 2020-2022 Indian Challenger standard seat. Fits model year 2020-2022.



QUICK RELEASE

LOW PROFILE QUICK RELEASE PASSENGER SISSY BAR

2884619-156 Chrome \$299.99
2884619-266 Gloss Black \$299.99

Only compatible with Low Profile Passenger Pad (2884620-VBA, 2884727-VBA), sold separately. Fits model year 2020-2022.



TOP SELLER

SISSY BAR LUGGAGE RACK

2880955-156 Chrome \$259.99
2880955-266 Gloss Black \$259.99

Requires Quick Release Passenger Sissy Bar, sold separately. Fits model year 2020-2022.



PROTECTION



11 IN. CURVED WINDSHIELD

PICKING THE RIGHT WINDSHIELD

The 11 In. Curved Windshield will give your bike a style boost while the 11 In. Low Windscreen will give your bike a more low-profile look. For riders looking for wind protection, a windshield that stops shortly below eye level will prevent

you from looking through bug splatter, while directing air over your head. For touring riders, we recommend the 19 In. Tall Windshield.



TOP SELLER

11 IN. CURVED WINDSHIELD

2883706-02 Tinted \$229.99
11 In. tall. Fits model year 2020-2022.

TOP SELLER

11 IN. LOW WINDSHIELD

2883707-02 Tinted \$179.99
11 In. tall. Fits model year 2020-2022.

TOP SELLER

16 IN. MID WINDSHIELD

2883708-02 Tinted \$229.99
16 In. tall. Fits model year 2020-2022.

TOP SELLER

19 IN. TALL WINDSHIELD

2883709-01 Clear \$229.99
19 In. tall. Fits model year 2020-2022.

TOP SELLER

FRONT HIGHWAY BARS

2884177-156 Chrome \$409.99
2884177-266 Gloss Black \$409.99

Fits model year 2020-2022. Chrome comes standard on Indian Challenger Limited.



LOWER CLOSEOUTS

2884906 Black \$199.99
Fits model year 2020-2022.

TOP SELLER

REAR HIGHWAY BARS

2879582-156 Chrome \$309.99
2879582-266 Gloss Black \$309.99

Fits model year 2020-2022.



NEW

HARD LOWER FAIRINGS

2889475-XXX \$929.99

Visit the color-matched accessories section on page 140 for more information. Fits model year 2020-2022.



2022

INTRO
2-11

FTR
12-27

SCOUT
28-51

INDIAN CHIEF
52-67

INDIAN SPRINGFIELD
68-91

CHIEFTAIN &
ROADMASTER
92-121

INDIAN CHALLENGER
122-135

POWERBAND AUDIO
136-139

COLOR-MATCHED
ACCESSORIES
140-143

GARAGE
144-151

eFTR
154-155



SELECT RIDER FLOORBOARDS



REDUCED REACH HANDLEBAR*

2884390-410 Polished Stainless \$209.99

Dealer installation recommended.
Fits model year 2020-2022.



TOP SELLER

MID RISE HANDLEBAR*

2884389-410 Polished Stainless \$409.99
2884575-266 Gloss Black \$409.99

Dealer installation recommended.
Fits model year 2020-2022.



LOW RISE HANDLEBAR*

2885177-410 Polished Stainless \$249.99
2885176-266 Gloss Black \$249.99

Dealer installation recommended.
Fits model year 2020-2022.



TOP SELLER

HEATED HANDLEBAR GRIPS

2883268 Black \$309.99

Includes Wire Harness and Switch.
Fits model year 2020-2022.



TOP SELLER

SELECT HANDLEBAR GRIPS

2882828-156 Chrome \$179.99
2882828-468 Black \$179.99

Fits model year 2020-2022.

SELECT RIDER FLOORBOARDS

2883021-156 Chrome \$519.99
2883021-468 Black \$519.99

Fits model year 2020-2022.



TOP SELLER

HEADRESS RIDER FLOORBOARD PADS

2879606-01 Polished Inlays \$209.99

Use the Headdress Rider Floorboard Pads with your standard floorboards for an extra boost of style.
Fits model year 2020-2022.



SELECT PASSENGER FLOORBOARDS

2882866-156 Chrome \$409.99
2882866-468 Black \$409.99
2880288 Mount \$109.99

Requires Adjustable Passenger Floorboard Mounts (2880288), sold separately. Fits model year 2020-2022.



HEADRESS PASSENGER FLOORBOARD PADS

2884155 \$199.99

Matches the Headdress Rider Floorboard Pads (2879606-01), sold separately. Add cushion to the floorboards and help isolate road vibration for a more comfortable ride. Installs easily over the Standard Passenger Floorboards, required, may be sold separately. Fits model year 2020-2022.



TOP SELLER

SELECT TOE PEG

2880728-156 Chrome \$79.99
2880728-468 Matte Black \$79.99

Installs in place of the standard toe shifter peg and adds a great looking accessory to your Indian Motorcycle. Fits model year 2020-2022.



TOP SELLER

STANDARD PASSENGER FLOORBOARDS

2880293 Chrome \$199.99
2880288 Mount \$109.99

Fits model year 2020-2022.



SELECT HEEL SHIFTER PEG

2880729-156 Chrome \$49.99
2880729-468 Matte Black \$49.99

Attaches to the Pinnacle Heel Shifter (2880103-156,-266, 2884772-156,-266), required, sold separately. Fits model year 2020-2022.



TOE RESTS

2881848-156 Chrome \$179.99

Will work with Hard Lower Fairings. Requires front highway bars, see page 131. Fits model year 2020-2022.



TOP SELLER

INFINITE HIGHWAY PEGS

2879572-156 Chrome \$309.99
2879572-266 Gloss Black \$309.99

Will work with Hard Lower Fairings.
Fits model year 2020-2022.



TOP SELLER

PINNACLE HEEL SHIFTER

2880103-156 Chrome \$159.99
2880103-463 Black \$159.99

This heel shifter gives you the convenience and comfort of heel up-shifts and toe down-shifts. Fits model year 2020-2022.



2022

INTRO
2-11

FTR
12-27

SCOUT
28-51

INDIAN CHIEF
52-67

INDIAN SPRINGFIELD
68-91

CHIEFTAIN &
ROADMASTER
92-121

INDIAN CHALLENGER
122-135

POWERBAND AUDIO
136-139

COLOR-MATCHED
ACCESSORIES
140-143

GARAGE
144-151

eFTR
154-155

LIGHTING & ELECTRICAL

PATHFINDER ADAPTIVE LED HEADLIGHT

2889459-156 Chrome \$599.99
2889459-266 Black \$599.99

Monitors bike's lean angle real-time to deliver optimized illumination. 15 individual beams activate as needed. Optimized lighting in both low-beam and high-beam. Reduces glare from road and directs light where you need it. Fits model year 2020-2022.



PATHFINDER S LED DRIVING LIGHTS MOUNT

2884899-156 Chrome \$189.99
2884899-266 Matte Black \$189.99

Required to add Pathfinder S LED Driving Lights to 2020-2022 Indian Challenger models. LED lights sold separately.



PATHFINDER AUXILIARY LED SADDLEBAG LIGHTS

2889224 \$179.99

Set of two. Add extra illumination and custom style. Lights install on rear face of each saddlebag. Plug-and-play connection. Not compatible with Classic Saddlebags. Fits model year 2020-2022.



GARAGE DOOR OPENER

2882132 \$169.99

Fits model year 2020-2022.



PATHFINDER S LED DRIVING LIGHTS

2884708-156 Chrome \$199.99
2884708-266 Gloss Black \$199.99

Fits model year 2020-2022.



PATHFINDER S LOWER FAIRING INSTALLATION KIT

2889476-266 Black \$129.99

Plug and play harness required to add Pathfinder S LED Driving Lights (2884708-156, -266) to the Hard Lower Fairings (2889475-XXX), both required, sold separately. Fits model year 2020-2022.



PUDDLE LIGHT

2884308 \$99.99

Fits model year 2020-2022. Standard on 2020-2022 Indian Challenger Dark Horse & Indian Challenger Limited.



RIDE COMMAND NAVIGATION & CELLULAR MODEM UPGRADE

2884468 \$519.99

This upgrade (for bikes with RIDE COMMAND without navigation) includes turn-by-turn navigation, advanced ride-planning tools, and live traffic and radar weather updates through cellular connectivity. Riders can connect their iPhone® and a supported Bluetooth® headset (not included) to utilize Apple CarPlay®. Subscription fees for some service may apply. Fits model year 2020-2022.

CRAFTED STYLE PIECES

INDIAN SCRIPT LICENSE PLATE FRAME

2882863-156 Chrome \$89.99

Check local laws as the frame may cover license plate information. Fits model year 2020-2022.



HEADDRESS LICENSE PLATE FRAME

2882864-156 Chrome \$89.99

Check local laws as the frame may cover license plate information. Fits model year 2020-2022.



TOP SELLER

PINNACLE MIRRORS

2880132-156 Chrome \$199.99

These mirrors feature a dynamic, laterally tapered design and have Indian Motorcycle script branding on the backsides. They are supported by forged arms for added strength and style. These mirrors directly replace the standard mirrors and provide outstanding visibility. Includes left and right-hand mirrors. Fits model year 2020-2022.



PATHFINDER AUXILIARY LED SADDLEBAG LIGHTS

PATHFINDER ADAPTIVE LED HEADLIGHT

MONITORS LEAN ANGLE REAL-TIME TO DELIVER OPTIMIZED ILLUMINATION

15 INDIVIDUAL BEAMS ACTIVATE AS NEEDED

OPTIMIZED LIGHTING IN BOTH LOW-BEAM & HIGH-BEAM

REDUCES GLARE FROM ROAD AND DIRECTS LIGHT WHERE YOU NEED IT

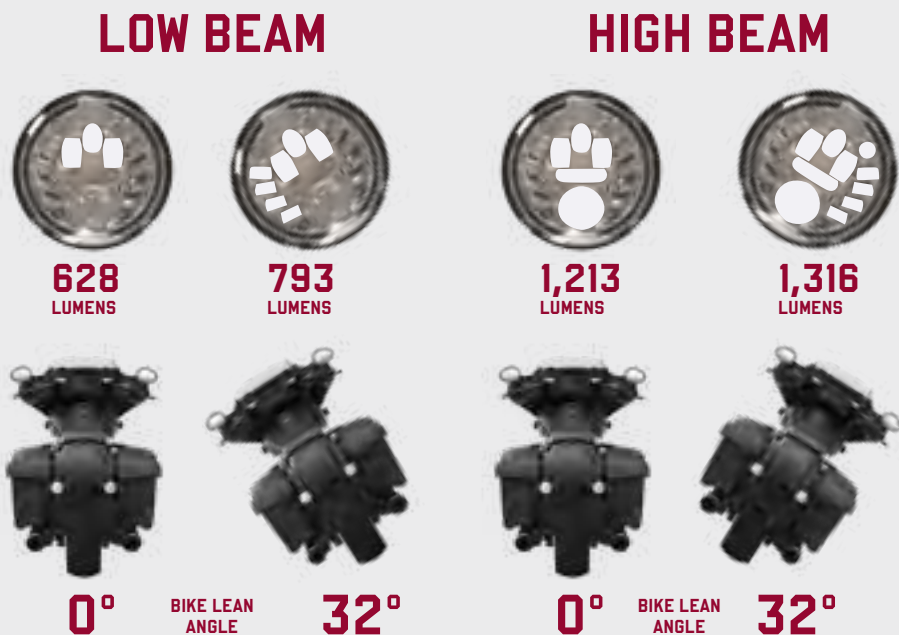

2022

INTRO
2-11

FTR
12-27

SCOUT
28-51

INDIAN CHIEF
52-67

INDIAN SPRINGFIELD
68-91

CHIEFTAIN & ROADMASTER
92-121

INDIAN CHALLENGER
122-135

POWERBAND AUDIO
136-139

COLOR-MATCHED ACCESSORIES
140-143

GARAGE
144-151

eFTR
154-155

POWERBAND AUDIO UPGRADES

THE LOUDEST AUDIO IN INDIAN MOTORCYCLE HISTORY



2022

INTRO
2-11

FTR
12-27

SCOUT
28-51

INDIAN CHIEF
52-67

INDIAN SPRINGFIELD
68-91

CHIEFTAIN & ROADMASTER
92-121

INDIAN CHALLENGER
122-135

POWERBAND AUDIO
136-139

COLOR-MATCHED ACCESSORIES
140-143

GARAGE
144-151

eFTR
154-155



FRONT FAIRING AUDIO UPGRADE



SADDLEBAG AUDIO UPGRADE



CLASSIC SADDLEBAG AUDIO



TRUNK AUDIO UPGRADE

SPEAKERS



TOP SELLER

POWERBAND AUDIO 5 1/4 IN. AMPLIFIED SPEAKERS

2883926 \$499.99

Upgrades Front Fairing Audio on 2019-2022 Chieftain & Roadmaster. 30% louder than standard with 9 band equalizer, pre-tuned settings and integration with RIDE COMMAND.

Also upgrades Hard Lower Fairing Audio on 2020-2022 Indian Challenger models with stock audio. If Trunk and/or Saddlebag Audio is installed, 2889057 is required instead.



POWERBAND AUDIO 6 1/2 IN. AMPLIFIED SPEAKERS

2884309 \$599.99

Upgrades Front Fairing Audio on 2020-2022 Indian Challenger models. 30% louder than standard with 9 band equalizer, pre-tuned settings and integration with RIDE COMMAND.



POWERBAND AUDIO 6 1/2 IN. AMPLIFIED SADDLEBAG SPEAKERS

2884342 \$649.99

After upgrading Front Fairing Audio, upgrades Saddlebag Audio on 2019-2022 Chieftain & Roadmaster models and 2020-2022 Indian Challenger models. 50% louder than standard with 9 band equalizer, pre-tuned settings and integration with RIDE COMMAND.

Also fits 2019-2022 Indian Springfield.



POWERBAND AUDIO AMPLIFIED TRUNK SPEAKERS

2889057 \$599.99

After Front Fairing Audio is upgrade, add to upgrade Trunk Audio on 2019-2022 Indian Springfield, Chieftain, Roadmaster, Indian Challenger models.

Also upgrades Hard Lower Fairing Audio on 2020-2022 Indian Challenger models if Trunk and/or Saddlebag audio are installed.

SPEAKER BEZELS & LIDS



POWERBAND AUDIO SADDLEBAG SPEAKER BEZELS

A. Saddlebag Speaker Bezels*
2883665-156 Chrome \$199.99
2883665-266 Black \$199.99

B. Classic Saddlebag Speaker Bezels**
2883669-156 Chrome \$409.99
2883669-266 Black \$199.99

C. Lower Fairing Speaker Bezels***
2889595-156 Chrome \$199.99
2889595-266 Black \$199.99

*Fits 2019-2022 Indian Springfield Dark Horse, Chieftain, Chieftain Limited, Chieftain Dark Horse, Roadmaster Dark Horse & Indian Challenger.
**Fits 2019-2022 Indian Springfield, Chieftain Classic & Roadmaster.
***Fits 2020-2022 Indian Challenger.



SADDLEBAG LID

CLASSIC SADDLEBAG LID

POWERBAND AUDIO SADDLEBAG SPEAKER LIDS

2883666-XXX Saddlebag Lid* \$519.99 - \$529.99
2883670-XXX Classic Saddlebag Lid** \$519.99 - \$669.99

Injection-molded lids are precision-engineered and manufactured like standard lids. They host PowerBand Audio 6 1/2 In. Amplified Saddlebag Speakers and Speaker Bezels, each sold separately. These lids replace standard lids, and are color-matched with the same premium finishes as standard lids. Install easily and fit perfectly. See page 140 for color options.
*Fits 2019-2022 Indian Springfield Dark Horse, Chieftain, Chieftain Limited, Chieftain Dark Horse, Roadmaster Dark Horse & Roadmaster Limited.
** Fits 2019-2022 Indian Springfield, Chieftain Classic & Roadmaster.

INSTALLATION KITS

NEW LOWER FAIRING INSTALLATION KIT

2889294 \$129.99

Required to install PowerBand Audio 5 1/4 In. Amplified Speakers (2883926 or 2889057) in Hard Lower Fairings (2889475), each sold separately. Fits 2020-2022 Indian Challenger.

SADDLEBAG INSTALLATION KIT

2883924* \$99.99
2883923** \$99.99
2884469*** \$199.99

Required to install PowerBand Audio 6 1/2 In. Amplified Saddlebag Speakers in Saddlebag Lids. Includes all necessary harnesses.
*Fits 2019-2022 Chieftain, Chieftain Limited, Chieftain Dark Horse, Roadmaster Dark Horse & Indian Challenger models.
**Classic Saddlebag Lids. Fits 2019-2022 Chieftain Classic & Roadmaster.
***Fits 2020-2022 Indian Springfield Dark Horse.

SADDLEBAG AUDIO RETRO KIT

2884608 \$349.99

Includes speakers, harnesses and installation hardware. Requires Classic Saddlebag Lids (2883670-XXX) and Classic Saddlebag Speaker Bezels (2883669-XXX), each sold separately. Fits 2014-2018 Thunderstroke models with hard saddlebags.

Visit our website to shop audio for model years 2018 and older.

FULL ACCESSORY DETAILS AVAILABLE AT INDIANMOTORCYCLE.COM/ACCESSORIES

WHAT YOU NEED TO ADD POWERBAND AUDIO

2019-2022 INDIAN SPRINGFIELD		2019-2022 CHIEFTAIN		
POWERBAND AUDIO 2019-2022 INDIAN SPRINGFIELD & 2019 INDIAN SPRINGFIELD DARK HORSE UPGRADED SADDLEBAG AUDIO	POWERBAND AUDIO 2020-2022 INDIAN SPRINGFIELD DARK HORSE UPGRADED SADDLEBAG AUDIO	POWERBAND AUDIO UPGRADED FRONT FAIRING AUDIO	POWERBAND AUDIO PLUS UPGRADED FAIRING & SADDLEBAG AUDIO	POWERBAND AUDIO PLUS UPGRADED FAIRING, SADDLEBAG & TRUNK AUDIO WITH ACCESSORY TRUNK
COMPONENTS 6 ½ In. Amplified Saddlebag Speakers 2884342 Classic Saddlebag Installation Kit 2883925 Classic Saddlebag Speaker Lids 2883670-XXX* Classic Saddlebag Speaker Bezels 2883669-XXX**	COMPONENTS 6 ½ In. Amplified Saddlebag Speakers 2884342 Saddlebag Installation Kit 2884469 Saddlebag Speaker Lids 2883666-XXX* Saddlebag Speaker Bezels 2883665-XXX**	COMPONENTS 5 ¼ In. Amplified Speakers 2883926	COMPONENTS 5 ¼ In. Amplified Speakers 2883926 6 ½ In. Amplified Saddlebag Speakers 2884342 CHIEFTAIN MODELS (EXCEPT CHIEFTAIN CLASSIC): Saddlebag Installation Kit 2883924 Saddlebag Speaker Lids 2883666-XXX* Saddlebag Speaker Bezels 2883665-XXX** CHIEFTAIN CLASSIC: Classic Saddlebag Installation Kit 2883923 Classic Saddlebag Speaker Lids 2883670-XXX* Classic Saddlebag Speaker Bezels 2883669-XXX**	COMPONENTS 5 ¼ In. Amplified Speakers 2883926 6 ½ In. Amplified Saddlebag Speakers 2884342 Amplified Trunk Speakers 2889057 Quick Release Trunk 2884046-XXX* Trunk Installation Kit 2884007*** CHIEFTAIN MODELS (EXCEPT CHIEFTAIN CLASSIC): Saddlebag Installation Kit 2883924 Saddlebag Speaker Lids 2883666-XXX* Saddlebag Speaker Bezels 2883665-XXX** CHIEFTAIN CLASSIC: Classic Saddlebag Installation Kit 2883923 Classic Saddlebag Speaker Lids 2883670-XXX* Classic Saddlebag Speaker Bezels 2883669-XXX**

2019-2022 ROADMASTER		2020-2022 INDIAN CHALLENGER		
POWERBAND AUDIO UPGRADED FAIRING & TRUNK AUDIO	POWERBAND AUDIO PLUS UPGRADED FAIRING, SADDLEBAG & TRUNK AUDIO	POWERBAND AUDIO UPGRADED FRONT FAIRING AUDIO	POWERBAND AUDIO PLUS UPGRADED FAIRING, SADDLEBAG & LOWER FAIRING AUDIO	POWERBAND AUDIO PLUS UPGRADED FAIRING, SADDLEBAG, LOWER FAIRING & TRUNK AUDIO
COMPONENTS 5 ¼ In. Amplified Speakers 2883926 TRUNK UPGRADE 5 ¼ In. Amplified Speakers 2883926 <small>(In order to upgrade Trunk Audio, Fairing Audio must be upgraded first)</small>	COMPONENTS 5 ¼ In. Amplified Speakers 2883926 (Buy 2) <small>Two speaker kits required</small> 6 ½ In. Amplified Saddlebag Speakers 2884342 ROADMASTER: Classic Saddlebag Installation Kit 2883923 Classic Saddlebag Speaker Lids 2883670-XXX* Classic Saddlebag Speaker Bezels 2883669-XXX** ROADMASTER DARK HORSE & ROADMASTER LIMITED: Saddlebag Installation Kit 2883924 Saddlebag Speaker Lids 2883666-XXX* Saddlebag Speaker Bezels 2883665-XXX**	COMPONENTS 6 ½ In. Amplified Speakers 2884309	COMPONENTS 6 ½ In. Amplified Speakers 2884309 6 ½ In. Amplified Saddlebag Speakers 2884342 Saddlebag Installation Kit 2883924 Saddlebag Speaker Lids 2883666-XXX* Saddlebag Speaker Bezels 2883665-XXX** LOWER FAIRING: 5 ¼ In. Amplified Trunk Speakers 2889057 <small>(Use 2883926 instead of 2889057 to add Lower Fairing to stock audio. 2889057 is required with Saddlebag or Trunk audio.)</small> Lower Fairing Speaker Bezels 2889595-XXX** Lower Fairing Installation Kit 2889294	COMPONENTS 6 ½ In. Amplified Speakers 2884309 6 ½ In. Amplified Saddlebag Speakers 2884342 Saddlebag Installation Kit 2883924 Saddlebag Speaker Lids 2883666-XXX* Saddlebag Speaker Bezels 2883665-XXX** Amplified Trunk Speakers 2889057 LOWER FAIRING: 5 ¼ In. Amplified Trunk Speakers 2889057 <small>(Use 2883926 instead of 2889057 to add Lower Fairing to stock audio. 2889057 is required with Saddlebag or Trunk audio.)</small> Lower Fairing Speaker Bezels 2889595-XXX** Lower Fairing Installation Kit 2889294



CLIMACOMMAND SEAT HARNESS FITMENT					
CLIMACOMMAND ROGUE (2884558) & CLIMACOMMAND CLASSIC (2884559) SEATS					
YEAR	MODEL	QUICK RELEASE TRUNK?	RIDE COMMAND CAPABLE?	ADDITIONAL HARNESS NEEDED	HARNESS APPLICATION NOTES (2415866 INCLUDED)
2014-2018	ALL MODELS	Y OR N	N	NONE	STOCK CHASSIS HARNESS HAS A 2 PIN HEATED SEAT CONNECTOR TO MATE WITH 2415866
2019	CHIEFTAIN MODELS	Y	N	NONE	2414436 COMES WITH TRUNK INSTALLATION KIT AND HAS 2 PIN HEATED SEAT CONNECTOR TO MATE WITH 2415866
		N	N	2415036	2415036 CONNECTS TO TRUNK CONNECTOR AND HAS 2 PIN HEATED SEAT CONNECTOR TO MATE WITH 2415866
2020-2022	CHIEFTAIN MODELS	N	Y	2415746	2415746 CONNECTS TO CHASSIS HARNESS TRUNK CONNECTOR AND HAS 4 PIN HEATED SEAT CONNECTOR, 2415866 CAN BE DISCARDED
		Y	Y	2415332	2415332 CONNECTS TO CHASSIS HARNESS TRUNK CONNECTOR, HAS 4 PIN HEATED SEAT CONNECTOR AND BREAKOUT FOR TRUNK, 2415866 CAN BE DISCARDED
2019	ROADMASTER MODELS	STOCK	N	NONE	STOCK TRUNK HARNESS 2414436 HAS 2 PIN HEATED SEAT CONNECTOR TO MATE WITH 2415866
2020-2022			Y		BIKE IS EQUIPPED WITH 2415332 FROM FACTORY AND HAS 4 PIN HEATED SEAT CONNECTOR, 2415866 CAN BE DISCARDED
2019-2022	ALL OTHER THUNDERSTROKE MODELS	Y OR N	N	NONE	NON FAIRING BIKES: CHASSIS HARNESS COMES WITH 2 PIN HEATED SEAT CONNECTOR TO MATE WITH 2415866, NO RIDE COMMAND ON THESE BIKES

CLIMACOMMAND CLASSIC SEAT (2884419)				
YEAR	MODEL	QUICK RELEASE TRUNK?	RIDE COMMAND CAPABLE?	ADDITIONAL HARNESS NEEDED
2014-2018	CHIEFTAIN & ROADMASTER MODELS	Y OR N	N	NONE
2019		Y		NONE
		N		2415036
2020-2022	USE 2884558 OR 2884559 FOR RIDE COMMAND CONTROL			
2014-2022	ALL OTHER THUNDERSTROKE MODELS	Y OR N	N	NONE

HARNESS GUIDE	
PART #	NAME
2414641	QUICK RELEASE TRUNK HARNESS WITH 2 PIN SEAT PLUG
2415332	QUICK RELEASE TRUNK HARNESS WITH 4 PIN SEAT PLUG
2415036	16 TO 2 PIN SEAT ADAPTER HARNESS
2415746	16 TO 4 PIN SEAT ADAPTER HARNESS
2415866	2 TO 4 PIN SEAT ADAPTER HARNESS (INCLUDED WITH SEATS 2884558 & 2884559)



2022

INTRO
2-11

FTR
12-27

SCOUT
28-51

INDIAN CHIEF
52-67

INDIAN SPRINGFIELD
68-91

CHIEFTAIN & ROADMASTER
92-121

INDIAN CHALLENGER
122-135

POWERBAND AUDIO
136-139

COLOR-MATCHED ACCESSORIES
140-143

GARAGE
144-151

eFTR
154-155

COLOR-MATCHED ACCESSORIES

Choosing to install Indian Motorcycle color-matched painted accessories means you get the best custom look for your bike direct from the factory. If you have the bike, we have the color to match it.

Painted parts may require a 30-day lead time.



Indy Red -293	Star Silver -354	Blue Diamond -447	Thunder Black Smoke -463	Sunblaze Orange -493	Solar Flare Yellow -517	Pearl White -566	Silver Smoke -581	Thunder Black -266	
Star Silver Smoke -601	Brilliant Blue -620	Burgundy Metallic -629	Titanium Smoke -632	Indian Motorcycle Red -639	Springfield Blue -640	Ivory Cream -646	Titanium Metallic -653	Patriot Red Pearl -665	
Thunder Black Pearl -666	Willow Green -670	White Smoke -675	Wildfire Red -676	Sagebrush Smoke -685	Steel Gray -692	Spirit Blue Metallic -694	Steel Gray Smoke -706	Maroon Metallic -711	
Polished Bronze -714	Radar Blue -724	Brilliant Blue Smoke -725	Deepwater Metallic -727	Ghost Gray -728	Dirt Track Smoke -729	Bronze Smoke -731	Fireglow Red Candy -733	Sky Blue -737	
Dragon Green -740	Metallic Jade -745	Burnt Orange Metallic -750	Coastal Green -753	Burnished Metallic -754	Dark Walnut -756	Ruby Metallic -759	Ruby Smoke -760	Deep Brass Smoke -768	
Sandstone Smoke -773	Thunder Black Vivid Crystal -794	Black Metallic -800	Stealth Gray -804	Azure Crystal -809	Crimson Metallic -819	Alumina Jade -822	Burnt Orange Metallic Smoke -823	Blue Slate Smoke -826	
Alumina Jade Smoke -827	Maroon Metallic Smoke -833	Stealth Gray Azure Crystal -834	Storm Blue -849	Riot Orange Metallic -853	Black Smoke -866	Silver Quartz Metallic -869	Silver Quartz Smoke -870	Riot Orange Smoke -871	
Dark Lime Metallic -873	Quartz Gray -875	Black Azure Crystal -878	Springfield Blue over Ivory Cream with Gold Pinstripe -1407	Indian Motorcycle Red over Ivory Cream with Gold Pinstripe -1409	Indian Motorcycle Red over Thunder Black with Gold Pinstripe -1412	Star Silver over Thunder Black with Gold Pinstripe -1477	Willow Green over Ivory Cream with Gold Pinstripe -1523	Steel Gray over Burgundy Metallic with Gold Pinstripe -1531	
Wildfire Red over Thunder Black with Gold Pinstripe -1535	Thunder Black over Ivory Cream with Gold Pinstripe -1544	Blue Sapphire over Star Silver with Gold Pinstripe -1559	Fireglow Red Candy over Thunder Black -1627	Polished Bronze over Thunder Black with Silver Pinstripe -1633	Pearl White over Star Silver with Black Pinstripe -1636	Metallic Jade over Thunder Black with Silver Pinstripe -1688	Ruby Metallic over Pearl White with Silver Pinstripe -1748	Dirt Track Smoke over Thunder Black Smoke with Gold Pinstripe -1751	
Deepwater Metallic over Dirt Track Tan with Silver Pinstripe -1761	Burnished Metallic over Sandstone Metallic with Gold Pinstripe -1768	Ruby Smoke over Thunder Black Smoke with Silver Pinstripe -1782	Steel Gray Smoke over Thunder Black Smoke with Silver Pinstripe -1783	Deepwater Metallic over Brilliant Blue with Silver Pinstripe -1821	Titanium Smoke over Thunder Black Smoke with Silver Pinstripe -1834	Coastal Green over Ivory Cream with Black Pinstripe -1838	Burgundy Metallic over Titanium Metallic with Gold Pinstripe -1870	Radar Blue over Pearl White with Silver Pinstripe -1883	
Pearl White over Titanium Metallic with Black Pinstripe -1886	Metallic Jade over Pearl White with Black Pinstripe -1888	Thunder Black Vivid Crystal over Wildfire Red Candy -1890	Maroon over Crimson Metallic -1930	Cruiser Black over Sands Metallic -1935	Arizona Turquoise over Pearl White -1951	Blue Slate Metallic Smoke over Flat Black -1953	Azure Crystal over Stealth Gray -1957	Alumina Jade over Cruiser Black -1960	

EXPLORE ALL OPTIONS / COLORS & GET A CUSTOMIZED QUOTE FROM YOUR DEALER

VISIT INDIANMOTORCYCLE.COM/BUILD

HARD LOWER FAIRINGS - CHIEFTAIN/ROADMASTER

2883984-729	NEW Dirt Track Smoke	\$929.99
2883984-800	NEW Black Metallic	\$929.99
2883984-834	NEW Stealth Gray Azure Crystal	\$929.99
2883984-866	NEW Black Smoke	\$929.99
2883984-869	NEW Silver Quartz Metallic	\$929.99
2883984-875	NEW Quartz Gray	\$929.99
2883984-266	Thunder Black	\$929.99
2883984-354	Star Silver	\$929.99
2883984-463	Thunder Black Smoke	\$929.99
2883984-581	Silver Smoke	\$1,339.99
2883984-601	Star Silver Smoke	\$929.99
2883984-620	Brilliant Blue	\$929.99
2883984-632	Titanium Smoke	\$929.99
2883984-639	Indian Motorcycle Red	\$929.99
2883984-640	Springfield Blue	\$929.99
2883984-666	Thunder Black Pearl	\$929.99
2883984-670	Willow Green	\$929.99
2883984-675	White Smoke	\$929.99

Fits 2014-2022 Chieftain models & Roadmaster models.

NEW

HARD LOWER FAIRINGS - INDIAN CHALLENGER

2889475-266	Thunder Black	\$929.99
2889475-293	Indy Red	\$929.99
2889475-463	Thunder Black Smoke	\$929.99
2889475-632	Titanium Smoke	\$929.99
2889475-666	Thunder Black Pearl	\$929.99
2889475-675	White Smoke	\$929.99
2889475-694	Spirit Blue Metallic	\$929.99
2889475-711	Maroon Metallic	\$929.99
2889475-727	Deepwater Metallic	\$929.99

Fits 2021-2022 Indian Challenger models.

QUICK RELEASE FAIRING - SCOUT

2884116-694	NEW Spirit Blue Metallic	\$1,099.99
2884116-800	NEW Black Metallic	\$1,099.99
2884116-849	NEW Storm Blue	\$1,099.99
2884116-853	NEW Riot Orange Metallic	\$1,099.99
2884116-866	NEW Black Smoke	\$1,099.99
2884116-869	NEW Silver Quartz Metallic	\$1,099.99
2884116-870	NEW Silver Quartz Smoke	\$1,099.99
2884116-875	NEW Quartz Gray	\$1,099.99
2884116-878	NEW Black Azure Crystal	\$1,099.99
2884116	Unpainted Part	\$799.99
2884116-266	Thunder Black	\$1,099.99
2884116-354	Star Silver	\$1,099.99
2884116-463	Thunder Black Smoke	\$1,099.99
2884116-493	Sunblaze Orange	\$1,099.99
2884116-517	Solar Flare Yellow	\$1,099.99
2884116-566	Pearl White	\$1,099.99
2884116-581	Silver Smoke	\$1,099.99
2884116-601	Star Silver Smoke	\$1,099.99
2884116-620	Brilliant Blue	\$1,099.99
2884116-629	Burgundy Metallic	\$1,099.99
2884116-639	Indian Motorcycle Red	\$1,099.99
2884116-646	Ivory Cream	\$1,099.99
2884116-653	Titanium Metallic	\$1,099.99

Fits 2015-2022 Scout models. Comes standard with 2 In. wind deflector. Bobber Light Relocation Kit (2884329) required to add to Scout Bobber.

DON'T LET SCRATCHES RUIN YOUR DAY.

See page 151 for Factory Original Touch-Up Paint.



2022

INTRO
2-11

FTR
12-27

SCOUT
28-51

INDIAN CHIEF
52-67

INDIAN SPRINGFIELD
68-91

CHIEFTAIN &
ROADMASTER
92-121

INDIAN CHALLENGER
122-135

POWERBAND AUDIO
136-139

COLOR-MATCHED
ACCESSORIES
140-143

GARAGE
144-151

eFTR
154-155

FULL ACCESSORY DETAILS AVAILABLE AT INDIANMOTORCYCLE.COM/ACCESSORIES

POWERBAND AUDIO SADDLEBAG SPEAKER LIDS

2883666-694	NEW Spirit Blue Metallic	\$529.99	2883666-675	White Smoke	\$529.99
2883666-711	NEW Maroon Metallic	\$529.99	2883666-685	Sagebrush Smoke	\$529.99
2883666-714	NEW Polished Bronze	\$529.99	2883666-692	Steel Gray	\$529.99
2883666-727	NEW Deepwater Metallic	\$529.99	2883666-724	Radar Blue	\$529.99
2883666-729	NEW Dirt Track Smoke	\$529.99	2883666-728	Ghost Gray	\$529.99
2883666-800	NEW Black Metallic	\$529.99	2883666-731	Bronze Smoke	\$529.99
2883666-834	NEW Stealth Gray Azure Crystal	\$529.99	2883666-740	Dragon Green	\$529.99
2883666-866	NEW Black Smoke	\$529.99	2883666-750	Burnt Orange Metallic	\$529.99
2883666-869	NEW Silver Quartz Metallic	\$529.99	2883666-756	Dark Walnut	\$529.99
2883666-875	NEW Quartz Gray	\$529.99	2883666-759	Ruby Metallic	\$529.99
2883666-878	NEW Black Azure Crystal	\$529.99	2883666-760	Ruby Smoke	\$529.99
2883666-266	Thunder Black	\$529.99	2883666-773	Sandstone Smoke	\$529.99
2883666-463	Thunder Black Smoke	\$529.99	2883666-804	Stealth Gray	\$529.99
2883666-620	Brilliant Blue	\$529.99	2883666-809	Azure Crystal	\$529.99
2883666-632	Titanium Smoke	\$529.99	2883666-819	Crimson Metallic	\$529.99
2883666-666	Thunder Black Pearl	\$529.99	2883666-823	Burnt Orange Metallic Smoke	\$529.99

Injection-molded lids are precision-engineered and manufactured like standard lids. They host PowerBand Audio 6 1/2 In. Amplified Speakers and Speaker Bezels, each sold separately. These lids replace standard lids. Color-matched with same premium finishes as standard lids. Install easily and fit perfectly. Fits 2019-2022 Chieftain models, 2020-2022 Indian Springfield Dark Horse, Roadmaster Dark Horse, Roadmaster Limited & Indian Challenger models.



POWERBAND AUDIO CLASSIC SADDLEBAG SPEAKER LIDS

2883670-266	Thunder Black	\$519.99	2883670-1783	Steel Gray Smoke over Thunder Black Smoke with Silver Pinstripe	\$669.99
2883670-463	Thunder Black Smoke	\$519.99	2883670-1821	Deepwater Metallic over Brilliant Blue with Silver Pinstripe	\$669.99
2883670-629	Burgundy Metallic	\$519.99	2883670-1834	Titanium Smoke over Thunder Black Smoke with Silver Pinstripe	\$669.99
2883670-675	White Smoke	\$519.99	2883670-1838	Coastal Green over Ivory Cream with Black Pinstripe	\$669.99
2883670-1523	Willow Green over Ivory Cream with Gold Pinstripe	\$669.99	2883670-1870	Burgundy Metallic over Titanium Metallic with Gold Pinstripe	\$669.99
2883670-1531	Steel Gray over Burgundy Metallic with Gold Pinstripe	\$669.99	2883670-1883	Radar Blue over Pearl White with Silver Pinstripe	\$669.99
2883670-1544	Thunder Black over Ivory Cream with Gold Pinstripe	\$669.99	2883670-1886	Pearl White over Titanium Metallic with Black Pinstripe	\$669.99
2883670-1633	Polished Bronze over Thunder Black with Silver Pinstripe	\$669.99	2883670-1888	Metallic Jade over Pearl White with Black Pinstripe	\$669.99
2883670-1636	Pearl White over Star Silver with Black Pinstripe	\$669.99	2883670-1930	Maroon over Crimson Metallic	\$669.99
2883670-1688	Metallic Jade over Thunder Black with Silver Pinstripe	\$669.99	2883670-1935	Cruiser Black over Sands Metallic	\$669.99
2883670-1748	Ruby Metallic over Pearl White with Silver Pinstripe	\$669.99	2883670-1951	Arizona Turquoise over Pearl White	\$669.99
2883670-1751	Dirt Track Smoke over Thunder Black Smoke with Gold Pinstripe	\$669.99	2883670-1953	Blue Slate Metallic Smoke over Flat Black	\$669.99
2883670-1761	Deepwater Metallic over Dirt Track Tan with Silver Pinstripe	\$669.99	2883670-1957	Azure Crystal over Stealth Gray	\$669.99
2883670-1768	Burnished Metallic over Sandstone Metallic with Gold Pinstripe	\$669.99	2883670-1960	Alumina Jade over Cruiser Black	\$669.99
2883670-1782	Ruby Smoke over Thunder Black Smoke with Silver Pinstripe	\$669.99			

Injection-molded lids are precision-engineered and manufactured like standard lids. They host PowerBand Audio 6 1/2 In. Amplified Speakers and Speaker Bezels, each sold separately. These lids replace the Classic Saddlebag Lids. Color-matched with same premium finishes as standard lids. Install easily and fit perfectly. Fits 2019-2022 Chieftain Classic, Indian Springfield models & Roadmaster models.



QUICK RELEASE

QUICK RELEASE TRUNK

2884046-729	NEW Dirt Track Smoke	\$1,849.99	2884046-756	Dark Walnut	\$1,849.99
2884046-800	NEW Black Metallic	\$1,849.99	2884046-759	Ruby Metallic	\$1,849.99
2884046-866	NEW Black Smoke	\$1,849.99	2884046-760	Ruby Smoke	\$1,849.99
2884046-869	NEW Silver Quartz Metallic	\$1,849.99	2884046-773	Sandstone Smoke	\$1,849.99
2884046-875	NEW Quartz Gray	\$1,849.99	2884046-804	Stealth Gray	\$1,849.99
2884046-266	Thunder Black	\$1,849.99	2884046-819	Crimson Metallic	\$1,849.99
2884046-463	Thunder Black Smoke	\$1,849.99	2884046-820	Blue Slate Metallic	\$1,849.99
2884046-581	Silver Smoke	\$1,849.99	2884046-823	Burnt Orange Metallic Smoke	\$1,849.99
2884046-601	Star Silver Smoke	\$1,849.99	2884046-1407	Springfield Blue over Ivory Cream with Gold Pinstripe	\$1,949.99
2884046-620	Brilliant Blue	\$1,849.99	2884046-1409	Indian Motorcycle Red over Ivory Cream with Gold Pinstripe	\$1,949.99
2884046-632	Titanium Smoke	\$1,849.99	2884046-1412	Indian Motorcycle Red over Thunder Black with Gold Pinstripe	\$1,949.99
2884046-639	Indian Motorcycle Red	\$1,849.99	2884046-1477	Star Silver over Thunder Black with Gold Pinstripe	\$1,949.99
2884046-640	Springfield Blue	\$1,849.99	2884046-1523	Willow Green over Ivory Cream with Gold Pinstripe	\$1,949.99
2884046-653	Titanium Metallic	\$1,799.99	2884046-1531	Steel Gray over Burgundy Metallic with Gold Pinstripe	\$1,949.99
2884046-666	Thunder Black Pearl	\$1,849.99	2884046-1535	Wildfire Red over Thunder Black with Gold Pinstripe	\$1,949.99
2884046-675	White Smoke	\$1,849.99	2884046-1544	Thunder Black over Ivory Cream with Gold Pinstripe	\$1,949.99
2884046-685	Sagebrush Smoke	\$1,849.99	2884046-1559	Blue Sapphire over Star Silver with Gold Pinstripe	\$1,949.99
2884046-692	Steel Gray	\$1,849.99	2884046-1627	Fireglow Red Candy over Thunder Black	\$2,999.99
2884046-724	Radar Blue	\$1,849.99	2884046-1688	Metallic Jade over Thunder Black with Silver Pinstripe	\$1,949.99
2884046-727	Deepwater Metallic	\$1,799.99	2884046-1761	Deepwater Metallic over Dirt Track Tan with Silver Pinstripe	\$1,949.99
2884046-728	Ghost Gray	\$1,849.99	2884046-1768	Burnished Metallic over Sandstone Metallic with Gold Pinstripe	\$1,949.99
2884046-731	Bronze Smoke	\$1,849.99	2884046-1888	Metallic Jade over Pearl White	\$1,949.99
2884046-740	Dragon Green	\$1,849.99	2884046-1890	Thunder Black Vivid Crystal over Wildfire Red Candy	\$3,599.99
2884046-750	Burnt Orange Metallic	\$1,799.99			

Fits 2014-2022 Chieftain models, Challenger models, Indian Springfield models. Standard on Roadmaster models.

CLASSIC HEADLIGHT BEZEL

2881770	Unpainted Part	\$104.99	2881770-646	Ivory Cream	\$154.99
2881770-266	Thunder Black	\$154.99	2881770-666	Thunder Black Pearl	\$154.99
2881770-354	Star Silver	\$154.99	2881770-670	Willow Green	\$154.99
2881770-447	Blue Diamond	\$154.99	2881770-675	White Smoke	\$159.99
2881770-463	Thunder Black Smoke	\$154.99	2881770-692	Steel Gray	\$154.99
2881770-566	Pearl White	\$154.99	2881770-706	Steel Gray Smoke	\$154.99
2881770-581	Silver Smoke	\$154.99	2881770-714	Polished Bronze	\$154.99
2881770-598	Blue Sapphire	\$154.99	2881770-727	Deepwater Metallic	\$154.99
2881770-601	Star Silver Smoke	\$154.99	2881770-729	Dirt Track Tan	\$154.99
2881770-620	Brilliant Blue	\$159.99	2881770-731	Bronze Smoke	\$154.99
2881770-629	Burgundy Metallic	\$154.99	2881770-754	Burnished Metallic	\$154.99
2881770-639	Indian Motorcycle Red	\$154.99	2881770-759	Ruby Metallic	\$154.99
2881770-640	Springfield Blue	\$154.99	2881770-760	Ruby Smoke	\$154.99

Fits 2014-2018 Chieftain models, 2014-2021 Chieftain Classic & 2015-2022 Roadmaster.



OPEN FRONT FENDER

2882761	Unpainted Part	\$309.99	2882761-670	Willow Green	\$499.99
2882761-266	Thunder Black	\$499.99	2882761-675	White Smoke	\$499.99
2882761-354	Star Silver	\$499.99	2882761-676	Wildfire Red	\$499.99
2882761-463	Thunder Black Smoke	\$499.99	2882761-692	Steel Gray	\$499.99
2882761-566	Pearl White	\$499.99	2882761-724	Radar Blue	\$499.99
2882761-581	Silver Smoke	\$499.99	2882761-729	Dirt Track Smoke	\$499.99
2882761-598	Blue Sapphire	\$499.99	2882761-731	Bronze Smoke	\$619.99
2882761-601	Star Silver Smoke	\$499.99	2882761-740	Dragon Green	\$619.99
2882761-629	Burgundy Metallic	\$499.99	2882761-745	Metallic Jade	\$499.99
2882761-632	Titanium Smoke	\$499.99	2882761-750	Burnt Orange Metallic	\$619.99
2882761-639	Indian Motorcycle Red	\$499.99	2882761-753	Coastal Green	\$499.99
2882761-640	Springfield Blue	\$499.99	2882761-754	Burnished Metallic	\$499.99
2882761-665	Patriot Red Pearl	\$499.99	2882761-756	Dark Walnut	\$619.99
2882761-666	Thunder Black Pearl	\$499.99	2882761-759	Ruby Metallic	\$619.99

Recommended with 19 In. 10-Spoke Front Wheel (part numbers vary) or Precision Machined Front Wheel (2884426-266W), each sold separately. Fits 2014-2022 Chieftain models, Roadmaster & Indian Springfield models. Standard on Chieftain Limited & Indian Springfield Dark Horse.



2022

INTRO

2-11

FTR

12-27

SCOUT

28-51

INDIAN CHIEF

52-67

INDIAN SPRINGFIELD

68-91

CHIEFTAIN & ROADMASTER

92-121

INDIAN CHALLENGER

122-135

POWERBAND AUDIO

136-139

COLOR-MATCHED ACCESSORIES

140-143

GARAGE

144-151

eFTR

154-155



Indian Motorcycle Lubricants are engineered specifically to provide unmatched protection and performance in both air cooled and liquid cooled motorcycle engines. Our formulas are designed to resist high heat and thermal breakdown, keep the engine clean to maximize horsepower and protect gear and transmission components while providing optimum clutch and shifting characteristics. After-market oils are generally produced to fit a wide variety of brands, engine sizes and transmission configurations. Indian Motorcycles invests millions in engine development, including testing each and every lubricant we produce, in field validation and engine dynamometer testing, to ensure we have the highest quality of oils and lubricants available for your Indian Motorcycle.

20W-40 SEMI-SYNTHETIC ENGINE OIL

2880012 Quart
2880013 Drum – 55 Gallons
2884065 330 Gallon Tote

Approved for use in all Thunderstroke air cooled Indian Motorcycle engines. High heat shear stability, engine wear protection and enhanced clutch wear protection. Not compatible with Indian Challenger models.



15W-60 FULL SYNTHETIC ENGINE OIL

2880187 Quart
2880188 Drum – 55 Gallons
2884083 330 Gallon Tote

Indian 15W-60 is approved for use in all air cooled and liquid cooled Indian Motorcycle engines. Our wide viscosity range custom motorcycle specific additive system smooths shift effort, enhances clutch feel for positive shift engagement and reduces clutch wear. Full synthetic base stock and advanced API SN category formulation improves high temperature deposit protection for maximum power and reduced piston and cam wear. Extended 10k mile oil change interval on all Scout engines.



INDIAN CARBON CLEANER

2881911 12 fl oz.

Total fuel system cleaner. Stabilized fuel for up to 2 years. Removes carbon deposits from injectors, valves, piston rings and combustion chamber.



FORK OIL

2208093 Type I, 1 Quart*
2884244 Type II, 1 Quart**

Developed with a high viscosity index to resist shear, foaming, heat and internal shock wear.
*Compatible with all Indian Motorcycles except Indian Challenger models.
**Compatible with Indian Challenger models.



50/50 PREMIX EXTENDED LIFE ANTI-FREEZE

2880966 1 Quart

Advanced extended life coolant designed for use in all liquid cooled Indian motorcycles.



OIL FILTER

2520799*
2521421**

*Compatible with Indian Scout models.
**Compatible with 2014 and newer Thunderstroke and PowerPlus engines.



THUNDERSTROKE OIL CHANGE KIT

2880067 5.5 Quarts – 20W-40 Semi Synthetic Motor Oil

Contains: 1 oil filter (2521421) and 2 washers. Compatible with Thunderstroke air cooled engines from 2018 and older. 2019 engines, see dealer for capacity. 2020-2022 engines require 6 quarts of engine oil.



INDIAN SCOUT OIL CHANGE KIT

2880191 4 Quarts – 15W-60 Full Synthetic Motor Oil

Contains: 1 oil filter (2520799), and 2 washers. Compatible with all Indian Scout model engines.



INDIAN CHALLENGER OIL CHANGE KIT

2884171 5 Quarts – 15W-60 Full Synthetic Motor Oil

Contains: 1 oil filter (2521421) and 1 washer. Compatible with the PowerPlus engine.



FTR OIL CHANGE KIT

2884182 4 Quarts – 15W-60 Full Synthetic Engine Oil

Contains: 1 oil filter (2540086) and 2 drain plug washers. Compatible with Indian FTR models.



DOT-4 BRAKE FLUID

2880016 12 fl oz.

DOT-4 Brake Fluid maintains viscosity over a wide temperature range. Designed for use in all Indian motorcycles, including ABS systems.



SYNTHETIC CHAIN LUBE

2884172 11 oz.

Advanced anti-wear and corrosion protection system designed for on-road and off-road motorcycles. Compatible with FTR models.



15W-60 RETRO 4-PK OIL KIT

2830497 4 Quarts

Limited edition retro 4 pack 15W-60 synthetic oil can kit. Each kit consists of 4 retro steel quart cans filled with Indian 15W-60 Synthetic Engine Oil, packaged in a unique woodgrain crate-look carton.



2022

INTRO
2-11

FTR
12-27

SCOUT
28-51

INDIAN CHIEF
52-67

INDIAN SPRINGFIELD
68-91

CHIEFTAIN &
ROADMASTER
92-121

INDIAN CHALLENGER
122-135

POWERBAND AUDIO
136-139

COLOR-MATCHED
ACCESSORIES
140-143

GARAGE
144-151

eFTR
154-155

SERVICE PARTS

INDIAN MOTORCYCLE ENGINEERED SERVICE PARTS DELIVER UNMATCHED PERFORMANCE AND FIT FOR YOUR MOTORCYCLE.

All service parts are developed and tested for your vehicle. Electrical components, clutching components, fenders and decals are the same parts that are manufactured on the factory lines for each specific model. This ensures it doesn't merely fit your motorcycle – it outperforms your expectations!

SHOP FOR SERVICE PARTS ONLINE OR VISIT YOUR INDIAN MOTORCYCLE DEALER.

CHECK OUT OUR PARTS FINDER ON INDIANMOTORCYCLE.COM FOR EASY PARTS LOOK-UP, PARTS IDENTIFICATION, VIEWS OF ASSEMBLIES & MORE!

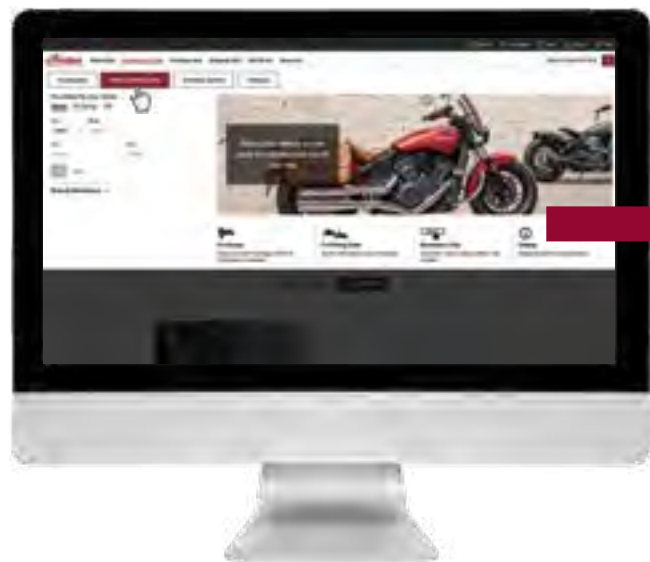

STEP 1

Visit indianmotorcycle.com
Click "Accessories & Parts" tab
Click "Parts & Maintenance"



STEP 2

Enter vehicle year/model or shop by part number



STEP 3

Clearly see what parts are required and order

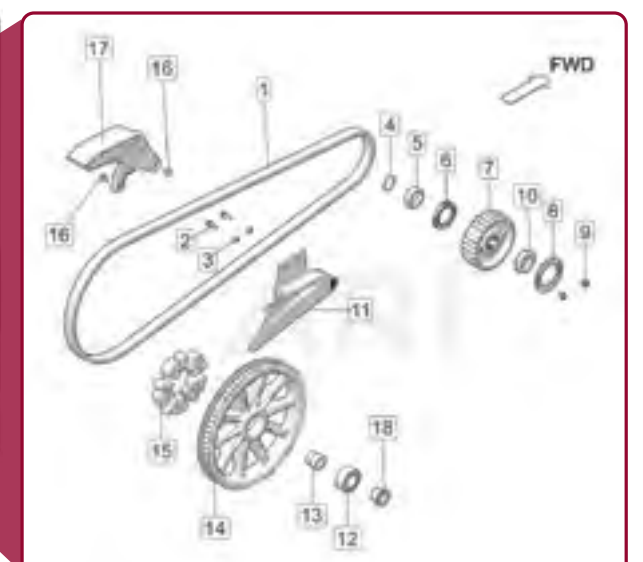

**OVER
100,000 PARTS
AVAILABLE!**



2022

INTRO
2-11

FTR
12-27

SCOUT
28-51

INDIAN CHIEF
52-67

INDIAN SPRINGFIELD
68-91

CHIEFTAIN &
ROADMASTER
92-121

INDIAN CHALLENGER
122-135

POWERBAND AUDIO
136-139

COLOR-MATCHED
ACCESSORIES
140-143

GARAGE
144-151

eFTR
154-155



FOR THE LIFE OF YOUR RIDE



2022

NOCO®

- **All-in-one solution:** Battery charger, battery maintainer, trickle charger, plus battery desulfator.
- **Enjoy precision charging:** An integrated thermal sensor detects the ambient temperature and alters the charge to eliminate over-charging in hot climates and under-charging in cold climates.
- **Charge dead batteries:** Charges batteries as low as 1-volt. Or use the all-new force mode that allows you to take control and manually begin charging dead batteries down to zero volts.
- **Restore your battery:** Automatically detects battery sulfation and acid stratification to restore lost battery performance for stronger engine starts and extended battery life.
- **Beyond maintenance:** It's not just a trickle charger, it's an advanced battery maintainer. A fully-automatic, worry-free battery charger for everyday use - 24/7 - with zero overcharge.
- **Includes Boost Eyelet Cable with X-Connector Adapter (2830546)**



NEW
NOCO® BATTERY CHARGER - 1 AMP
2830567 \$64.99



NEW
NOCO® BATTERY CHARGER - 2 AMP
2830568 \$99.99



1,000 AMP ULTRASAFE LITHIUM JUMP PACK
2830547 \$124.99



JUMP PACK PROTECTION CASE
2830548 \$18.99

MAINTENANCE SCHEDULE

BREAK-IN MAINTENANCE

- ENGINE OIL & FILTER:** CHANGE & REPLACE
- DRIVE BELTS:** INSPECT & ADJUST TENSION
INSPECT FOR WEAR OR DAMAGE
REPLACE AS NEEDED
- FRONT FORK OIL:** INSPECT
REPLACE AS NEEDED

2,500 MILES

- ENGINE OIL:** CHECK LEVEL
- AIR FILTER:** INSPECT
REPLACE AS NEEDED
- DRIVE BELTS:** INSPECT & ADJUST TENSION
INSPECT FOR WEAR OR DAMAGE
REPLACE AS NEEDED

5,000 MILES

- ENGINE OIL:** CHANGE
THUNDERSTROKE MODELS
- AIR FILTER:** INSPECT
REPLACE AS NEEDED
- DRIVE BELTS:** INSPECT & ADJUST TENSION
INSPECT FOR WEAR OR DAMAGE
REPLACE AS NEEDED
- FRONT FORK OIL:** INSPECT
REPLACE AS NEEDED

10,000 MILES

- ENGINE OIL:** CHANGE
ALL MODELS
- AIR FILTER:** INSPECT
REPLACE AS NEEDED
- DRIVE BELTS:** INSPECT & ADJUST TENSION
INSPECT FOR WEAR OR DAMAGE
REPLACE AS NEEDED
- FRONT FORK OIL:** INSPECT
REPLACE AS NEEDED

15,000 MILES

- ENGINE OIL:** CHANGE
- AIR FILTER:** REPLACE
- SPARK PLUGS:** INSPECT
REPLACE AS NEEDED
- DRIVE BELTS:** INSPECT & ADJUST TENSION
INSPECT FOR WEAR OR DAMAGE
REPLACE AS NEEDED
- FRONT FORK OIL:** REPLACE

CHECK YOUR OWNER'S MANUAL FOR ADDITIONAL RECOMMENDED SERVICE ITEMS AND VEHICLE-SPECIFIC TIMING.

BATTERIES

To ensure a battery maintains its level of charge when unused for extended periods of time or during freezing weather, the battery should be connected to a NOCO® Battery Charger (see P. 148). Be sure to check for corrosion from the terminals to the ends of the cables.

SPARK PLUGS

New spark plugs, engineered specifically for your Indian Motorcycle, ensure quick starts, fuel efficiency and peak performance.

BRAKE PADS

Maintaining and/or replacing brakes is critical to the safety and functionality of a motorcycle. Brake pads should be checked for wear and oil or grease (petroleum products) contamination. Brake discs should be checked for cracks, excessive corrosion or warping.

TIRES

Inspecting and replacing tires when needed is critical to the safety and functionality of a motorcycle.

OIL FILTER

Change oil filters with every oil change to provide the best engine protection and keep the engine operating at peak performance.

AIR FILTER

A clogged air filter can restrict air flow to the engine leading to reduced engine performance, engine life or catastrophic failure.

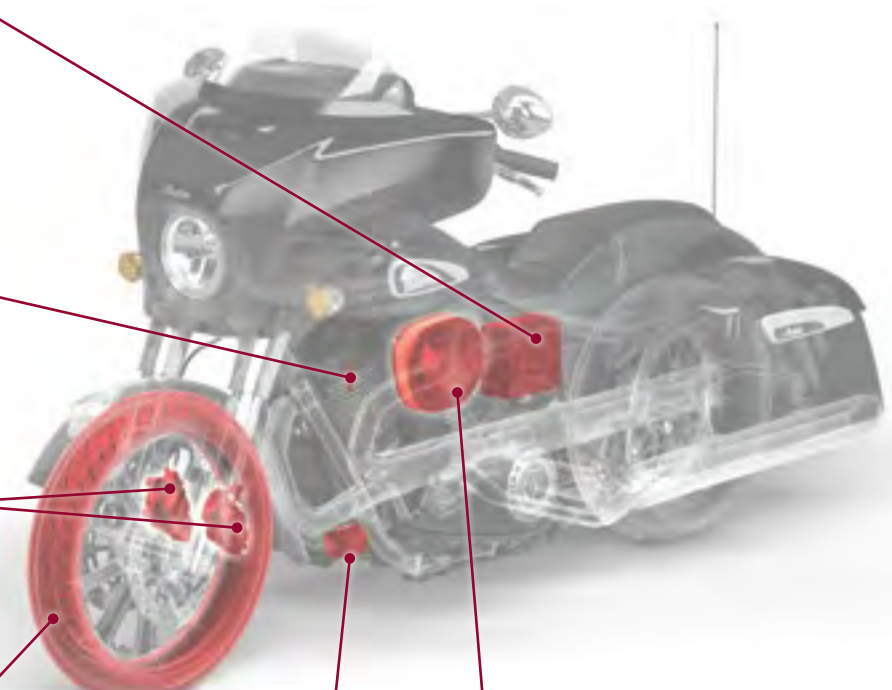

INTRO
2-11

FTR
12-27

SCOUT
28-51

INDIAN CHIEF
52-67

INDIAN SPRINGFIELD
68-91

CHIEFTAIN & ROADMASTER
92-121

INDIAN CHALLENGER
122-135

POWERBAND AUDIO
136-139

COLOR-MATCHED ACCESSORIES
140-143

GARAGE
144-151

eFTR
154-155

INDIAN CHIEF COVERS

- A. 2883886 All-Weather Cover* \$179.99
- B. 2883891 Dust Cover \$179.99
- C. 2883892 Half Cover \$59.99
- D. 2883893 Travel Cover \$59.99

Fits 2014-2021 Indian Chief, Chief Classic, Vintage, Chief Dark Horse & 2022 Indian Springfield models.

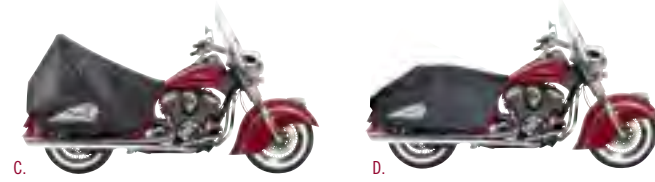

TOURING COVERS

- A. 2883896 Half Cover \$69.99
- B. 2889367 Travel Cover \$79.99
- C. 2889365 All-Weather Cover* \$179.99
- D. 2889366 Soft Cover \$169.99

Fits 2014-2022 Chieftain models, Roadmaster models & Indian Springfield models. Compatible with Trunk Mounted Antenna (2889596), sold separately.



SCOUT COVER

- 2883887 All-Weather Cover* \$179.99

Fits 2014-2022 Scout models.



CHIEFTAIN COVERS

- A. 2883888 All-Weather Cover* \$179.99
- B. 2883889 Dust Cover** \$179.99
- C. 2883890 Travel Cover \$79.99

Fits 2014-2022 Chieftain models.

**Compatible with Trunk Mounted Antenna (2889596), sold separately.

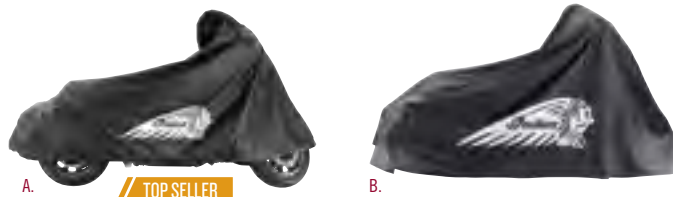

INDIAN CHALLENGER COVERS

- A. 2884459 Travel Cover* \$79.99
- B. 2884460 All-Weather Cover* \$159.99
- C. 2883889 Dust Cover \$179.99

Fits 2020-2022 Indian Challenger models.



SEAT COVER

- 2883894 \$39.99

Fits model year 2014-2022.



GARAGE DOOR OPENER

- 2882132 \$169.99

Fits 2017-2022 Chieftain models, Roadmaster models & Indian Challenger models.



PORTABLE POWER

FLEX JUMPSTARTER

- 2830530 \$99.99

The Flex Jumpstarter is the perfect companion for any Indian Motorcycle ride. Flex is small enough to store in your saddlebag, holds its charge so you can count on it when it's needed, and it doubles as a flashlight.

Includes:

- 8,000 mAh Lithium Jump Starter
- Thermoform Carrying Case
- Micro USB Charging Cable
- Jumper Cables
- Battery Maintainer Cable

Fits all Indian motorcycles, as well as any engine up to 4.6 L.



INDIAN MOTORCYCLE TOUCH UP PAINT

- | | | |
|----------------|---------------|-------------------|
| Paint Pen | 2859080-XXXXI | \$13.99 - \$44.99 |
| 12 oz. Aerosol | 2859078-XXXXI | \$24.99 - \$74.99 |
| Quart | 2859079-XXXXI | See Dealer |

Factory Original Touch-Up Paint. All kits contain 1-3 separate paint components. XXX in part numbers ties to a paint color code. See your dealer or www.indianmotorcycle.com/accessories for more information.



FLUID FUNNEL

- 2830552 \$12.99

Easily add oil with high accuracy.



FLUID SYRINGE

- 2830553 \$29.99

Easily add and remove fluid from your vehicle.



FLUID TRAY

- 2830551 \$19.99

Holds up to 8 quarts of fluid.



INDIAN MOTORCYCLE MAGNETIC PARTS TRAY

- 2830433 \$5.99



INDIAN MOTORCYCLE 3-POSITION GARAGE CREEPER

- 2830456 \$129.99



2022

INTRO
2-11

FTR
12-27

SCOUT
28-51

INDIAN CHIEF
52-67

INDIAN SPRINGFIELD
68-91

CHIEFTAIN &
ROADMASTER
92-121

INDIAN CHALLENGER
122-135

POWERBAND AUDIO
136-139

COLOR-MATCHED
ACCESSORIES
140-143

GARAGE
144-151

eFTR
154-155



HASSLE FREE MAINTENANCE FOR YOUR MOTORCYCLE

Service at all participating Indian Motorcycle dealerships in the US and Canada

Factory trained technicians & Genuine Indian Motorcycle parts

No deductible

Transferable to the next owner

A simple solution to keep you riding

Prepay to protect against rising costs

VISIT INDIANMOTORCYCLE.COM/PREMIUMCARE OR SEE YOUR DEALER FOR MORE INFORMATION



2022

INTRO
2-11

FTR
12-27

SCOUT
28-51

INDIAN CHIEF
52-67

INDIAN SPRINGFIELD
68-91

CHIEFTAIN & ROADMASTER
92-121

INDIAN CHALLENGER
122-135

POWERBAND AUDIO
136-139

COLOR-MATCHED ACCESSORIES
140-143

GARAGE
144-151

eFTR
154-155

COVERAGE LEVELS

PREMIUM CARE

(Available on New & Pre-Owned Indian Motorcycles)

3 YEARS / 4 VISITS OR
5 YEARS / 6 VISITS

COVERED SERVICES:

- Engine Oil & Filter Change
- Multi-Point Inspection

ADDITIONAL BENEFITS:

- Roadside Assistance
- 5% Off All Parts & Accessories

PREMIUM CARE PLUS

3 YEARS / 5 VISITS / 0-15,000 MILES OR
5 YEARS / 7 VISITS / 0-25,000 MILES

COVERED SERVICES:

All regular maintenance in owner's manual including but not limited to:

- Engine Oil & Filter Change
- Front Fork Oil Change
- Air Filter Replacement
- Brake Fluid Change
- Test Ride to Ensure Performance
- Multi-Point Inspection (including 2,500 mile inspection)

ADDITIONAL BENEFITS:

- Roadside Assistance
- 10% Off All Parts & Accessories

TERMS & CONDITIONS

- Non-cancellable after 60 days.
- Serviceable at all participating Indian Motorcycle dealerships in the US or Canada.
- Check for dealer participation before scheduling services.
- Does not cover wear items. This is not a warranty program.

FOR PROGRAM QUESTIONS CALL YOUR INDIAN MOTORCYCLE DEALER OR 1-877-204-3697.

PROVIDED AND ADMINISTERED BY INDIAN MOTORCYCLE.

eFTR YOUTH ELECTRIC BIKES



2022

INTRO
2-11

FTR
12-27

SCOUT
28-51

INDIAN CHIEF
52-67

INDIAN SPRINGFIELD
68-91

CHIEFTAIN &
ROADMASTER
92-121

INDIAN CHALLENGER
122-135

POWERBAND AUDIO
136-139

COLOR-MATCHED
ACCESSORIES
140-143

GARAGE
144-151

eFTR
154-155



NEW

eFTR MINI

2889573 | \$499.99

The eFTR Mini is the ideal way to introduce youngsters to the joy of motorsports while supervising adults enjoy the peace of mind of managing the bike's maximum power. This electric bike has a speed switch a supervising adult can adjust between top speeds of 14 mph (high) and 10 mph (low). It also has: a twist grip throttle, durable steel tube frame, speed mode switch, hand-operated rear brake for confidence-inspiring control, and a long-range battery. This bike is for riders age 8 and up, and maximum rider weight for this bike is 140 lb.

	eFTR MINI	eFTR JR
HIGH SPEED	14 MPH (Ages 13+)	15 MPH (Ages 14+)
LOW SPEED	10 MPH (Ages 8+)	10 MPH (Ages 8+)
SEAT HEIGHT	18.4 in. (468 mm)	23.2 in. (589 mm)
SUSPENSION	Rigid Frame	Front & Rear
BRAKES	Rear	Front & Rear
MOTOR	350W	500W
BATTERY	24V	36V
RUN TIME	30 Minutes	65 Minutes

eFTR JR

2884726 | \$799.99

Young riders can enjoy the exciting Flat Track racing experience on this eFTR JR with styling designed to match the Indian Motorcycle Racing FTR750 Flat Track race bike, the same championship winning motorcycle ridden by the Indian Wrecking Crew. Designed for riders ages 8+ and up to 175 pounds (79 kg), the eFTR JR is powered by an electric motor with a rechargeable battery. This bike has a durable frame with front & rear suspension, folding metal foot pegs, chain drive, adjustable riser-style handlebar, twist throttle, and a hand-operated dual-disc brake.



eFTR JR HELMET - BLACK
2860226 | S-XL
\$69.99



eFTR JR RACING LONG SLEEVE TEE - BLACK/RED
2860225 | S-XL
\$29.99



eFTR JR GLOVE - BLACK
2860224 | S-XL
\$24.99



eFTR JR ARMOR - BLACK
2860223 | S-XL
\$99.99

FULL DETAILS AVAILABLE AT [INDIANMOTORCYCLE.COM/ACCESSORIES](https://www.IndianMotorcycle.com/accessories)



OUTPOST

CLOTHING, GIFTS & GEAR

Visit your local dealer or Indianmotorcycle.com/apparel to see the full line of clothing, gifts & gear.



HELMETS



CASUALWEAR



JACKETS



FOOTWEAR



HOME & GIFTS



2022

INTRO
2-11

FTR
12-27

SCOUT
28-51

INDIAN CHIEF
52-67

INDIAN SPRINGFIELD
68-91

CHIEFTAIN &
ROADMASTER
92-121

INDIAN CHALLENGER
122-135

POWERBAND AUDIO
136-139

COLOR-MATCHED
ACCESSORIES
140-143

GARAGE
144-151

eFTR
154-155



2022

INTRO
2-11

FTR
12-27

SCOUT
28-51

INDIAN CHIEF
52-67

INDIAN SPRINGFIELD
68-91

CHIEFTAIN &
ROADMASTER
92-121

INDIAN CHALLENGER
122-135

POWERBAND AUDIO
136-139

COLOR-MATCHED
ACCESSORIES
140-143

GARAGE
144-151

eFTR
154-155

BUILD YOUR DREAM INDIAN MOTORCYCLE

VISIT INDIANMOTORCYCLE.COM/BUILD

Hundreds of Accessories to Choose From
Explore All Models and Colors
Get a Customized Quote from Your Dealer

1 CHOOSE MODEL



2 CHOOSE TRIM & COLOR



3 CHOOSE ACCESSORIES



Always wear a helmet, protective eyewear and clothing and insist your passenger does the same. Ride within the limits of the law and your own abilities. Read and understand your owner's manual. Never ride under the influence of drugs or alcohol. Indian Motorcycle strongly recommends riders take a Motorcycle Safety Foundation® Rider Course. For a course near you, call 1-800-446-9227. Protect riders' rights by joining the American Motorcycle Association. For the name of your nearest Indian Motorcycle dealer, call 1-800-POLARIS or go to polarisindustries.com. Polaris Sales Inc. reserves the right without prior notice to discontinue at any time at its discretion any of the items herein or change specifications or designs without incurring any obligation to the customer. All items are subject to availability and prior sales by our dealers. Catalog design by SAGA Marketing. Printed in the USA.

Unless noted, trademarks are the property of Indian Motorcycle International, LLC. Akrapovič® is a registered trademark of Igor Akrapovic. Apple CARPLAY®, Apple® and iPhone® are registered trademarks of Apple Inc. Bluetooth® is a registered trademark of Bluetooth Sig, Inc. Nacelle® is a registered trademark of Woven Technology LLC. FOX® is a registered trademark of Fox Factory Inc. NOCO® and NOCO GENIUS® are registered trademarks of The Noco Company. Öhlins® is a registered trademark of Öhlins Racing AB CORPORATION SWEDEN. ProTaper® is a registered trademark of Lacy Distribution, Inc. Razor® is a registered trademark of Razor USA LLC. RIZOMA® is a registered trademark of RIZOMA S.R.L. RoadLoK® is a registered trademark of New Hampton Technologies, LLC dba RoadLoK Security. Roland Sands Design® is a registered trademark of Roland Sands Design, Inc. SAE™ is a service mark of Society of Automotive Engineers, Inc. Pirelli®, Metzeler® and Scorpion® are registered trademarks of PIRELLI TYRE S.P.A. Velcro® is a registered trademark of Velcro BVDA. X-GRIP® and RAM® are registered trademarks of National Products, Inc. Prices, fitment and availability are subject to change at any moment. Copyright © 2021 Indian Motorcycle International, LLC. All rights reserved.

⚠️ Performance parts are 50 state emissions compliant. Non-competition street use on motorcycles subject to USEPA noise limits & may violate federal noise limits. Indian Motorcycle recognizes the importance of environmental laws that regulate exhaust and noise emissions and is committed to developing performance parts that allow motorcycle enthusiasts to modify their vehicles in a safe and responsible manner. Emissions / Safety: Federal and many state laws prohibit the removal, modification, or rendering inoperative any part installed on motor vehicles by Indian Motorcycle affecting emissions or safety on motor vehicles manufactured for use on a public street or highway. Violation may result in fines. International markets, please consult your local laws for additional information. Noise: Certain Indian Motorcycle performance parts are subject to noise-related usage restrictions. The warning statement for these parts includes the statement, "On road use of this product may violate federal law." These products are designed for use on closed course motorcycles only and do not conform to U.S. EPA noise emission standards. Use on motorcycles subject to EPA noise regulations constitutes tampering and is a violation of Federal law unless it can be shown that such use does not cause the motorcycle to exceed applicable Federal Standards.



PREMIUM CARE

**THE ONLY FACTORY
AUTHORIZED PREPAID
MAINTENANCE PLAN FOR
YOUR INDIAN MOTORCYCLE**

TO LEARN MORE GO TO PAGE 152,
INDIANMOTORCYCLE.COM/PREMIUMCARE
OR VISIT YOUR LOCAL DEALER



PART #: 9952428

2022 INDIAN ACCESSORY CATALOG-US

© 2021 Indian Motorcycle International, LLC