

CF Moto Uforce 1000 Glass Windshield



Product Instructions | Part No: 28900

Application: CF Moto Uforce 1000, verify accessory fitment at Kolpin.com.

Before You Begin: Read these instructions and check to be sure all parts and tools are accounted for. Please retain these installation instructions for future reference and parts ordering information.

Note: If any hardware is missing, do not return to the store. Call us to help, Toll Free 1-877-956-5746.

Note: Two people are required to install this Windshield Kit.

Items marked (*) are included in Hardware Kit PN 28901.

Items marked (**) are included in Hardware Kit PN 28091.

This Kit includes:

Item	Qty	Part Description
1	1	Uforce 1000 Glass Windshield
2*	4	Button Screw, Zinc Plated, M6 x 1.25 - 20mm LG
3*	4	Flat Washer, Zinc Plated, M6
4*	4	Lock Washer, Zinc Plated, M6
5*	4	Clamp, Painted, Profile Tube
6**	2	Thumbscrew Knob, M6-1.0 thread
7*	1	Bulb Trim Seal
8**	2	Small Lock Washer, Zinc Plated
9**	2	Small Flat Washer, Zinc Plated
10	1	Instruction Guide (not shown)

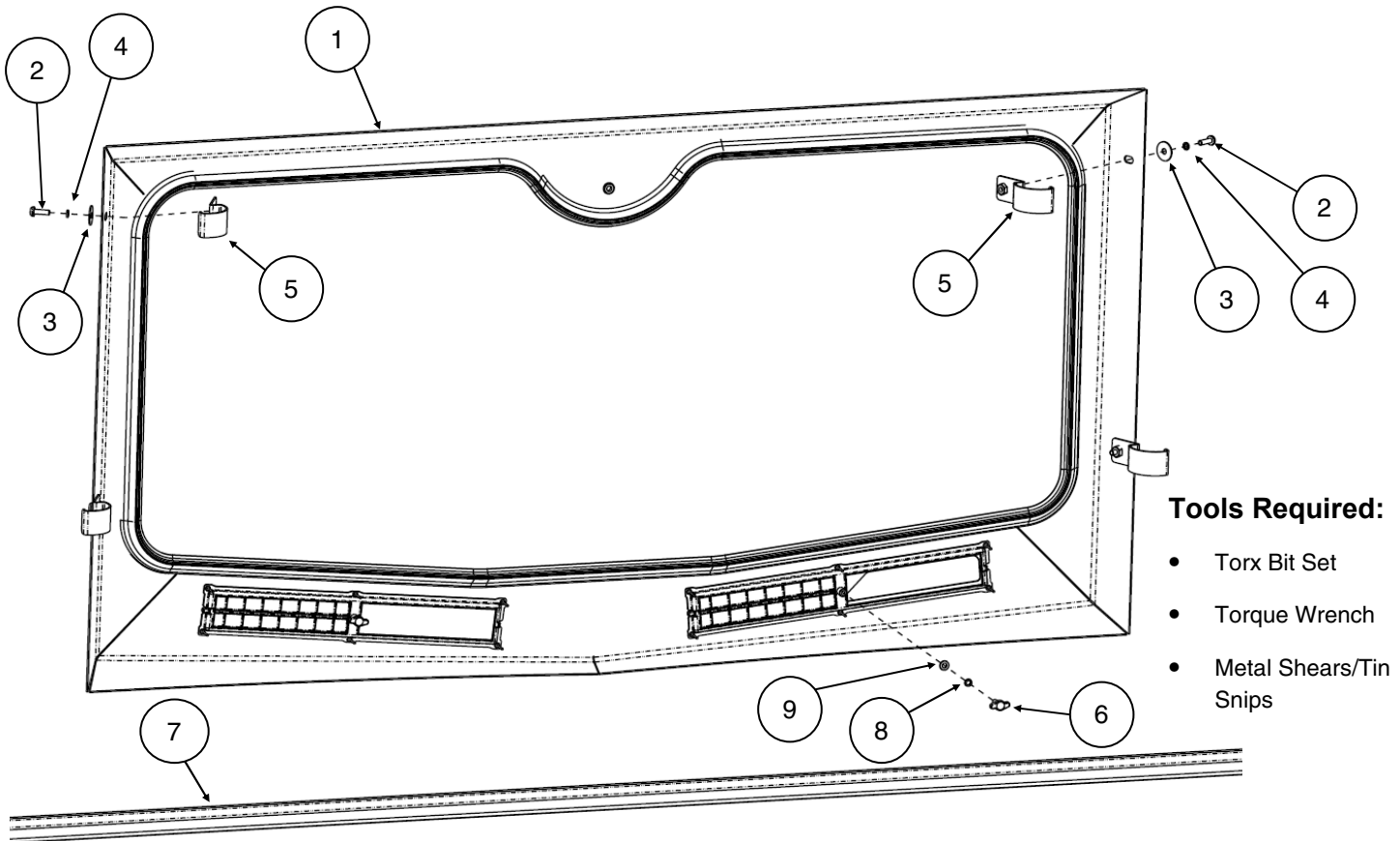

Tools Required:

- Torx Bit Set
- Torque Wrench
- Metal Shears/Tin Snips

Kolpin Outdoors, Inc. | 9955 59th Ave N | Plymouth, MN 55442

(877) 956-5746 or (763) 478-5800 | www.kolpin.com | customerservice@kolpin.com

Assembly Time: Approximately 18 minutes

Important: Your Kolpin Glass Windshield Kit is exclusively designed for your vehicle. Please read the installation instructions thoroughly before beginning. Installation is easier if the vehicle is clean and free of debris. For your safety, and to ensure a satisfactory installation, perform all installation steps correctly in the sequence shown. For better cab assembly procedure, install kits in the following order: front window, rear window, and roof.

Installation Instructions:

1. Shift vehicle transmission into "PARK". Turn key to "OFF" position and remove from vehicle.
2. By firmly pressing with hand, install the bulb trim seal (item #7) onto the formed edge surface of the glass windshield (item #1) as shown, applying around the perimeter. Trim seal ends to match up with location as shown. (See illustrations 1-1, 1-2 and 1-3).

Note: *The bulb trim seal has metal retainer strip, recommended cutting tool is metal shears/tin snips.*

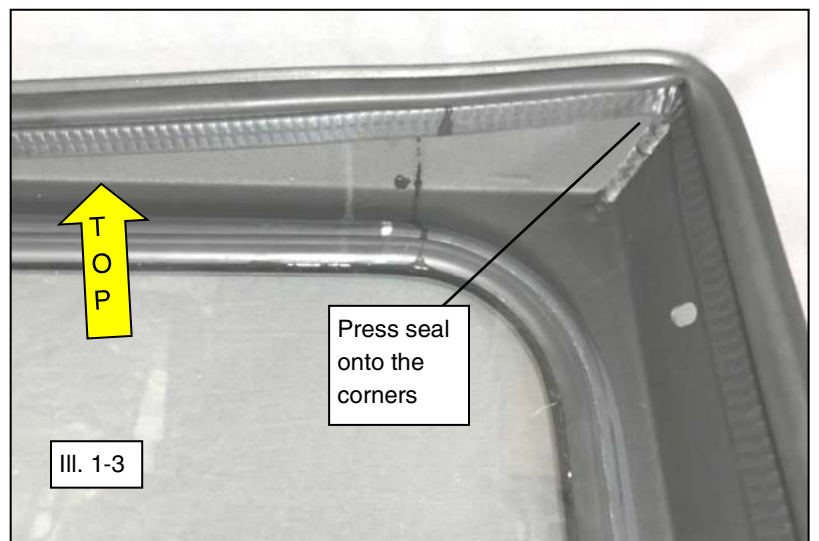
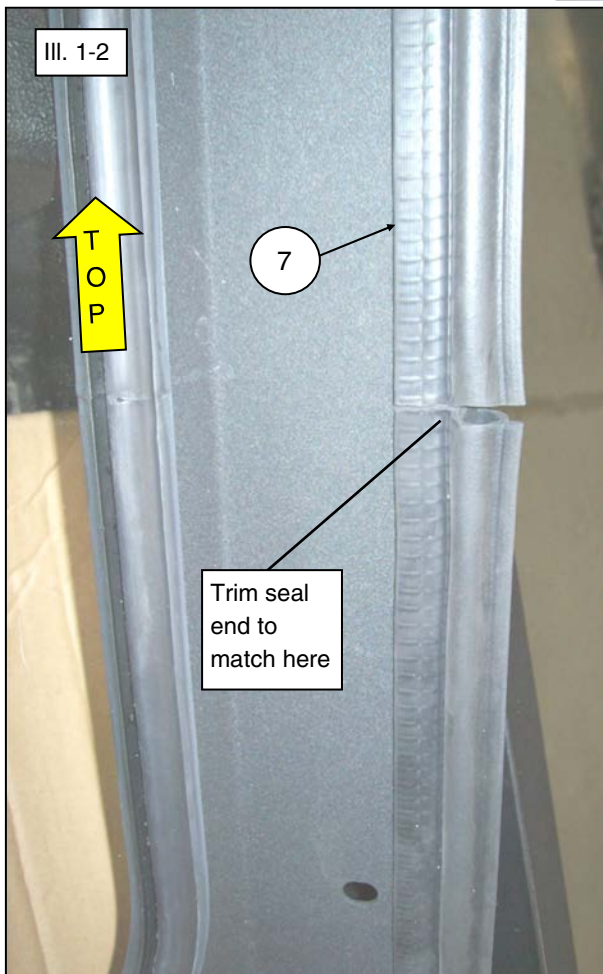
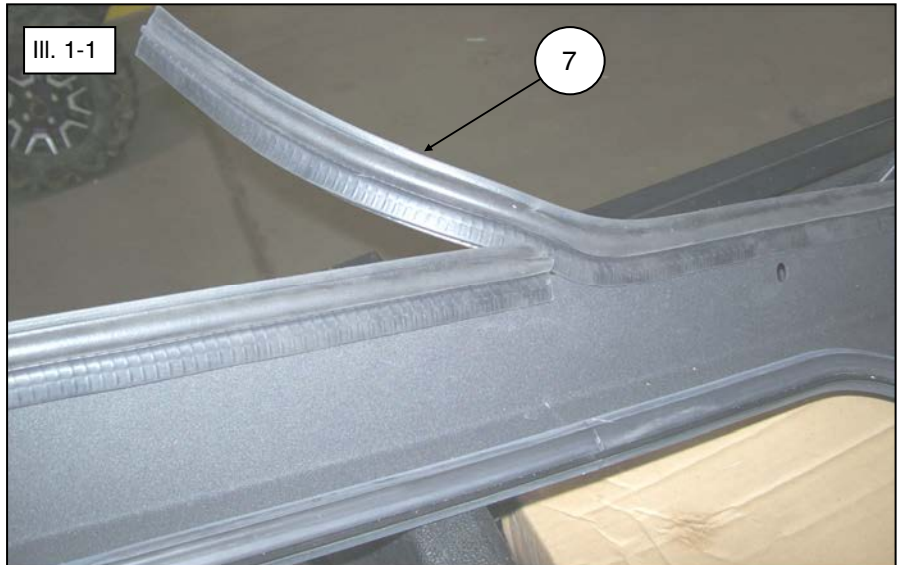

Installation Instructions (Continued):

- Place the windshield assembly into the vehicle cab frame ROPS, aligning the top edge with the visor and bottom edge with the dash as shown. (See illustrations 1-4 and 1-7).
- Center the windshield into the cab frame and then from rear windshield surface, place clamps (item #5) around cab frame tubes as shown. (See illustrations 1-5 and 1-6). **Note, you can align the clamps onto the ROPS tubing by looking through the slotted hole on glass windshield, then rotate and apply force to clip the clamp into position.**

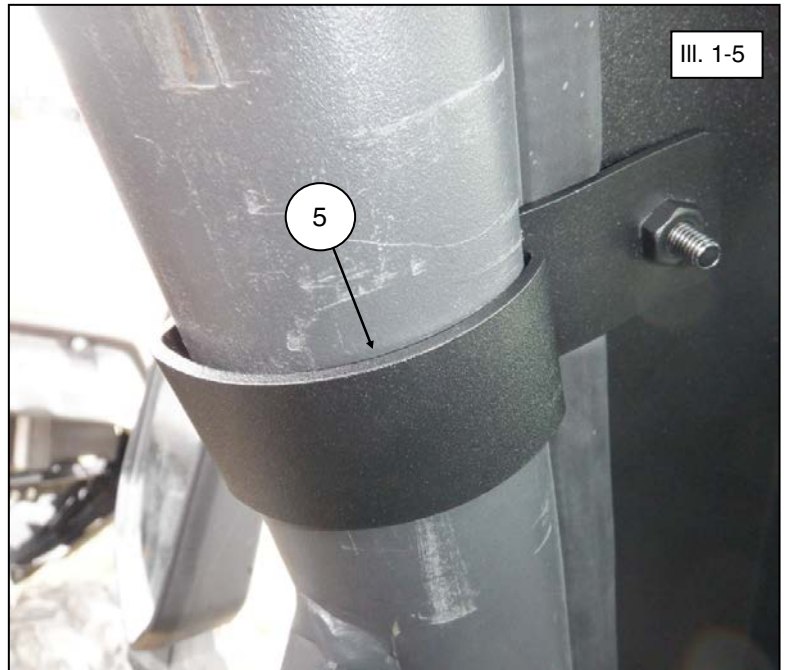
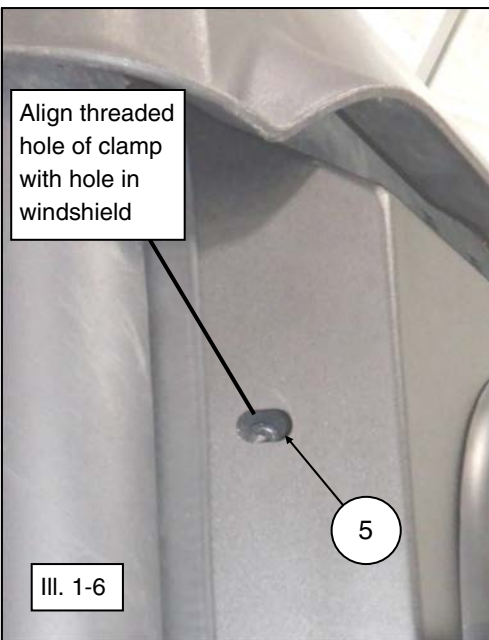
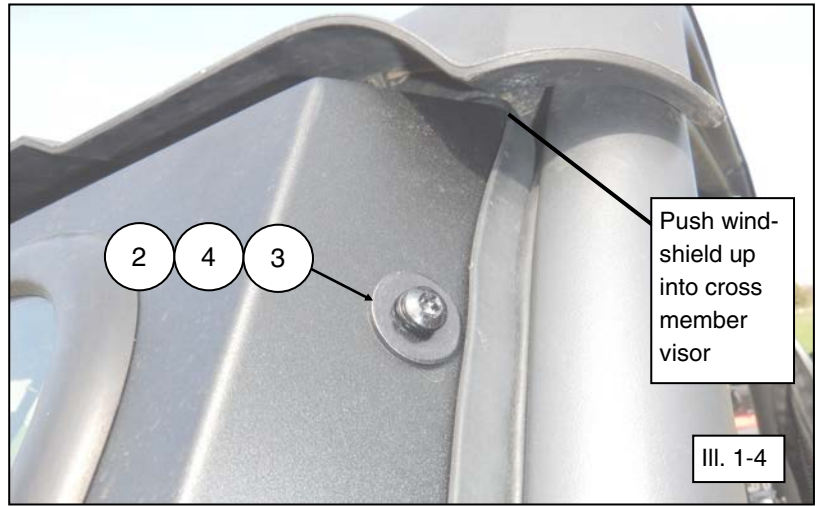

- From the front windshield surface, insert M6 screws (item #2) thru M6 lock washer (item #4) and M6 washer (item #3) and then thru each of the four slotted hole locations as shown. (See illustrations 1-4, 1-7 and 1-8).
- Tighten all hardware to specification.

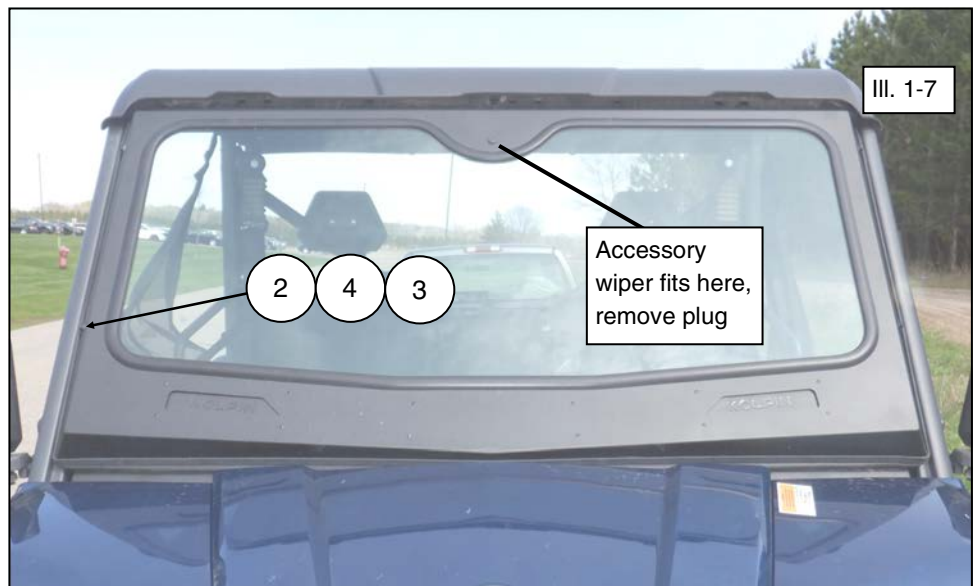

= T
6MM FASTENER TORQUE: 7 ft. lbs. (9.5 Nm)

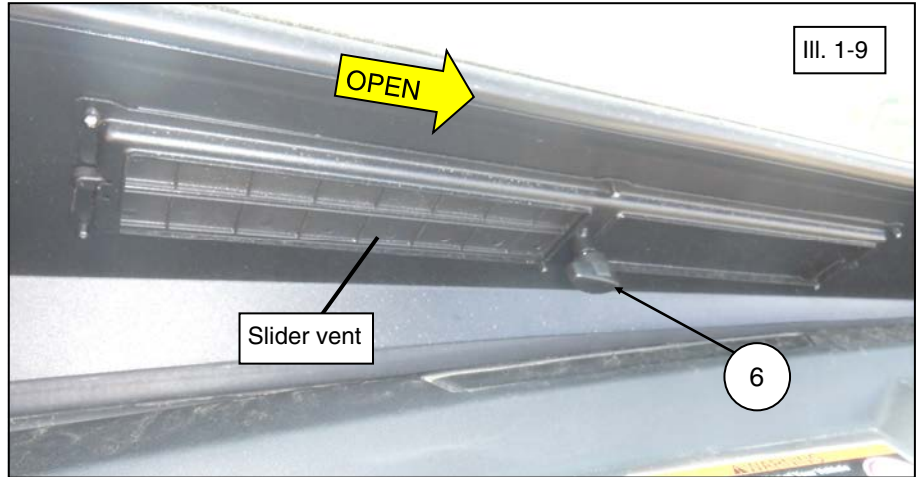
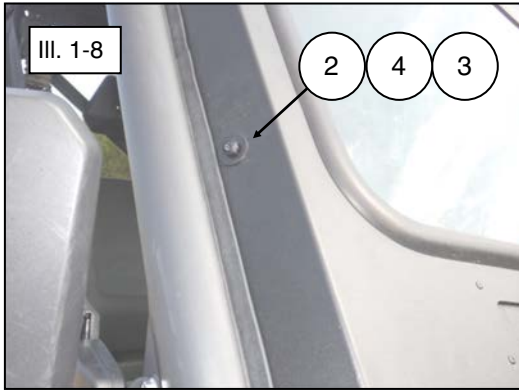

Slide Vent Operation:

- To open slider vents, slightly loosen the thumbscrew knob (item #6) and move plastic slider as desired in direction shown, then snugly retighten thumbscrew. (See illustration 1-9). **Note: Make sure thumbscrew knob is always snugly tight, do not overtighten.**

WARNING: If transporting vehicle in non-enclosed trailer then vehicle must FACE FORWARD, or windshield must be removed.

Failure to comply may allow airflow, vibration, or other factors to separate windshield from vehicle and cause an accident, resulting in serious personal injury or death.

Spare Kit PN 28090: Windshield Vent Slide - Single
(Includes plastic slider, metal frame, thumbscrew, flat washer, lock washer, six rivets)

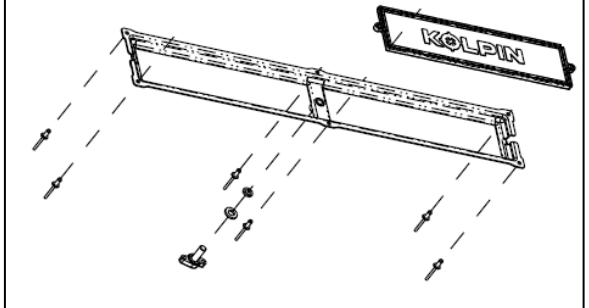

Use and Care Information:

- Check the accessory mounts frequently and retighten hardware if necessary.
- Replace this accessory with a new one if it is damaged.
- Never use petroleum solvents such as gasoline, thinner, benzene, acid or alkaline cleaners.

For additional assistance, please contact Kolpin customer service department at (877) 956-5746 or (763) 478-5800 or email customerservice@kolpin.com

One Year Limited Warranty

For the period of one (1) year from the purchase date, Kolpin will replace for the original purchaser, free of charge, any part or parts found upon examination by Kolpin to be defective in material, workmanship, or both.

All transportation costs incurred submitting product to Kolpin for warranty consideration must be borne by the purchaser. If Kolpin determines that the product must be returned to the factory for credit, please call 1-877-956-5746 for a Return Merchandise Authorization (RMA) number and shipping instructions.

This warranty does not apply to parts that have been damaged by accident, alteration, abuse, improper maintenance, normal wear, or other causes beyond the manufacturer's control. In order to protect you and your ATV, certain parts of the accessory system and/or hardware are designed to fail when the equipment is over-stressed. Parts that are lost due to loosening and improper maintenance are not covered under warranty. This warranty does not cover removal or reinstallation labor fees of the plow system and related components.

Peripheral products such as engines, electric motors, and actuators may carry an original manufacturer's warranty. Most hardware is general in nature and is easily obtained locally. Be sure to replace with minimum metric class 8.8 specification.