

Polaris RZR Metal Roof

Product Instructions | Part No: 29100 Steel
(29105 Aluminum)

Application: Verify accessory fitment at Kolpin.com.

Before You Begin: Read these instructions and check to be sure all parts and tools are accounted for. Please retain these installation instructions for future reference and parts ordering information.

Note: If any hardware is missing, do not return to the store. Call us to help, Toll Free 1-877-956-5746.

This Kit includes:

Item	Qty	Part Description
1	1	RZR Roof
2*	2	Button Screw, Zinc Plated, M6 x 1.0 - 35mm LG
3*	7	Flat Washer, Zinc Plated, M6
4*	7	Flange Locknut, Zinc Plated, M6-1.0
5*	3	Clamp, Painted, 1.75" Diameter
6*	5	Button Screw, Zinc Plated, M6 x 1.0 - 20mm LG
7*	3	Foam Strip
8	1	Instruction Guide (not shown)

Items marked (*) are included in Hardware Kit PN 29101.

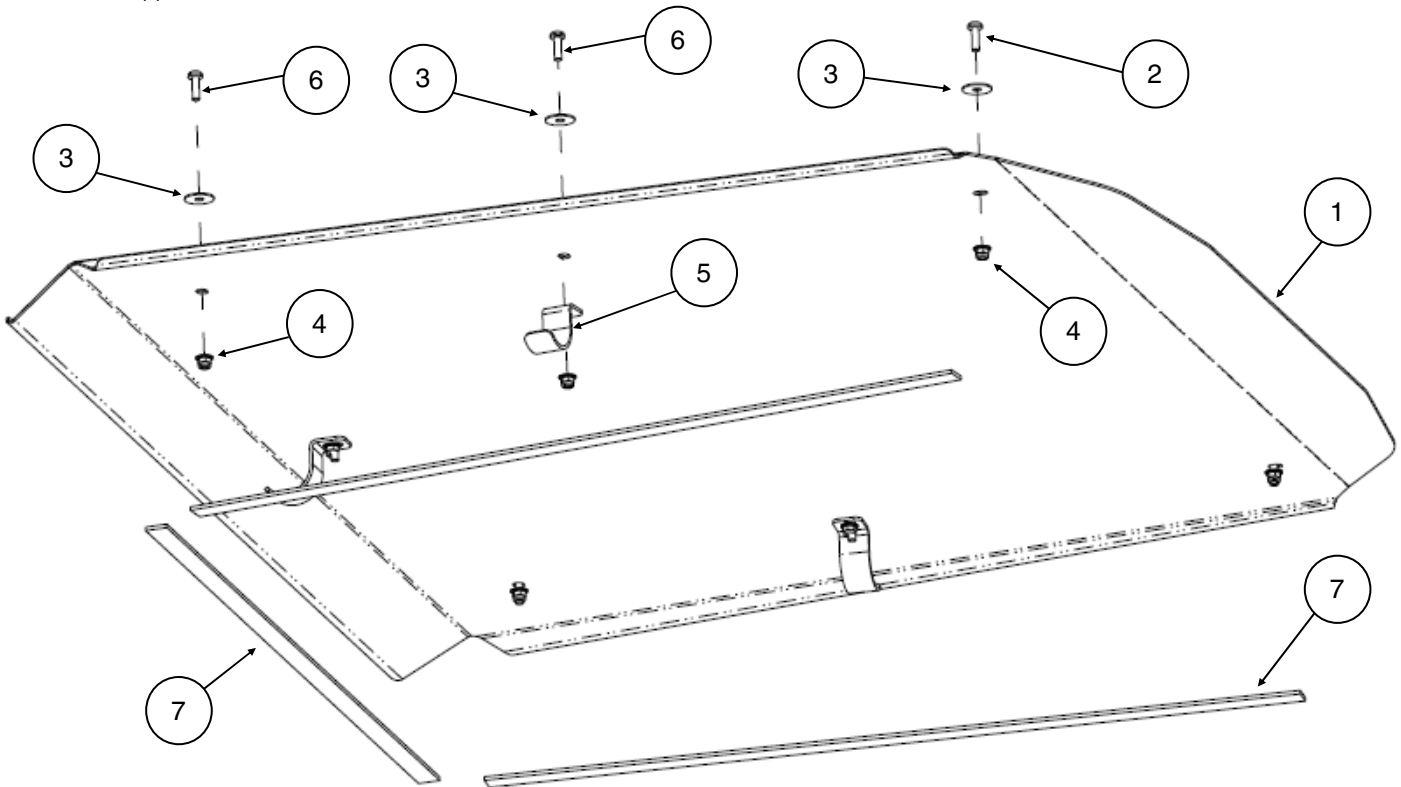

Tools Required:

- Socket Set, Metric
- Torx Bit Set
- Utility Knife/Cutting Tool
- Wrench Set, Metric
- Torque Wrench

Kolpin Outdoors, Inc. | 9955 59th Ave N | Plymouth, MN 55442
(877) 956-5746 or (763) 478-5800 | www.kolpin.com | customerservice@kolpin.com

Assembly Time: Approximately 15 minutes

Important: Your Kolpin Roof Kit is exclusively designed for your vehicle. Please read the installation instructions thoroughly before beginning. Installation is easier if the vehicle is clean and free of debris. For your safety, and to ensure a satisfactory installation, perform all installation steps correctly in the sequence shown.

Installation Instructions:

1. Shift vehicle transmission into "PARK". Turn key to "OFF" position and remove from vehicle.
2. Remove two OEM screws from upper rear side of visor as shown. The OEM screws will not be reused. (See illustration 1-1). **Note: Do not remove two screws from lower front side of visor. Roof (item #1) will be installed on top of visor.**

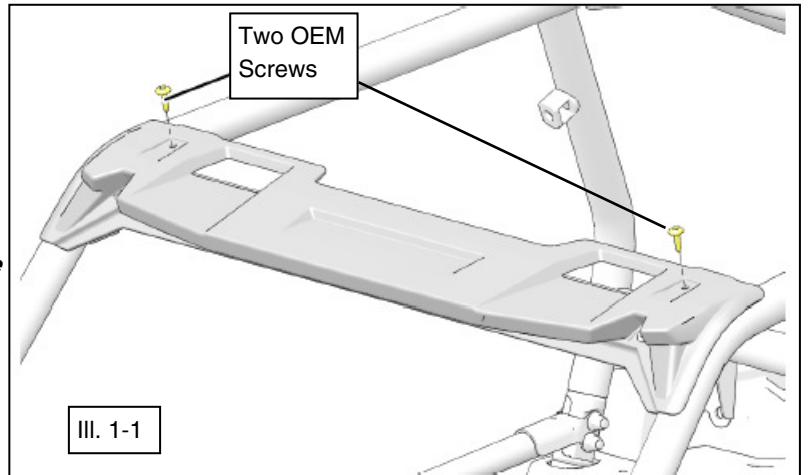

3. Remove the two nut clips on outer flanges of front cab frame as shown. The OEM nut clips will not be reused. (See illustration 1-2).

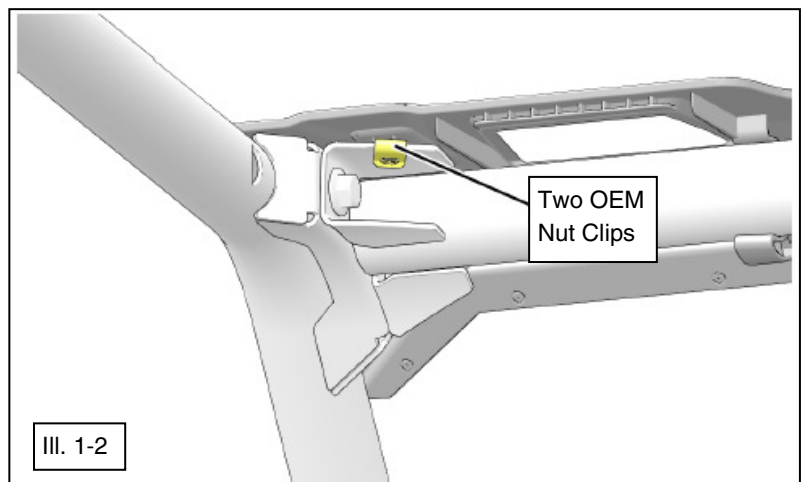

Installation Instructions (Continued):

4. Clean lower surface of roof (item #1) as required, then apply foam strips (item #7) as shown. Trim seals as required. (See illustration 1-3). **Note: You can position roof on top of cab frame, aligning front roof holes with the screw holes removed from visor, then mark with tape or pencil where the cab frame tubes match with lower roof surface. The alignment marks help locate where the foam strips will be applied.**
5. Loosely install front of roof (item #1) using two of the longer M6 screws (item #2) and flat washers (item #3) as shown. (See illustration 1-4).
6. From underneath roof, loosely fasten front screws with two M6 locknuts (item #4). **Note: Do not tighten hardware at this step since adjustments may be required later.**

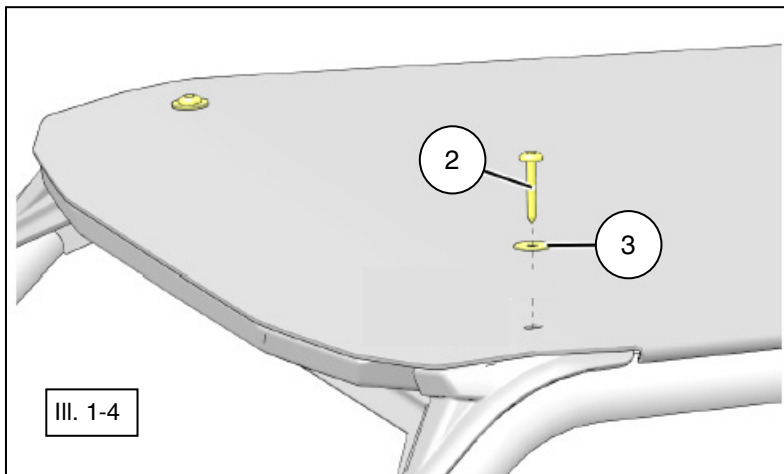
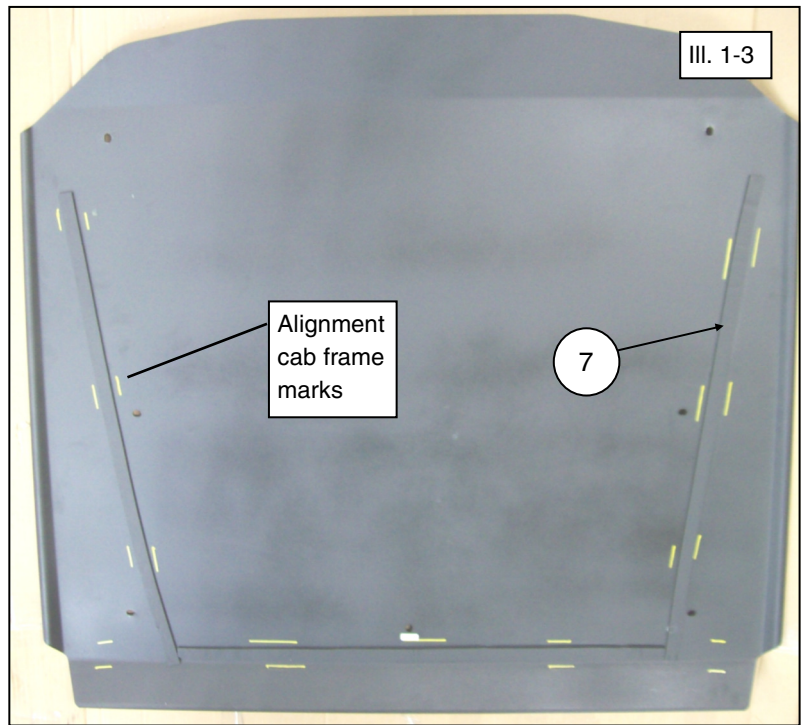

7. Install rear of roof using two of the shorter M6 screws (item #6) and flat washers (item #3) fitting thru outer flanges of rear cab frame.
8. Loosely fasten the rear screws using two locknuts (item #4) as shown. (See illustration 1-5). **Note: Do not tighten hardware at this step since adjustments may be required later.**

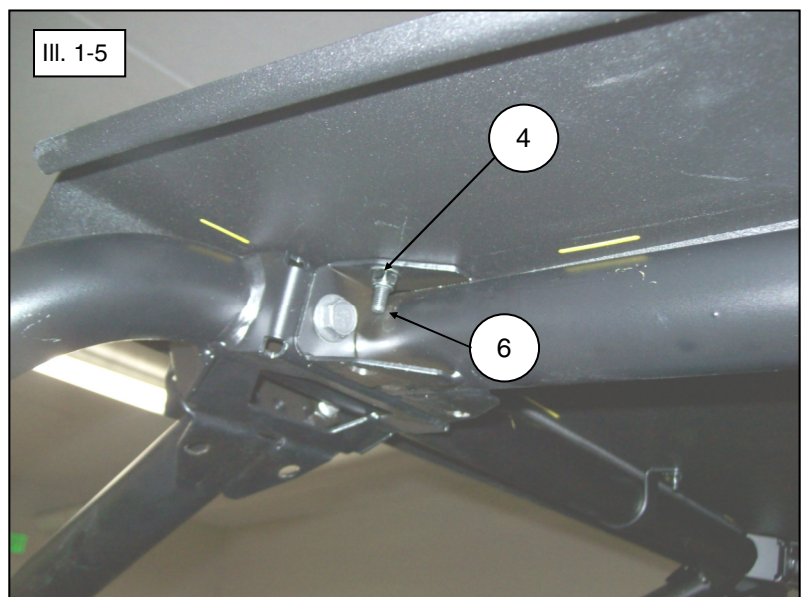

Installation Instructions (Continued):

- Attach the remaining two sides and the center of the rear with the shorter M6 screws (item #6) and flat washers (item #3) passing thru roof holes. Place clamps (item #5) around cab frame tubes and fasten with locknuts (item #4) as shown. (See illustration 1-6).
- Tighten all hardware to specification.

 = T
6MM FASTENER TORQUE: 7 ft. lbs. (9.5 Nm)

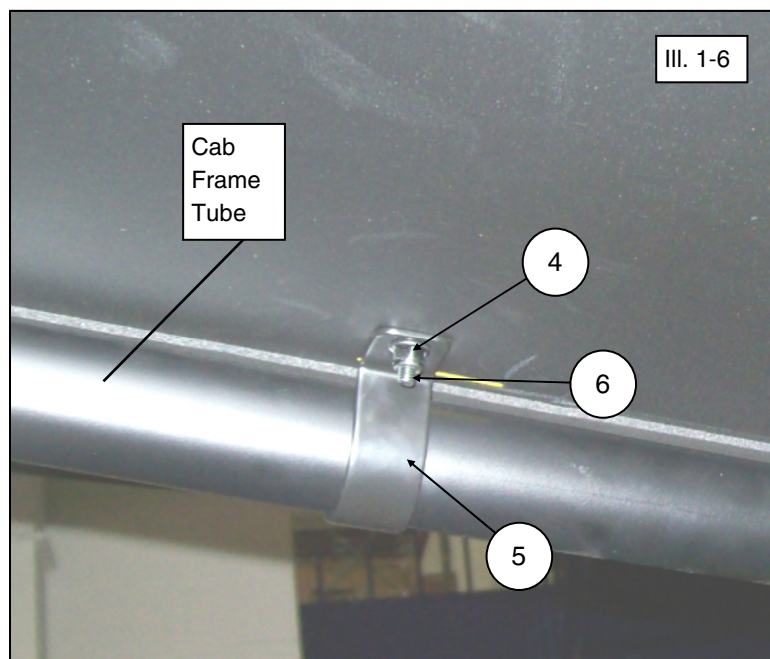

Use and Care Information:

- Check the accessory mounts frequently and retighten hardware if necessary.
- Replace this accessory with a new one if it is damaged.
- Never use petroleum solvents such as gasoline, thinner, benzene, acid or alkaline cleaners.

For additional assistance, please contact Kolpin customer service department at (877) 956-5746 or (763) 478-5800 or email customerservice@kolpin.com

One Year Limited Warranty

For the period of one (1) year from the purchase date, Kolpin will replace for the original purchaser, free of charge, any part or parts found upon examination by Kolpin to be defective in material, workmanship, or both.

All transportation costs incurred submitting product to Kolpin for warranty consideration must be borne by the purchaser. If Kolpin determines that the product must be returned to the factory for credit, please call 1-877-956-5746 for a Return Merchandise Authorization (RMA) number and shipping instructions.

This warranty does not apply to parts that have been damaged by accident, alteration, abuse, improper maintenance, normal wear, or other causes beyond the manufacturer's control. In order to protect you and your ATV, certain parts of the accessory system and/or hardware are designed to fail when the equipment is over-stressed. Parts that are lost due to loosening and improper maintenance are not covered under warranty. This warranty does not cover removal or reinstallation labor fees of the plow system and related components.

Peripheral products such as engines, electric motors, and actuators may carry an original manufacturer's warranty. Most hardware is general in nature and is easily obtained locally. Be sure to replace with minimum metric class 8.8 specification.