

Can-Am Defender MAX

Steel Roof



Product Instructions | Part No: 29420

Application: Can-Am Defender MAX, verify accessory fitment at Kolpin.com.

Before You Begin: Read these instructions and check to be sure all parts and tools are accounted for. Please retain these installation instructions for future reference and parts ordering information.

Note: If any hardware is missing, do not return to the store. Call us to help, Toll Free 1-877-956-5746.

Note: Two people are required to install this Roof Kit.

Items marked (*) are included in Hardware Kit PN 29421.

This Kit includes:

Item	Qty	Part Description
1	1	Defender MAX Front Roof Panel
2	1	Defender MAX Rear Roof Panel
3*	5	Button Screw, Zinc Plated, M6 x 1.0 - 25mm LG
4*	5	Flat Washer, Zinc Plated, M6
5*	4	Button Screw, Zinc Plated, M8-1.25 x 35mm LG
6*	4	Flat Washer, Zinc Plated, M8
7*	4	Flange Locknut, Zinc Plated, M8-1.25
8*	2	Front / Rear Foam Strip, 53" (1350mm) length
9*	2	Front Side Foam Strip, 26.5" (675mm) length
10*	1	Bulb Trim Seal
11*	1	Rubber Overlap Trim Seal
12*	5	Clamp, Painted, 2.0" Diameter
13*	5	Flange Locknut, Zinc Plated, M6-1.0
14*	2	Rear Side Foam Strip, 38.5" (975mm) length
15*	2	Cross-member Foam Strip, 54.5" (1380mm) length
16	1	Instruction Guide (not shown)

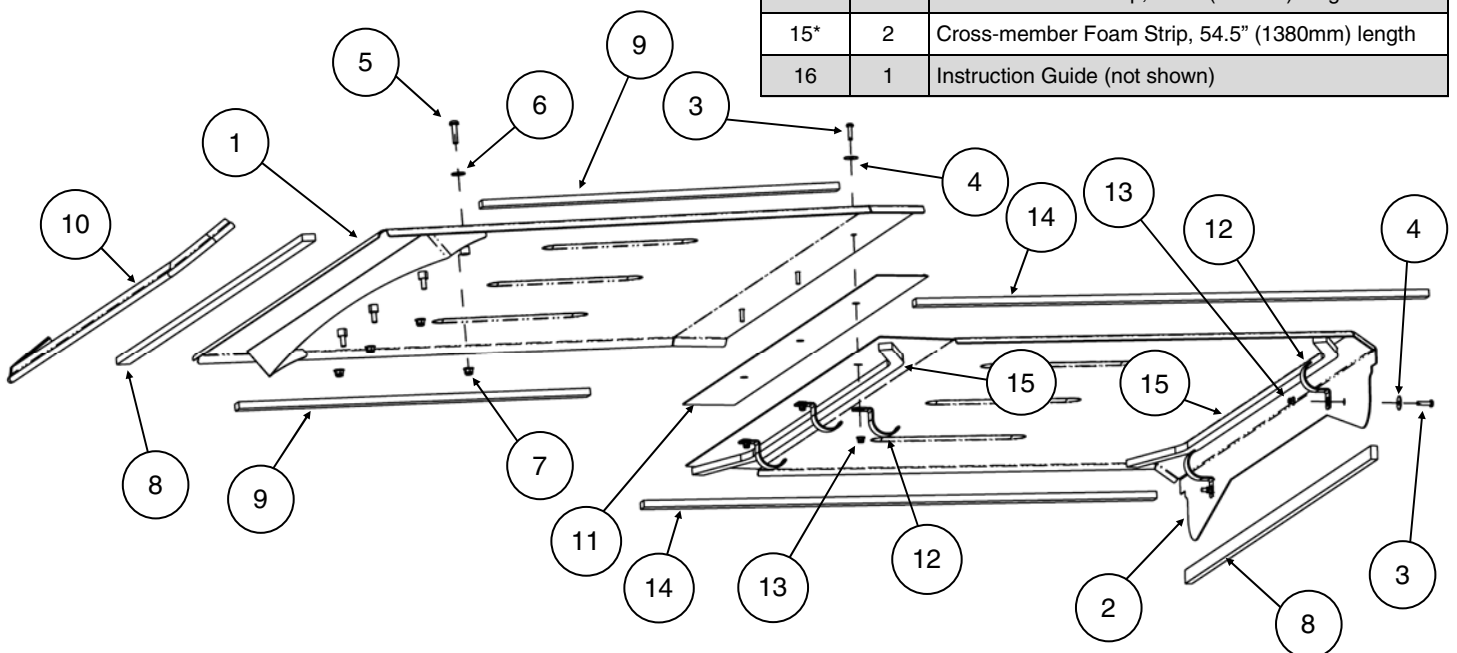

Tools Required:

- Socket Set, Metric
- Torx Bit Set
- Utility Knife/Cutting Tool
- Wrench Set, Metric
- Torque Wrench
- Metal Shears/Tin Snips

Kolpin Outdoors, Inc. | 9955 59th Ave N | Plymouth, MN 55442

(877) 956-5746 or (763) 478-5800 | www.kolpin.com | customerservice@kolpin.com

Assembly Time: Approximately 20 minutes

Important: Your Kolpin Steel Roof Kit is exclusively designed for your vehicle. Please read the installation instructions thoroughly before beginning. Installation is easier if the vehicle is clean and free of debris. For your safety, and to ensure a satisfactory installation, perform all installation steps correctly in the sequence shown. For better cab assembly procedure, install kits in the following order: front window, rear window, and roof.

Installation Instructions:

1. Shift vehicle transmission into "PARK". Turn key to "OFF" position and remove from vehicle.
2. Being careful to not scratch painted surfaces, place the front steel roof panel (item #1) onto rear steel roof panel (item #2). Fasten panels together by using three M6 screws (item #3) and three M6 washers (item #4) inserting through the outer holes at the overlapping seam. Loosely secure with M6 locknuts (item #13) on underside roof surface. (See illustrations 1-1 and 1-2). **Note, place rubber seal (item #11) in between the two roof panels as shown. Do not tighten hardware at this step since adjustments may be required later.**
3. Install the bulb trim seal (item #10) onto the front lower surface of the front roof panel (item #1) as shown. Trim seal as required. (See illustration 1-3). **Note: The bulb trim seal has metal retainer strip, recommended cutting tool is metal shears/tin snips.**
4. Clean lower surface of front roof (item #1) and rear roof (item #2) as required, then apply front/rear foam strips (item #8), front side foam strips (item #9), and rear side foam strips (item #14) as shown. Trim seals as required. (See illustrations 1-3, 1-4 and 1-5).

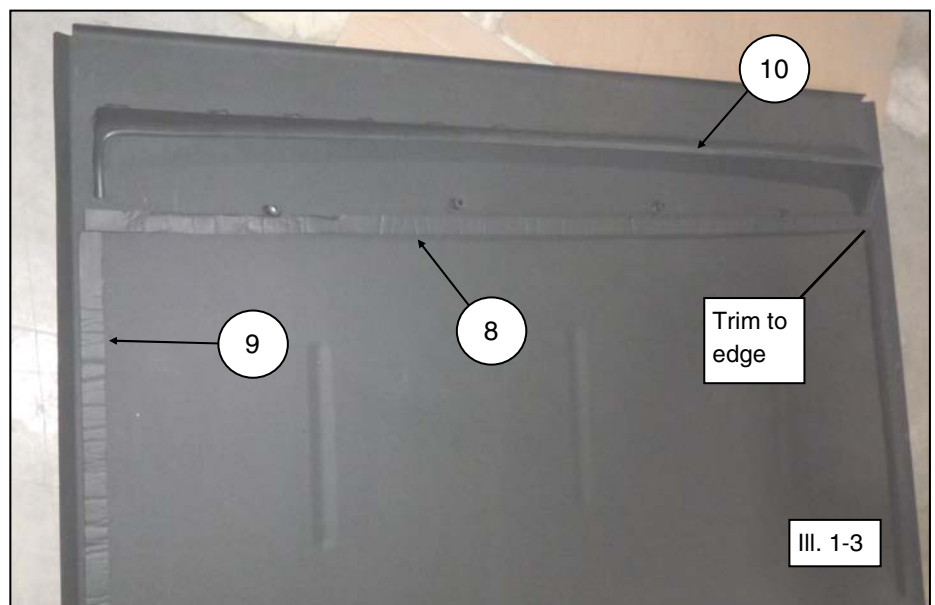
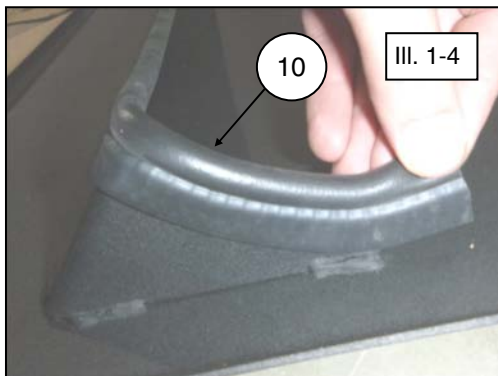
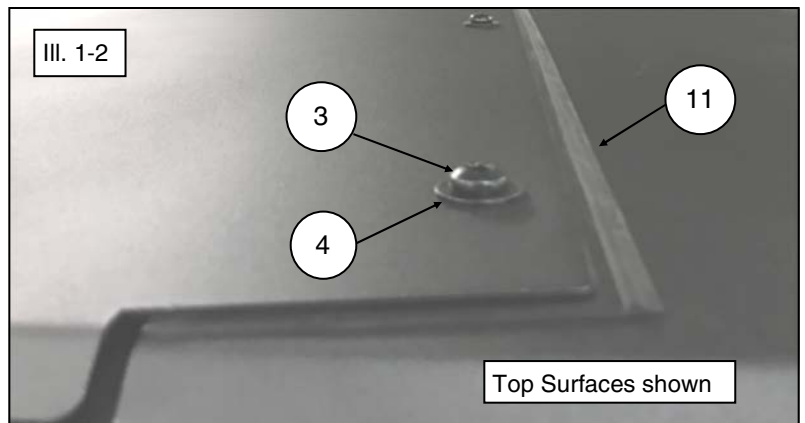
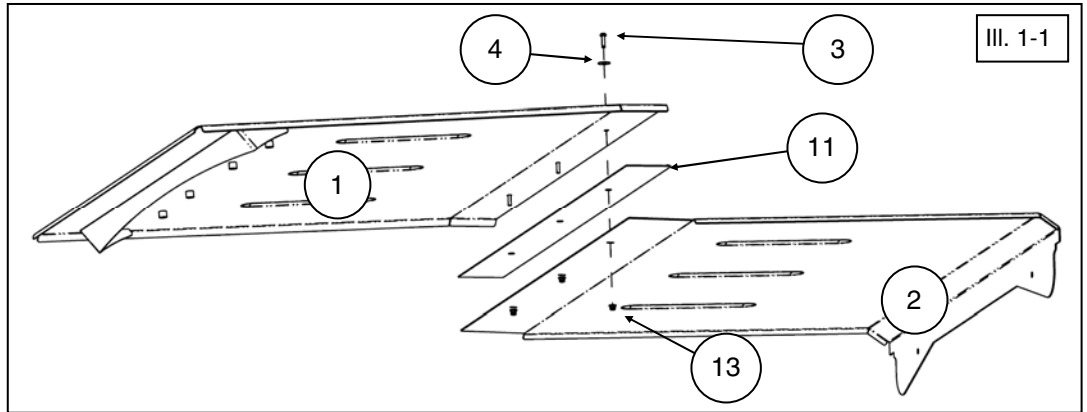

**Installation Instructions
(Continued):**

5. For the rear roof panel (item #2), apply rear foam strip (item #8) along rear edge as shown. Apply the rear side foams (item #14) along the side edges as shown. Then apply the cross-member foam strip (item #15) in the two locations shown. (See illustration 1-5).
6. For the middle holes of the roof overlapping seam, attach three clamps (item #12) to the assembly as shown. From the top surface, secure the middle clamps using M6 screws (item #3) and M6 washers (item #4). Fasten the clamps with M6 locknuts (item #13). (See illustration 1-6). **Note: Do not tighten hardware at this step since adjustments may be required later.**
7. Place roof assembly on the top of the vehicle cab frame. (See illustration 1-7).
8. Align the center clamps (item #12) onto the middle cab frame tube, so that these can be fit onto the tube. (See illustration 1-8).

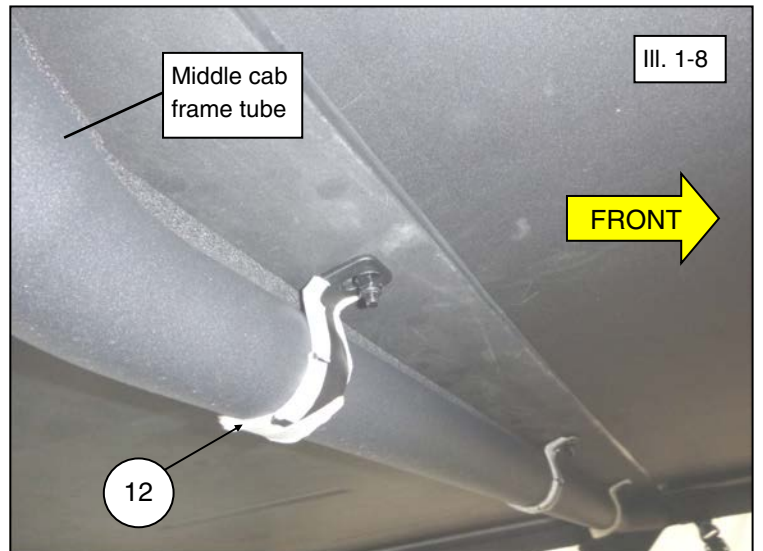
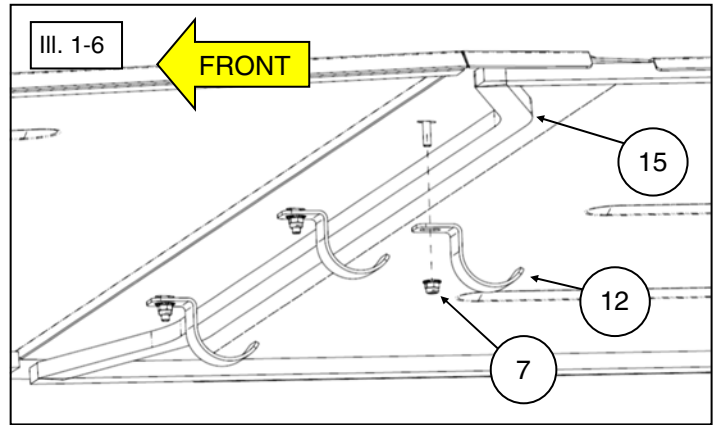
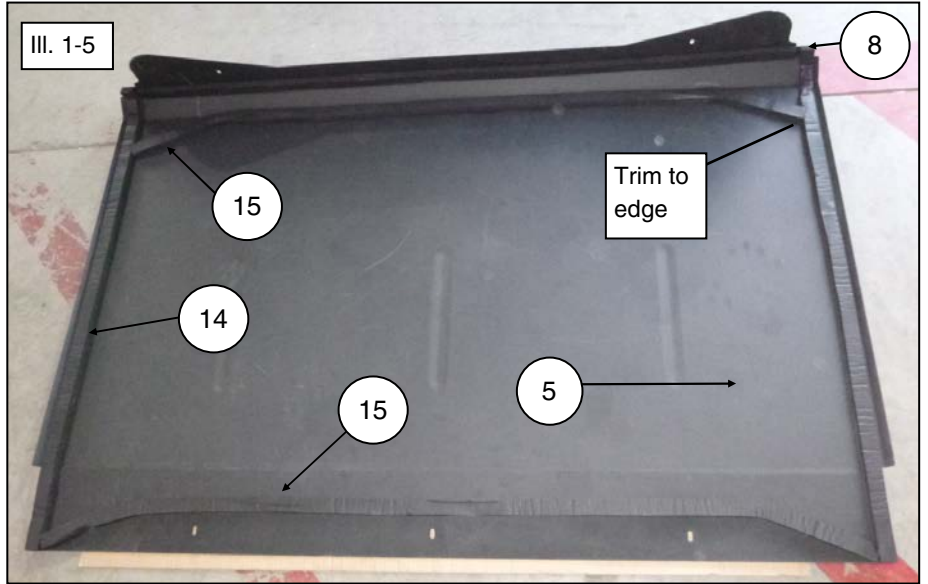

Installation Instructions (Continued):

- Secure the rear of the roof to the vehicle using the M6 screws (item #3) and flat washers (item #4) as shown. Fasten using the clamps (item #12) and M6 locknuts (item #13). (See illustrations 1-9 and 1-10). **Note: Do not tighten hardware at this step since adjustments may be required later.**

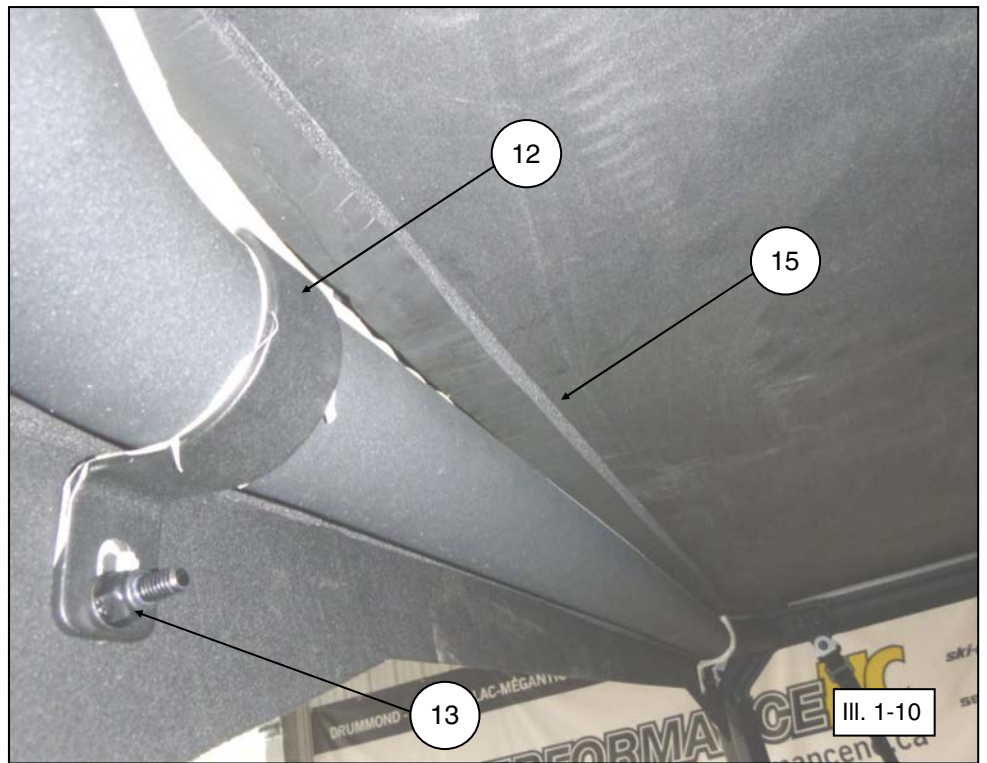
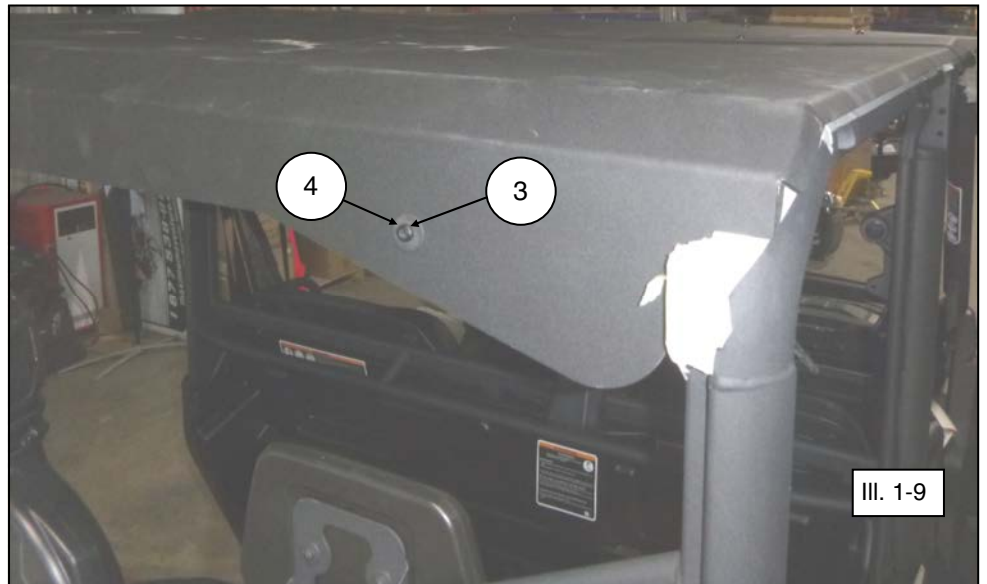

Installation Instructions (Continued):

10. From the top surface, secure front of roof using M8 screws (item #5) and flat washers (item #6) as shown. (See illustration 1-11).
11. From underneath roof, loosely fasten front screws with M8 locknuts (item #7) as shown. (See illustration 1-12).
12. Tighten all hardware to specifications: M6 Rear fastener spec. M8 Front fastener spec.

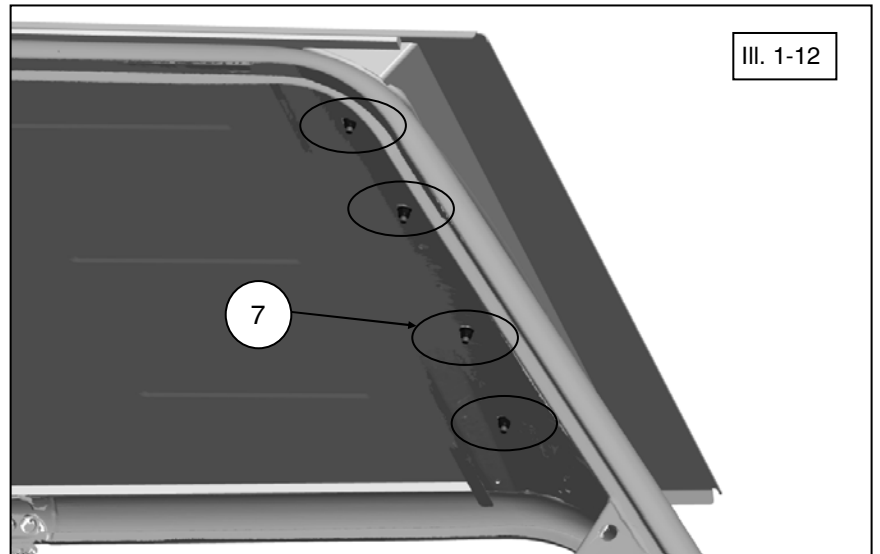
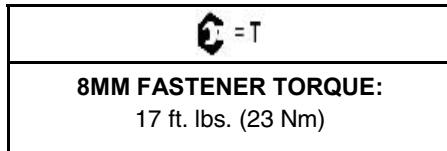
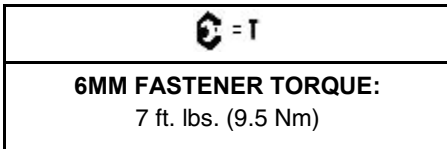
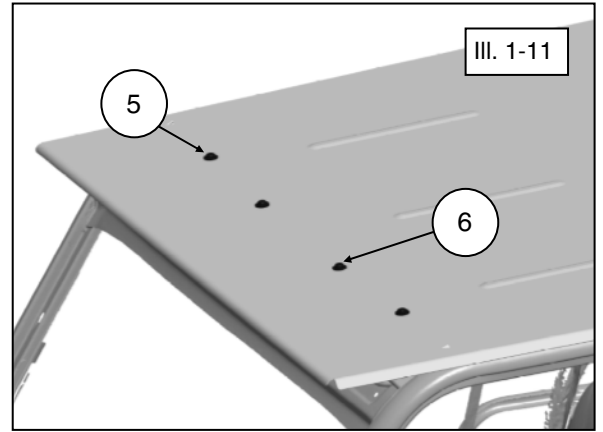

Use and Care Information:

- Check the accessory mounts frequently and retighten hardware if necessary.
- Replace this accessory with a new one if it is damaged.
- Never use petroleum solvents such as gasoline, thinner, benzene, acid or alkaline cleaners.

For additional assistance, please contact Kolpin customer service department at

One Year Limited Warranty

For the period of one (1) year from the purchase date, Kolpin will replace for the original purchaser, free of charge, any part or parts found upon examination by Kolpin to be defective in material, workmanship, or both.

All transportation costs incurred submitting product to Kolpin for warranty consideration must be borne by the purchaser. If Kolpin determines that the product must be returned to the factory for credit, please call 1-877-956-5746 for a Return Merchandise Authorization (RMA) number and shipping instructions.

This warranty does not apply to parts that have been damaged by accident, alteration, abuse, improper maintenance, normal wear, or other causes beyond the manufacturer's control. In order to protect you and your ATV, certain parts of the accessory system and/or hardware are designed to fail when the equipment is over-stressed. Parts that are lost due to loosening and improper maintenance are not covered under warranty. This warranty does not cover removal or reinstallation labor fees of the plow system and related components.

Peripheral products such as engines, electric motors, and actuators may carry an original manufacturer's warranty. Most hardware is general in nature and is easily obtained locally. Be sure to replace with minimum metric class 8.8 specification.