

# 2025-26 | KOLPIN OUTDOORS



PROTECTING YOUR ESSENTIAL GEAR SINCE 1943



**WE  
ARE** | **KOLPIN**  
**OUTDOORS**

**PROTECT THE GEAR YOU NEED. LIVE THE LIFE YOU LOVE.**

Whether your journey requires one horse or 400hp; from woodlands to farmland, from marsh to mountain, the need to protect your most important gear is always there.

That's where we come in: building the smartest and toughest protection solutions to keep your investments – and you for that matter – safe and sound no matter what nature dishes out. We are authentic outdoorsmen that created our first gun case over 80 years ago, and have been making it better ever since.

Our products are intuitively designed by engineers who live for the outdoors. Our products perform even in the most demanding environments. And we know that keeping you and your gear safe ultimately leads to what we all live for... better hunts, better rides, turning work into fun, stronger legacies and lasting traditions.

Thank you for choosing Kolpin and carrying on a time-tested lineage of passionate outdoorsmen who demand the best gear to help them live the life they love.

**6 NEW PRODUCTS**

**10 RHINO GRIPS**

**32 GUN BOOTS**

**46 GUN & GEAR TRANSPORT**

**56 STORAGE**

**70 DIRTWORKS**

**76 RECEIVER HITCH ACCESSORIES**

**84 MIRRORS**

**88 MISCELLANEOUS ACCESSORIES**

**96 PLOW SYSTEMS & ACCESSORIES**

**112 WINCHES & ACCESSORIES**

**124 UTV DOORS**

**130 UTV ROOFS**

**134 UTV WINDSHIELDS**

**138 FITMENT CHARTS**

♦ This product is designed to fit most vehicles, however Kolpin does not guarantee vehicle fitment for all vehicles. See kolpin.com for the latest vehicle fitment. Always refer to your vehicle's OEM operator manual to understand warnings and fitment, which takes precedence over Kolpin product instructions and fitment. Pictures are a representation of the product you will be getting but may vary due to product revisions.

# NEW

# PRODUCTS



UTV GLASS WINDSHIELD  
POLARIS RANGER 500

28135 - PG. 162



UTV GLASS WINDSHIELD  
CFMOTO® U10

28920 - PG. 154



UTV WINDSHIELD REAR PANEL  
POLARIS RANGER 570

2773 - PG. 162



RHINO GRIP  
FLEX 4.5

21572 (PAIR) - PG. 30



RHINO GRIP  
FLEX 6.0

21574 (PAIR) - PG. 30



STARTER PACK  
RHINO GRIP FLEX

21575 - PG. 31



UTV WINDSHIELD REAR PANEL  
POLARIS RANGER XP 900/1000

2634 - PG. 162



MID-SIZE/CROSSOVER UTV  
ALUMINUM BED BOX

53472 - PG. 59



UTV DIAMOND PLATE  
BEDSIDE SADDLE BOX

53475 - PG. 59



RHINO GRIP FLEX  
PRO PACK

21576 - PG. 31



RHINO GRIP XLr  
DOUBLE - CFMOTO®

21594 (PAIR) - PG. 21

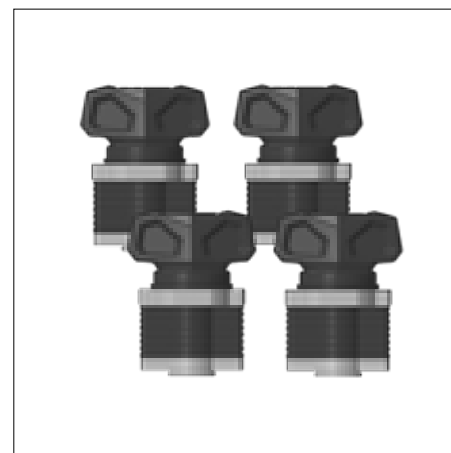

CFMOTO® QUICK-  
ATTACH PLUNGERS

98516 (1) / 53506 (4) - PG. 91



50Q COOLER  
ORANGE + GRAY

99051 - PG. 89



50Q COOLER  
ORANGE

99050 - PG. 89



POLARIS RANGER 570 FRONT  
STEEL HALF DOORS

32100 (PAIR) - PG. 128



**POLARIS RANGER 570 FRONT UPPER SOFT DOORS**

32600 (PAIR) - PG. 128



**POLARIS RANGER SP 570 REAR STEEL HALF DOORS**

32110 (PAIR) - PG. 129



**POLARIS RANGER SP 570 REAR UPPER SOFT DOORS**

32610 (PAIR) - PG. 129



**WINCH MOUNT KIT POLARIS RANGER XD 1500**

25-3450 - PG. 167



**SUN VISOR**

98700 - PG. 90



**UTV SIDE MIRRORS LANDSCAPE**

98325 - PG. 85



**KOLPIN ATV EXPEDITION PLOW IN A BOX**

10-0520 - PG. 107



**KOLPIN UTV EXPEDITION PLOW IN A BOX**

10-5520 - PG. 107

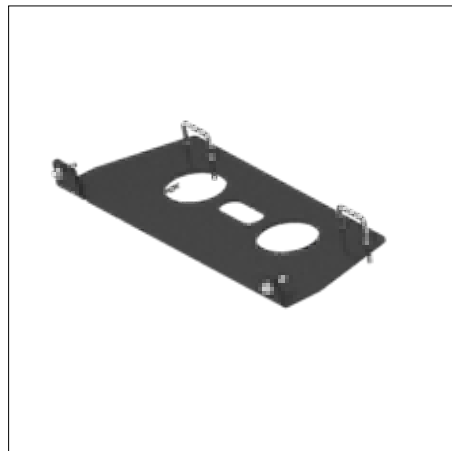

**ATV PLOW MOUNT CFORCE 800/1000 GEN 3**

15-9030 - PG. 143



**UTV SIDE MIRRORS PORTRAIT**

98320 - PG. 85



**UTV LANDSCAPE SIDES & REARVIEW MIRROR COMBO**

98327 - PG. 85



**UTV PORTRAIT SIDES & REARVIEW MIRROR COMBO**

98322 - PG. 85



**FRONT-CONNECT PLOW MOUNT CFMOTO® U10**

35-9030 - PG. 155



**FRONT-CONNECT PLOW MOUNT KAWASAKI® RIDGE**

35-2060 - PG. 161



**WINCH MOUNT KIT POLARIS RZR PRO XP**

25-3460 - PG. 171

**NOTES:**

Five horizontal lines for notes.

# RHINO GRIPS

ENGINEERED TO SAFELY AND SECURELY TRANSPORT YOUR GEAR

We've purpose-built the most versatile way to safely secure and transport your gear. Period.

Whatever your tool, firearm or implement, wherever you want to secure it, take it or mount it, we've got a solution for you.



RHINO GRIPS

SECURE YOUR GEAR AND GO











# CHOOSE YOUR GRIP

**DESIGNED WITH ONE PRINCIPLE IN MIND:  
SAFELY & SECURELY TRANSPORT YOUR GEAR.**

Each Rhino Grip model features durable, flexible rubber grips to hold your gear securely, along with a variety of mounting solutions so you can fully customize your gear transport experience.

All Rhino Grips are sold in pairs. All configurations include mounting hardware, except for the FLEX models.

RHINO GRIP	CAPACITY	CONSTRUCTION	ROTATION	ANGLE/TILT	GRIP STYLE	STYLES
<b>PRO</b>						
	50 LBS.	Rubber over-molded aluminum	360°	160°	Adjustable	Pro: 21560 Polaris L&R ATV: 21561 Polaris L&R UTV: 21562 Can-Am® LinQ®: 21563
<b>RATCHETING</b>						
	15 LBS.	Rubber over-molded heavy-duty nylon	360°	Fixed	Adjustable	Ratcheting: 21540 Polaris L&R ATV: 21541 Polaris L&R UTV: 21542 Can-Am® LinQ®: 21546
<b>XLR</b>						
	15 LBS.	Rubber over-molded heavy-duty nylon	360°	160°	Adjustable	XLR: 21550 Polaris L&R ATV: 21552 Polaris L&R UTV: 21554 XLR Handlebar: 21556 Can-Am® LinQ®: 21557
<b>XLR DOUBLE</b>						
	20 LBS.	Rubber over-molded heavy-duty nylon	360°	160°	Adjustable	XLR Double: 21551 Polaris L&R ATV: 21553 Polaris L&R UTV: 21555 Can-Am® LinQ®: 21558 CFMOTO®: 21594
<b>XL</b>						
	15 LBS.	Rubber over-molded heavy-duty nylon	360°	160°	Adjustable	XL: 21510 Handlebar Mount: 21530 UTV ROPS Mount: 21535
<b>XL DOUBLE</b>						
	20 LBS.	Rubber over-molded heavy-duty nylon	360°	160°	Adjustable	XL Double: 21515
<b>STANDARD</b>						
	10-15 LBS.	Rubber over-molded nylon	Fixed	Fixed	Fixed	Single: 21500 Double: 21505 Suction Cup: 21520
<b>FLEX</b>						
	15-20 LBS.	Rubber over-molded nylon	Fixed	Fixed	Fixed	1.5: 21570 3.0: 21571 4.5: 21572 6.0: 21574

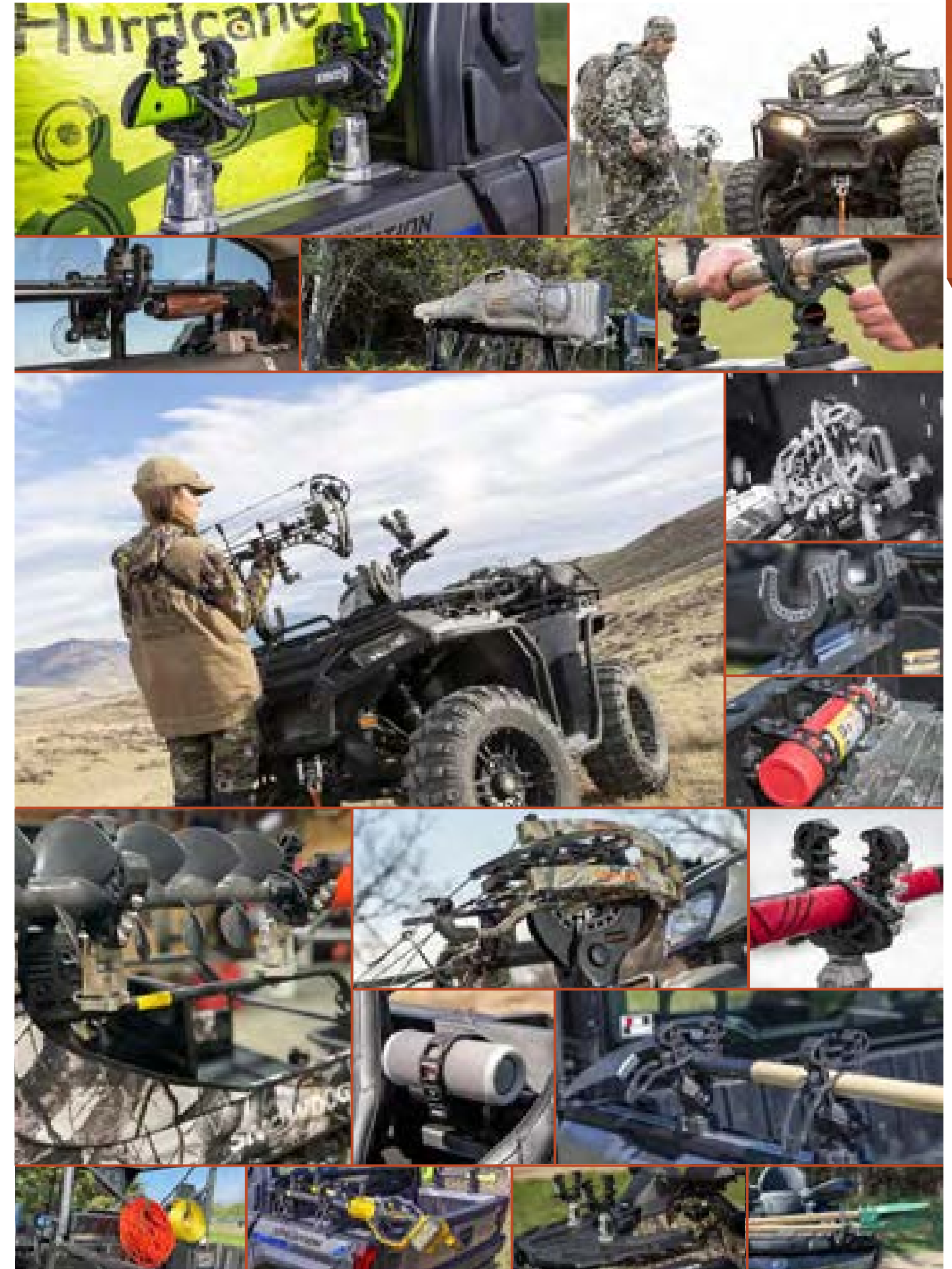



# RHINO GRIP PRO

## THE TOUGHEST RHINO GRIPS YET

We've driven trucks over these grips trying to break them. We failed — the Rhino Grip Pros did not.

Engineered to securely transport heavy-duty gear like scoped rifles, crossbows, ice augers, and more — across the toughest terrain and in the harshest temperatures.

### DURABLE GRIPS

Rubber over-molded cast-aluminum

### TILT DESIGN

Tilts 180° in 30° increments

### ROTATES 360°

Tool-free base rotation

### HEAVY-DUTY BASE

Mounts to:

- Tubular or square bars from 5/8" to 2" diameter
- Flat, drillable surfaces

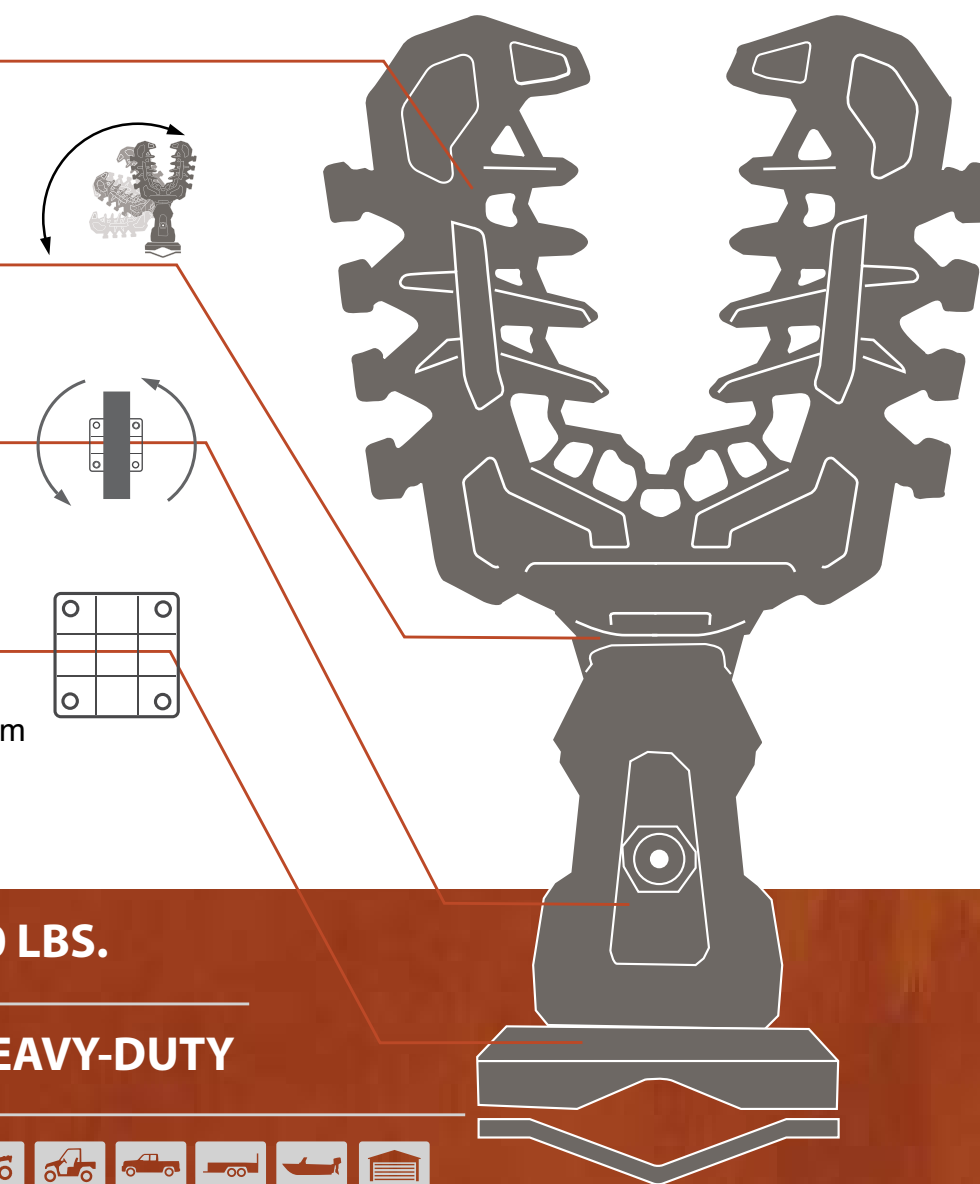

<b>CAPACITY</b>	<b>50 LBS.</b>
<b>BEST USED FOR</b>	<b>HEAVY-DUTY</b>
<b>WORKS BEST ON</b>	

### RHINO GRIP PRO

- Tool-free tilt angling with 6 positions and infinite rotation
- Standard version features a 4-corner bolting system
- Can-Am® LinQ® version includes appropriate anchors
- Polaris UTV version includes both Lock & Ride® and Lock & Ride® Max anchors
- Includes (2) heavy-duty rubber straps, hardware, and mounting plates



**STANDARD (PAIR) - 21560**

**POLARIS SPORTSMAN/RZR (PAIR) - 21561**

**POLARIS RANGER/GENERAL/XPEDITION\* (PAIR) - 21562**

**CAN-AM® LINQ® SYSTEM (PAIR) - 21563**

**HEAVY-DUTY REPLACEMENT STRAPS (PAIR) - 21590**





# RHINO GRIP RATCHETING

## ONE-HANDED CLOSURE OR RELEASE

If you like the idea of one-handed, quick-release button access to your gear and no tie-down straps, this is your solution.

The ability to adjust the 2 grips to different widths to accommodate odd shapes makes these extra-versatile.

### RATCHETING DESIGN

Allows securing items from 1" to 4"

### GRIP TEXTURE

Compressible rubber

### PUSH ARM TO RATCHET CLOSED; QUICK-RELEASE BUTTON

One-handed easy access to gear

### KWIK-CLIP DESIGN

Provides on/off and rotational adjustment in field

### HEAVY-DUTY BASE SYSTEM

Mounts to:

- Tubular or square bars from 5/8" to 2" diameter
- Flat, drillable surfaces

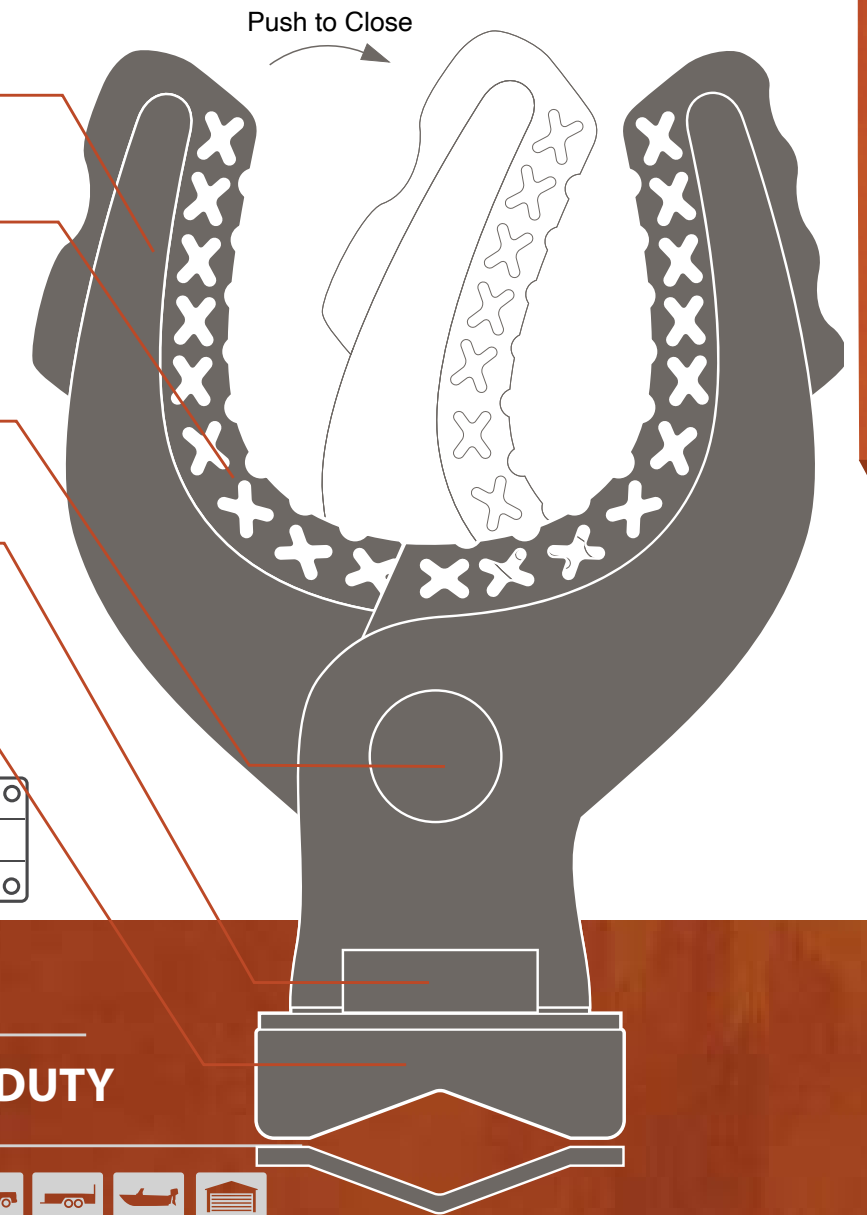
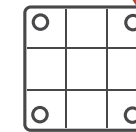

**CAPACITY** 15 LBS.

**BEST USED FOR** MEDIUM-DUTY

**WORKS BEST ON**

### RATCHETING RHINO GRIP

- Heavy-duty reinforced grip arms with protective internal rubber over-molding
- Indexed ratcheting grip arm secures items from 1" to 4" in diameter
- Kwik-Clip design allows base rotation and easy removal of grips from base if needed
- Standard version has 4-corner bolting system
- Can-Am® LinQ® version includes appropriate anchors
- Polaris UTV version includes both Lock & Ride and Lock & Ride Max anchors
- Includes hardware and mounting plates



STANDARD (PAIR) - 21540

POLARIS SPORTSMAN/RZR (PAIR) - 21541

POLARIS RANGER/GENERAL/XPEDITION\* (PAIR) - 21542

CAN-AM® LINQ® SYSTEM (PAIR) - 21546





# RHINO GRIP XL<sub>R</sub>

## THE MOST POPULAR RHINO GRIP... REDESIGNED

Kolpin's newest addition to the Rhino Grip family is a re-imagined version of our best-selling Rhino Grip XL.

We've enhanced it with increased clamping functionality, stronger grip arms, reinforced straps, and independently adjustable arms — allowing you to secure gear of varying shapes and sizes with ease.

### DURABLE FLEXIBLE GRIPS

Over-molded heavy-duty nylon cushions and protects while providing custom fit

### STRENGTH & ADJUSTABILITY

Independent Grip-Arm adjustment for securing both large & small items

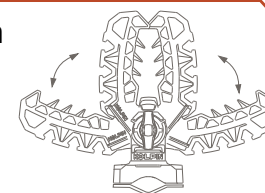

### ROTATES 360°

Thumb-screw-actuated grip stabilizer allows 360° rotation

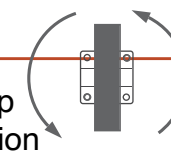

### HEAVY-DUTY BASE SYSTEM

Mounts to flat surfaces or 3/4" to 2" round tubing

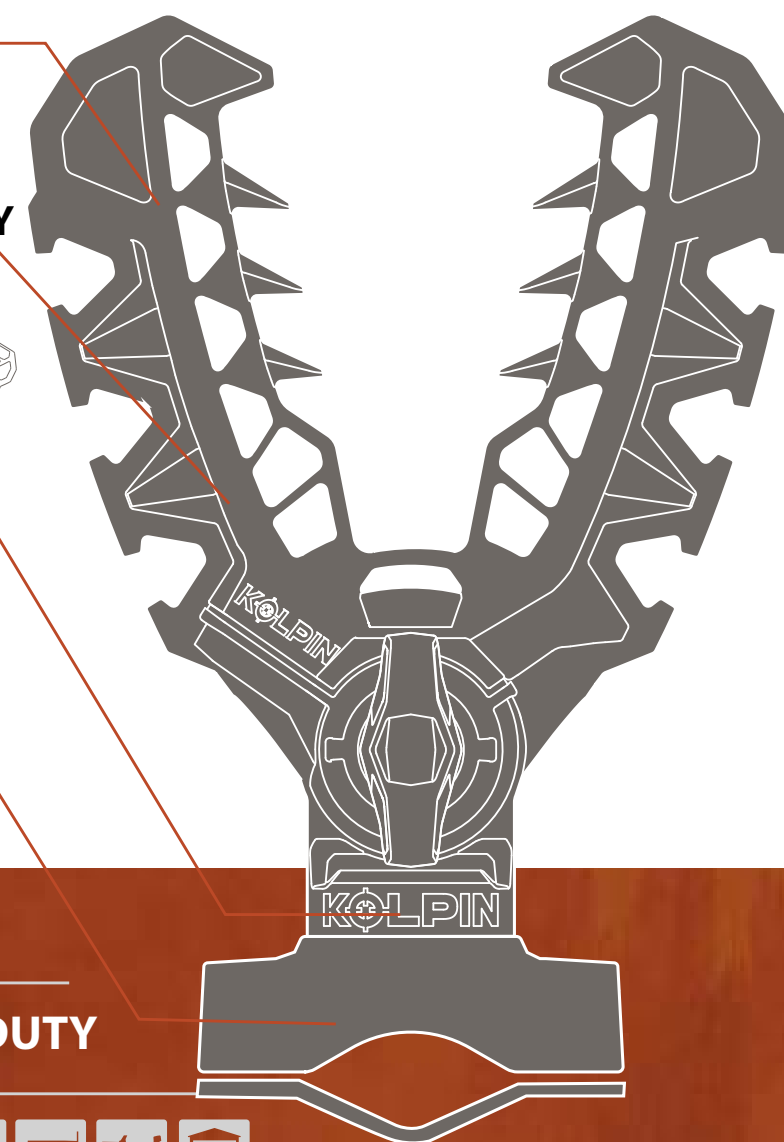
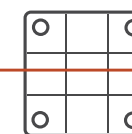

<b>CAPACITY</b>	<b>15 LBS.</b>
<b>BEST USED FOR</b>	<b>MEDIUM-DUTY</b>
<b>WORKS BEST ON</b>	

### RHINO GRIP XL<sub>R</sub>

- Independent, tool-free grip arm adjustment for securing both large and small items, such as:
  - Rifles / Shotguns / ARs / Soft Gun Cases / Bows
  - Garden & Farm Tools / Fishing Rods / Ice Augers
  - Hub Blinds / Shelters
- Includes (2) heavy-duty straps and mounting hardware
- Dual-loop straps secure large and small items with different grip arm positions
- Can-Am® LinQ® version includes appropriate anchors
- Polaris UTV version includes both Lock & Ride® and Lock & Ride® Max anchors



- STANDARD (PAIR) - 21550
- BAR MOUNT (PAIR) - 21556
- POLARIS SPORTSMAN/RZR (PAIR) - 21552
- POLARIS RANGER/GENERAL/XPEDITION\* (PAIR) - 21554
- CAN-AM® LINQ® SYSTEM (PAIR) - 21557
- HEAVY-DUTY REPLACEMENT STRAPS (PAIR) - 21591

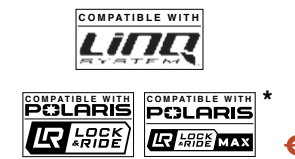



# RHINO GRIP XLr DOUBLES

## OUR MOST POPULAR GRIPS... REDESIGNED TIMES TWO

2 independent grips that can be set at different widths and carry twice the gear. The time-tested strength of these grips and straps have been enhanced and redesigned to be the most versatile Rhino Grip Doubles we've ever built.

### STRENGTH & ADJUSTABILITY

Independent Grip-Arm adjustment for securing both large & small items

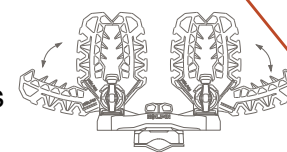

### DURABLE FLEXIBLE GRIPS

Over-molded heavy-duty nylon cushions and protects while providing custom fit

### ROTATES 360°

Thumb-screw-actuated grip stabilizer allows base to rotate 360°

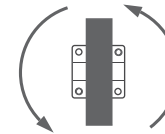

### HEAVY-DUTY BASE SYSTEM

Mounts to flat surfaces or 3/4" to 2" round tubing

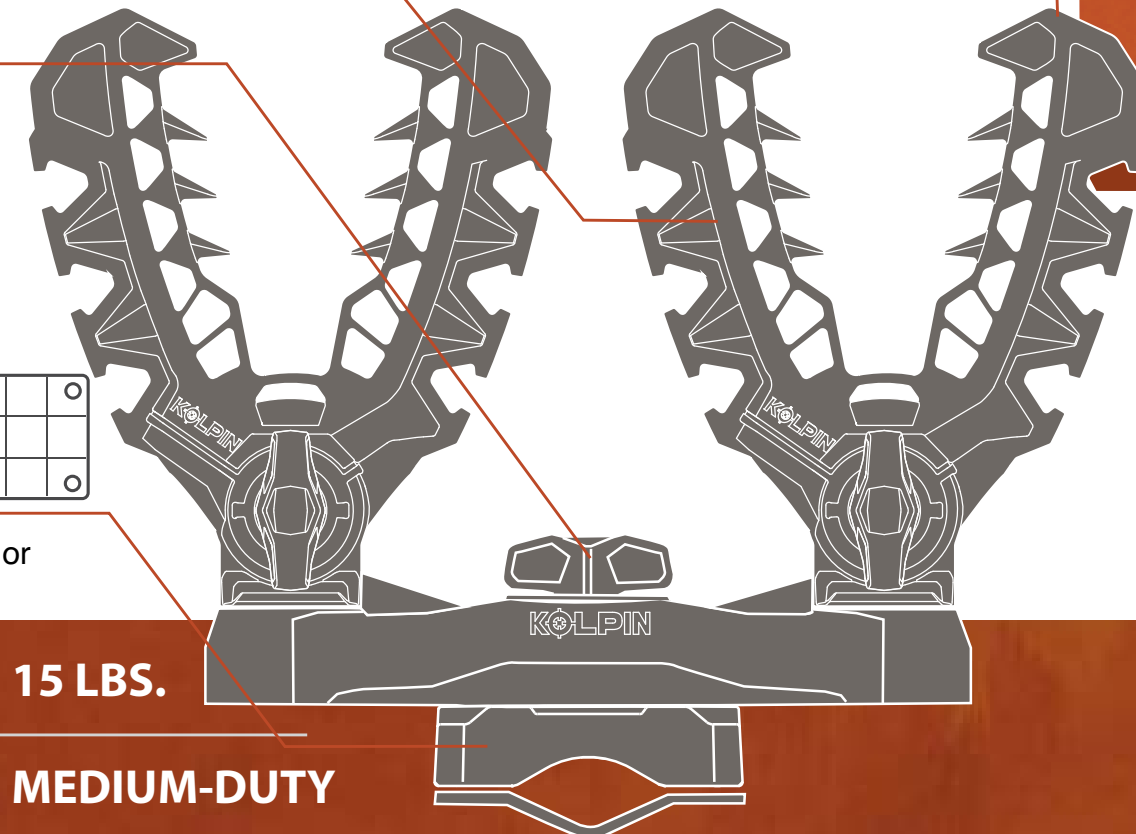
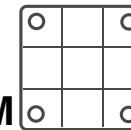

**CAPACITY** 15 LBS.

**BEST USED FOR** MEDIUM-DUTY

**WORKS BEST ON**



### RHINO GRIP XLr DOUBLES

- Independent tool-free grip-arm adjustment for securing both large and small items such as:
  - Rifles / Shotguns / ARs / Soft Gun Cases / Bows
  - Garden & Farm Tools / Fishing Rods / Ice Augers
  - Hub Blinds / Shelters
- (4) Heavy-Duty retaining straps, hardware & mounting plates included
- Dual-loop straps for securing large and small items with different grip arm positions
- Can-Am® LinQ®, CFMoto® and Polaris UTV versions include appropriate anchors



**STANDARD (PAIR) - 21551**

**POLARIS SPORTSMAN/RZR (PAIR) - 21553**

**POLARIS RANGER/GENERAL/XPEDITION\* (PAIR) - 21555**

**CAN-AM® LINQ® SYSTEM (PAIR) - 21558**

**CFMOTO® (PAIR) - 21594**

**HEAVY-DUTY REPLACEMENT STRAPS (PAIR) - 21591**





**FLEXIBLE GRIPS**

Rubber over-molded heavy-duty nylon

**TILTING DESIGN**

Tilts 160° in 40° increments

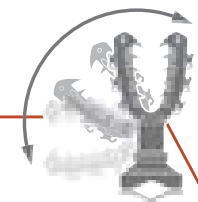

**ROTATES**

Base rotates 360°

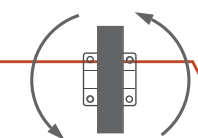

**HEAVY-DUTY BASE SYSTEM**

Mounts to tubular or square bars from 5/8" to 1 3/4" in diameter or to flat, drillable surfaces

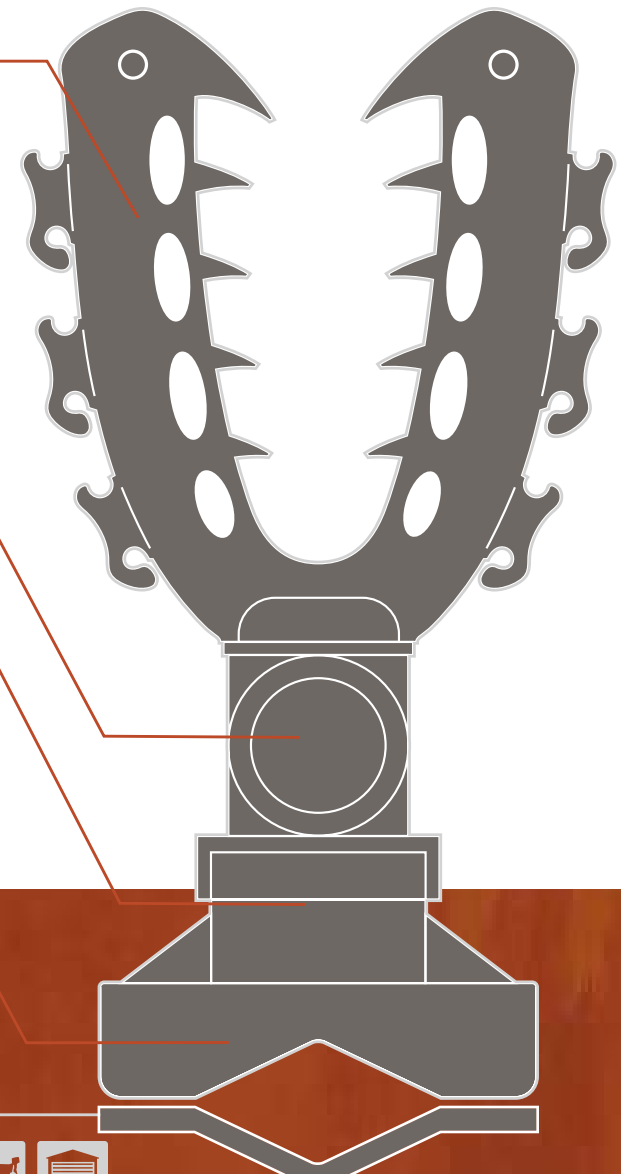
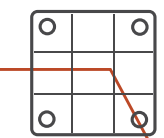

<b>CAPACITY</b>	<b>15 LBS.</b>
<b>BEST USED FOR</b>	<b>MEDIUM-DUTY</b>
<b>WORKS BEST ON</b>	

**RHINO GRIP XL**

- Tool-free Kwik-clip design allows 360° rotation & easy removal of grips from base if needed
- Standard version has 4-corner bolting system
- (2) rubber straps, hardware and mounting plates included



- STANDARD (PAIR) - 21510
- HANDLEBAR MOUNT (PAIR) - 21530
- UTV ROLL BAR MOUNT (PAIR) - 21535
- REPLACEMENT STRAPS (PAIR) - 87010

**RHINO GRIP XL**

**THE MOST POPULAR GRIP WE'VE EVER PURPOSE-BUILT**

XL Grips have been everywhere.

They've carried medium-weight tools, guns, bows, shovels, rods, axes and countless other items to every corner of land and sea.

Where will they securely transport your gear?



# RHINO GRIP XL DOUBLES

## OUR MOST POPULAR GRIPS TIMES TWO

XL Doubles give you the time-tested strength of our most popular XL grips, with twice the gear capacity. 20 lbs. of combined gear weight can be spread out, while only using 1 mounting plate.

The possibilities of medium-weight gear transport combinations are endless.

### FLEXIBLE GRIPS

Rubber over-molded heavy-duty nylon

### TILTING DESIGN

Tilts 160° in 40° increments

### ROTATES

Base rotates 360°

### HEAVY-DUTY BASE SYSTEM

Mounts to tubular or square bars from 5/8" to 2" in diameter or to flat, drillable surfaces

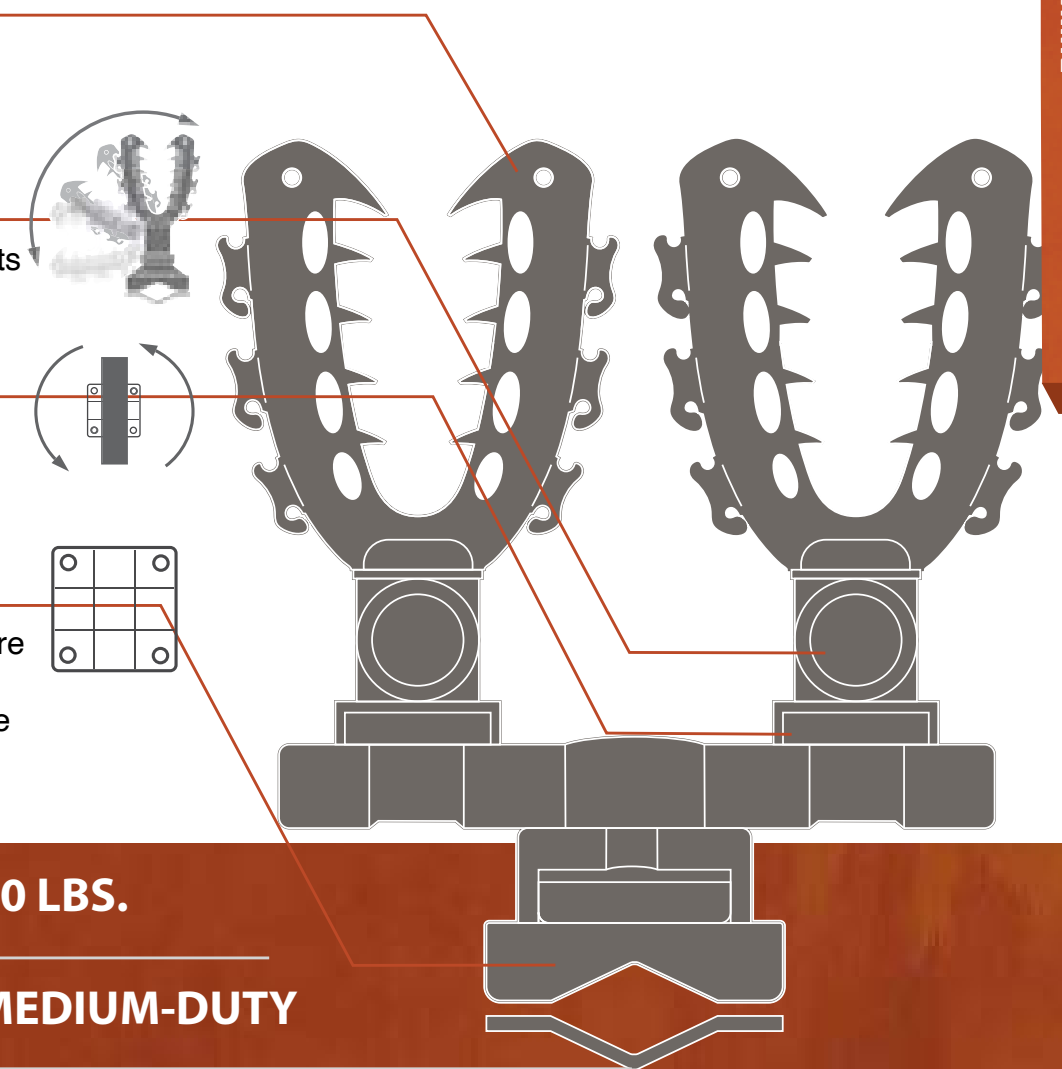

**CAPACITY** 20 LBS.

**BEST USED FOR** MEDIUM-DUTY

**WORKS BEST ON** 

### RHINO GRIP XL DOUBLES

- Allows for secure transport of 2 items
- Tool-free Kwik-clip design allows 360° rotation & easy removal of grips from base if needed
- Standard version has 4-corner bolting system
- (4) rubber straps included
- Standard includes hardware and mounting plates



**STANDARD (PAIR) - 21515**  
**REPLACEMENT STRAPS (PAIR) - 87010**



### RHINO GRIP STANDARD

- Rubber over-molded flexible nylon construction
- Offset configuration to maximize rack space
- Mounts to tubular or square bars from 5/8" to 1 1/4" in diameter or to flat, drillable surfaces
- Single and Double versions have 4-corner bolting system
- Single version has 10 lbs. weight capacity and includes 2 rubber straps
- Double version has 15 lbs. weight capacity and includes 4 rubber straps
- Window Suction cup version has 5-10 lbs. weight capacity and includes 2 rubber straps
- All Rhino Grip are sold in pairs



21500

- SINGLE (PAIR) - 21500
- DOUBLE (PAIR) - 21505
- WINDOW SUCTION CUP (PAIR) - 21520
- REPLACEMENT STRAPS (PAIR) - 87010
- REPLACEMENT SUCTION CUPS - 71506



21505



21520

# RHINO GRIP STANDARD

**STRAP DOWN AND SECURE YOUR LIGHT-WEIGHT GEAR**

Easily secure your light-weight gear to any vehicle, wall or flat surface.



# RHINO GRIP FLEX

## HOLD JUST ABOUT ANYTHING... ANYWHERE

Our smallest member of the Rhino Grip family. These Flex Grips will hold an assortment of items of all different sizes on your ATV, UTV, Trailer, on the Shop or Garage wall, etc.

Use your own selected hardware to mount these wherever you need, in the way that you want.

### RHINO GRIP FLEX 1.5

- NEW and IMPROVED durability and stretch
- Adjustable rubber strap fits items up to 1 1/2" in diameter
- Protective non-slip over-molded rubber grip
- Built to carry gear such as: Garden Tools, Axes, Sledgehammers, Rifles/Shotguns, Cords/Hoses, Fishing Poles
- Durable, reinforced mounting base
- Mounts to flat surfaces or round tubes using bolts or hose clamps
- Compatible with 1/4" or 6mm diameter hardware or 1/2" hose clamps (not included)
- 15 lbs. weight capacity
- All Rhino Grip Flex are sold in pairs



21570 (PAIR)

#### BUILT TO CARRY GEAR SUCH AS :



### RHINO GRIP FLEX 3.0

- NEW and IMPROVED durability and stretch
- Adjustable rubber strap fits items up to 3 1/4" in diameter
- Protective non-slip over-molded rubber grip
- Built to carry gear such as: Fire Extinguishers (up to 3 1/4" Diameter), Bluetooth® Speakers, Water Jugs, Rifles/Shotguns, Garden Tools, Cords/Hoses
- Durable, reinforced mounting base
- Mounts to flat surfaces or round tubes using bolts or hose clamps
- Compatible with 1/4" or 6mm diameter hardware or 1/2" hose clamps (not included)
- 15 lbs. weight capacity
- All Rhino Grip Flex are sold in pairs



21571 (PAIR)

#### BUILT TO CARRY GEAR SUCH AS :



## RHINO GRIP FLEX 4.5

- Adjustable rubber strap fits items up to 4 1/2" in diameter
- Protective non-slip over-molded rubber grip
- Built to carry gear such as: Tow Strap/ Recovery Rope, Camping Chairs, Skis, Garden Tools, Cords/Hoses, Fence Posts, Fire Extinguishers (up to 4" Diameter), Bluetooth® Speakers
- Durable, reinforced mounting base
- Mounts to flat surfaces or round tubes using bolts or hose clamps
- Compatible with 1/4" or 6mm diameter hardware or 1/2" hose clamps (not included)
- 20 lbs. weight capacity
- All Rhino Grip Flex are sold in pairs

21572 (PAIR)

BUILT TO CARRY GEAR SUCH AS :



## RHINO GRIP FLEX 6.0

- Adjustable rubber strap fits items up to 6" in diameter
- Protective non-slip over-molded rubber grip
- Built to carry gear such as: Gun Boot, Hunting Blind, Wire Fence, Cords/Hoses, Tent, Fire Extinguishers (up to 6" Diameter), Recovery Kit
- Durable, reinforced mounting base
- Mounts to flat surfaces or round tubes using bolts or hose clamps
- Compatible with 1/4" or 6mm diameter hardware or 1/2" hose clamps (not included)
- 20 lbs. weight capacity
- All Rhino Grip Flex are sold in pairs

21574 (PAIR)

BUILT TO CARRY GEAR SUCH AS :



NEW

## RHINO GRIP FLEX STARTER PACK

- Set Includes 1 Pair of Rhino Grip Flex 1.5" and 1 Pair of Rhino Grip Flex 3.0
- Adjustable rubber strap fits items up to 1.5" and 3" in diameter
- Protective non-slip over-molded rubber grip
- Built to carry gear such as: Garden Tools, Axes, Sledgehammers, Rifles/Shotguns, Cords/Hoses, Fishing Poles
- Mounts to your ATV, UTV, SxS, Trailer, on the Shop or Garage wall, etc.
- Durable, reinforced mounting base.
- Mounts to flat surfaces or round tubes using bolts or hose clamps. Compatible with 1/4" or 6mm diameter hardware or 1/2" hose clamps (hardware not included)
- 15 lbs. weight capacity

21575

## RHINO GRIP FLEX PRO PACK

- Set Includes 2 Pairs of Rhino Grip Flex 1.5" and 2 Pairs of Rhino Grip Flex 3.0
- Adjustable rubber strap fits items up to 1.5" and 3" in diameter
- Protective non-slip over-molded rubber grip
- Built to carry gear such as: Garden Tools, Axes, Sledgehammers, Rifles/Shotguns, Cords/Hoses, Fishing Poles
- Mounts to your ATV, UTV, SxS, Trailer, on the Shop or Garage wall, etc.
- Durable, reinforced mounting base.
- Mounts to flat surfaces or round tubes using bolts or hose clamps. Compatible with 1/4" or 6mm diameter hardware or 1/2" hose clamps (hardware not included)
- 15 lbs. weight capacity

21576



NEW



NEW

# GUN BOOTS

KOLPIN STRONGHOLD  
CLASSICS, BRACKETS

Firearms transport for the new generation of adventurers.

Kolpin Stronghold Gun Boots = Quick, easy and secure attachment of your firearm to your vehicle. Select your mount, select your Boot, Slide and Click the Boot into the Auto-Latch mount. Adventure Confidently.













FIREARM  
TRANSPORT  
SYSTEM



# MOUNT YOUR FIREARM AND GO

The KOLPIN STRONGHOLD system is the result of an evolution over our 80-year history. The leather gun scabbard of the 1940s evolved into our famous hard-sided Gun Boot in the 1970s, and now has evolved into our KOLPIN STRONGHOLD system.

The newest and most versatile way to securely transport your rifles and shotguns.

MOUNT	WORKS BEST ON	AUTO-LATCH MOUNT	STEEL BRACKET	FITMENT	POLARIS FITMENT
<b>AUTO-LATCH MOUNT</b>					
 30816		✓		<ul style="list-style-type: none"> <li>53450 UTV Overbed Storage Rack</li> <li>53460 Hitch Cargo Carrier</li> <li>Flat Surfaces</li> <li>DIY Brackets</li> </ul>	
<b>BRACKET &amp; AUTO-LATCH MOUNT</b>					
 20710		✓	✓	<ul style="list-style-type: none"> <li>ATV Tube Racks</li> <li>UTV Bed-Rails</li> <li>Flat Drillable Surfaces</li> </ul>	Lock & Ride compatible with either (2) ATV 98500 anchors or (2) UTV 98510 anchors (sold separately)
<b>UTV BRACKET &amp; AUTO-LATCH MOUNT</b>					
 30810		✓	✓	<ul style="list-style-type: none"> <li>Most UTV Bed-Rails</li> <li>Roll Cages</li> <li>Flat Drillable Surfaces</li> </ul>	UTV Lock & Ride version available (30815)
<b>POLARIS RANGER/GENERAL BRACKET &amp; AUTO-LATCH MOUNT</b>					
 30815		✓	✓	<ul style="list-style-type: none"> <li>Polaris Ranger &amp; General Lock &amp; Ride Bed-Rails with (2) included anchors</li> </ul>	Polaris Ranger & General Lock & Ride Bed-Rails with (2) included anchors 
<b>DOUBLE UTV BED RAIL BRACKET &amp; (2) AUTO-LATCH MOUNTS</b>					
 20000		✓ (2)	✓ (2)	<ul style="list-style-type: none"> <li>UTV Bed-Rails from 41" to 55.5" wide</li> </ul>	Ranger, General & XPEDITION Lock & Ride compatible; See pg 41 for fitment

## GUN BOOTS

### KOLPIN STRONGHOLD GUN BOOT XL

- Includes zippered, padded protected liner
- Zippered/Magnetic Closure
- Largest and most protective padded interior
- Lockable

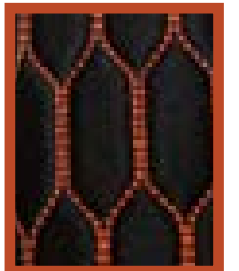

Inside Protective Padded Liner Stitching

### KOLPIN STRONGHOLD GUN BOOT L

- Compact lower profile case
- Padded interior liner





# GUN BOOT XL

## KOLPIN STRONGHOLD GUN BOOT XL

- Our largest and most protective interior of all Kolpin Gun Boot cases
- Includes zippered, padded protected liner
- Zippered/Magnetic Closure
- Lockable

20705

KOLPIN STRONGHOLD GUN BOOTS

### ENTRY

- Single-handed attached lid opening for quick access
- Integrated Rubber Closure Strap

### LOCKABLE

- To Kolpin Stronghold Auto-Latch mounts
- Lockable access door
- TSA Approved case

### MOUNTS

Compatible with Kolpin Stronghold Auto-Latch mounts

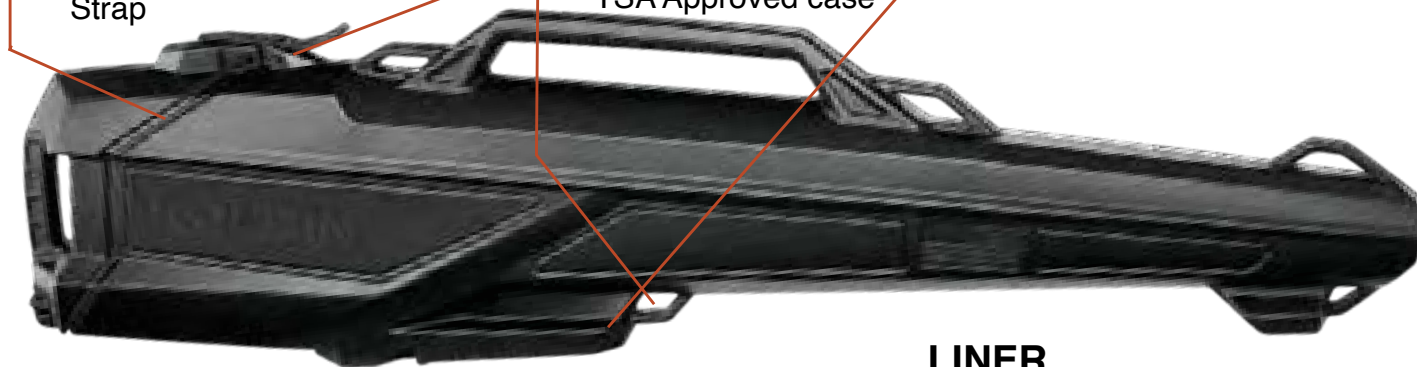

### LINER

- Premium zippered protective liner



Inside Protective Padded Liner Stitching

**CAPACITY** 52" L x 3 3/4" W x 10 1/2" H

**BEST USED FOR** SCOPED RIFLES & SHOTGUNS

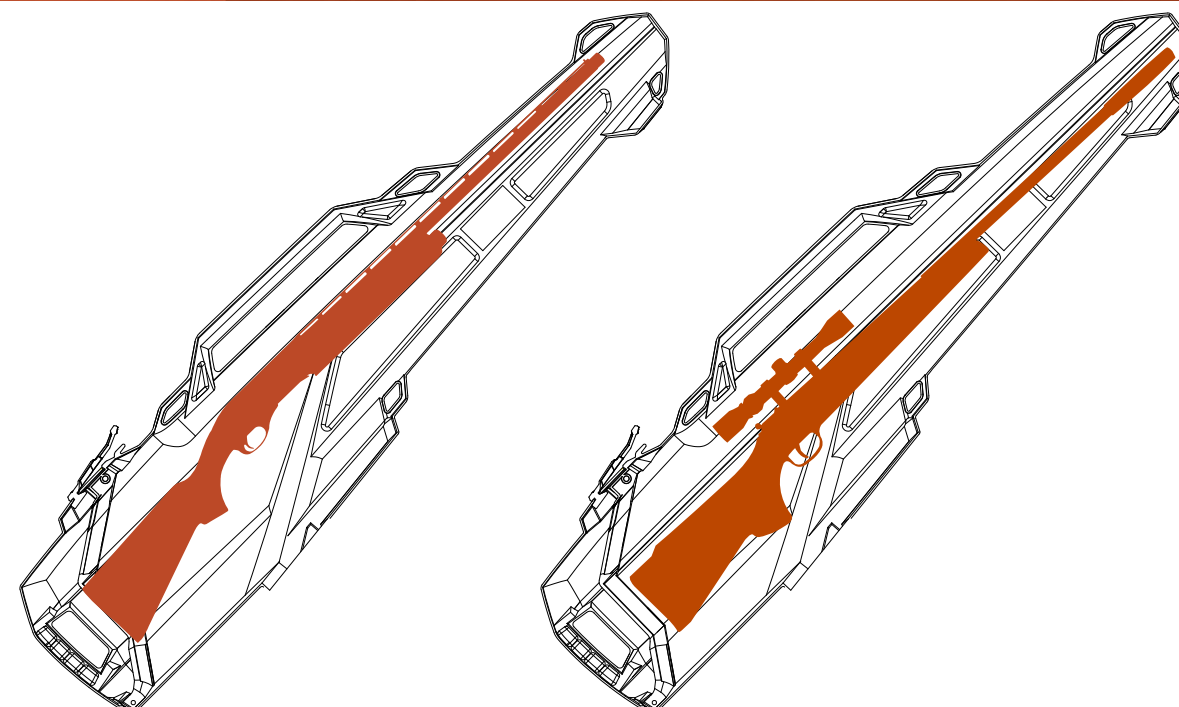
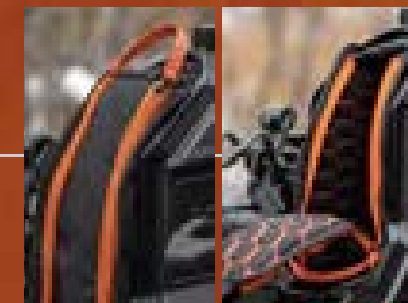



# GUN BOOT

L

## KOLPIN STRONGHOLD GUN BOOT L

- Compact, low profile case design
- Includes padded protective foam liner
- Secure rifles and shotguns up to 52" in length
- Single-handed entry utilizing attached lid & integrated rubber closure strap
- Also compatible with Boottector & Loop Brackets (see pg. 44)

**GUN BOOT L - 20740**

**GUN BOOT L & MOUNT COMBO - 20743**

- Includes mount 20710

### ENTRY

- Single-handed attached lid opening for quick access
- Integrated Rubber Closure Strap

### ERGONOMIC

- Integrated carrying handle
- Integrated feet Strap

### MOUNTS

- Compatible with Kolpin Stronghold Auto-Latch mounts
- Compatible with Boottector & Loop Brackets

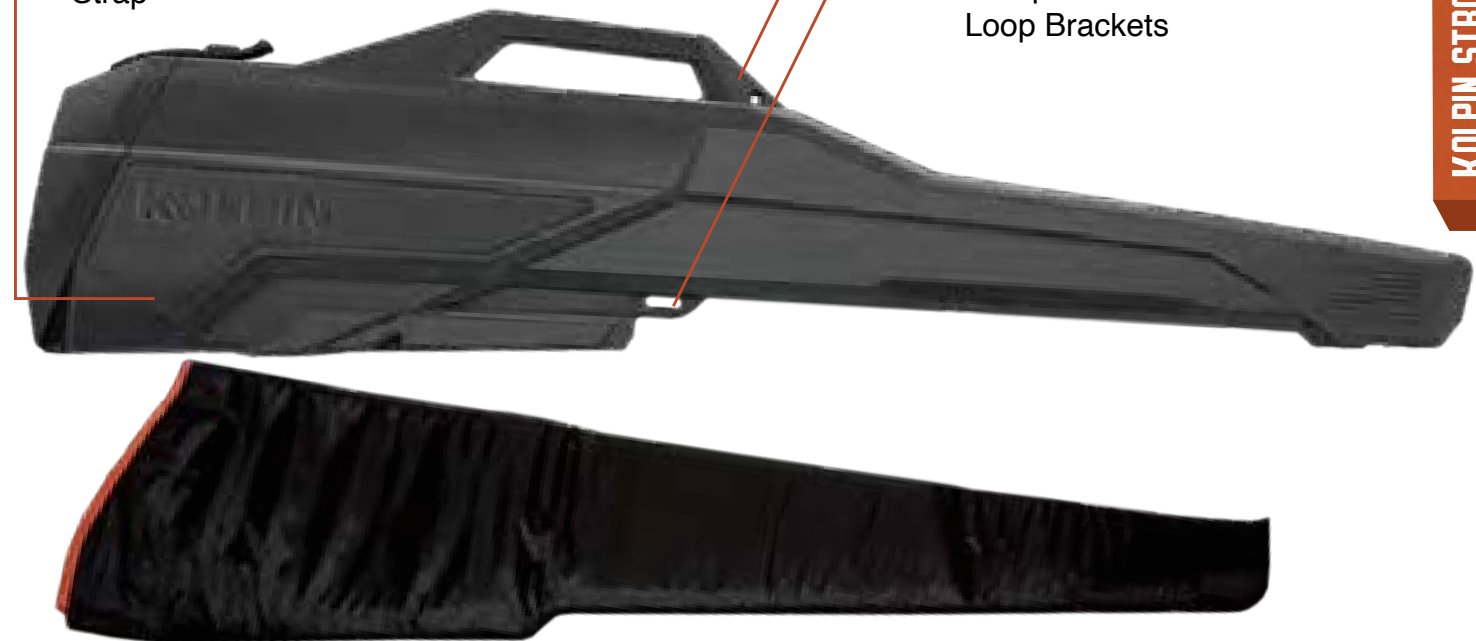

**CAPACITY** 52" L x 4 3/4" W x 9 1/4" H

**BEST USED FOR** SCOPED RIFLES & SHOTGUNS

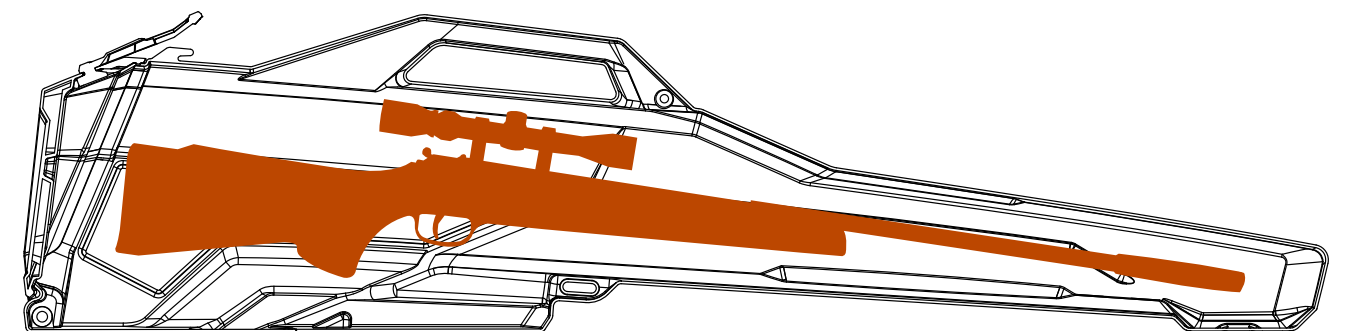
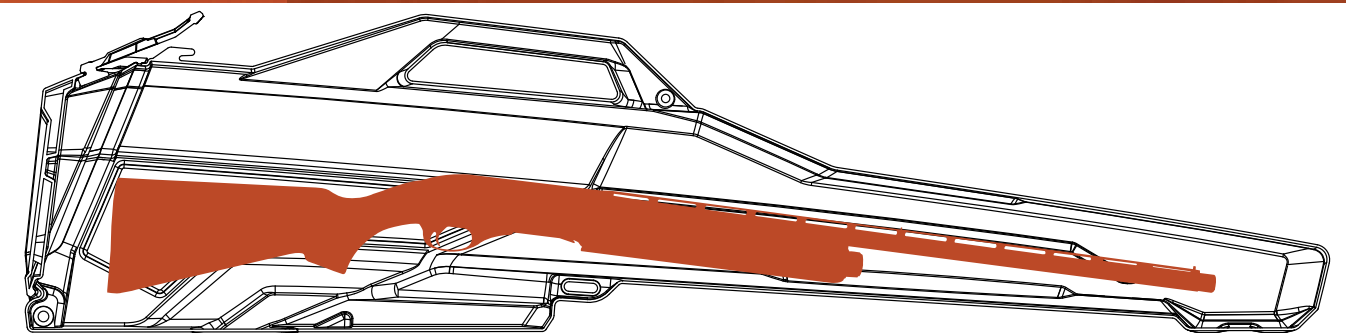
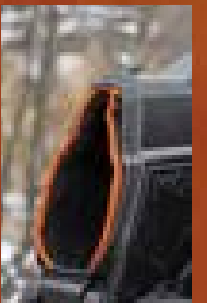

## KOLPIN STRONGHOLD UTV BRACKET & AUTO-LATCH MOUNT

- Auto-latching design provides quick secure attachment for all Kolpin Stronghold products to your UTV
- Engineered steel bracket for precision angling & attachment to vehicles
- Compatible with Polaris UTV Bed-Rails with (2) Polaris Lock & Ride compatible anchors (98510) sold separately



STANDARD - 30810  
RANGER/GENERAL - 30815



## KOLPIN STRONGHOLD BRACKET & AUTO-LATCH MOUNT

- Auto-latching design provides quick secure attachment for all Kolpin Stronghold products
- Engineered steel bracket for precision angling and attachment to vehicles
- Spring loaded latch with stainless steel spring
- Durable glass-reinforced nylon auto-latch construction
- Fits most ATV tubular racks and UTV beds or to any flat surface
- Includes u-bolts and mounting hardware. Included Mounting Hardware: (8) Nylon Lock Nuts, M6-1.0, (8) Flat Washer, M6, (4) U-Bolt, M6-1.0 x 25mm ID x 45mm, (4) Flange Hex Bolt, M6-1.0 x 35mm LG, (1) Mounting Bracket
- Compatible with Polaris ATV racks and UTV Bed-Rails with (2) Polaris Lock & Ride Compatible Anchors (98500/98510) sold separately



20710



## KOLPIN STRONGHOLD AUTO-LATCH MOUNT

- Auto-latching design provides quick secure attachment for all Kolpin Stronghold products
- Spring loaded latch with stainless steel spring
- Durable glass-reinforced nylon auto-latch construction
- Includes u-bolts and mounting hardware



30816

## KOLPIN STRONGHOLD UTV DOUBLE BED RAIL MOUNT

- Provides quick & secure attachment for (2) Kolpin Stronghold Boots
- Telescoping steel bar mount installs in/on UTV beds from width 41" to 55 1/2"
- Includes (2) adjustable Kolpin Stronghold Auto-Latch mounts
- Precision horizontal & pivoting adjustment to optimize boot installation
- Lock & Ride mountable to Polaris Ranger/General with optional mounting kit 53504 or (4) 98510 anchors
- Lock & Ride mountable to Polaris XPEDITION XP with optional mounting kit 53505
- Does NOT fit Polaris XD 1500



20000





# CLASSIC GUN BOOTS

## THE GUN. THE BOOT. THE LEGEND.

Evolved from the Kolpin 007, originally built in the early 1970s, the Classic Gun Boot family has established a following as extensive and storied as the thousands of adventures they've been carried on to every corner of the globe.

We additionally have a full assortment of brackets to mount the Boots to your type of vehicle.

### GUN BOOT 6.0 - IMPACT

- Fits firearms up to 51" in total length
- Extra room for pistol grips & small bi-pods
- Hatchback easy access and locking capability
- Ergonomically designed handle & molded attachment points for a sling
- Compatible with 20005, 20006, 20029, 20032, 20033, 20035, 20200, 20350, 20351 (sold separately)
- Includes a removable padded protective liner that provides superior interior protection
- Dimensions: 51" L x 4 1/2" W" x 9" H



### 20025

### GUN BOOT IV

- The most popular gun case for almost 50 years
- Provides ample room for 50mm scopes, rifles with slings or shotguns up to 51" in length
- Includes a removable padded protective liner that provides superior interior protection
- Ergonomically designed handle & molded attachment points for a sling
- Designed to accommodate left & right hand bolt action rifles & shotguns
- Compatible with mounts 20032, 20035, 20351, 20350, 20200 (sold separately)



### 20051

### GUN BOOT 4.3 WITH BRACKET

- Provides ample room for 50mm scopes, rifles with slings or shotguns up to 51" in length
- Includes both a Gun Boot with protective liner and mounting bracket
- Designed to accommodate left and right hand bolt action rifles and shotguns
- Ergonomically designed handle and molded attachment points for a sling
- Mounting hardware included for most installations



### 20053

### BOOTTECTOR BRACKET

- Interfaces with: Gun Boot L, Chainsaw Boot and Gun Boot 6.0
- Includes Mounting Hardware
- 20035 includes U-bolt mounting hardware for ATVs with tubular racks



20035  
POLARIS SPORTSMAN - 20350  
POLARIS RANGER - 20351

### GUN BOOT LOOP BRACKET

- Interfaces with: Gun Boot L, Chainsaw Boot and Gun Boot 6.0
- Includes Mounting Hardware
- 20032 includes U-bolt mounting hardware for ATVs with tubular racks



20032  
POLARIS SPORTSMAN - 20033

### GUN BOOT / SAW BOOT BRACKET

- Interfaces with: Gun Boot L, Chainsaw Boot and Gun Boot 6.0
- Fits ATV tubular racks or UTV frames up to 2"
- Includes Mounting Hardware



20200

### IN-BED DOUBLE GUN BOOT 6.0 MOUNT

- Mounts (2) Gun Boot 6.0 cases in UTV bed
- Bed width dimensions must be between 47 1/2" to 55"
- Includes Mounting Hardware



20005

### POLARIS FULL-SIZE RANGER IN-BED SINGLE GUN BOOT MOUNT

- Mounts (1) Gun Boot 6.0 case in bed
- Compatible with 2005 - Current Polaris Full-Sized Rangers with (2) included 98510 anchors



20006

### GUN BOOT ONE-PIECE BRACKET

- Mounts to tubular ATV racks to transport Gun Boot 4 and 6.0 cases
- Perfect fit for intermediate & smaller ATVs
- Includes Mounting Hardware



20029



# GUN & GEAR TRANSPORT | CARRIERS SAW-TRANSPORT

Transport your gun or chainsaw securely and safely on most ATVs or UTVs.

Whether in a Chainsaw Mount or Gun Boot, we have a solution to securely transport your gear on your ATV or UTV.

QUICK &  
EASY  
ACCESS

SAW TRANSPORT



CARRIERS





**UTV VERTICAL IN-CAB GUN RACK**

- Vertical in-cab gun rack mounts to UTV floor
- Standard mount fits flat UTV floors; other specific adapter plates may be required
- Fully adjustable angling up to 45°
- Adjustable height from 27 1/2" to 35 1/2"
- Base dimensions: 5 1/4" W x 6" L front to back

**UTV GUN RACK - 20073**  
**REPLACEMENT STRAPS (PAIR) - 70732**  
 • 8 1/4" long

**ADAPTER MOUNTS**

**CENTER TRANSMISSION HUMP RISER MOUNT - 20074**  
 • Fits the following models:  
 2005-2013 Yamaha® Rhino  
 2006-2008 Polaris Ranger 500/700

**RANGER MID-SIZE MOUNT - 20077**  
 • Fits the following models:  
 2011-2022 Ranger 500 / Crew  
 2014-2019 Ranger 570 / Crew



**UTV DOUBLE GUN SOFT CASE**

- Fits (2) scoped-rifles or shotguns up to 52" in length
- Water/dust-resistant ballistic fabrics & zippers
- Thick padded construction
- (2) large exterior gear storage pockets
- (6) quick-release buckle mounting straps for fitment to most UTV roll cages
- Exterior dimensions: 52" x 10 1/2" x 6"



**UTV GUN CARRIERS**

**EASY ACCESS. NEVER TOO FAR AWAY.**

Whether vertically mounted between driver and passenger, overhead or to the roll cage, we have a solution to securely transport 2 rifles or shotguns on your UTV.

**BLACK - 20830**  
**PURSUIT CAMO - 20831**



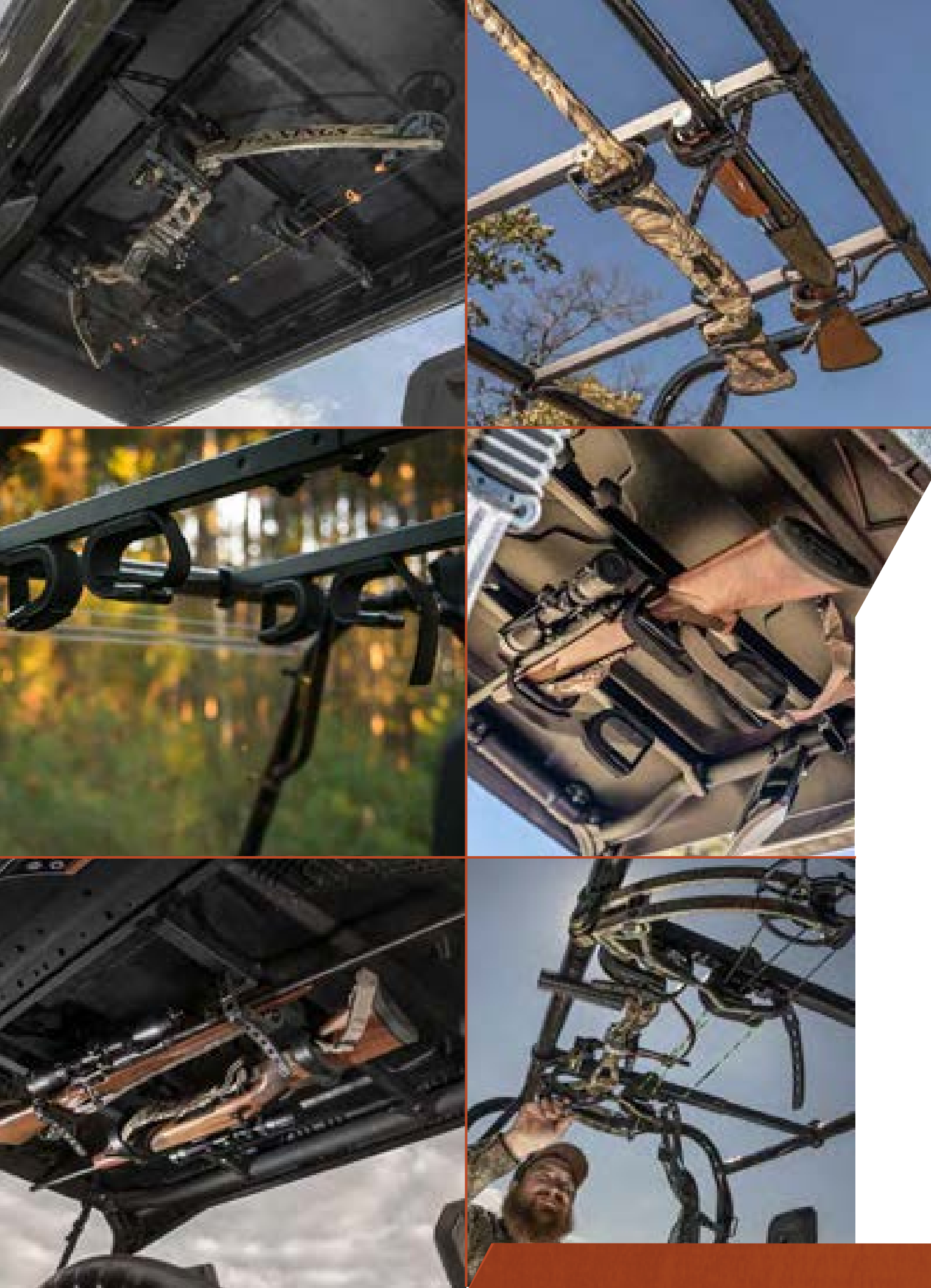

### UTV OVERHEAD IN-CAB GUN RACK

- Adjustable length 20 1/2" to 28 1/2" to fit many UTV models (inside of UTV frame)
- Designed to hold two firearms
- Rubber-coated ends protect the frame
- Foam padding protects your firearms and provides a secure fit
- No tools required for assembly — easy on, easy off



20078 (PAIR)

### UTV OVERHEAD IN-CAB GUN & BOW RACK

- In-cab overhead rack secures and protects (2) guns or (1) bow
- Adjustable firearm grips can be positioned to optimize firearm location and orientation
- Rubber strap offers quick, adjustable and silent access to firearms or bow
- Scratch-resistant, foam-lined grips with rubber straps provide secure protection for exposed firearms encased in soft-sided cases or compound bows.
- Ultra-strong steel telescoping tubes adjust from 17 1/2" to 33 1/2"
- Installs in minutes - no vehicle modification required
- Fits UTVs with 1 1/2" to 2" round cages as well as profile tube (Polaris/Can-Am®)



20079 (PAIR)



# SAW TRANSPORT

## TRANSPORT YOUR CHAINSAW SECURELY AND SAFELY ON ANY ATV, UTV OR TRAILER

Whether using a Saw Press or Saw Boot, traverse rough terrain with your chainsaw mounted to your vehicle.

### UTV/TRAILER CHAINSAW MOUNT

- Heavy-duty, black powder-coated metal bracket designed to transport your chainsaw safely and securely
- Rubber pads provide cushioning and a snug fit
- Hinged design allows for quick removal
- Holds a chainsaw or round-handled tools vertical or at a 45° angle
- Accommodates any brand chainsaw with up to a 22" bar
- Fits UTV beds, ROPS, and trailers
- Includes ROPS and bed mounting hardware

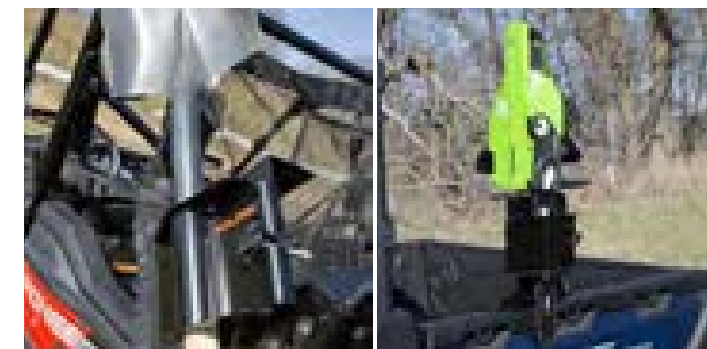

20048

### POLARIS RANGER/GENERAL CHAINSAW MOUNT

- Heavy-duty, black powder-coated metal bracket designed to transport your chainsaw safely and securely
- Rubber pads provide cushioning & a snug fit
- Hinged design allows for quick removal
- Holds a chainsaw or round-handled tools vertically or at a 45° angle
- Accommodates any brand chainsaw with up to a 22" bar
- Fits Polaris Ranger/General UTV beds with included Polaris Lock & Ride compatible anchors
- Does not fit Polaris XD 1500 or Polaris XPEDITION



POLARIS RANGER/GENERAL 20049



### ATV CHAINSAW MOUNT

- Heavy-duty, black powder-coated metal bracket designed to transport your chainsaw safely and securely
- Rubber pads provide cushioning & a snug fit
- Hinged design for quick removal
- Holds saw in vertical position or at a 45° in either direction
- Accommodates any brand chainsaw
- Fits round-handled tools
- Compatible with most ATVs with tubular racks and trailers
- NEW and IMPROVED fitment for Can-Am® Outlander and Polaris Sportsman

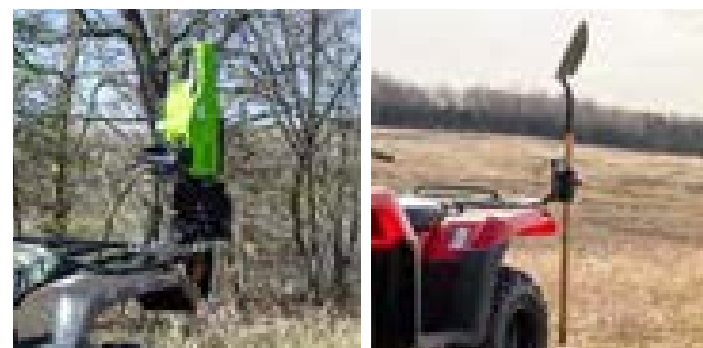

20044

### CHAINSAW BOOT

- Secure & protect your chainsaw when traversing rough terrain
- Fits chainsaws with up to a 20" bar
- Compatible with standard Kolpin Gun Boot brackets - Simply remove your Gun Boot case & install the Saw Boot
- Compatible with Kolpin Loop Brackets (20032, 20033), Bootector Brackets (20035, 20350, 20351) and Boot/Saw Bracket (20200)
- Chainsaw can be quickly secured or removed using the included bungee tie-down
- Includes heat shielding for safe transport of a hot saw
- Fits most ATVs with tubular racks, UTV beds and trailers - See mounting solutions on page 44 for details



20600

Chainsaw not included

# STORAGE & ACCESSORIES

## HARD STORAGE SOFT STORAGE RACKS

For 80+ years, it's been our obsession to help outdoorsmen and women transport their essential gear safely and securely.

Whether on the trails or on the farm we have multiple ways to solve your storage needs. From metal racks to storage boxes and bags, our products are made to safely and securely protect your essential gear.

**DRY &  
DUST-FREE  
TRANSPORT**





# UTV STORAGE

## KEEP YOUR GEAR ORGANIZED AND SECURE

No matter the size or weight—light or heavy, big or small—when you hit the trails, we've got a bag, box, or rack to store and transport your gear.

### UTV DIAMOND PLATE BEDSIDE SADDLE BOX

- Constructed of durable 15-gauge diamond plate aluminum with matte black powder coat finish
- Lockable stainless-steel latch
- Dimensions: 13.8" (H) x 11.1" (W) x 15.6" (L)
- 90° gas-shock assisted for easy-open lid
- Gasketed/Weatherproof Lid to keep your gear dry
- Reinforced sub-frame and full-length piano hinge for increased rigidity
- Integrated interior mounting holes allow quick mounting to vehicle bed side
- Mounting Kits sold separately:
  - Can-Am® Defender® Linq: 98515 (2)
  - Kawasaki® Mule Pro FX/FXT: 53502
  - Polaris Ranger XD1500: 98512 (2)
  - Polaris XPEDITION: 98512 (2)
  - Polaris Ranger/General: 98510 (2)
  - Yamaha® Viking®: 53502
  - CFMOTO®: 98516 (2)



53475

### MID-SIZE/CROSSOVER UTV ALUMINUM BED BOX

- Constructed of 15-gauge diamond plate aluminum with matte black powder coat
- Lockable stainless-steel latches accessible from both driver & passenger sides
- Dimensions: 11" (H) x 11.9" (W) x 54.6" (L)
- 90° gas-shock assisted (2)
- Gasketed/Weatherproof Lid with reinforced sub-frame and full-length piano hinge for increased rigidity
- Integrated interior mounting holes; compatible with Rhino Grip Flex
- Mounting Kits sold separately:
  - Can-Am® Defender® Linq: 53503
  - Polaris General: 53504
  - Polaris Ranger Mid-Size 2010+: 53504
  - Polaris XPEDITION: 53505
  - CFMOTO® UFORCE 600/800: 53506



53472

## FULL-SIZE UTV ALUMINUM BED BOX

- Full-Size UTV bed box constructed of 15-gauge diamond plate aluminum
- Lockable stainless-steel latches accessible from both driver & passenger sides
- Dimensions: 11" (H) x 12" (W) x 60" (L)
- 90° gas-shock assisted (2); Fully open when positioned at the front of the bed w/out interfering with the cab
- Gasketed/Weatherproof Lid with reinforced sub-frame and full-length piano hinge for increased rigidity
- Integrated mounting holes inside; compatible with Rhino Grip Flex
- Mounting Kits sold separately:
  - Can-Am® Defender® Linq: 53501
  - Kawasaki® Mule Pro FX/FXT: 53502
  - Polaris Ranger Full-Size 2005+: 53504
  - Polaris Ranger XD1500: 53507
  - Yamaha® Viking®: 53502
  - CFMOTO® UFORCE 1000/U10 Pro: 53506

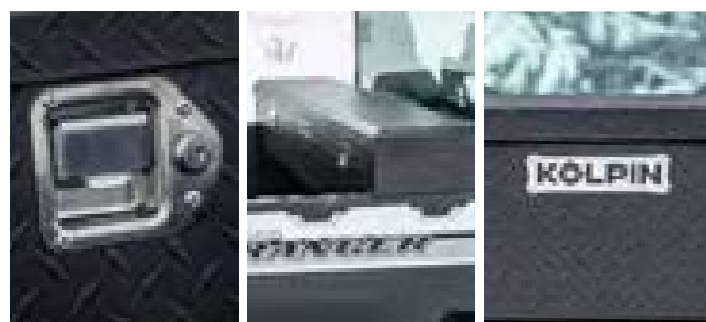

53470

## BED BOX MOUNTING KITS

**CAN-AM® DEFENDER® LINQ® MOUNTING KIT 53501**



**KAWASAKI®/YAMAHA® TUBE MOUNTING KIT 53502**



53502  
x (4)

**POLARIS RANGER/GENERAL LOCK & RIDE MOUNTING KIT 53504**



**CFMOTO® MOUNTING KIT 53506**



53506

**POLARIS RANGER XD 1500 LOCK & RIDE MAX MOUNTING KIT 53507**



## UTV OVERBED STORAGE RACK

- Heavy-duty bed rack for gear storage
- 7" elevation above bed rail to maximize storage
- 150 lb. weight capacity for off-road vehicles
- Adjustable from 39 7/10" to 56 3/10" (inside bed widths)
- Fully welded steel basket: 46 2/5" x 20" x 4 1/5"
- Integrated mounting pattern compatible with Kolpin Rhino Grips (XL, XLR, Pro, Flex) and Kolpin Stronghold Mount (30816)
- Integrated tie-down and chainsaw bar slots
- Quick 5-minute assembly with pre-drilled holes
- Model specific mounting hardware sold separately (see below)
- See kolpin.com for complete fitment list

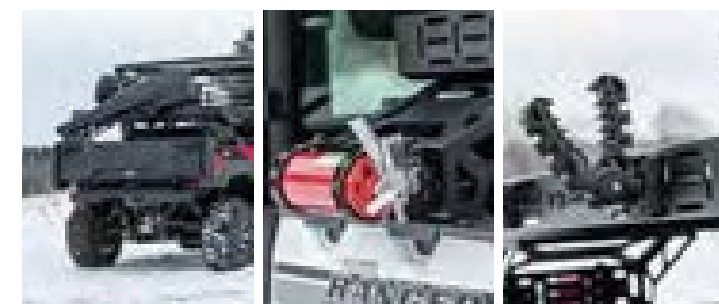

53450

## UTV OVERBED STORAGE RACK MOUNTING KITS

MAKE	MODEL	YEAR	MOUNTING KIT
CAN-AM®	Commander®	2021+	53503
CAN-AM®	Defender®	2016+	53503
CFMOTO®	ALL	ALL	53506
HONDA®	Pioneer® 500, 520	2015+	53502
JOHN DEERE®	XUV 625, 825, 855, 835	2011+	53502
KAWASAKI®	Mule Pro FX/FXT	2015+	53502
KAWASAKI®	Mule Pro MX/SX	2017+	53502
KAWASAKI®	Mule 4000/4010	2021+	53502
KAWASAKI®	Teryx® 2 Pass	2014+	53502
POLARIS	General - All	2016+	53504
POLARIS	Ranger - All	2005+	53504
POLARIS	XPEDITION XP	2024+	53505
YAMAHA®	Viking®	2014+	53502



## 2" RECEIVER HITCH CARGO CARRIER

- Heavy-duty receiver rack for gear storage
- 8" lift for off-road clearance
- Fully welded steel basket: 46 2/5" x 20" x 4 1/5"
- Integrated laser-cut hole patterns compatible with Kolpin Rhino Grips (XL, XLR, Pro, Flex) and Stronghold 30816 Gun Boot mount
- 150 lb off-road / 300 lb on-road weight capacity
- Quick 5-minute assembly with pre-drilled holes
- 85625 2" Hitch Stabilizer included for added stability



53460

## BED STORAGE BOX - POLARIS UTV COMPATIBLE

- Provides 7 Gallon / 26 Liter of storage space
- Outside dimensions: 22" L x 12 1/4" W x 12 1/2" H
- Internal dimensions: 19" L x 8" W x 10" H
- Includes (2) UTV 98510 anchors for compatibility with Polaris UTV Bed-Rails using Lock & Ride
- Easy installation



4413

## BED STORAGE BOX

- Easy installation to inside bed rails of most utility vehicles
- Durable roto-molded construction with rear hinged lid provides long lasting performance
- Lockable latches
- Provides almost 10 gallons (39.6 Liters) of weather resistant storage
- Outside Dimensions: 27" L x 10" W x 15" H
- Internal Dimensions: 26-3/4" l x 4-3/4" w x 14-3/4" h (each)
- Does NOT fit Polaris Ranger/RZR Models
- Easy installation



4408

## UTV BENCH CENTER CONSOLE

- Easily access necessary gear
- Features a weather-resistant storage compartment with lid & two cup holders
- Heavy-duty, black roto-molded, and UV-stabilized LLDPE (linear low-density polyethylene) construction
- Overall dimensions: 21" L x 10" W x 8" H



4470

## ATV MATRIX SEAT BAG

- Durable 600D nylon construction with Hydro Shield and UV coating
- 3-piece bag design including center cooler
- 15 Gallon / 57 Liter of accessible storage
- Reinforced buckles to allow for easy on, easy off of most ATV racks
- Overall dimensions: 32" L x 22" W x 11" H
- Side Pod dimensions: 16" L x 6" W x 8" H



BLACK - 91155  
PURSUIT CAMO - 91150

## ATV GEAR & COOLER SEAT BAG

- Heavy-duty water-resistant Hydro shield & UV coated ballistic fabric, w/ padded construction
- 5 Gallon / 20 Liter cooler with (2) 4.7 Gallon / 18 Liter side compartments
- Padded seat converts to storage basket
- (2) front mesh pockets & storage cords
- (7) buckled straps for fitment to most ATV racks
- Overall dimensions: 34" L x 18" W x 11" H



BLACK - 91156  
PURSUIT CAMO - 91157

## GUARDIAN ATV/UTV STORAGE BOX - 40 L

- 10 1/2 Gallon / 40 Liter zipper-less design with water-resistant ballistic fabrics with UV coating
- Integrated dust & water seal
- 3-pocket lid organizer
- (6) metal D-ring tie-downs on perimeter
- (6) quick-release buckle mounting straps for fitment to most ATVs and UTVs
- Overall dimensions: 27 1/2" L x 11" W x 8 1/2" H



91163

## GUARDIAN ATV/UTV STORAGE BOX - 80 L

- 21 Gallon / 80 Liter zipper-less design with water-resistant ballistic fabrics with UV coating
- Integrated dust & water seal
- Zippered exterior pocket
- 3-pocket lid organizer
- (6) metal D-ring tie-downs on perimeter
- (6) quick-release buckle mounting straps for fitment to most ATVs and UTVs
- Overall dimensions: 33" L x 14" W x 12" H

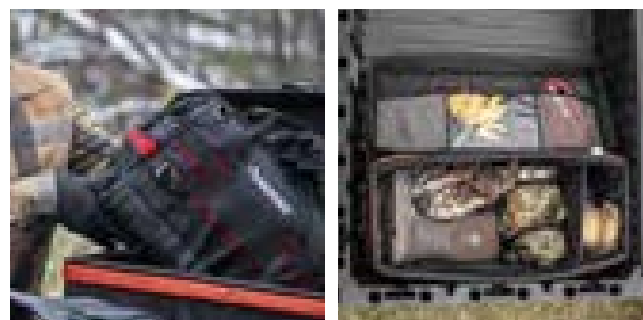

91162

## ATV TRUNK & LOUNGER

- Massive 31 Gallon / 117 Liter storage capacity
- Seamless hinge and gutter lid design closes with heavy-duty rubber latches to keep interior dry and dust free
- Easy to attach / remove from vehicle via U-bolt kit (included)
- Recessed utility tray with integrated tie downs
- Durable roto-molded construction with integrated pad lock holes
- The underside of the lid has integrated mounting holes inside; compatible with Rhino Grip Flex
- Removable no-slip pads
- Overall dimensions: 40 3/4" L x 28" W x 17" H



4457

**CAN-AM® OUTLANDER MOUNTING KIT - 93165**



**POLARIS SPORTSMAN MOUNTING KIT - 93160**



Rhino Grip Flex (sold separately)

## ATV REAR HELMET BOX

- Mounts to most tubular racks using (4) U-bolts and sealing washers (included)
- 93165 and 93160 Mounting Kits do not work for this box
- Opens in the rear with access to arm cavities
- 26 Gallon / 99 Liter of weather-resistant storage
- Overall dimensions: 36 3/4" L x 28" W x 17" H

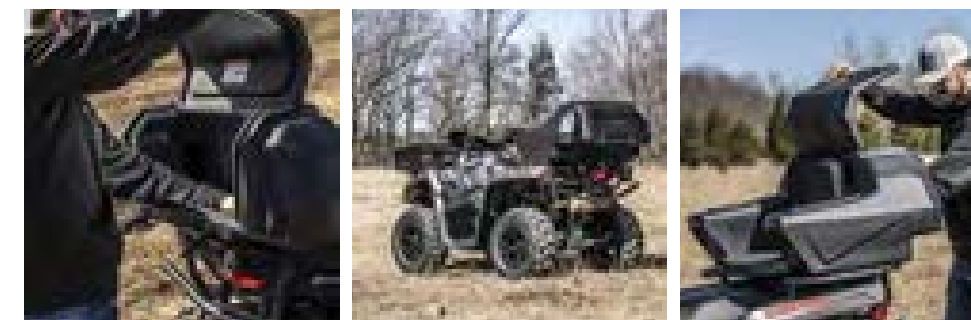

4438



## ATV FRONT RACK STORAGE BOX

- Contoured design for maximum visibility
- Double-walled lid construction
- Heavy-duty keyed lockable center latch
- Overall dimensions:  
30 ¼" L x 13 ½" W x 9" H

**93101**

### POLARIS MOUNTING KIT - 93103

- Required for 2005-current Polaris ATVs with Lock & Ride
- Mount kit includes (2) mounting brackets & (4) 98500 Lock & Ride anchors

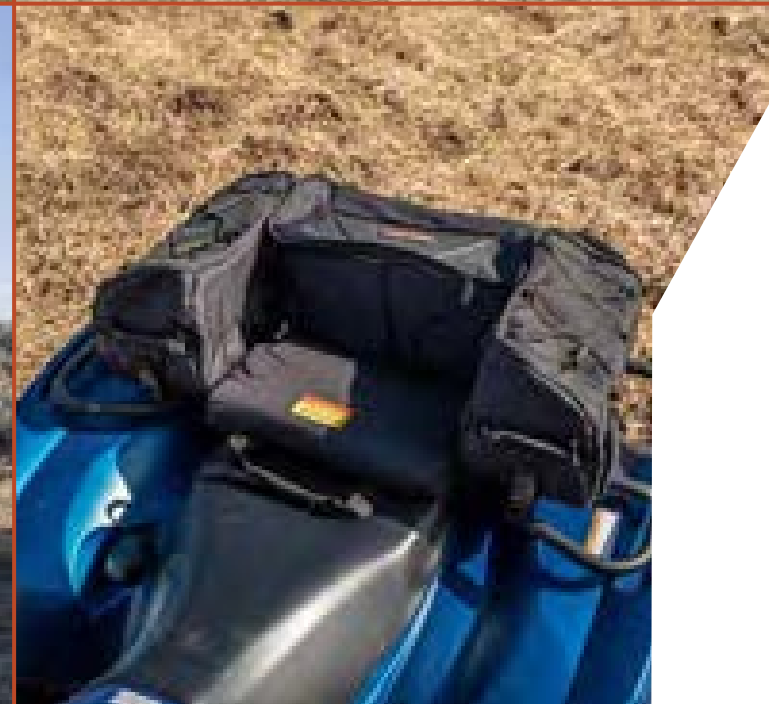

## ATV REAR RACK STORAGE BOX

- Lockable box
- Double-walled lid construction
- Overall dimensions:  
37" L x 17 ½" W x 13 ½" H

**93201**

### POLARIS MOUNTING KIT - 93203

- Required for 2005-current Polaris ATVs with Lock & Ride
- Mount kit includes (2) brackets & (2) 98500 ATV Anchors, (1) Kwik-Cinch Strap



### ACCESSORY RACK - 93202

## ATV REAR RACK OUTFITTER BOX

- Double-walled lid construction
- Rubber sealing gasket to keep out dust/water
- Kwik-Cinch straps for quick on/off attachment
- Metal Accessory Rack for extra capacity
- Fits most ATV racks
- Lockable
- Overall dimensions:  
42 ½" L x 21 ½" W x 16 ¾" H
- Front to back base footprint: 13" in the center between the rear of the seat to the rear of the rack, 19" on the outside edges

**93450**





# ATV RACKS

## BUILT FOR THE TOUGHEST JOBS

ATVs are among the most versatile vehicles out there—used everywhere from farms to job sites to oil fields.

When you need to expand your machine's capacity or add the rugged durability of metal to your storage setup, our lineup of ATV racks delivers the strength & reliability to transport & protect your gear.

### ATV RACK BASKET

- Steel sheet construction with powder-coated finish; includes standard mounting hardware
- Integrated hole pattern for mounting Kolpin Stronghold Auto-Latch (30816) and Gun Boots or Kolpin standard-style Rhino Grips
- Compatible with Polaris Sportsman Lock & Ride & Can-Am Outlander LinQ with appropriate anchors (98500/98515) sold separately
- Designed to hold (3) 5 gal. buckets
- Fits most ATV tubular steel and plastic racks
- Does not fit Touring model rear racks
- Dimensions: 39.1" x 12.4" x 6.6"



53465

### ATV FLAT RACK

- 1 ½" steel tubing for perimeter support
- Expanded metal mesh to contain small items
- Mounts to front or rear tubular rack of ATV
- Flat design increases rack space
- 1 ¼" space at 16" allows fitment to machines with vertical rack loops
- Dimensions: 40" L x 33" W x 6" H, 20 lbs.
- Designed to fit most ATV's with tubular steel racks



53400

### ATV RACK GEAR BASKET

- Add extra front or rear ATV storage
- Space to carry up to (3) 5-gallon buckets
- Fits most front or rear tubular rack
- Dimensions are 38" L x 13" W x 7 ½" H, 16 lbs.
- Designed to fit most ATV's with tubular steel racks



53360

### ATV REAR DROP BASKET WITH TAILGATE

- Includes fold down tailgate & cable supports, basket weight capacity up to 200 lbs.
- Inside box dims: 37 ½" L x 12" W x 8" H
- 1 ¼" space 16" before drop allows fitment on machines with vertical rear rack loops
- Basket dimensions: 38" L x 13" W x 7 ½" H, 16 lbs
- Dimensions: 43" L x 31" W x 10" H, 51lbs.



53300

### ATV CONVERTIBLE REAR DROP BASKET RACK

- Basket can be used with rear rack extension in dropped or raised position or separately for contained storage on your ATVs front rack
- Constructed of 1 ½" diameter tubing
- 1 ¼" space before drop allows fitment to machines with vertical rear rack loops
- Basket dimensions: 38" L x 13" W x 7 ½" H, 16 lbs
- Dimensions: 40 ½" L x 27 ¼" W x 10" H, 28 lbs.



53350

# DIRT WORKS

## CATEGORY "0" AGRICULTURAL IMPLEMENTS

Kolpin category "0" implements put your ATV or UTV to work.

Whether prepping a food plot to attract the biggest of bucks, or cultivating your acreage to put veggies on the table, the Kolpin DirtWorks system has all the needed implements to plow, rake, scrape and more.



PUT  
FOOD  
ON THE  
TABLE



# BUILD YOUR SYSTEM

The DirtWorks system is built to be easy.

Find the hitch that works with your machine.

Attach the 3-Point Hitch with appropriate Accessory bar.

Attach the implement you need.

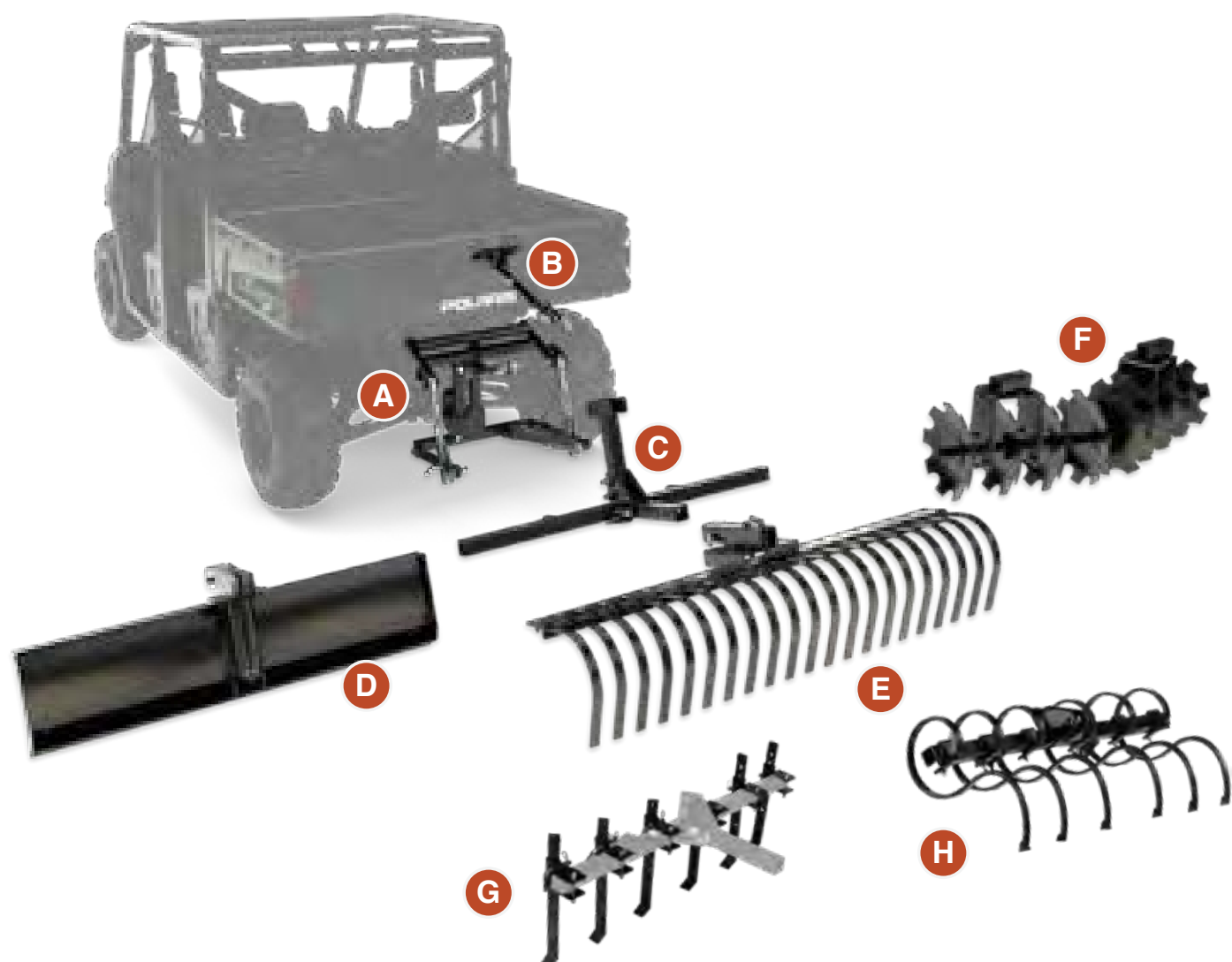

## BUILD YOUR DIRTWORKS SYSTEM

**A** 3-POINT HITCH SYSTEM  
WHS03HD

**B** OPTIMIZE PERFORMANCE  
SEE PAGE 76-83 FOR HITCHES  
AND FRAME SUPPORTS

**C** ACCESSORY TOOL BAR  
48" WIDTH - ATB48  
60" WIDTH - ATB60

## CHOOSE YOUR IMPLEMENTS

**D** REAR BLADE  
48" WIDTH - FRB48  
60" WIDTH - FRB60

**E** LANDSCAPE RAKE  
60" WIDTH - LSR60

**F** DISC PLOW  
DP82

**G** CHISEL PLOW/  
SCARIFIER  
86100

**H** S-TINE  
CULTIVATOR KIT  
CT036

## 3-POINT HITCH SYSTEM

- Category "0" Agricultural Implement System
- 20" integrated tool bar with 5/8" diameter pins
- Heavy-duty 1-1/2" square-tubing frame
- Fits any 2" automotive style receiver hitch
- Convenient rocker switch can be mounted to your handle bars/dash
- 12v electric actuator lift system with 20 amp maximum draw
- 250 lbs. lift capacity at the tool bar
- 300 lbs. down pressure capacity
- 15" vertical lift at the tool bar
- Fully adjustable lift arms & top link
- Additional frame support kit may be required, please check out our suspension locks & frame support kits (page 78)
- Requires Accessory Tool Bar (sold separately)



WHS03HD

## ACCESSORY TOOL BARS

- Category "0", 5/8" hitch pins with 20" spacing
- Heavy-duty powder-coated steel construction
- Allows quick change from one implement to another
- Required to attach any DirtWorks Implements to the 3-Point Hitch System



**48" WIDTH - ATB48**

- For use on ATVs or UTVs

**60" WIDTH - ATB60**

- For use on UTVs

## 60" LANDSCAPE RAKE

- Clear trails, groom horse corrals, rake the beach or maintain your gravel driveway
- 5-position angling for customized results
- 21 individual 1-<sup>5</sup>/<sub>16</sub>" hardened landscape rake tines
- Requires either the 48" or 60" Accessory Tool Bar & 3-Point Hitch System (sold separately)
- 60" total width



## LSR60

### DISC PLOW KIT

- Our best selling DirtWorks implement
- Two individual gangs of (4) discs easily attach to the DirtWorks Accessory Tool Bar
- Five adjustable cutting angles accommodate different soil types & conditions
- Live axle & sealed ball bearing design
- Requires the 48" or 60" Accessory Tool Bar & 3-Point Hitch System (sold separately)
- 54" total width, Disc diameter: 14"
- Helpful Hint: We recommend the use of a separate Accessory Tool Bar for mounting convenience of the disc plow set if you are utilizing other DirtWorks implements

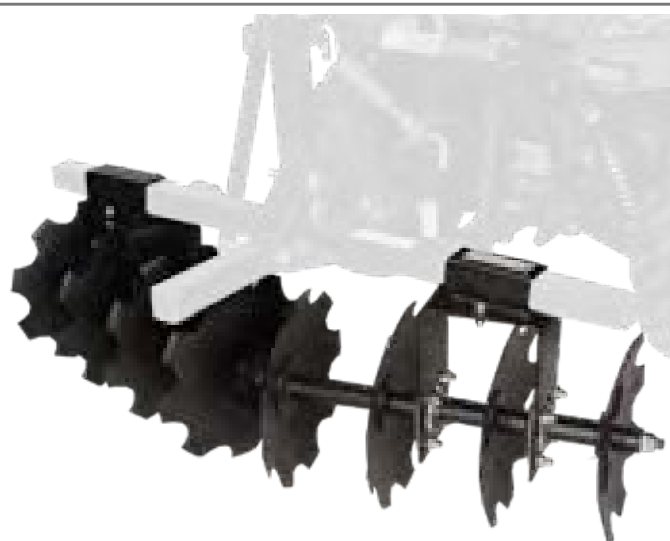

## DP82

### S-TINE CULTIVATOR KIT

- Cultivator tines break up compacted ground providing deeper penetration & more aeration when preparing your soil
- (6) 1-<sup>1</sup>/<sub>2</sub>" Agricultural grade Danish "S" tines feature reversible sweeps
- Requires the 48" or 60" Accessory Tool Bar & 3-Point Hitch System (sold separately)
- Helpful Hint: We recommend the use of a separate Accessory Tool Bar for mounting convenience of the cultivator set if you are utilizing other DirtWorks implements



## CT036

## CHISEL PLOW/SCARIFIER KIT

- 2-in-1 – Blade Scarifier OR Chisel Plow
- (6) 1/2" heavy-duty, hardened steel plow teeth to loosen hard packed surfaces such as driveways
- Adjustable blade height for various ground types & extra clearance during transportation
- Requires the 48" or 60" Accessory Tool Bar & 3-Point Hitch System (sold separately)
- Helpful Hint: We recommend the use of a separate Accessory Tool Bar for mounting convenience of the chisel plow/scarifier kit if you are utilizing other DirtWorks implements

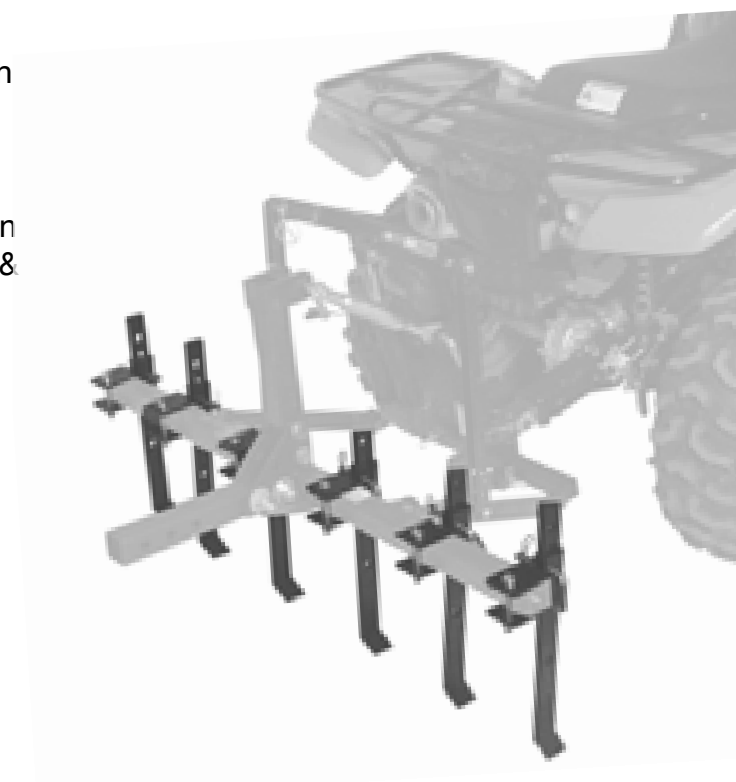

## 86100

### REAR PLOW BLADES

- 5-position angling
- 13" blade height
- Replaceable/Reversible wear bars available
- Requires the 48" or 60" Accessory Tool Bar & 3-Point Hitch System (sold separately)
- Easy one pin mounting



## FRB48 - 48"

## FRB60 - 60"



# RECEIVER HITCH ACCESSORIES

## EXTRA STRENGTH AND CAPACITY TO CARRY AND PULL A LOAD

Our new lineup of Hitch Accessories is built to lend a hand when the job demands it.

## 2" RECEIVER HITCH CARGO CARRIER

- Heavy-duty receiver rack for gear storage
- 8" lift for off-road clearance
- Fully welded steel basket: 46-2/5" x 20" x 4-2/5"
- Integrated laser-cut hole patterns compatible with Kolpin Rhino Grips (XL, XLR, Pro, Flex) and Stronghold 30816 Gun Boot mount
- 150 lb off-road / 300 lb on-road weight capacity
- Quick 5-minute assembly with pre-drilled holes
- 85625 2" Hitch Stabilizer included for added stability

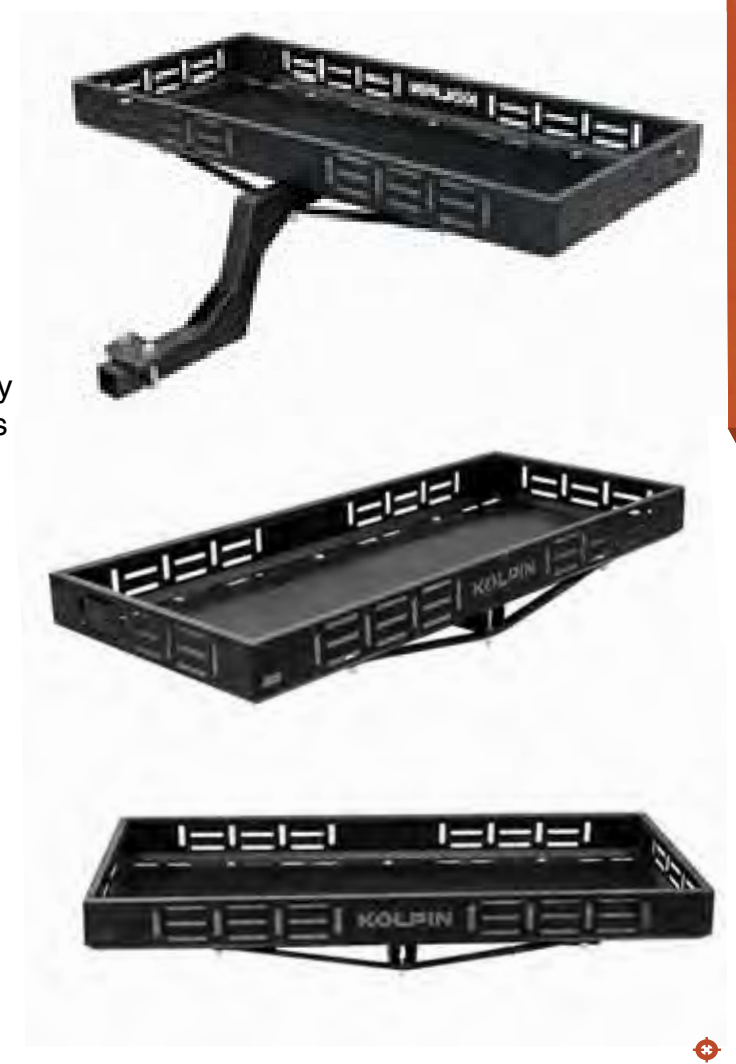

53460

## 2" HITCH STABILIZER

- Can be added to any 2" hitch to stabilize hitch-mounted accessories
- Heavy-duty 5/16" (8mm) thick steel support plate
- Oversized M12 hardware with lock washers & lock nuts for added security
- Quick and simple bolt-on installation



85625

## 2" RECEIVER SHACKLE

- Heavy-Duty forged steel construction for vehicle tow and recovery
- 9,500 lb working load limit (4-3/4 tons)
- Shackle installs horizontally or vertically
- For off-road use only
- Hitch pin included



85680

## ATV INDEPENDENT REAR SUSPENSION LOCKOUT

- Locks suspension out & mimics solid rear axle
- Improves workability of attachments
- Fits most ATVs with independent rear suspension
- Does NOT fit ATVs with curved A-Arms
- Recommended for ATV independent rear suspensions when using 3-Point Hitch System or any heavy load.



85200

## UTV 3-POINT HITCH SYSTEM FRAME SUPPORT BAR

- Add frame support and stability
- Transfers torque load from the hitch to your frame for long lasting durability
- Easy to make adjustments and take on/off
- Recommended for any UTV when using 3-Point hitch system for improved functionality of implements
- Does not fit 2020 and newer Polaris Ranger 1000



90500

## POLARIS RANGER XP 3-POINT HITCH SYSTEM FRAME SUPPORT BAR

- Add frame support and stability
- Transfers torque load from the hitch to your frame for long lasting durability
- Easy to make adjustments and take on/off
- Recommended for specific Polaris Rangers when using 3-Point hitch system for improved functionality of implements
- Fits all 2013 and newer Polaris Ranger XP 570, Ranger XP 900 and Ranger XP 1000
- Does not fit 2020 and newer Polaris Ranger 1000
- Does not fit Polaris Ranger XP Kinetic



90506

## ATV 2" IRS RECEIVER HITCH

- Fits most ATV models with Independent Rear Suspension
- Mounts directly to ATV frame
- Powder-coated steel construction
- For off-road use only
- When used with Cargo Carrier Basket (53460) limit trail riding speeds to 15mph or less. If used with Cargo Carrier Basket, limit cargo load to 50 lbs. or less.



85100

## POLARIS SPORTSMAN/SCRAMBLER 2" IRS RECEIVER HITCH

- Fits 2010-2026 Polaris® Sportsman 550 / 850 / 1000 and 2013-2026 Scrambler 850 / 1000 models
- Mounts directly to ATV frame
- Powder-coated steel construction
- For off-road use only
- When used with Cargo Carrier Basket (53460) limit trail riding speeds to 15mph or less. If used with Cargo Carrier Basket, limit cargo load to 50 lbs. or less.



85195

## POLARIS RANGER 2" FRONT RECEIVER HITCH

- Fits 2018-2026 Polaris Ranger 1000 / XP 1000 models
- Mounts directly to vehicles front frame, access through bumper opening
- Powder-coated steel construction
- For off-road use only
- When used with Cargo Carrier Basket (53460) limit trail riding speeds to 15mph or less. If used with Cargo Carrier Basket, limit cargo load to 50 lbs. or less.



85705

## POLARIS RZR XP 2" RECEIVER HITCH

- Fits RZR XP chassis with 12mm rear control arm upper and lower bolts, 2018-2021 RZR RS1, 2018-2024 RZR XP 1000, 2018-2021 RZR XP Turbo, 2018-2024 RZR XP 4 1000, 2018-2021 RZR XP 4 Turbo, 2024-2025 RZR XP / RZR XP 4 1000
- For off-road use only
- Compatible with OEM rear bumpers

85710



\*\*

## ATV/UTV - 3-WAY 2" RECEIVER HITCH WITH 2" BALL

- Integrated 2" Ball Mount, reinforced tow loop & hole for clevis pin or 2" ball.
- 3" Rise for optimal towing height
- C-Channel Design & Steel construction provides strength and durability
- For most ATVs/UTVs with 2" Hitch
- For off-road use only

85665



\*

## 3-WAY 1 1/4" MULTI-PURPOSE

- Heavy-duty draw-bar fits 1 1/4" factory receiver hitch
- Designed to accept 3/4" shaft trailer ball and 5/8" clevis
- For off-road use only

85610



\*

## 3-WAY 2" MULTI-PURPOSE

- Heavy-duty draw-bar fits 2" factory receiver hitch
- Designed to accept 3/4" shaft trailer ball and 5/8" clevis
- For off-road use only

85620



\*

## 3-WAY BOLT-ON MULTI-PURPOSE

- Fits most ATVs with factory tow ball hitch
- Designed to accept 3/4" shaft trailer ball and 5/8" clevis
- Powder-coated steel construction
- For off-road use only

85630



\*

## BOLT-ON RECEIVER HITCH

- Fits most ATVs with factory tow ball hitch
- Designed to accept 3/4" shaft trailer ball and 5/8" clevis
- Powder-coated steel construction
- For off-road use only

85640



\*

## ATV/UTV - 3-WAY 1 1/4" HITCH WITH 2" BALL AND HOOK

- Integrated 2" Ball Mount, reinforced tow loop & hole for clevis pin or 1 7/8" ball
- 3" Rise for optimal towing height
- C-Channel Design & Steel construction provides strength and durability
- For off-road use only

85675



\*

## HONDA® IRS ATV 2” RECEIVER HITCH

- Fits Independent Rear Suspension chassis 2009-2024 Rancher® TRX420 IRS, 2015-2019 Foreman® TRX500 IRS, 2015-2019 Rubicon® TRX500 IRS, 2020-2026 Rubicon® TRX520 IRS, 2003-2005 Rincon® TRX650 IRS, 2006-2024 Rincon® TRX680 IRS, 2025 Rubicon TRX700 IRS
- For off-road use only

85130



\*\*

## HONDA® 2” STRAIGHT-AXLE ATV 2” RECEIVER HITCH

- Fits Straight-Axle rear suspension chassis 2002-2004 Foreman® TRX450 FE/FM, 2005-2019 Foreman® TRX500, 2020-2026 Foreman® TRX520, 2000-2006 Rancher® TRX350 FE/FM/TE/TM, 2004-2007 Rancher® TRX400, 2007-2026 Rancher® TRX420, 2001-2014 Rubicon® TRX500
- For off-road use only

85135



\*\*

## KAWASAKI® 2” STRAIGHT-AXLE SWINGARM HITCH RECEIVERS

- Fits non-independent rear suspension 2002-2013 Kawasaki® 360 Prairie models, 2005-2013 Kawasaki® 650 Brute Force® models & 2002-2006 Kawasaki® 650 / 700 Prairie models
- Also fits non-independent rear suspension 2004-2005 Suzuki® 700 Twin Peak models
- For off-road use only

85160



\*\*

## SUZUKI® 2” STRAIGHT-AXLE SWINGARM HITCH RECEIVERS

- Fits non-independent rear suspension 2002-2007 Suzuki® 400 Eiger models, 2008-2021 Suzuki® 400 KingQuad models and 2002-2007 Suzuki® 500 Vinson models
- For off-road use only

85180



\*\*

## LOCK-IT RITE - ATV/UTV TRAILER SYSTEM

- Heavy-duty construction safely secures and prevents movement of ATVs and UTVs on trailers
- Faster and stronger than straps alone
- Easy installation & removal
- Fits 2” ball hitches
- Adjustable height, lockable
- When not in use, simply remove the upright arm, leaving only the base plate attached to the floor of your trailer
- Hardware included to fasten to wood or steel trailer beds
- Dimensions:
  - Base Plate: 16” x 8 1/2”
  - Tube Length: 18 1/2”
  - Total Height from Trailer Deck: 20”
  - Coupler Total Length: 9 1/2”

85230



## LOCK-IT RITE - ATV/UTV TRUCK RECEIVER SYSTEM

- Strongly secures and prevents movement of ATVs to truck bed with 2” receiver hitch
- Ideal for most ATVs & smaller UTVs that can fit in a truck bed
- Heavy-duty 2” square steel construction
- Incorporated trailer hitch - rated 2,000 lb towing weight and 250 lb tongue weight
- Fits most pick-up truck with 2” receiver hitch
- 2” ball coupler is faster & stronger than tie-down straps
- Lockable to prevent theft - unlike tie-down straps
- Easy installation and removal

85220



\*\*When used with Cargo Carrier Basket (53460) limit trail riding speeds to 15mph or less. If used with Cargo Carrier Basket, limit cargo load to 50 lbs. or less



### UTV SIDE MIRRORS - PORTRAIT

- Driver and passenger portrait side mirrors with tall viewing range
- Includes fold-in and break-away design with adjustable tension
- Image-stabilized convex mirror with angular adjustment to optimize for you and your vehicle
- Includes clamps to easily install to most UTVs; Fits round tubes 1 5/8 to 2" and Polaris and Can-Am® profile tubing
- Low-profile clamp compatible with most windshields and doors
- Includes a set of two mirrors (drivers and passenger side)
- Mirror dimensions: 4.9" W x 8.5" H



NEW

98320

#### UTV PORTRAIT SIDES & REARVIEW MIRROR COMBO KIT - 98322

- Includes 98310 Rear View Mirror

### UTV SIDE MIRRORS - LANDSCAPE

- Driver and passenger landscape side mirrors with wide viewing range
- Includes fold-in and break-away design with adjustable tension
- Image-stabilized convex mirror with angular adjustment to optimize for you and your vehicle
- Includes clamps to easily install to most UTVs; Fits round tubes 1 5/8 to 2" and Polaris and Can-Am® profile tubing
- Low-profile clamp compatible with most windshields and doors
- Includes a set of two mirrors (drivers and passenger side)
- Mirror dimensions: 7.8" W x 5.1" H



NEW

98325

#### UTV LANDSCAPE SIDES & REARVIEW MIRROR COMBO KIT - 98327

- Includes 98310 Rear View Mirror

## ATV & UTV MIRRORS

### ADVENTURES IN MIRROR ARE CLOSER THAN THEY APPEAR

Our full lineup of UTV and ATV mirrors are easy to mount to your machine and allow you to safely take note of your surroundings.

## UTV DUAL-VIEW SIDE MIRRORS

- Driver and passenger dual-view side mirrors
- Includes near & far lenses for wide viewing range
- Includes fold-in and break-away design with adjustable tension
- Image-stabilized convex mirror with angular adjustment to optimize for you and your vehicle
- Includes clamps to easily install to most UTVs; Fits round tubes 1 5/8" to 2" and Polaris and Can-Am® profile tubing
- Low-profile clamp compatible with most windshields and doors
- Includes a set of two mirrors (drivers & passenger side)
- Mirror dimensions: 5.5" W x 9" H



98315

## UTV SIDE & REARVIEW MIRRORS COMBO KIT

- Includes both 98310 and 98315 mirrors
- Fits UTVs with 1 5/8" to 2" diameter tubes including Can-Am® Profiles
- Safety Glass mirror lens with high-impact durable nylon housing
- Rear mirror does not fit Polaris Profile tubing
- Side Mirror dimensions: 5 1/2" W x 9" H
- Rear Mirror dimensions: 10" W x 3 1/2" H



98312

## UTV REARVIEW MIRROR

- Wide-angle scratch-resistant convex lens provides wide viewing range and image stabilization
- Double ball joint pivot arm provides maximum mirror adjustability; Tool-less T-knob adjustment
- Mounts overhead to 1 1/2" to 2" round tubes or flat drillable surfaces
- Clamp design compatible with most roofs
- Mirror dimensions: 10" W x 3 1/2" H



98300

## UTV REARVIEW MIRROR - ROUND TUBING

- Wide-angle scratch-resistant convex lens provides wide viewing range and image stabilization
- Ball joint provides unlimited viewing angles & easy, tool-less pivot adjustment
- Includes clamp and hardware to fit most UTVs; Fits round tubes from 1 5/8" to 2" round tubing
- Does not fit Polaris profile tubing
- Mirror dimensions: 10" W x 3 1/2" H



98310

## ATV REARVIEW MIRROR

- Fully adjustable 4" mirror
- Quick on/off
- Accommodates 5/8" to 1" diameter tubing



97200

## ATV HANDGUARDS WITH REARVIEW MIRROR

- Handlebar mounted 3" round rearview mirror with integrated handguards
- Mounts directly to most 7/8" ATV handlebars
- Does not fit Can-Am® with hand guards or Kawasaki® Brute Force with plastic handlebar fascia
- Sold as a pair with mounting hardware



97300



# MISCELLANEOUS ACCESSORIES

## MAKE YOUR RIDE MORE COMFORTABLE

No matter the temperature or the task, we have the durable accessories to outfit you and your ATV or UTV.

### STEALTH EXHAUST 2.0 WITH HEAT SHIELD

- Used in conjunction with your stock exhaust system to reduce noise by up to 5-7 decibels with no loss in performance
- High flow/low restriction muffler uses baffled design - no packing to burn out
- Fits most four-stroke ATVs
- Included hardware adapters designed to fit OEM tailpipes 1 3/8" to 1 1/2" in diameter
- Honda® & certain other flat or concave OEM mufflers may require an additional adapter (53520 sold separately)
- Dimensions: 12 1/4" long x 4 1/2" diameter



### STEALTH EXHAUST - 53570

#### HONDA® BOLT-ON ADAPTER - 53520

- Fits Honda® TRX 250, 300, 350, 400, 450 & other flat or concave OEM mufflers

### KOLPIN 50Q COOLER

- Strong 1-piece roto-molded construction
- Carries up to 64 cans (12oz) + ice
- Holds ice for 10 days!
- Reinforced lockable lid
- 4 cup holders with rapid drain system
- Bottle opener made of aluminum to prevent rust
- No slip rubber feet
- Engineered and Made in USA
- Product dimensions: 28.3" L x 17.3" w x 16.4" h



99050 - GRAY

99051 - GRAY & ORANGE

## ATV THROTTLE MASTER

- Eliminate fatigued or sore thumbs
- More precise throttle control
- Easy bolt-on design
- Unique design allows length adjustment



98005

## HANDY THROTTLE

- Converts thumb throttle to twist throttle without altering the mechanical function of the OEM throttle
- Eliminates thumb fatigue
- Fits on most ATVs, watercraft & snowmobiles that have a standard 7/8" handle bar & thumb throttle
- Fast, easy installation



98020

## ATV HEATED GRIPS

- Keep your hands warm and comfortable with soft heated grips
- Multiple settings for optimal temperature control
- Easy to install with fully assembled, plug-n-play electrical connectors to most ATVs or snowmobiles with 7/8" handlebar



50-0360

## SUN VISOR

- Driver & passenger tinted sun visors
- Tilts up to 220° with T-knob adjustable tension
- Adjustable panel can move to the left or right 1.6"
- Mounts to flat surfaces & round tubes from 1 1/2" to 2"
- Dimensions: 12.6" x 5.9"
- Sold as a pair



98700

90

## ATV/UTV TIRE REPAIR KIT

- Everything you need to repair and inflate multiple ATV/UTV tires
- Packed conveniently in our handy storage pouch
- Includes: (3) CO2 cartridges, Regulator/adapter tool, 4" tire seals, tire roughing tool, installation tool



89510

## ATV/UTV FLAT TIRE REPAIR PACK

- Repair Pack with pump includes all the tools to fix ATV/UTV flat tires
- Compact design for easy transport
- Easily straps to ATV/UTV racks or stores inside gear box
- Dimensions: 9 1/2" L x 3" diameter



89500

## CFMOTO® QUICK-ATTACH PLUNGER

- Quick on/off connection to base on CFMOTO® ATV/UTV systems
- Expanding rubber anchor provides a solid attachment for accessories
- Rotate T-knob to tighten or to remove accessory



NEW

98516

## CFMOTO® QUICK-ATTACH PLUNGERS KIT

- Includes (4) 98516 plunger assemblies

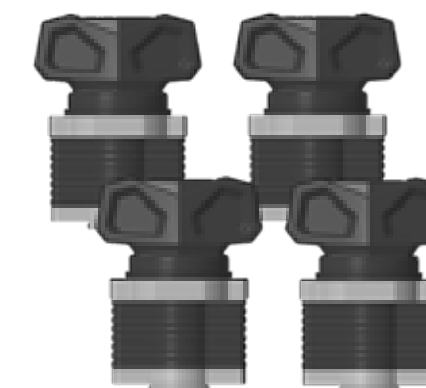

NEW

53506

### POLARIS SPORTSMAN/RZR LOCK & RIDE COMPATIBLE ANCHOR

- Quick on/off connection to Polaris Sportsman/ RZR Lock & Ride systems
- Expanding rubber anchor provides a solid attachment for accessories
- Rotate T-knob to tighten or remove accessory



98500

### POLARIS RANGER/GENERAL LOCK & RIDE COMPATIBLE ANCHOR

- Quick on/off connection to Polaris Ranger/ General bed rails using Polaris Lock & Ride systems
- Expanding 1 1/4" diameter rubber anchor provides a solid attachment for accessories
- Rotate T-knob to tighten or remove accessory
- Does not fit Polaris RZR



98510

### POLARIS LOCK & RIDE MOUNTING KIT

- Includes (4) 98510 plunger assemblies
- Does not fit Polaris RZR



53504

### POLARIS LOCK & RIDE MAX ANCHOR

- Quick on/off connection to Polaris Lock & Ride Max systems
- Rotate T-knob to tighten or remove accessory
- Includes (1) T-knob and (1) T-bolt



98512

### POLARIS LOCK & RIDE MAX ANCHORS

- Includes (4) 98512 assemblies



53505

### POLARIS LOCK & RIDE MAX RHINO GRIP MOUNTING KIT

- Easy installation - no tools required
- Includes (2) discs and (2) Polaris Lock & Ride T-nuts to allow for better connection of Rhino Grips to Polaris Lock & Ride MAX rail systems
- Prevents marring/scratching of bed rail
- Rhino Grip hardware for compatibility with Polaris Lock & Ride Max rail



21592

### CAN-AM® LINQ® MOUNT

- Quick on/off connection to Can-Am® LinQ® systems
- Expanding rubber anchor provides a solid attachment for accessories
- Rotate T-knob to tighten or remove accessory



98515

### CAN-AM® LINQ MOUNTING KIT

- Includes (4) 98515 assemblies



53503

## TRAILTEC RACK PAD

- Reduces shock & discomfort from ATV racks
- (7) Velcro® straps for easy attachment to ATV racks
- 3" open cell foam for riding comfort
- 1/2" closed cell foam on base for shock absorption
- Dimensions: 36" L x 15" W x 3" H



91880

## GEARTECTOR HANDLEBAR MITTS

- Extra large, reinforced opening for easy access to handlebars and controls
- Plush lining to keep your hands warm
- Locking draw-cord to securely seal to handlebars
- Fits virtually any ATV or snowmobile



**BLACK - 92185**  
**PURSUIT CAMO - 92180**

## CARGO SPIDER

- Customizable 6-legged cargo spider helps secure gear to off-road vehicles
- Adjustable 3' long straps with heavy-duty s-hooks allow for countless tie-down possibilities
- Premium quick-cinch cam buckles allow for tight and secure transport of your gear



95180

## UTV COVERS

- Heavy-duty water-resistant cover protects against weather, dust & debris
- Includes elastic seam and tie-down straps
- Note: Cover must be removed for trailering

**MID-SIZE - 95111**

- Dimensions: 113" L x 60" W x 70" H

**FULL-SIZE - 95113**

- Dimensions: 120" L x 63" W x 70" H

**FULL-SIZE CREW - 95115**

- Dimensions: 160" L x 63" W x 70" H



## ATV COVERS

- Light-duty storage cover with reinforced tie-down grommets
- Note: Cover must be removed for trailering

**STANDARD - 95120**

- Dimensions: 70" L x 38" W x 34" H

**XXL - 95122**

- Dimensions: 95" L x 50" W x 50" H



## ATV GEL-TECH SEAT COVER

- Stretchable fit design to accommodate most ATVs
- Gel padding & ergonomic design provides maximum cushioning & temperature control for exceptional riding comfort
- Durable Velcro® straps and easy to install, ensuring a secure fit and effortless seat cover removal
- Dimensions: 14" front, 21" back, 30" length

91855



## ATV SLIP-ON SEAT COVER

- Great fit for smaller and intermediate sized ATVs
- Constructed of 600 denier, UV-resistant fabric
- PVC-backed for waterproof and abrasion protection
- Easy to install with elastic edge & Velcro® straps
- Dimensions: 13" front, 15 1/2" back, 26" length

**BLACK - 93645**

**PURSUIT CAMO - 93640**



## PADDED ATV SLIP-ON SEAT COVER

- Protect your OEM seat with a water-resistant full wrap style seat cover
- Includes fitment for Can-Am® Outlander & Polaris Sportsman 850/1000 Seats
- Abrasion and water-resistant synthetic rubber for extended product life
- (2) buckles to tightly cinch and secure to OEM seat
- Up to 10" front x 20" back x 34" long

93646



# PLOW SYSTEMS

CLEAR  
YOUR  
PATH

Whether clearing your sidewalk, your whole driveway or the entire parking lot, Kolpin Plows have the strength and reliability to get the job cleared. Put your ATV or UTV to work!

All Kolpin Plows can easily mount to most of today's most popular machines.

CUSTOMIZE  
YOUR  
PERFECT  
PLOW

PLOW SYSTEMS & ACCESSORIES

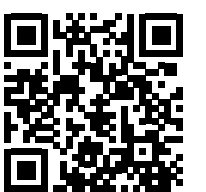



## PLOW SYSTEMS

### CONQUEROR FRONT-CONNECT PLOW SYSTEM (UTV)

- Kolpin's newest & most advanced UTV Plow
- Heavy-duty welded steel construction push frame, with 9-position blade angling
- Tool-less Quick-connection to vehicle specific front bumper mounting brackets (See page 150-167 for fitment chart)
- Capable of automated blade rotation with the addition of our Power Angle system, 33-0100 (see page 104)



### HIGH RISE (ATV)

- Kolpin's heavy-duty plow system has been designed to do what most ATV plows can't.
- The High Rise name is appropriate for this system as its dual-pivoting, articulated frame, allows for impressive blade lift height.
- Designed to be the most versatile ATV plow on the market.
- Capable of automated blade rotation with the addition of our Power Angle system, 33-0100 (see page 104)



### STORM CHASER (ATV)

- These push tubes have been pushing snow around for years, and deservedly acquired a very suiting nickname: Storm Chaser.
- They are workhorses designed with the same heavy-duty square-tube chassis as big brother, High Rise, but without the lift height or power angling capabilities.



### PLOW IN A BOX (ATV / UTV) SWITCHBLADE / EXPEDITION

- A complete plow setup in the convenience of 1 box
- Blades can be set to 1 of 2 standard widths (Switchblade only)
- Stamped reinforced 13-gauge Steel blade panels (Switchblade only)
- Includes adjustable height shoes





# CONQUEROR FRONT-CONNECT PLOW

## OUR BEST, JUST GOT BETTER

Our newest and most advanced UTV Plow combines a super-heavy-duty front-connect push frame, with a bumper mounted vehicle specific bracket.

This system provides quick, easy, and tool-less connecting/disconnecting to the front of your Side by Side.

## CONQUEROR FRONT-CONNECT PUSH FRAME

- Superior blade control with 9-position angling and up to 30" lift height
- Quick and easy plow system assembly
- Capable of automated blade rotation with the optional Power Angle (33-0100)
- Built-in height adjustment to ensure proper plow geometry for vehicles with varying ground clearances

35-0070



**2YEAR**  
PLOW WARRANTY

## PLOW BLADES

### STEEL:

- Steel blades are 17" in height
- Includes heavy-duty shoes & wear bar

48" - 31-0048      66" - 31-0066

52" - 31-0052      72" - 31-0072

60" - 31-0060

### POLY:

- Poly blades are heavier than our steel blades, with 21" tall curved profile for superior snow rolling
- Includes heavy-duty shoes & wear bar

60" - 31-2060      84" - 31-2084

72" - 31-2072



Steel Blades are e-coated & powder painted for maximum durability in extreme temperatures, salt & moisture



**2YEAR**  
PLOW WARRANTY

## FRONT-CONNECT TRACKED VEHICLE PLOW EXTENSION

- Required when UTV Conqueror plow 35-0070 is installed on vehicle with tracks
- Heavy-duty welded steel construction
- Easy installation in 30 minutes or less
- Tool-less quick-connect to vehicles

35-0350



**2YEAR**  
PLOW WARRANTY

## CONQUEROR FRONT-CONNECT PLOW MOUNTS

- Vehicle specific mounting kits install to front bumper for quick & easy installation
- The assortment of vehicle mounts are ever-expanding. Please see kolpin.com for up-to-date fitment
- Note: No mounting kit is required for some Polaris models, please see fitment chart online
- See page 150-167 for fitment chart

35-XXXX



**2YEAR**  
PLOW WARRANTY



# ATV PLOW

## ELEVATE YOUR PLOWING SKILLS

The High Rise name is appropriate for this system as its dual-pivoting, articulated frame, allows for impressive blade lift height. Plus, stacking snow and pulling On/Off of trailers is easy.

Our mid-mount under chassis design allows for maximum plowing strength and increased traction.

## ATV HIGH RISE PUSH TUBE

- Impressive lift height with Heavy-duty, Mid-mount, dual-pivot articulating frame & 20" wide blade mount platform
- Capable of automated blade rotation with the addition of the Kolpin Power Angle System (33-0100)
- 5-position blade angle adjustment
- Quick pin attachment to 15-XXXX mounts



**2**YEAR  
PLOW WARRANTY

33-0000

## ATV STORM CHASER PUSH TUBE

- Heavy-duty square-tube steel chassis with strategic reinforcements
- 20" wide blade mounting system
- Reinforced structural Pivot Box with 5-position angle adjustment
- Quick pin attachment to all 15-XXXX ATV under-body mounts



**2**YEAR  
PLOW WARRANTY

33-0070

## PLOW BLADES

### STEEL:

- Steel blades are 17" in height
- Includes heavy-duty shoes & wear bar

48" - 31-0048

66" - 31-0066

52" - 31-0052

72" - 31-0072

60" - 31-0060

### POLY:

- Poly blades are heavier than our steel blades, with 21" tall curved profile for superior snow rolling
- Includes heavy-duty shoes & wear bar

60" - 31-2060

84" - 31-2084

72" - 31-2072



← AVAILABLE IN 5 WIDTHS FROM 48" - 72" →

Steel Blades are e-coated & powder painted for maximum durability in extreme temperatures, salt & moisture



← AVAILABLE IN 3 WIDTHS 60", 72" AND 84" →

**2**YEAR  
PLOW WARRANTY

## PLOW MOUNT KITS

- Plow Mounts are required for installation of plows to every vehicle
- Designed to mount to the strongest part of your vehicles frame to provide maximum strength and traction
- See page 138-149 for fitment chart, to select the proper mount



**2**YEAR  
PLOW WARRANTY

ATV - 15-XXXX



**POWER ANGLE**

- Pivots Kolpin Blades 56° by push of button from the comfort of your seat with dash/handlebar mounted controls
- 30-minute installation with 5 bolts
- Self-locking steel gear drive isolates impact to motor and optimizes durability
- Compatible with any Kolpin Blade mounted to UTV Conqueror Front-Connect or High Rise push tubes
- Accommodates 48" to 84" blades



33-0100

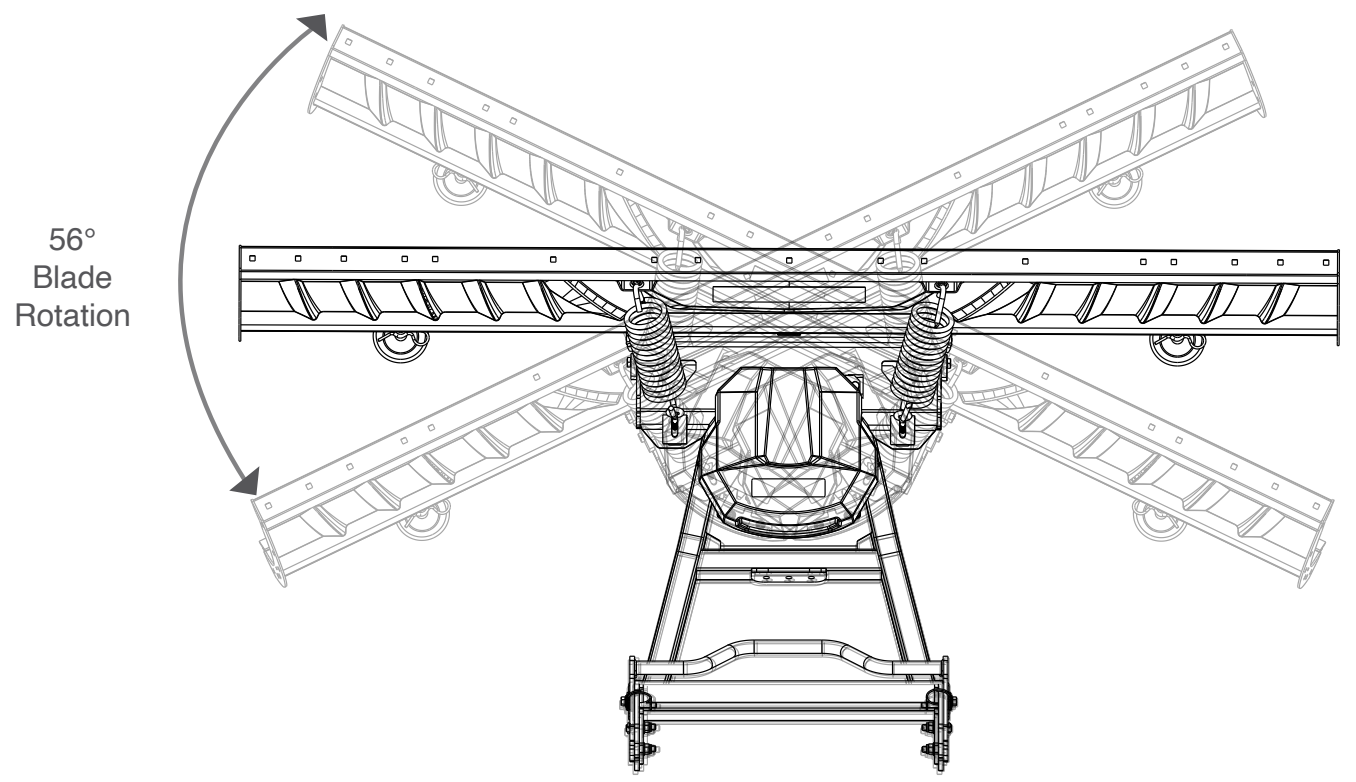

**POWER ANGLE**

**PLOW WITH PRECISION**

Pivot your Snow Plow blade with the touch of a button, from the comfort of your seat. This heavy-duty worm gear driven Power Angle is compatible with any Kolpin Snow Plow Blade mounted to either our UTV Conqueror Front-Connect or High Rise Push Tubes





# PLOW IN A BOX

## COMPLETE PLOW SYSTEM IN 1 BOX

ATV & UTV plow systems that contain everything to start plowing today in 1 box.

Blades can be set to 1 of 2 standard widths.

Winch or manual lift (15-0090) required for ATV (sold separately)  
Winch required for UTV (sold separately)

## SWITCHBLADE

- 16" high stamped steel blade technology adjusts to either 48" or 60" width (ATV); 60" or 72" width (UTV)
- Robust square-tube steel chassis with strategically placed reinforcements
- 5-position blade angle
- Easy-to-assemble and install under-body mount
- Includes adjustable height shoes
- Requires winch or ATV manual lift (sold separately)
- Assembles in under 1 hour
- ATV Box (34 1/2" L x 17 3/4" W x 8" H) , 114 lbs.; UTV Box (34 1/2" L x 18" W x 8" H), 130 lbs.
- Fits in the back of your vehicle for easy transport
- Stamped reinforced 13-gauge Steel blade panels
- Visit [kolpin.com/fitment-guides](http://kolpin.com/fitment-guides) for the most up-to-date fitment chart

ATV - 17-0000

UTV - 17-5000



**1 YEAR**  
PLOW WARRANTY

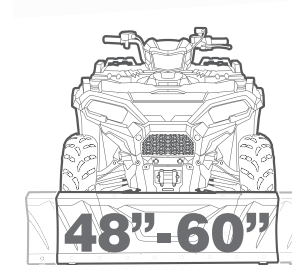

**FULLY ADJUSTABLE**  
SET TO EITHER 48" OR 60" WIDTH

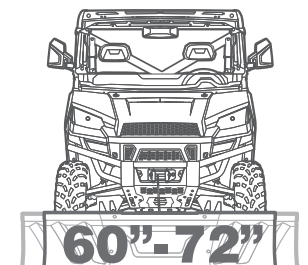

**FULLY ADJUSTABLE**  
SET TO EITHER 60" OR 72" WIDTH

## EXPEDITION

- Dual trip springs and height-adjustable HD skid shoes protect the plow and ATV
- Easy On/Easy off push tube mounting
- Rugged 52" 14-gauge steel blade with a double layer of steel at the center
- Double-sided steel wear bar that can be turned over to double the life
- Heavy-duty steel square tubed frame that will withstand years of plowing
- 5-position blade angle
- Requires winch (sold separately)
- 52" Blade (ATV)
- 70" Blade (UTV)

ATV - 10-0520

UTV - 10-5520



ATV

**1 YEAR**  
PLOW WARRANTY



UTV



# SNOW PLOW ACCESSORIES

## PLOW WITH EFFICIENCY AND COMFORT

Increase your efficiency, comfort and control with our full line up of plowing accessories.

### ATV MANUAL LIFT - UNDER BODY MOUNT

- For use with Kolpin® 33-0070
- Requires low lift effort
- Works for most ATVs
- Lift removes with the push tube, so when you're trail riding the equipment is not in your way
- You'll get at least 5 1/2" of lift with as little as 25 lbs (13 kg) of effort



15-0090

### FRONT-CONNECT TRACKED VEHICLE PLOW EXTENSION

- Required when UTV Conqueror plow 35-0070 is installed on vehicle with tracks
- Heavy-duty welded steel construction
- Easy installation in 30 minutes or less
- Tool-less quick-connect to vehicles



35-0350



### ATV TRACK EXTENSION KIT

- 11" plow extender required for Kolpin snow plow fitment to tracked ATV
- Compatible with Kolpin Storm Chaser (33-0070), Kolpin High Rise (33-0000) push tubes & Power Angle (33-0100)
- Quick & easy assembly in 15-minutes

33-0350

### SKID SHOE KITS

- Steel construction/corrosion resistant plating
- Includes (2) Skid Shoes and mounting pins

31-1255 - HEAVY-DUTY - 7MM

- Fits all Kolpin Steel blades

31-2155 - HEAVY-DUTY - 7MM

- Fits all Kolpin Poly blades



### SNOW PLOW BLADE WINGS

- Provides superior snow control and cutting while plowing
- Precision fit for Kolpin steel blades (NOT compatible with Poly or Kolpin Switchblade Plows)
- Adds 4 inches of width to your plow blade

31-0010 (PAIR)

### RUBBER PLOW BLADE FLAP

- 1/4" Thick Rubber Blade Flap fits plow blades with (cut flap to proper size)
- Keeps snow from flying into your face
- Includes hardware, drilling is required to mount to blade

10-0190 (WIDTHS 48" TO 72")

### PLOW MARKER KIT

- Increases visibility of plow edges for added safety
- Easily bolts to sides of plow blades

**KOLPIN BLADES (PAIR) - 10-0145**

- Fits all Kolpin Steel & Poly blades; 90° bend base

**STANDARD (PAIR) - 10-0140**

- Drilling may be required
- Mounts with 5/16" x 1" bolts to top outside edges of blades at 45° bend

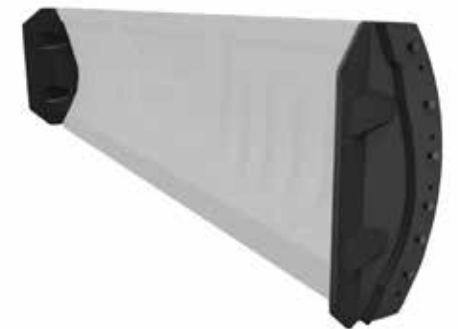

## ATV HEATED GRIPS

- Keep your hands warm and comfortable with soft heated grips
- Multiple settings for optimal temperature control
- Easy to install with fully assembled, plug-n-play electrical connectors to any standard ATV or snowmobile with 7/8" handlebar



50-0360

## GEARTECTOR HANDLEBAR MITTS

- Extra large, reinforced opening for easy access to handlebars and controls
- Plush lining to keep your hands warm
- Locking draw-cord to securely seal to handlebars
- Fits virtually any ATV or snowmobile



BLACK - 92185  
PURSUIT CAMO - 92180

## PLOW LIFT STRAP

- Durable strap designed to replace winch rope to minimize breakage due to repetitive plow blade lifting
- Wide nylon webbing design reduces binding & kinking associated with synthetic ropes & steel cables



85092

## SYNTHETIC WINCH ROPES

- 12ft, 1/4" diameter plow rope
- 39ft, 1/4" diameter rope
- 50ft, 3/16" diameter rope (85065)
- 50ft, 7/64" diameter rope (85059)



12FT - MAX WEIGHT CAP. 5500 LBS - 85075  
39FT - MAX WEIGHT CAP. 5500 LBS - 85064  
50FT - MAX WEIGHT CAP. 4000 LBS - 85065  
50FT - MAX WEIGHT CAP. 7000 LBS - 85059

## PLOW BLADE WEAR BARS

- Easy-to-install factory replacement, double-sided wear bars
- Hardware included

**STEEL BLADE HEAVY-DUTY:**  
3-GAUGE, 3" HEIGHT, 1/4" THICK  
48" - 31-1248  
52" - 31-1252  
60" - 31-1260  
66" - 31-1266  
72" - 31-1272

**POLY BLADE WEAR BAR**  
60" - 31-2160  
72" - 31-2172  
84" - 31-2184

## SWITCHBLADE - 17-5100

- Kit Contains: (2) 24" Modular Wear Bar (2) 12" Modular Wear Bar (12) Carriage Bolt, Zinc Plated, M8-1.25 x 30mm (12) Flange locknut, Zinc Plated, M8-1.25 (2) Skid Shoe



## V-BAR TIRE CHAINS

- Hardened steel v-bars attached to 4-link 9" cross chains for great penetration and ultimate off-road traction
- Durable steel construction
- "B" size chains fit most ATV/UTV models tire sizes 25 x 8 x 12 - 25 x 8 x 14
- "C" size chains fit most ATV/UTV models tire sizes 26 x 10 x 12 - 26 x 11 x 14
- "D" size chains fit most ATV/UTV models tire sizes 30 x 10 x 14 - 29 x 11 x 14



"B" SIZE CHAINS (PAIR) - 50-0020  
"C" SIZE CHAINS (PAIR) - 50-0030  
"D" SIZE CHAINS (PAIR) - 50-0060

# WINCH & WINCH ACCESSORIES

STANDARDS  
QUICK-MOUNTS  
ATV & UTV MOUNTS

Pull Yourself out of Any Situation!

Kolpin ATV & UTV winches give you the reliability and power to pull your way out of any sticky situation.

5-YEAR  
MECHANICAL  
3-YEAR  
ELECTRICAL  
WARRANTY

WINCH SYSTEMS & ACCESSORIES

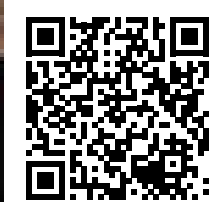



# STANDARD WINCHES

## LOOKING FOR A FULLY-FEATURED ATV OR UTV WINCH? WE'VE GOT THE ANSWER.

- Available in 2500 lb., 3500 lb., 4500 lb. and 6000 lb. models
- Kolpin winches are economical, reliable, high performance and great for plowing and vehicle recovery
- Cable extension available for crew vehicles (85095)

## STANDARD WINCHES

- Center-spool design
- Internal gearing specifically designed for recovery or plowing
- All steel, 3-stage planetary gear train for reliability / smooth operation
- Sealed motor & heavy duty gears can operate fully submerged underwater
- Built to withstand down to -20° F temperatures
- Ergonomic dial for free spool-to-clutch engagement
- Automatic mechanical cable drum brake
- Heavy-duty winch contactor protects ATV/UTV electrical system
- Heavy-duty 6-gauge wiring
- ATV/UTV specific vehicle controls included



Steel

Synthetic

## 5-YEAR MECHANICAL / 3-YEAR ELECTRICAL WARRANTY

WINCH	2500 LBS.	3500 LBS.	4500 LBS.	6000 LBS.
STEEL CABLE	25-9250	25-9350	25-9450	
SYNTHETIC ROPE	25-9255	25-9355	25-9455	25-9605

## WINCH MOUNTS (ATV/UTV)

- Durable winch mount kits provide the necessary hardware to mount Kolpin winches to your vehicle
- Kolpin ATV winch mounts have a 3.0" (76.2mm) x 4.875" (123.83mm) mounting pattern
- Kolpin UTV winch mounts have the wide mounting pattern 3.0" (76.2mm) x 6.60" (167.4mm)
- Made with 7-gauge steel
- Powder coat paint protection



25-XXXX



# QUICK MOUNT WINCHES

## PULL YOURSELF OUT OF ANY SITUATION

- Pre-mounted and pre-wired winch, with leads, solenoid contactor and vehicle specific mount
- Installs on vehicle in 45-minutes
- OEM quick-connect electrical connectors included (where applicable)
- Cable extension available for crew vehicles (85095)

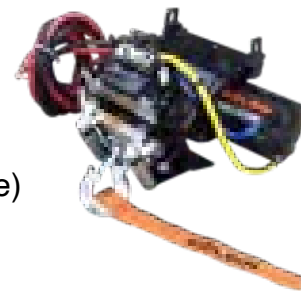

MODEL	YEAR	STEEL 2500 LB.	SYNTH 3500 LB.	SYNTH 4500 LB.
<b>BOBCAT®</b>				
UV34	2019-2025			26-3000 <sup>b</sup>
UV34XL	2019-2025			26-3000 <sup>a, b</sup>
<b>CAN-AM®</b>				
Defender® HD5 (DPS, BASE)	2017-2021			26-7020
Defender® HD7 (DPS, BASE)	2022-2025			26-7020
Defender® HD8 (DPS, XT, BASE)	2016-2021			26-7020
Defender® HD8 (CAB PACKAGE)	2018-2021			26-7020
Defender® HD9 (DPS, XT, BASE)	2022-2025			26-7020
Defender® HD9 (CAB PACKAGE)	2022-2025			26-7020
Defender® HD10 (DPS, XT, BASE)	2016-2018			26-7020
Defender® HD10 (DPS, XT, BASE)	2019-2025			26-7020
Defender® HD10 (CAB PACKAGE)	2018-2025			26-7020
Defender® HD10 XTP	2018-2020			26-7020
Defender® HD10 XMR	2018-2025			26-7020
Defender® MAX HD7 (BASE)	2022-2025			26-7020
Defender® MAX HD8 (DPS, BASE)	2019-2021			26-7020
Defender® MAX HD8 (XT, CAB PACKAGE)	2019-2020			26-7020
Defender® MAX HD9 (DPS, XT, BASE)	2022-2025			26-7020
Defender® MAX HD10 XMR	2019-2025			26-7020
Defender® MAX HD10 (DPS, XT, LONESTAR, CAB PACKAGE)	2019-2025			26-7020
Defender® MAX HD10 / HD8 (CAB PACKAGE, LONESTAR)	2018			26-7020
Defender® MAX HD10 / HD8 (DPS, XT, BASE)	2017-2018			26-7020
Defender® 6X6 HD10 (DPS, XT)	2020-2025			26-7020
Defender® PRO HD10 (DPS, XT)	2020-2025			26-7020
Defender® PRO HD10 (CAB PACKAGE, LONESTAR)	2021-2025			26-7020
<b>HONDA®</b>				
TRX 420 Rancher® (non-AT IRS models)	2014	26-1020	26-1030	
TRX 420 Rancher® (Automatic, IRS (FA5, FA6))	2015-2026	26-1020	26-1030	
TRX 420 Rancher® (Automatic, Straight Axle (FA1, FA2))	2015-2026	26-1020	26-1030	
TRX 420 Rancher® (Manual/Electric Shift, Straight Axle (FM, FE))	2014-2026	26-1020	26-1030	
TRX 500 Rubicon® (IRS Model)	2015-2019	26-1020	26-1030	
TRX 520 Rubicon® (IRS Model)	2020-2026	26-1020	26-1030	
TRX 500 Foreman® (Single Shock, Straight Axle)	2014-2019	26-1020	26-1030	
TRX 520 Foreman® (Single Shock, Straight Axle)	2020-2026	26-1020	26-1030	
Pioneer® 700 / 700-4 (2-Passenger / 4 Passenger)	2014-2025		26-1040	

MODEL	YEAR	STEEL 2500 LB.	SYNTH 3500 LB.	SYNTH 4500 LB.
<b>HONDA® CONT.</b>				
Pioneer® 1000 (3-Passenger)	2016-2025			26-1000
Pioneer® 1000-5 (5-Passenger)	2016-2025			26-1000
Pioneer® 1000-6	2023-2025			26-1000
Talon® 1000 R / X	2019-2025			26-1050
Talon® 1000 RS / XS	2023			26-1050
Talon® 1000R-4 / 1000X-4	2020-2025			26-1050
<b>HAWASAKI®</b>				
Mule Pro - FXT	2015-2023			26-2000
Mule Pro - FXT 820	2025			26-2000
Mule Pro - FXT 1000	2024-2025			26-2000
Mule Pro - DXT	2016-2025			26-2000
Mule Pro - FX	2016-2023			26-2000
Mule Pro - FX 820	2025			26-2000
Mule Pro - FX 1000	2024-2025			26-2000
Mule Pro - DX	2016-2022			26-2000
Mule Pro - FXR	2018-2023			26-2000
Mule Pro - FXR 1000	2024-2025			26-2000
<b>POLARIS</b>				
330 Sportsman ETX	2015	26-3200	26-3210	
400 Hawkeye	2011-2014	26-3200 <sup>a</sup>	26-3210 <sup>a</sup>	
400 Sportsman	2011-2014	26-3200 <sup>a</sup>	26-3210 <sup>a</sup>	
450 Sportsman (All)	2016-2026	26-3200	26-3210	
500 Sportsman (All)	2011-2013	26-3200 <sup>a</sup>	26-3210 <sup>a</sup>	
550 Sportsman (All)	2012-2014	26-3200	26-3210	
570 Sportsman (All)	2014-2026	26-3200	26-3210	
570 Sportsman Touring	2014-2026	26-3200	26-3210	
570 X2 Sportsman	2015-2021	26-3200	26-3210	
570 X2 Sportsman	2025-2026	26-3200	26-3210	
570 Sportsman 6x6	2017-2026	26-3200	26-3210	
800 Sportsman (All)	2012-2014	26-3200 <sup>a</sup>	26-3210 <sup>a</sup>	
800 Sportsman 6x6	2013-2015	26-3200 <sup>a</sup>	26-3210 <sup>a</sup>	
850 Scrambler (All)	2013-2026	26-3200	26-3210	
850 Sportsman (All)	2009-2026	26-3200	26-3210	
850 Sportsman Touring	2015-2026	26-3200	26-3210	
1000 Scrambler (All not 55")	2014-2018	26-3200	26-3210	
1000 XP Sportsman (All not 55")	2015-2026	26-3200	26-3210	
1000 Scrambler S (55")	2020-2026	-	-	-
1000 XP Sportsman S (55")	2020-2026	-	-	-
1000 Sportsman XP Touring	2015-2026	26-3200	26-3210	
Pro XD Full-Size Gas / Crew (Commercial)	2019-2026			26-3000
Pro XD Full-Size Diesel / Crew (Commercial)	2022-2026			26-3000

MODEL	YEAR	STEEL 2500 LB.	SYNTH 3500 LB.	SYNTH 4500 LB.
<b>POLARIS CONT.</b>				
Pro XD Mid-Size / Crew (Commercial)	2022-2026		26-3040	
Pro XD Full-Size Kinetic	2025			26-3000
Ranger EV/LSV (Mid-Size, Round ROPS)	2010-2014		26-3025	
Ranger EV/ETX (Mid-Size, Profile ROPS)	2015-2022		26-3025	
Ranger 400 4x4	2010-2012		26-3025	
Ranger 500 4x4 (Mid-Size, Round ROPS)	2011-2013		26-3025	
Ranger 500 (Mid-Size, Profile ROPS)	2017-2022		26-3025	
Ranger 500 (Mid-Size, Round ROPS)	2026	-	-	-
Ranger 570 (Mid-Size, Profile ROPS)	2015-2021		26-3025	
Ranger Crew 570 (Mid-Size, Profile ROPS)	2015-2021		26-3025 <sup>a</sup>	
Ranger 570 (Mid-Size, Round ROPS)	2014-2016		26-3025	
Ranger 570 (Full-Size, Round ROPS)	2016-2025		26-3025	
Ranger 570 Crew (Full-Size, Round ROPS)	2016-2025		26-3025 <sup>a</sup>	
Ranger 570 SP / Crew (All except base model)	2022-2026		26-3040	
Ranger 570 SP Base / Crew Model (Non-EPS)	2022-2026		26-3040	
Ranger 800 (Mid-Size, Round ROPS)	2013-2015		26-3025	
Ranger 570 XP (Full-Size, Profile ROPS)	2015-2016			26-3000
Ranger 570 XP Crew (Full-Size, Profile ROPS)	2015-2016			26-3000 <sup>a</sup>
Ranger XP 900 (All)	2013-2019			26-3000
Ranger XP 1000 (Profile Tube)	2017			26-3000
Ranger XP 1000 Crew	2017-2018			26-3000 <sup>a</sup>
Ranger 1000 / 1000 Crew (All except base model)	2020-2026			26-3000
Ranger 1000 / 1000 Crew Base model Only (non-EPS)	2020-2026			26-3000 <sup>b</sup>
Ranger XP 1000	2018-2026			26-3000
Ranger XP 1000 Crew	2019-2026			26-3000
Ranger Diesel HST / 1000 Diesel	2015-2018			26-3000
Ranger 1000 Diesel Crew	2015-2018			26-3000 <sup>a</sup>
Ranger XP Kinetic	2023-2024			26-3000
RZR XP 1000 / 4 1000	2024-2025			26-3300
<b>YAMAHA®</b>				
700 Grizzly®	2016-2025	26-5000		
700 Kodiak (All)	2016-2025	26-5000		

<sup>a</sup> Requires Extra Long Battery Connection Cable Kit PN 85095  
<sup>b</sup> Requires Front Bumper / Roller Mount Kit PN 35-3050

## SYNTHETIC WINCH ROPES

- 12ft, 1/4" diameter rope. *For plow lifting (85075)*
- 39ft, 1/4" diameter rope. *To replace factory rope/cable on Kolpin 4500 lb winches (85064)*
- 50ft, 3/16" diameter rope. *To replace factory rope/cable on Kolpin 2500 lb & 3500 lb winches (85065)*
- 50ft, 7/64" diameter rope. *To replace factory rope/cable on Kolpin 6000 lb winches (85059)*



**12FT - MAX WEIGHT CAP. 5500 LBS - 85075**

**39FT - MAX WEIGHT CAP. 5500 LBS - 85064**

**50FT - MAX WEIGHT CAP. 4000 LBS - 85065**

**50FT - MAX WEIGHT CAP. 7000 LBS - 85059**

## PLOW LIFT STRAP

- Durable strap designed to replace winch rope and minimize breakage due to repetitive plow lifting cycles
- Wide nylon webbing design reduces binding & kinking associated with synthetic ropes & steel cables
- Reduces wear and tear on hawse and roller fairleads
- Compatible with any winch with rope size up to 1/4" diameter



**85092**

## WIRELESS WINCH REMOTE

- Water-resistant, wireless winch remote provides cord-free winch control
- 50-ft. Range
- On/Off, In/Out buttons and Power Indicator
- Mountable storage holster included
- Receiver works with virtually any ATV/UTV winch
- Includes all mounting hardware & installs in 20-minutes



**25-0500**

## BOLT-ON RUBBER WINCH STOP

- Two-piece design installs easily around winch cable or rope
- For use with steel cables or synthetic ropes up to 1/2" diameter
- Increases the life of cables, synthetic ropes and fairleads



**85080 - SINGLE**

**85086 - ORDER IN MULTIPLES OF 18**

## AUTO-STOP KITS

- Works to automatically stop winch at end of rope pull or plow lift
- Integrated Aluminum Hawse Fairlead
- Requires synthetic winch rope - sold separately (not compatible with steel cable)
- Installs easily in place of stock fairlead
- All mounting hardware included



**25-0600 - ATV - 4.875" MTG HOLE**

**25-0650 - UTV - 6" MTG HOLE**

## ATV/UTV SNATCH BLOCK PULLEY

- 4-Ton Max Weight Limit
- Increase your pulling power for use with up to 5/16" diameter winch ropes or steel cables
- All steel construction for extra strength & long life



**25-0400**

## WINCH ELECTRIC CONTACTOR

- Compatible with Kolpin Winch Kits, Rocker Switches and Corded Hand Held Switch
- Protects your ATV/UTV electrical system and switches the power distribution of your winch that is controlled by your switches



**85068**

## ATV STANDARD ROLLER FAIRLEAD

- Designed to reduce cable wear, especially on sharp angle pulls
- Compatible with Kolpin Winch Kits
- Bolt pattern is standard 4.875"
- Works with synthetic rope and steel cables



STEEL - 85069

## UTV WIDE ROLLER FAIRLEAD

- Designed to reduce cable wear, especially on sharp angle pulls
- Compatible with Kolpin Winch Kits
- Bolt pattern is 6"
- Works with synthetic rope and steel cables



STEEL - 85087

## FORGED STEEL WINCH HOOK

- Heavy-Duty Zinc Plated Steel
- Clevis pin included
- Compatible with most winches



RPR0108

## POLARIS ATV HANDLEBAR WINCH SWITCH

- Compatible with Polaris ATV Quick-Mount Winch Kits 26-3100, 26-3110, 26-3200 and 26-3210
- Includes handlebar switch, handlebar clamp and customer wiring harness to specifically plug into the Polaris ATV vehicle handlebar harness



85096

## CORDED HAND HELD SWITCH

- Compatible with Kolpin Winch Kits & Rocker Switches
- Control your winch from a distance
- Includes socket plug and 11' 4" length of corded wiring



85067

## UTV DASH ROCKER SWITCH KIT

- Mountable to UTV dashboard, allows winch control from cab of UTV
- Quick-connect plug for hassle-free installation
- Snap-in installation requires standard UTV mounting hole



25-0700

## ATV MINI ROCKER SWITCH

- Compatible with Kolpin winch kits
- Control your winch with just the touch of your finger while your hands are on the handlebar
- Includes 7/8" diameter handlebar clamp, mounting bracket and hardware



85066

## BATTERY CONNECTION CABLES

- Heavy-duty 6-gauge connection cables rated to 600 volts
- Color-coded ring terminal end for easy installation
- Compatible with Kolpin winch kits

SHORT 36" (PAIR) - 85089

LONG 96" (PAIR) - 85090

EXTRA LONG 144" (PAIR) - 85095



85089

## STEEL CABLE

- Compatible with all Kolpin winches
- 3/16" diameter x 50' length (2500lb)
- 7/32" diameter x 50' length (3500/4500lb)
- Super-duty galvanized aircraft cable
- Heavy-duty thimble cable loop on hook end



2500 LB - 85062

3500/4500 LB - 85063

# CAB COMPONENTS

DOORS  
ROOFS  
WINDSHIELDS

Outfit your UTV / Side x Side

Durable, heavy-duty aftermarket doors, windshields and roofs to protect you, your passengers and your cargo from the elements.

KEEP  
YOURSELF  
DRY &  
PROTECTED

CAB COMPONENTS

DOORS



ROOFS

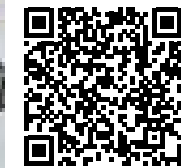

WINDSHIELDS



## POLARIS RANGER 1000 / XP 1000 FRONT HALF DOORS

- 30 minute installation with 8 fasteners per door (sold as a pair); doors are fully assembled
- Reliable multi-point mounting system with easy on, easy off e-clip & hinge pin removal
- Standard automotive forward opening (like your truck); limit stop built into hinge design to control door opening
- Premium aluminum door handle with automotive-style latch (doesn't rattle) and kick panel accents
- OEM-matching design with ergonomic top edge provides a comfortable ride
- Thick D-Trim seals around lower edge for splash-free riding
- Easily add-on optional soft upper doors for complete cab enclosure
- Optional door bags attach easily to built-in mounting points (sold separately)



32000

## POLARIS RANGER 1000 / XP 1000 FRONT UPPER SOFT DOORS

- Quick on/off 15 minute installation with four screws per door (sold as a pair)
- Durable steel framing with weather-resistant nylon canvas
- -20°F cold-crack-rated PVC windows with double zippered full opening
- Clean door handle access with zippered closure
- Thick trim seals around upper edge for complete cab enclosure
- \*Requires Front Door installation (32000)



32500

## POLARIS RANGER 1000 / XP 1000 CREW REAR HALF DOORS

- 30 minute installation with 8 fasteners per door (sold as a pair); doors are fully assembled
- Reliable multi-point mounting system with easy on, easy off e-clip & hinge pin removal
- Standard automotive forward opening (like your truck); limit stop built into hinge design to control door opening
- Premium aluminum door handle with automotive-style latch (doesn't rattle) & kick panel accents
- OEM-matching design with ergonomic top edge provides a comfortable ride



32010

## POLARIS RANGER 1000 / XP 1000 REAR UPPER SOFT DOORS

- Quick on/off 15 minute installation with four screws per door (sold as a pair)
- Durable steel framing with weather-resistant nylon canvas
- 20°F cold-crack-rated PVC windows with double zippered full opening
- \*Requires Rear Half Door installation (32010)



32510

## POLARIS RANGER 1000 / XP 1000 FRONT DOOR BAGS

- Made of durable, long-lasting materials and designed to fit Ranger 32000 Front Half Doors
- Add convenient storage and interior comfort to your 32000 Ranger Half Doors
- Easy to attach and remove from front doors
- Set of 2 — left and right front door bags
- Two-compartment design
- Lockable zippered pockets



32005

## POLARIS RANGER 570 FRONT HALF DOORS



- 30-minute installation with 9 fasteners per door (sold as a pair); doors are fully assembled
- Reliable multi-point mounting system with easy on, easy off e-clip & hinge pin removal
- Standard automotive forward opening (like your truck); limit stop built into hinge design to control door opening
- Premium aluminum door handle with automotive-style latch (doesn't rattle) and kick panel accents
- OEM-matching design with ergonomic top edge provides a comfortable ride
- Thick D-Trim seals around lower edge for splash-free riding
- Easily add-on optional soft upper doors for complete cab enclosure
- Optional upper soft doors (32600)



## POLARIS RANGER 570 REAR HALF DOORS



- 30-minute installation with 9 fasteners per door (sold as a pair); doors are fully assembled
- Reliable multi-point mounting system with easy on, easy off e-clip & hinge pin removal
- Standard automotive forward opening (like your truck); limit stop built into hinge design to control door opening
- Premium aluminum door handle with automotive-style latch (doesn't rattle) & kick panel accents
- OEM-matching design with ergonomic top edge provides a comfortable ride
- Thick D-Trim seals around the lower edge for splash-free riding
- Easily add-on optional soft upper doors for a complete cab enclosure
- Optional upper soft doors (32610)



32100

## POLARIS RANGER 570 FRONT UPPER SOFT DOORS



- Quick on/off 15 minute installation with four screws per door (sold as a pair)
- Durable steel framing with weather-resistant nylon canvas
- -20°F cold-crack-rated PVC windows with double zippered full opening
- Clean door handle access with zippered closure
- Thick trim seals around upper edge for complete cab enclosure
- \*Requires Front Door installation (32100)



32110

## POLARIS RANGER 570 REAR UPPER SOFT DOORS



- Quick on/off 15-minute installation with four screws per door (sold as a pair)
- Durable steel framing with weather-resistant nylon canvas
- -20°F cold-crack-rated PVC windows with double zippered full opening
- Clean door handle access with zippered closure
- Thick trim seals around the upper edge for a complete cab enclosure
- Requires 32110 Rear Door installation



32600

32610



**THERMOFORMED ROOFS**

- UV-Stabilized super durable HWPE (High-Molecular Weight Polyethylene)
- Robotically trimmed and drilled for precision fitment
- Compatible with Kolpin Windshields & Back Panels



SEE PAGE 150-167 FOR FITMENT CHART

**POLARIS YOUTH COMBO KITS**

- Provides extra protection for the Youth RZR 170, Youth RZR 200 and Youth Ranger 150
- Includes Poly Roof, Poly Front Windshield & Poly Rear Windshield
- Windshields are constructed of 1/8" abrasive-resistant polycarbonate
- Easy installation with included hardware
- Ranger 150 (2150) has improved mounting strength with 1 1/2" diameter steel clamps with vinyl coating



**POLY ROOFS**

**LIGHTWEIGHT SUN & RAIN PROTECTION**

Restyled, strong, lightweight, and dependable. Keep out the sun, rain and snow! We offer a full lineup of roofs for today's most popular UTVs.

SEE PAGE 150-167 FOR FITMENT CHART

- RZR 170 - 2100
- RZR 200 - 2110
- RANGER 150 - 2150\*



## METAL ROOFS

- Heavy-duty 14-gauge thick steel panel construction or 10-gauge aluminum panel construction
- Integrated visor for protection and accessory mounting
- Includes rubber seals for placement in-between roll cage and roof to minimize noise and wear
- Quick and easy install in less than 30 minutes
- Compatible with Kolpin glass windshields and select back panels
- Stiffening ribs added to the construction of some models

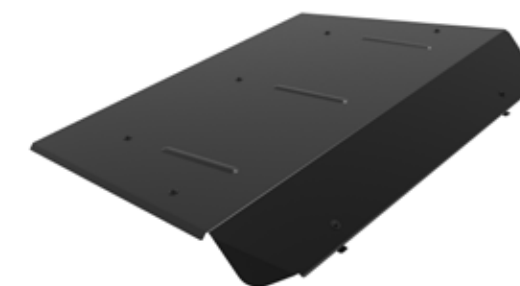
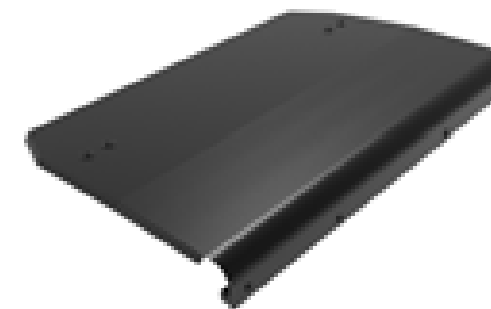

SEE PAGE 150-167 FOR FITMENT CHART

## ROOF FOAM LINER INSULATION

- 5mm adhesive-backed foam pad to stick to underside of metal roofs
- Reduces noise, squeaks, cushions roof against frame
- Enhances appearance with a premium look and soft-touch surface



# METAL ROOFS

## WE'VE GOT YOU COVERED

Durable, strong, metal roofs to protect you and your passengers from the elements and fit tightly on your UTV roll cage. We've got a lineup of metal roofs for today's most popular UTVs.

SEE PAGE 150-167 FOR FITMENT CHART

STANDARD - 29005  
 RANGER XP - 29010  
 RANGER XP CREW - 29020



# UTV WINDSHIELDS

## A CLEAR VIEW OF THE ADVENTURE AHEAD

Customize your UTV's cab with the Poly Windshield that's right for your journey. We have a wide variety of Poly Shield options in half, full, rear and tilting styles for today's most popular UTVs.

SEE PAGE 150-167 FOR FITMENT CHART

## WINDSHIELD STYLES

### HALF-FIXED

- Lip on upper shield deflects air over operator and passenger
- Easy to install and no drilling required
- Scratch-resistant finish
- Extremely durable - injection molded c-clamps
- Trailerable
- Average height is 9 to 9 1/2"



### FULL-FIXED

- Custom design for each vehicle model
- Easy to install and no drilling required
- Extremely durable - injection molded c-clamps
- Trailerable
- Compatible with roofs
- Scratch-resistant finish



### VENTED FULL-FIXED

- Custom design for each vehicle model
- Easy, tool-less vent adjustment from fully closed to fully open, with "stop" positions at closed, defrost mode, and open
- Scratch-resistant finish
- Easy to install - NO drilling required
- Pre-cut holes for (2) Vents
- Trailerable



### FULL-TILT

- Versatile three-position tilt
- Opens 3" or 5 1/2"
- Easy to install and no drilling required
- Removable without tools
- Extremely durable - injection molded c-clamps
- Trailerable in closed and locked position
- Scratch-resistant finish



### REAR

- Provides barrier to keep debris from swirling into the cab
- Easy to install and no drilling required
- Extremely durable - injection molded c-clamps
- Compatible with most roofs





# GLASS WINDSHIELDS

## HEAVY-DUTY PROTECTION & A CLEAR VIEW.

Heavy-duty, steel-framed, DOT-approved glass windshields offer maximum durability and visibility.

Customize today's most popular UTV models with these premium shields, featuring (2) sliding air vents and compatibility with wiper kits (sold separately).

SEE PAGE 150-167 FOR FITMENT CHART

## GLASS WINDSHIELDS

- Fits with most OEM & Kolpin roofs
- Designed and pre-drilled to accommodate wiper kits (sold separately)
- High-quality, scratch-resistant, DOT-approved, laminated safety glass
- Durable, powder-coated, 14-gauge steel frame, with e-coat primer for long-lasting durability
- Wraps around and mounts securely to A-Pillars to create a no-gap seal
- Dual sliding vents increase in-cab airflow
- Model-specific design with rubber gasket for seamless vehicle integration
- Installs in 15 minutes



SEE PAGE 150-167 FOR FITMENT CHART

28200

## MANUAL WIPER KIT

- Easy, hand-operated, durable UTV wipers
- Quick installation with most Kolpin glass windshields
- Quick & easy install to poly windshields (Kolpin and other brands) with drilling of one hole



28000



28005

**13" STEEL ARM WITH 12" RUBBER BLADE**  
28000

**10" STEEL ARM WITH 10" RUBBER BLADE**  
28005

**10" STEEL ARM WITH 10" & 12" RUBBER BLADE - 28010**



28010

ATV MODEL	YEAR	RECEIVER HITCH	SUSPENSION LOCK	STORM CHASER / HIGH RISE PLOW		SWITCHBLADE PLOW FITMENT	QUICK-MOUNT WINCH HIT		ATV WINCH MOUNT
				VEHICLE MOUNT	MOUNT		STEEL 2500 LB	SYNTHETIC 3500 LB	
<b>ARCTIC CAT® / TEXTRON®</b>				<b>ARCTIC CAT® / TEXTRON®</b>					
All IRS Models	ALL	OEM 2"	85200						
250 2x4	2006-2007				15-5531	15-0050	17-0000		
400i 4x4 (With IRS)	2002-2004	OEM 2"	85200				17-0000		
400 4x4 TRV	2005-2015	OEM 2"	85200		15-6550	15-0050	17-0000		
400 4x4	2005-2014	OEM 2"	85200						OEM Equipped
450i 4x4	2010-2012	OEM 2"	85200		15-6550	15-0050	17-0000		OEM Equipped
500 4x4	2002-2004						17-0000		
500 4x4 (non-XR and non-Alterra®)	2005-08, 2013-17	OEM 2"	85200		15-6550	15-0050	17-0000		OEM Equipped
550 4x4 (non-XR and non-Alterra®)	2009-2015	OEM 2"	85200		15-6550	15-0050	17-0000		OEM Equipped
650 4x4	2004	OEM 2"	85200				17-0000		
650 4x4	2005-2010	OEM 2"	85200		15-6550	15-0050	17-0000		OEM Equipped
700 4x4 (non-XR and non-Alterra®)	2006-2017	OEM 2"	85200		15-6550	15-0050	17-0000		OEM Equipped
700 4x4 Diesel	2007-2010	OEM 2"	85200		15-6550	15-0050	17-0000		OEM Equipped
700 4x4 Diesel	2011-2012	OEM 2"	85200						OEM Equipped
1000 4x4 TRV	2008-2017	OEM 2"	85200		15-6550	15-0050	17-0000		OEM Equipped
XR 500 / XR 550 / XR 550 XT / XR 700 / XR 700 XT	2015	OEM 2"	85200		15-6580	15-0050	17-0000		
Alterra® 450	2016-2022					15-0050	17-0000		
Alterra® 600	2022-2024					15-0050	17-0000		
Alterra® 600 TRV	2023-2024					15-0050			
Alterra® 500 XT / 550 / 550 XT	2016				15-6580	15-0050	17-0000		
Alterra® 570 / 570 XT	2019-2021	OEM 2"	85200		15-6580	15-0050	17-0000		
Alterra® 700 / 700 XT	2016-2021	OEM 2"	85200		15-6580	15-0050	17-0000		
VLX 700 / TBX 700	2018-2019	OEM 2"			15-6550	15-0050	17-0000		
<b>ARGO</b>				<b>ARGO</b>					
Xplorer XR 500 (BASE, SE, EPS, LE)	2018-2024	OEM 2"	85200		15-1521	15-0050			
Xplorer XR 570 (BASE/LE)	2021-2022					15-0050			
Xplorer XR 700 (EPS/LE)	2022-2024	OEM 2"	85200			15-0050			
Xplorer XRT 570 (BASE, LE)	2022-2023	OEM 2"	85200			15-0050			
Xplorer XRT 600 (EPS, LE)	2024					15-0050			
Xplorer XRT 1000 (LE)	2018-2024	OEM 2"	85200			15-0050			
Magnum XF 500	2022-2023	OEM 2"							
<b>CAN-AM®</b>				<b>CAN-AM®</b>					
330 Outlander	2004-2005						17-0000		
400 Outlander	2003-2014				15-7561		17-0000		
450 / 500 / 570 Outlander L	2015-2016				15-7580		17-0000		OEM Equipped
450 / 450 Max / 570 Outlander	2017-2023				15-7590		17-0000		OEM Equipped
450 Outlander 6x6 MAX	2019-2025				15-7590		17-0000		OEM Equipped
500 Quest	2003				15-7511	15-0050	17-0000		OEM Equipped
500 Traxter	1999-2005				15-7511	15-0050	17-0000		
500 Outlander	2007-2012				15-7561		17-0000		

ATV MODEL	YEAR	RECEIVER HITCH	SUSPENSION LOCK	STORM CHASER / HIGH RISE PLOW		SWITCHBLADE PLOW FITMENT	QUICK-MOUNT WINCH HIT		ATV WINCH MOUNT
				VEHICLE MOUNT	MOUNT		STEEL 2500 LB	SYNTHETIC 3500 LB	
<b>CAN-AM® CONT</b>				<b>CAN-AM® CONT</b>					
500 Outlander	2013-2014	OEM 2"		15-7590		17-0000			OEM Equipped
500 Outlander / Outlander MAX (Base/DPS/L)	2023-2025			15-7600	15-0050				
570 Outlander	2017-2023			15-7590					
570 Outlander MAX / XMR	2016-2023			15-7590		17-0000			OEM Equipped
650 Quest	2002-2004			15-7511	15-0050	17-0000			OEM Equipped
650 Traxter	2005			15-7511	15-0050	17-0000			
650 Outlander	2006-2012			15-7561		17-0000			
650 Outlander / 650 MAX / XMR	2013-2022	OEM 2"		15-7590		17-0000			OEM Equipped
650 Outlander 6x6	2015-2020			15-7590		17-0000			OEM Equipped
650 Outlander 6x6 MAX	2019-2025			15-7590		17-0000			OEM Equipped
700 Outlander / Outlander MAX	2023-2025			15-7600	15-0050				OEM Equipped
800 Outlander	2006-2009			15-7561		17-0000			
800 Outlander	2012-2015			15-7590		17-0000			OEM Equipped
800 Outlander MAX	2006-2012			15-7561		17-0000			
800 Outlander MAX	2013-2015			15-7590		17-0000			OEM Equipped
800 Outlander XMR	2012			15-7561		17-0000			
800 Outlander XMR	2015			15-7590					OEM Equipped
800R / 800R MAX Outlander	2010-2011			15-7561		17-0000			
800R / 850 Outlander	2012-2022	OEM 2"		15-7580		17-0000			OEM Equipped
850 / 850 MAX / 850 XMR Outlander	2016-2024			15-7590					OEM Equipped
850 Outlander (Base, DPS, XMR, XT)	2025			15-7600	15-0050				OEM Equipped
1000 Outlander	2012-2019	OEM 2"		15-7590		17-0000			OEM Equipped
1000 Outlander 6x6	2014-2019			15-7590		17-0000			OEM Equipped
1000 Outlander MAX	2013-2019			15-7590		17-0000			OEM Equipped
1000 Outlander XMR	2013-2024			15-7590		17-0000			OEM Equipped
1000 Outlander 6x6 MAX	2019-2025			15-7590		17-0000			OEM Equipped
1000R / 1000R MAX Outlander	2019-2024			15-7590		17-0000			OEM Equipped
1000R / 1000R MAX Outlander	2025			15-7600					OEM Equipped
Outlander Pro HD5 / XU HD5 / HD7 / XU HD7	2023-2025			15-7600	15-0050				OEM Equipped
500 Renegade®	2008-2012			15-7561		17-0000			
500 Renegade®	2013-2015			15-7590		17-0000			
570 Renegade®	2016-2022			15-7590		17-0000			
570 Renegade® XMR	2017-2021			15-7590		17-0000			
650 Renegade®	2018-2019			15-7590		17-0000			
650 Renegade®	2023-2025			15-7590		17-0000			
650 Renegade® XMR	2022-2024			15-7590		17-0000			
800 Renegade®	2007-2011			15-7561		17-0000			
800 Renegade®	2012-2015			15-7590		17-0000			
800 Renegade® X	2008-2011			15-7561		17-0000			
850 Renegade®	2016-2022			15-7590		17-0000			
850 Renegade® XMR	2017-2019			15-7590		17-0000			

				STORM CHASER / HIGH RISE PLOW		SWITCHBLADE PLOW FITMENT	QUICK-MOUNT WINCH HIT		ATV WINCH MOUNT
ATV MODEL	YEAR	RECEIVER HITCH	SUSPENSION LOCK	VEHICLE MOUNT	MOUNT		STEEL 2500 LB	SYNTHETIC 3500 LB	
<b>CAN-AM® CONT</b>				<b>CAN-AM® CONT</b>					
850 Renegade® X XC	2020-2022			15-7590		17-0000			
1000 Renegade®	2012-2019			15-7590		17-0000			
1000R Renegade®	2018-2019			15-7590		17-0000			
1000 Renegade® XMR	2017-2024			15-7590					
1000 Renegade® X XC	2020-2025			15-7590					
<b>CF MOTO®</b>				<b>CF MOTO®</b>					
X5	2009				15-0050				
X5 / X6 / X8	2012-2014			15-9000	15-0050				
CFORCE® 400	2016-2020	85100	85200	15-9000	15-0050				
CFORCE® HO 2-UP (CA)	2022-2024			15-9000	15-0050				
CFORCE® 400 (not S model)	2016-2018	85100	85200	15-9000	15-0050	17-0000			
CFORCE® (Gen 2)	2022-2025			15-9000	15-0050				
CFORCE® 400 S	2019-2020	85100	85200	15-9000	15-0050	17-0000			
CFORCE® 500	2013-2020	OEM 2"	85200	15-9000	15-0050	17-0000			
CFORCE® 500 (not S model)	2013-2018	OEM 2"	85200	15-9000	15-0050	17-0000			
CFORCE® 500 S	2017-2021	OEM 2"	85200	15-9000	15-0050	17-0000			
CFORCE® 500 (Gen 2)	2022-2025			15-9000	15-0050				
CFORCE® 600	2013-2014	OEM 2"	85200	15-9000	15-0050				
CFORCE® 600 (not Touring model)	2019-2025	OEM 2"	85200	15-9020	15-0050	17-0000			
CFORCE® 600 Touring	2020-2025	OEM 2"	85200	15-9020	15-0050	17-0000			
CFORCE® 800 (not XC model)	2013-2020	OEM 2"	85200	15-9000	15-0050	17-0000			
CFORCE® 800 XC	2019-2024	OEM 2"	85200	15-9010	15-0050	17-0000			
CFORCE® 800 Touring (Gen 3)	2024-2025			15-9030					
CFORCE® 1000 Overland (Gen 2)	2021-2024			15-9010					
CFORCE® 1000 Overland (Gen 3)	2025			15-9030					
CFORCE® 1000 Touring (Gen 3)	2024-2025			15-9030					
<b>HONDA®</b>				<b>HONDA®</b>					
TRX 250 Recon	1998-2025			15-1521	15-0050	17-0000			
TRX 300 Fourtrax®	1993-2000			15-1510		17-0000			25-1042
TRX 350 Rancher®	2000-2003	85135		15-1550		17-0000			25-1080
TRX 350 Rancher®	2004-2006	85135		15-1591	15-0050	17-0000			25-1081
TRX 400 Foreman®	1995-2003			15-1580		17-0000			25-1061
TRX 400 Rancher®	2004-2007			15-1591	15-0050	17-0000			25-1081
TRX 420 Rancher® (All)	2007-2013	85135		15-1620	15-0050	17-0000			25-1210
TRX 420 Rancher® (AT IRS models)	2009-2014	85130		15-1620	15-0050	17-0000			25-1210
TRX 420 Rancher® (Automatic, IRS (FA5, FA6))	2015-2026	85130		15-1630	15-0050	17-0000	26-1020	26-1030	25-1270
TRX 420 Rancher® (non-AT IRS models)	2014	85130		15-1630	15-0050	17-0000	26-1020	26-1030	25-1270
TRX 420 Rancher® (Automatic, Straight Axle (FA1, FA2))	2015-2026	85135		15-1630	15-0050	17-0000	26-1020	26-1030	25-1270
TRX 420 Rancher® (Man Shift/Elect. Shift, S.A. (FM, FE))	2014-2026	85135		15-1630	15-0050	17-0000	26-1020	26-1030	25-1270
TRX 450 Foreman®	1998-2004	85135		15-1560		17-0000			25-1061

ATV MODEL	YEAR	RECEIVER HITCH	SUSPENSION LOCK	STORM CHASER / HIGH RISE PLOW		SWITCHBLADE PLOW FITMENT	QUICK-MOUNT WINCH HIT		ATV WINCH MOUNT
				VEHICLE MOUNT	MOUNT		STEEL 2500 LB	SYNTHETIC 3500 LB	
<b>HONDA® CONT.</b>				<b>HONDA® CONT.</b>					
TRX 500 Foreman®	2005-2006	85135		15-1600	15-0050	17-0000			
TRX 500 Foreman®	2007-2011	85135		15-1600	15-0050	17-0000			25-1200
TRX 500 Foreman®	2012-2013	85135			15-0050	17-0000			25-1220
TRX 500 Rubicon®	2001-2004	85135		15-1560		17-0000			25-1090
TRX 500 Rubicon®	2005-2006	85135		15-1600	15-0050	17-0000			25-1161
TRX 500 Rubicon®	2007-2014	85135		15-1600	15-0050	17-0000			25-1200
TRX 500 (Single Shock, Straight Axle)	2014-2019	85135		15-1630	15-0050	17-0000	26-1020	26-1030	25-1270
TRX 500 / 520 Rubicon® (IRS models)	2015-2026	85130	85200	15-1630	15-0050	17-0000	26-1020	26-1030	25-1270
TRX 520 Foreman® (Single Shock, Straight Axle)	2020-2026	85135		15-1630	15-0050	17-0000	26-1020	26-1030	25-1270
TRX 650 / 680 Rincon®	2003-2023	85130	85200	15-1570	15-0050	17-0000			25-1190
TRX 700 Rubicon®	2024-2025	85130	85200	15-1570	15-0050	17-0000			
<b>HAWASAKI®</b>				<b>HAWASAKI®</b>					
300 Brute Force®	2012-2025				15-0050	17-0000			OEM Equipped
360 Prairie	2002-2005	85160			15-0050	17-0000			25-2150
360 Prairie	2006-2013	85160			15-0050	17-0000			25-2290
450 Brute Force®	2025	OEM 2"	85200		15-0050	17-0000			
650 Brute Force® 4x4	2005-2013	85160		15-2570	15-0050	17-0000			25-2310
650 Brute Force® 4x4i (IRS Model)	2006-2013	85100	85200	15-2610	15-0050	17-0000			25-2310
650 Prairie 4x4	2002-2003	85160		15-2570	15-0050	17-0000			25-2131
700 Prairie 4x4	2004-2006	85160		15-2570	15-0050	17-0000			25-2131
750 Brute Force® 4x4i	2005-2025	85100	85200	15-2610	15-0050	17-0000			25-2310
<b>POLARIS</b>				<b>POLARIS</b>					
ACE / ACE 570 / ACE 900	2014-2019	OEM 1.25"			15-0050	17-0000			25-3410
250 4x4 & 4x6	1989-2001			15-3520		17-0000			
Hawkeye 2x4 / 4x4	2006-2011				15-0050	17-0000			
300 Xplorer 4x4	1997-1998								25-3043
300 Sportsman	2008-2010				15-0050	17-0000			25-3280
325 Magnum	2000-2002								25-3043
330 Magnum & ATP	2003-2005			15-3591		17-0000			25-3043
330 Sportsman ETX	2015		85200	15-3591		17-0000	26-3200	26-3210	25-3410
335 Sportsman	1999-2000	85100	85200	15-3550		17-0000			25-3043
350 2x4 / 4x4 / 6x6	1989-1993			15-3520		17-0000			
400 2x4 / 4x4	1994-1997			15-3520		17-0000			
400 Sportsman	2001			15-3550		17-0000			25-3043
400 Sportsman	2002-2005			15-3591		17-0000			25-3043
400 Sportsman	2004-2004.5			15-3591					25-3190*
400 Sportsman H.O.	2008-2010				15-0050	17-0000			25-3280
400 Sportsman H.O.	2011-2014	85100	85200	15-3591		17-0000	26-3200 <sub>a</sub>	26-3210 <sub>a</sub>	25-3410
400 Xplorer 4x4	1995-2001								25-3043
400 Hawkeye	2011-2014		85200	15-3591			26-3200 <sub>a</sub>	26-3210 <sub>a</sub>	25-3410

ATV MODEL	YEAR	RECEIVER HITCH	SUSPENSION LOCK	STORM CHASER / HIGH RISE PLOW		SWITCHBLADE PLOW FITMENT	QUICK-MOUNT WINCH HIT		ATV WINCH MOUNT
				VEHICLE MOUNT	MOUNT		STEEL 2500 LB	SYNTHETIC 3500 LB	
<b>POLARIS CONT.</b>				<b>POLARIS CONT.</b>					
425 Magnum 4x4 / 4x6	1995-1998				15-3520		17-0000		
425 Xpedition 4x4	2000-2002								25-3043
445 Diesel	1999				15-3550		17-0000		25-3043
450 Sportsman	2006-2007	85100	85200		15-3591		17-0000		25-3260
450 Sportsman (ALL)	2016-2026		85200		15-3591		17-0000	26-3200	26-3210
500 Magnum	1999-2002								25-3043
500 Sportsman H.O. & EFI	2003				15-3591		17-0000		25-3043
500 Sportsman H.O. & EFI	2005-2010		85200		15-3591		17-0000		25-3260
500 Sportsman H.O & EFI (ALL)	2005-2013	85100	85200		15-3591		17-0000		
500 X2 Sportsman	2006-2010	85100	85200						25-3260
500 Sportsman	2004-2004.5				15-3591				25-3190*
500 Sportsman (ALL)	2011-2013	85195	85200		15-3591			26-3200 <sub>a</sub>	26-3210 <sub>a</sub>
550 Sportsman (ALL)	2012-2014	85195	85200		15-3670	15-0050	17-0000	26-3200	26-3210
570 Sportsman 6x6	2000-2003								25-3043
570 Sportsman 6x6	2017-2024	OEM 2"	85200		15-3591		17-0000	26-3200	26-3210
570 Sportsman 6x6	2025-2026	OEM 2"	85200				17-0000	26-3200	26-3210
570 Sportsman (ALL)	2014-2026		85200		15-3591		17-0000	26-3200	26-3210
570 Sportsman Touring	2014-2024		85200		15-3591		17-0000	26-3200	26-3210
570 Sportsman Touring	2025-2026						17-0000	26-3200	26-3210
570 Sportsman X2	2015-2021		85200		15-3591		17-0000	26-3200	26-3210
570 Sportsman X2	2025-2026							26-3200	26-3210
600 Sportsman	2003-2004				15-3591		17-0000		
600 Sportsman	2004-2004.5								25-3190*
600 Sportsman	2005-2006	85100	85200						
700 Sportsman	2004-2004.5				15-3591				25-3190*
700 Sportsman	2005-2007	85100	85200		15-3591		17-0000		25-3260
700 X2 Sportsman	2008	85100	85200		15-3591				25-3260
800 Sportsman	2005-2010	85100	85200		15-3591		17-0000		25-3260
800 Sportsman (Excluding 6x6)	2011-2014	85100	85200		15-3591		17-0000		
800 Sportsman 6x6	2013-2015						17-0000	26-3200 <sub>a</sub>	26-3210 <sub>a</sub>
800 X2 Sportsman	2007-2009	85100	85200						25-3260
800 Sportsman (ALL)	2011-2014	85195	85200		15-3670	15-0050	17-0000	26-3200 <sub>a</sub>	26-3210 <sub>a</sub>
850 Scrambler (ALL)	2013-2026	85195	85200		15-3670	15-0050	17-0000	26-3200	26-3210
850 Sportsman (ALL)	2009-2026	85195	85200		15-3670	15-0050	17-0000	26-3200	26-3210
850 Sportsman Touring	2015-2026	85195	85200		15-3670	15-0050	17-0000	26-3200	26-3210
1000 Scrambler (ALL)	2014-2019	85195	85200		15-3670	15-0050	17-0000	26-3200	26-3210
1000 Scrambler S (55")	2020-2026					15-0050	17-0000		
1000 Scrambler (All not 55")	2014-2018				15-3670	15-0050	17-0000	26-3200	26-3210
1000 XP Sportsman (ALL not 55")	2015-2026	85195	85200		15-3670	15-0050	17-0000	26-3200	26-3210
1000 XP Sportsman S (55")	2020-2026					15-0050	17-0000		
1000 XP Sportsman Touring	2015-2026	85195	85200		15-3670	15-0050	17-0000	26-3200	26-3210

ATV MODEL	YEAR	RECEIVER HITCH	SUSPENSION LOCK	STORM CHASER / HIGH RISE PLOW		SWITCHBLADE PLOW FITMENT	QUICK-MOUNT WINCH HIT		ATV WINCH MOUNT
				SUZUKI®	MOUNT		STEEL 2500 LB	SYNTHETIC 3500 LB	
<b>SUZUKI®</b>				<b>SUZUKI® CONT.</b>					
250 2x4	1997-2001					17-0000			
280 King Quad®	98 & Older					17-0000			
300 King Quad®	1999-2002					17-0000			
400 Eiger	2002-2004	85180			15-4550	17-0000			
400 Eiger	2005-2007	85180			15-4581	15-0050	17-0000		
400 King Quad® (ALL)	2008-2025	85180			15-4581	15-0050	17-0000		25-4210
450 King Quad®	2007-2010	85100	85200		15-4590	15-0050	17-0000		25-4100*
500 King Quad® (ALL)	2009-2025	85100	85200		15-4590	15-0050	17-0000		25-4100
500 Quad Runner	02 & Older				15-4550	17-0000			
500 Vinson	2002-2007	85180			15-4550	17-0000			
700 Twin Peak	2004-2005	85160			15-2570	15-0050	17-0000		25-2131
700 King Quad®	2005-2007	85100	85200		15-4590	15-0050	17-0000		25-4100*
750 King Quad® (ALL)	2008-2025	85100	85200		15-4590	15-0050	17-0000		25-4100*
<b>TEXTRON®</b>				<b>TEXTRON®</b>					
Alterra® 300 / 500	ALL	OEM 2"	85200						
<b>TRACKER</b>				<b>TRACKER</b>					
300	2020-2021				15-5531	15-0050			
450	2020-2024					15-0050			
570 / 700	2020-2021				15-6580	15-0050			
600	2022-2024					15-0050			
<b>YAMAHA®</b>				<b>YAMAHA®</b>					
350 Bruin	2004-2006				15-5590	15-0050	17-0000		
350 Grizzly® (IRS models)	2007-2011	85100	85200			15-0050	17-0000		
350 Grizzly®	2007-2014				15-5590	15-0050	17-0000		
350 Raptor®	2005-2006				15-5531	15-0050	17-0000		
350 Wolverine®	05 & Older				15-5531	15-0050	17-0000		
400 Big Bear	2000-2012				15-5531	15-0050	17-0000		
400 Big Bear	2007-2014	85100	85200			15-0050	17-0000		
400 Grizzly®	2007-2014	85100	85200			15-0050	17-0000		
400 Kodiak®	2003-2006	85100	85200		15-5590	15-0050	17-0000		
450 Grizzly® (ALL)	2007-2014	85100	85200		15-5590	15-0050	17-0000		
450 Kodiak®	2005-2006	85100	85200		15-5590	15-0050	17-0000		
450 Kodiak®	2018-2025	85100	85200		15-5650	15-0050	17-0000		
550 Grizzly®	2009-2014	85100	85200		15-5640	15-0050	17-0000		25-5250
600 Grizzly®	01 & Older					15-0050	17-0000		
660 Grizzly®	2002-2008	85100	85200		15-5640	15-0050	17-0000		
700 Grizzly® (ALL)	2007-2018	85100	85200		15-5640	15-0050	17-0000		25-5250
700 Grizzly® (ALL)	2019-2025	OEM 2"	85200		15-5640	15-0050	17-0000	26-5000	25-5300
700 Kodiak® (ALL)	2016-2025	85100	85200		15-5640	15-0050	17-0000	26-5000	25-5300

		WINDSHIELDS									ROOFS		PLOW SYSTEM		QUICK-MOUNT WINCH KIT		
UTV MODEL	YEAR	GLASS	HALF-FIXED POLY WINDSHIELD	FULL-FIXED POLY WINDSHIELD	FULL-TILTING POLY WINDSHIELD	VENTED FULL FIXED POLY WINDSHIELD	REAR PANEL POLY WINDSHIELD			METAL	POLY	FRONT-CONNECT	SWITCHBLADE	SYNTH 3500 LB	SYNTH 4500 LB	UTV WINCH MOUNT	
<b>ARCTIC CAT® / TEXTRON®</b>									<b>ARCTIC CAT® / TEXTRON®</b>								
Wildcat® Trail/ Trail XT/ Sport/ Sport XT	2014-2017																OEM Equipped
Wildcat® / X / 4 / 4X / 1000 / GT 1000	2012-2017									1497 (NA 4 model)							OEM Equipped
Wildcat® X 1000	2015-2017																OEM Equipped
Stampede® 900 / 4X 900	2017-2020		2467	2468			2470										OEM Equipped
Havoc / Havoc X	2018-2020		2467	2468			2470										OEM Equipped
Prowler®	2009-2017																OEM Equipped
Prowler® HDX 700	2011-2017																25-6130
Prowler® Pro / Pro Crew	2019-2024													35-8000 c			25-6130
<b>BOBCAT®</b>									<b>BOBCAT®</b>								
3400	2015-2020	28110 b,e	2633				2644	2634		29110 a, g	27110 c, g						
3400 XL	2015-2020	28110 b,e	2633				2644	2634		29120 a, g	27105 c, g						
UV34	2019-2025	28110 b,e	2633				2644	2634		29110 a, g	27110 c, g	35-3050 k,m,o			26-3000		25-3400 b,e,f
UV34XL	2019-2025	28110 b,e	2633				2644	2634		29110 a, g	27105 c, g	35-3050 k,m,o			26-3000 <sub>a</sub>		25-3400 b,e,f
<b>CAN-AM®</b>									<b>CAN-AM®</b>								
Commander® 700 (DPS, XT)	2022-2025													35-7020 j			25-7110
Commander® MAX 700 (DPS, XT)	2024-2025													35-7020 j			25-7110
Commander® 1000 / 800 (All)	2011-2013		2707 UC			3000		2735						35-7010	17-5000		25-7070
Commander® 1000 / 800 (All)	2014-2020		2707 UC			3000		2743 (NA MAX)						35-7010	17-5000		25-7070
Commander® 1000 (DPS, XT, XTP) / MAX 1000 (DPS, XT, XTP)	2021-2025													35-7020 j			25-7110
Maverick® / X rs	2013			2708				2735							17-5000		25-7080
Maverick® / X rs	2014-2018			2708				2743 (NA MAX)							17-5000		25-7080
Maverick® X3	2017-2025	28410 b, e	3006							29410 d, g					17-5000		
Maverick® MAX X3	2017-2025	28410 b, e	3006							29430 d, g					17-5000		
Maverick® Trail 700	2022-2025													35-7020 j			25-7110

		WINDSHIELDS							ROOFS		PLOW SYSTEM		QUICK-MOUNT WINCH KIT		UTV WINCH MOUNT
UTV MODEL	YEAR	GLASS	HALF-FIXED POLY WINDSHIELD	FULL-FIXED POLY WINDSHIELD	FULL-TILTING POLY WINDSHIELD	VENTED FULL FIXED POLY WINDSHIELD	REAR PANEL POLY WINDSHIELD	METAL	POLY	FRONT-CONNECT	SWITCHBLADE	SYNTH 3500 LB	SYNTH 4500 LB		
<b>CAN-AM® CONT.</b>															
Maverick® Trail 800 (DPS, BASE)	2018-2021											35-7020 j			25-7110
Maverick® Trail 1000 (DPS, BASE)	2018-2025											35-7020 j			25-7110
Maverick® Sport 1000 (DPS, BASE, XMR, XRC, XXC) / MAX 1000	2019-2025											35-7020 j			25-7110
Maverick® Trail / Sport	2018-2022											35-7020	17-5000		25-7110
Maverick® Max	2013-2018			2708									17-5000		25-7080
Maverick® R	2024-2025														
Maverick® R Max	2025														
Defender® HD5 (DPS, BASE)	2017-2021	28400 b, e		3017	3015		3019			29400 a, d, g		35-7000	17-5000	26-7020	25-7110
Defender® HD7 (DPS, BASE)	2022-2025	28400 b, e		3017	3015		3019			29400 a, d, g		35-7000		26-7020	25-7110
Defender® HD8 (DPS, XT, BASE)	2016-2021	28400 b, e		3017	3015		3019			29400 a, d, g		35-7000	17-5000	26-7020	25-7110
Defender® HD8 (CAB Package)	2018-2021	28400 b, e		3017	3015		3019			29400 a, d, g		35-7000	17-5000	26-7020	25-7110
Defender® HD9 (DPS, XT, BASE)	2022-2025	28400 b, e		3017	3015		3019			29400 a, d, g		35-7000		26-7020	25-7110
Defender® HD9 (CAB Package)	2022-2025	28400 b, e		3017	3015		3019			29400 a, d, g		35-7000		26-7020	25-7110
Defender® HD10 (DPS, XT, BASE)	2016-2018	28400 b, e		3017	3015		3019			29400 a, d, g		35-7000	17-5000	26-7020	25-7110
Defender® HD10 (DPS, XT, BASE)	2019-2025	28400 b, e		3017	3015		3019			29400 a, d, g		35-7000		26-7020	25-7110
Defender® HD10 (CAB Package)	2018-2025	28400 b, e		3017	3015		3019			29400 a, d, g		35-7000		26-7020	25-7110
Defender® HD10 XTP	2018-2020	28400 b, e		3017	3015		3019			29400 a, d, g		35-7000	17-5000	26-7020	25-7110
Defender® HD10 XMR	2018-2025	28400 b, e		3017	3015		3019			29400 a, d, g		35-7000		26-7020	25-7110
Defender® MAX HD7 (BASE)	2022-2025	28400 b, e		3017	3015		3019			29420 a, d, g		35-7000		26-7020	25-7110
Defender® MAX HD8 (DPS/BASE)	2019-2021	28400 b, e		3017	3015		3019			29420 a, d, g		35-7000	17-5000	26-7020	25-7110
Defender® MAX HD8 (XT, CAB Package)	2019-2020	28400 b, e		3017	3015		3019			29420 a, d, g		35-7000	17-5000	26-7020	25-7110
Defender® MAX HD9 (DPS, XT, BASE)	2022-2025	28400 b, e		3017	3015		3019			29420 a, d, g		35-7000		26-7020	25-7110
Defender® MAX HD10 XMR	2019-2025	28400 b, e		3017	3015		3019			29420 a, d, g		35-7000		26-7020	25-7110

UTV MODEL	YEAR	WINDSHIELDS						ROOFS		PLOW SYSTEM		QUICK-MOUNT WINCH KIT		UTV WINCH MOUNT	
		GLASS	HALF-FIXED POLY WINDSHIELD	FULL-FIXED POLY WINDSHIELD	FULL-TILTING POLY WINDSHIELD	VENTED FULL FIXED POLY WINDSHIELD	REAR PANEL POLY WINDSHIELD	METAL	POLY	FRONT-CONNECT	SWITCHBLADE	SYNTH 3500 LB	SYNTH 4500 LB		
<b>CAN-AM® CONT.</b>										<b>CAN-AM® CONT.</b>					
Defender® MAX HD10 (DPS, XT, Lonestar, CAB Package)	2019-2025	28400 b, e		3017	3015		3019			29420 a, d, g		35-7000		26-7020	25-7110
Defender® MAX HD10 / HD8 (CAB Package, Lonestar)	2018	28400 b, e		3017	3015		3019			29420 a, d, g		35-7000	17-5000	26-7020	25-7110
Defender® MAX HD10 / HD8 (DPS, XT, BASE)	2017-2018	28400 b, e		3017	3015		3019			29400 a, d, g		35-7000	17-5000	26-7020	25-7110
Defender® 6x6 HD10 (DPS, XT) / PRO HD10 (DPS, XT) (All)	2020-2025	28400 b, e		3017	3015		3019			29400 a, d, g		35-7000		26-7020	25-7110
Defender® PRO HD10 (CAB Package, Lonestar)	2021-2025	28400 b, e		3017	3015		3019			29400 a, d, g		35-7000		26-7020	25-7110
<b>CATERPILLAR®</b>										<b>CATERPILLAR®</b>					
CUV82 / CUV85	2019-2021											35-8000 j			25-6130
CUV102 D / 105 D	2019-2021											35-8000 j			25-6130
<b>CUSHMAN®</b>										<b>CUSHMAN®</b>					
Hauler 4x4 / Crew (Gas & Diesel)	2019-2020											35-8000 j			25-6130
<b>CFMOTO®</b>										<b>CFMOTO®</b>					
UFORCE® 500 / 800	2013-2020											17-5000			
UFORCE® 600	2022-2025	28910 b, e					2906					35-9010 j			
UFORCE® 1000	2019-2025	28900 b, e					2907					35-9000	17-5000		
UFORCE® 800 XL	2025	28910 b, e										35-9010 j			
UFORCE® 1000 XL	2022-2025	28900 b, e					2907					35-9000	17-5000		
UFORCE® U10 Pro / U10 XL Pro	2025	28920 b, e										35-9030			
ZFORCE® 800 Trail (G2)	2023-2025											35-9020 L			
ZFORCE® 950 Sport (G2)	2023-2025											35-9020 L			
ZFORCE® 950 Sport 4 (G2)	2024-2025											35-9020 L			
ZFORCE® 950 Trail (G2)	2023-2025											35-9020 L			
ZFORCE® 500/800/1000	2014-2020											17-5000			
<b>GRAVELY®</b>										<b>GRAVELY®</b>					
Atlas JSV®	2015-2021											35-3000 j	17-5000		25-3400

		WINDSHIELDS									ROOFS		PLOW SYSTEM		QUICK-MOUNT WINCH KIT		
UTV MODEL	YEAR	GLASS	HALF-FIXED POLY WINDSHIELD	FULL-FIXED POLY WINDSHIELD	FULL-TILTING POLY WINDSHIELD	VENTED FULL FIXED POLY WINDSHIELD	REAR PANEL POLY WINDSHIELD			METAL	POLY	FRONT-CONNECT	SWITCHBLADE	SYNTH 3500 LB	SYNTH 4500 LB	UTV WINCH MOUNT	
<b>HONDA®</b>									<b>HONDA®</b>								
Big Red®	2009-2013													17-5000			25-1180
Pioneer® 500	2015-2023		2761			2760								35-1020 L	17-5000		25-1250
Pioneer® 520	2021-2025		2761			2760								35-1020 L			25-1250
Pioneer® 700 (2-passenger)	2014-2025	28210 f	2772	2722	2737	2793	2724			29215 d	27125	35-1010 L	17-5000	26-1040			25-1280
Pioneer® 700-4 (4-passenger)	2014-2025	28210 f	2772	2722	2737	2793	2724			29220 d		35-1010 L	17-5000	26-1040			25-1280
Pioneer® 1000 (3-passenger)	2016-2025	28200 e				2795	2788			29200 d		35-1000			26-1000		25-1290
Pioneer® 1000-5 (5-passenger)	2016-2025	28200 e				2795				29210 d		35-1000	17-5000		26-1000		25-1290
Pioneer® 1000-6 (6-passenger)	2023-2025	28200 e				2795						35-1000			26-1000		25-1290
Talon® 1000 R (2-passenger)	2019-2025	28220 b, f				2794				29230 d,g		35-1030	17-5000		26-1050		25-1300
Talon® 1000 X (2-passenger)	2019-2025	28220 b, f				2794				29230 d, g		35-1030	17-5000		26-1050		25-1300
Talon® 1000 XS (2-passenger)	2023	28220 b, f				2794				29230 d, g		35-1030			26-1050		25-1300
Talon® 1000 RS (2-passenger)	2023	28220 b, f				2794				29230 d, g		35-1030			26-1050		25-1300
Talon® 1000X-4 (4-passenger)	2020-2025	28220 b, f				2794				29240 d, g		35-1030			26-1050		25-1300
Talon® 1000R-4 (4-passenger)	2023-2025	28220 b, f				2794				29240 d, g		35-1030					
<b>JOHN DEERE®</b>									<b>JOHN DEERE®</b>								
XUV 625i / 620i / 825i / 850D / 855D / HPX 4x4	2004-2012			2900 H										35-4010			25-8810
XUV 625i	2012-2021			2900 H			2744 p							35-4010	17-5000		25-8810
XUV 825E / 825i / 825M / 825i S4 / 825M S4	2012-2025			2900 H			2744 p							35-4010			25-8810
XUV 855E / 855D / 855M / 855D S4 / 855M S4	2012-2025		2716	2900 H			2734 p							35-4010	17-5000		25-8810
HPX 615E / 815E	2018-2025			2900 H			2744 p							35-4010			25-8810
RSX850i	2013-2015			2716	2903		2734							17-5000			25-8820*
RSX860i / 860M	2016-2021			2716	2903		2734							17-5000			25-8820*
XUV 550 / 550 S4 / 560 / 560E / 560 S4 / 560E S4	2012-2025			2716	2903		2734							35-4020	17-5000		25-8820*
XUV 590E / 590i / 590M / 590E S4 / 590i S4 / 590M S4	2012-2025			2716	2903		2734							35-4020			25-8820*

		WINDSHIELDS									ROOFS		PLOW SYSTEM		QUICK-MOUNT WINCH KIT		
UTV MODEL	YEAR	GLASS	HALF-FIXED POLY WINDSHIELD	FULL-FIXED POLY WINDSHIELD	FULL-TILTING POLY WINDSHIELD	VENTED FULL FIXED POLY WINDSHIELD	REAR PANEL POLY WINDSHIELD			METAL	POLY	FRONT-CONNECT	SWITCHBLADE	SYNTH 3500 LB	SYNTH 4500 LB	UTV WINCH MOUNT	
<b>JOHN DEERE® CONT.</b>									<b>JOHN DEERE® CONT.</b>								
XUV 835E / 835M / 835R / 865E / 865M / 865R	2018-2024													35-4000			25-7110*
XUV 845E / 845M / 845R / 875E / 875M / 875R	2025													35-4000			25-7110*
<b>HAWASAKI®</b>									<b>HAWASAKI®</b>								
Teryx® 750	2008-2013				1460									35-2010	17-5000		25-2320
Teryx® 800	2014-2015				1462		1466							35-2010	17-5000		25-2320*
Teryx® 800 (2-passenger)	2016-2024	28310 e			1468		1466			29315				35-2010	17-5000		25-2320*
Teryx® 800 S	2021-2025	28310 e			1468		1466			29315				35-2010			25-2320*
Teryx® 4 800 S	2021-2024	28310 e			1468					29310				35-2010			25-2320*
Teryx® 4 750	2012-2013				1462									35-2010	17-5000		25-2320*
Teryx® 4 800	2014-2015	28310 e			1462					29310				35-2010	17-5000		25-2320*
Teryx® 4 800 (4-passenger)	2016-2025	28310 e			1468					29310				35-2010	17-5000		25-2320*
Teryx® KRX 1000	2020-2025													35-2050 L			25-2380
Teryx® KRX 4 1000	2023-2025													35-2050 L			25-2380
Mule 3000 / 3010	2008 & Older																OEM Equipped
Mule 4000 / 4010 / Trans / Diesel	2009-2012				2900 H									35-2040 k	17-5000		25-2330
Mule 4000 / 4010 / Trans / Diesel	2013-2025			2524	2900 H									35-2040 k	17-5000		25-2340*
Mule Pro - FXT	2015-2023	28300 b, e		2524	2520					29300				35-2000 L		26-2000	25-2370
Mule Pro - FXT 1000	2024-2025	28300 b, e		2524	2520					29300				35-2000 L		26-2000	25-2370
Mule Pro - FXT 820	2025	28300 b, e		2524	2520					29300				35-2000 L		26-2000	25-2370
Mule Pro - DXT (6-pass)	2016-2025	28300 b, e		2524	2520					29300				35-2000 L		26-2000	25-2370
Mule Pro - DX	2016-2022	28300 b, e		2524	2520					29320				35-2000 L		26-2000	25-2370
Mule Pro - FX	2016-2023	28300 b, e		2524	2520					29320				35-2000 L		26-2000	25-2370
Mule Pro - FX 820	2025	28300 b,e		2524	2520					29320				35-2000 L		26-2000	25-2370
Mule Pro - FX 1000	2024-2025	28300 b, e		2524	2520					29320				35-2000 L		26-2000	25-2370

		WINDSHIELDS									ROOFS		PLOW SYSTEM		QUICK-MOUNT WINCH KIT		
UTV MODEL	YEAR	GLASS	HALF-FIXED POLY WINDSHIELD	FULL-FIXED POLY WINDSHIELD	FULL-TILTING POLY WINDSHIELD	VENTED FULL FIXED POLY WINDSHIELD	REAR PANEL POLY WINDSHIELD			METAL	POLY	FRONT-CONNECT	SWITCHBLADE	SYNTH 3500 LB	SYNTH 4500 LB	UTV WINCH MOUNT	
<b>HAWASAKI® CONT.</b>									<b>HAWASAKI® CONT.</b>								
Mule Pro - FXR	2018-2023											35-2000 L			26-2000	25-2370	
Mule Pro - FXR 1000	2024-2025											35-2000 L			26-2000	25-2370	
Mule Pro - MX	2019-2025											35-2030 j	17-5000			OEM Equipped*	
Mule 600 / 610 / 610 XC	2005-2016				2510								17-5000			25-2240	
Mule SX	2017-2025				2512 H		2513					35-2020	17-5000			25-2360	
Ridge 1000	2024-2025											35-2060					
Ridge 1000 Crew	2025											35-2060					
<b>HUBOTA®</b>									<b>HUBOTA®</b>								
RTV900 / 1140 / RTV-X Series	2009-2019												17-5000				
<b>HYMCO</b>									<b>HYMCO</b>								
UXV 450	2015-2020												17-5000				
UXV 500/700	2009-2020												17-5000				
<b>POLARIS</b>									<b>POLARIS</b>								
Brutus HD / HDPTO	2013-2018	28110 b, e	2633 UC	2629	2623		2634			29110 a	27110 c						
XPEDITION XP / XP 5 / ADV / ADV 5	2024-2026											35-3100					
General 1000 (ALL)	2016-2026											35-3020	17-5000			25-3360	
General 4 1000 (ALL)	2017-2025											35-3020	17-5000			25-3360	
General XP 1000 (ALL)	2020-2026											35-3020	17-5000			25-3360	
General XP 4 1000 (ALL)	2020-2026											35-3020	17-5000			25-3360	
Ranger 150	2018-2025			2150 r			2150 r				2150 r						
Ranger 400 / EV	2010-2014				2630		2732					35-3010 q	17-5000	26-3025		25-3420	
Ranger ETX / EV / EV LI-ION	2015-2022	28115 b, e				2646	2773			29115 a, g	27115 c, g	35-3010 q	17-5000	26-3025		25-3420	
Ranger TM 2x4 Full-Size	2004-2006											35-3060 q				25-3221	
Ranger 425 2x4 Full-Size	2001-2004											35-3060 q				25-3221	

UTV MODEL		YEAR	WINDSHIELDS						ROOFS		PLOW SYSTEM		QUICK-MOUNT WINCH KIT		UTV WINCH MOUNT
			GLASS	HALF-FIXED POLY WINDSHIELD	FULL-FIXED POLY WINDSHIELD	FULL-TILTING POLY WINDSHIELD	VENTED FULL FIXED POLY WINDSHIELD	REAR PANEL POLY WINDSHIELD	METAL	POLY	FRONT-CONNECT	SWITCHBLADE	SYNTH 3500 LB	SYNTH 4500 LB	
<b>POLARIS CONT.</b>															
Ranger 500 2x4 Full-Size	2001-2004											35-3060 q	17-5000		25-3221
Ranger 500 2x4 Full-Size	2005-2008				2611		2730					35-3060 q	17-5000		25-3221
Ranger 500 4x4 Full-Size	2003-2004											35-3060 q	17-5000		25-3221
Ranger 500 4x4 Full-Size	2005-2008				2611		2730					35-3060 q	17-5000		25-3221
Ranger 500 6x6 Full-Size	2002-2005											35-3060 q	17-5000		25-3221
Ranger 500 6x6 Full-Size	2005				2611		2730					35-3060 q	17-5000		25-3221
Ranger 500 Full-Size	2009						2731		29130			35-3010 q	17-5000		25-3420
Ranger 500 Full-Size	2010	28130 b, e			2621		2731		29130			35-3010 q	17-5000		25-3420
Ranger 500 Mid-Size	2026	28135											17-5000		
Ranger 500 (Mid-Size, Round Tube)	2011-2013				2630		2732					35-3010 q	17-5000	26-3025	25-3420
Ranger 500 (Mid-Size, Round Tube)	2017-2022	28115 b, e				2646	2773		29115 a, g	27115 c, g		35-3010 q	17-5000	26-3025	25-3420
Ranger 500 Crew (Mid-Size, Round Tube)	2011-2013				2630		2732					35-3010 q	17-5000	26-3025	25-3420 <sub>a</sub>
Ranger 570 EFI (Mid-Size, Round Tube)	2014				2630		2732					35-3010 q	17-5000	26-3025	25-3420
Ranger 570 (Mid-Size, Profile Tube)	2015-2021	28115 b, e				2646	2773		29115 a, g	27115 c, g		35-3010 q	17-5000	26-3025	25-3420
Ranger 570 Crew (Mid-Size, Profile Tube)	2014				2630		2773						17-5000	26-3025	25-3420
Ranger 570 Crew (Mid-Size, Profile Tube)	2015-2021	28115 b, e			2745	2646	2773		29125 a, g, h			35-3010 j	17-5000	26-3025 <sub>a</sub>	25-3420 <sub>a</sub>
Ranger 570 (Full-Size, Round Tube)	2016-2025	28130 b, e			2621		2731		29130			35-3010 c	17-5000	26-3025	25-3420
Ranger 570 Crew (Full-Size, Round Tube)	2016-2025	28130 b, e			2621		2731		29160			35-3010	17-5000	26-3025 <sub>a</sub>	25-3420 <sub>a</sub>
Ranger XP 570 (Profile Tube)	2015-2016	28110 b, e	2633 UC	2629	2623		2634		29110 a, g	27110 c, g		35-3000 a	17-5000	26-3000	25-3400
Ranger XP 570 Crew (Profile Tube)	2015-2016	28110 b, e	2633 UC	2629	2623		2634		29120 a, g	27105		35-3010	17-5000	26-3000 <sub>a</sub>	25-3400
Ranger SP 570 (All except base model)	2022-2026	28115 b, e			2779	2646	2773		29115 a, g	27115 c, g	OEM Equipped			26-3040	25-3430
Ranger Crew SP 570 (All except base model)	2022-2026	28115 b, e			2779	2646	2773		29125 a, g, h		OEM Equipped			26-3040 <sub>a</sub>	25-3430 <sub>a</sub>
Ranger SP 570 Base Model (Non-EPS)	2022-2026	28115 b, e			2779	2646	2773		29115 a, g	27115 c, g		35-3080		26-3040	25-3430

UTV MODEL	YEAR	WINDSHIELDS					
		GLASS	HALF-FIXED POLY WINDSHIELD	FULL-FIXED POLY WINDSHIELD	FULL-TILTING POLY WINDSHIELD	VENTED FULL FIXED POLY WINDSHIELD	REAR PANEL POLY WINDSHIELD

ROOFS		PLOW SYSTEM		QUICK-MOUNT WINCH KIT		UTV WINCH MOUNT
METAL	POLY	FRONT-CONNECT	SWITCHBLADE	SYNTH 3500 LB	SYNTH 4500 LB	

**POLARIS CONT.**

**POLARIS CONT.**

Ranger Crew SP 570 Base Model (Non-EPS)	2022-2026	28115 b, e			2779	2646	2773			29125 a, g, h		35-3080	17-5000	26-3040 <sub>a</sub>		25-3430
Ranger 700 4x4 Full-Size	2005-2008				2611		2730					35-3060 q	17-5000			25-3221*
Ranger 700 4x4 Full-Size Crew	2008-2009				2611		2730					35-3060 q	17-5000			25-3221
Ranger 700 4x4 Full-Size	2009											35-3010 q	17-5000			25-3420
Ranger 700 6x6 Full-Size	2006-2009				2611		2730					35-3060 q	17-5000			25-3221
Ranger 800 6x6 Full-Size	2010-2016	28130 b, e			2621		2731			29130		35-3010 q	17-5000			25-3420
Ranger 800 Mid-Size	2013-2015				2630		2732					35-3010 q	17-5000	26-3025		25-3420
Ranger XP 800 Full-Size	2010-2017	28130 b, e			2621		2731			29130		35-3010 q	17-5000	26-3025		25-3420
Ranger XP 800 Crew Full-Size	2010-2014	28130 b, e			2621		2731			29160		35-3010 q	17-5000			25-3420 <sub>a</sub>
Ranger XP 900 (Profile Tube)	2013-2019	28110 b, e	2633 UC	2629	2623		2634			29110 b, e	27110 c, g	35-3000 q	17-5000		26-3000	25-3400
Ranger XP 900 Crew (Profile Tube)	2014-2019	28110 b, e	2633 UC	2629	2623		2634			29120 a, g	27105 c, g	35-3000 j	17-5000		26-3000 <sub>a</sub>	25-3400 <sub>a</sub>
Ranger XP 1000 (Profile Tube)	2017	28110 b, e	2633 UC	2629	2623		2634			29110 a, g	27110 c, g	35-3000 j	17-5000		26-3000	25-3400
Ranger XP 1000 (Profile Tube)	2018-2026	28110 b, e	2633 UC			2644	2634			29110 a, g	27110 c, g	OEM Equipped	17-5000		26-3000	25-3400
Ranger XP 1000 Crew (Profile Tube)	2017-2018	28110 b, e	2633 UC	2629	2623		2634			29120 a, g	27105 c, g	35-3000 j	17-5000		26-3000 <sub>a</sub>	25-3400
Ranger XP 1000 Crew (Profile Tube)	2019-2026	28110 b, e	2633 UC			2644	2634			29120 a, g	27105 c, g	OEM Equipped	17-5000		26-3000	25-3400
Ranger 1000 (All except base model)	2020-2026	28110 b, e	2633 UC			2644	2634			29110 a, g	27110 c, g	OEM Equipped	17-5000		26-3000	25-3400
Ranger 1000 Crew (All except base model)	2020-2026	28110 b, e	2633 UC			2644	2634			29120 a, g	27105 c, g	OEM Equipped	17-5000		26-3000	25-3400
Ranger 1000 Base Model Only (Non-EPS)	2020-2026	28110 b, e	2633 UC			2644	2634			29110 a, g	27110 c, g	35-3050 m	17-5000		26-3000	25-3400
Ranger 1000 Crew Base Model Only (Non-EPS)	2020-2026	28110 b, e	2633 UC			2644	2634			29120 a, g	27105 c, g	35-3050 m	17-5000		26-3000	25-3400
Ranger XP 1000 High Lifter Edition	2019-2022	28110 b, e	2633 UC			2644	2634			29110 a, g	27110 c, g	35-3070 j	17-5000			
Ranger XP 1000 Crew High Lifter Edition	2019-2022	28110 b, e	2633 UC			2644	2634			29120 a, g	27105 c, g	35-3070 j	17-5000			
Ranger XP 1000 Big Game / Waterfowl Edition	2021-2022	28110 b, e	2633 UC			2644	2634			29110 a, g	27110 c, g	35-3070 q	17-5000			
Ranger XP 1000 Crew Big Game / Waterfowl Edition	2021-2025	28110 b, e	2633 UC			2644	2634			29120 a, g	27105 c, g	35-3070 q	17-5000			

		WINDSHIELDS									ROOFS		PLOW SYSTEM		QUICK-MOUNT WINCH KIT		
UTV MODEL		YEAR	GLASS	HALF-FIXED POLY WINDSHIELD	FULL-FIXED POLY WINDSHIELD	FULL-TILTING POLY WINDSHIELD	VENTED FULL FIXED POLY WINDSHIELD	REAR PANEL POLY WINDSHIELD			METAL	POLY	FRONT-CONNECT	SWITCHBLADE	SYNTH 3500 LB	SYNTH 4500 LB	UTV WINCH MOUNT
POLARIS CONT.									POLARIS CONT.								
Ranger 900 Diesel	2011-2014	28130 b, e			2621		2731			29130		35-3010 q	17-5000				25-3420
Ranger Diesel / HST	2015-2018	28110 b,e	2633 UC	2629	2623		2634			29110 a	27110 c	35-3000 q	17-5000		26-3000		25-3400
Ranger Diesel Crew	2012-2014	28130 b, e			2621		2731			29160		35-3010 q	17-5000				25-3420
Ranger Diesel Crew	2015-2018	28110 b, e	2633 UC	2629	2623		2634			29120 a	27105	35-3000 q	17-5000		26-3000 <sub>a</sub>		25-3270
Ranger XP Kinetic (Profile Tube)	2023-2024	28110 b, e	2633 UC				2644	2634		29110 a, g	27110 c, g	OEM Equipped	17-5000		26-3000		25-3400
Ranger XD 1500	2024-2026											OEM Equipped					25-3450
Ranger XD 1500 Crew	2024-2026											OEM Equipped					25-3450
Pro XD Full-Size Gas	2019-2026	28110 b, e	2633 UC				2644	2634		29110 a, g	27110 c, g	35-3000 q	17-5000		26-3000		25-3400
Pro XD Crew Full-Size Gas	2019-2026	28110 b, e	2633 UC				2644	2634		29120 a, g	27105 c, g	35-3000 q	17-5000		26-3000		25-3400
Pro XD Full-Size Diesel	2022-2026	28110 b,e	2633 UC				2644	2634		29110 a, g	27110 c, g	35-3000 q			26-3000		25-3400
Pro XD Full-Size Diesel Crew	2022-2026	28110 b,e	2633 UC				2644	2634		29120 a, g	27105 c, g	35-3000 q			26-3000		25-3400
Pro XD Mid-Size	2022-2026	28115 b, e			2779	2646	2773			29115 a, g	27115 c, g	OEM Equipped	17-5000	26-3040			25-3040
Pro XD Crew Mid-Size	2022-2026	28115 b, e			2779	2646	2773			29125 a, g, h		OEM Equipped	17-5000	26-3040			25-3040
Pro XD Full-Size Kinetic	2025	28110 b,e	2633 UC				2644	2634		29110 a, g	27110 c, g	35-3000 q					25-3400
RZR 170	2009-2021			2100 &			2100 &				2100 &						
RZR 200	2022-2026			2110 &			2100 &				2110 &						
RZR 570 / S 570	2011-2022				2010	2007	2726					35-3040	17-5000				25-3270
RZR 800	2008-2010 2012-2015				2010	2007	2726					35-3040	17-5000				25-3270
RZR 800	2011				2010	2007						35-3040	17-5000				25-3270
RZR 800 S	2009-2010 2012-2014				2010	2007	2726					35-3040	17-5000				25-3270
RZR 800 S	2011				2010	2007						35-3040	17-5000				25-3270
RZR 4 800 (4-Passenger)	2010-2014				2010	2007						35-3040	17-5000				25-3270
RZR XP 900	2011				2010	2007						35-3040	17-5000				

		WINDSHIELDS									ROOFS		PLOW SYSTEM		QUICK-MOUNT WINCH KIT		
UTV MODEL		YEAR	GLASS	HALF-FIXED POLY WINDSHIELD	FULL-FIXED POLY WINDSHIELD	FULL-TILTING POLY WINDSHIELD	VENTED FULL FIXED POLY WINDSHIELD	REAR PANEL POLY WINDSHIELD			METAL	POLY	FRONT-CONNECT	SWITCHBLADE	SYNTH 3500 LB	SYNTH 4500 LB	UTV WINCH MOUNT
POLARIS CONT.									POLARIS CONT.								
RZR XP 900	2012-2014					2010	2007						35-3040	17-5000			
RZR 900 / S 900 / S 1000	2015-2020	28100 b, f	2771	2739	2738					29100 (Steel) 29105 (Alum) d, g	27100 c, d, g	35-3030	17-5000				25-3360
RZR XP 4 900	2012-2014					2010							35-3040	17-5000			
RZR XP 4 900	2015-2018	28100 b, f	2771	2739	2738					29150 d, g		35-3030	17-5000				25-3360
RZR 900 Trail (All 50")	2021-2026											35-3030 n	17-5000				25-3360
RZR 900 Trail S (All 60")	2021-2025											35-3030 n	17-5000				25-3360
RZR 1000 Trail S (All 60")	2021-2026											35-3030 n	17-5000				25-3360
RZR XP 1000 (All)	2014-2018	28100 b, f	2771	2739	2738			2742		29100 (Steel) 29105 (Alum) d, g	27100 c, d, g	35-3030	17-5000				25-3360
RZR XP 1000 (All)	2019-2023	28140 b, f	2756	2755	2754			2742		29100 (Steel) 29105 (Alum) d, g	27100 c, d, g	35-3030	17-5000				25-3360
RZR XP 1000 (All 2 passenger)	2024-2025			2790		2791	2792					35-3090	17-5000		26-3300		25-3440
RZR XP 4 1000 (All 4 passenger)	2014-2018	28100 b, f	2771	2739	2738			2753		29150 d, g		35-3030	17-5000				25-3360
RZR XP 4 1000 (All 4 passenger)	2019-2023	28140 b, f	2756	2755	2754			2753		29150 d, g		35-3030	17-5000				25-3360
RZR XP 4 1000 (All 4 passenger)	2024-2025			2790	2791	2791	2792					35-3090	17-5000		26-3300		25-3440
RZR S4 1000	2019-2020	28100 b, f	2771	2739	2738					29150 d, g		35-3030	17-5000				25-3360
RZR XP Turbo 1000	2016-2018	28100 b, f	2771	2739	2738			2742		29100 (Steel) 29105 (Alum) d, g	27100 c, d, g	35-3030	17-5000				25-3360
RZR Turbo S / XP Turbo S	2018-2021												17-5000				
RZR XP Turbo	2019-2021	28140 b, f	2756	2755	2754			2742		29100 (Steel) 29105 (Alum) d, g	27100 c, d, g	35-3030	17-5000				25-3360
RZR XP 4 Turbo	2016-2018	28100 b, f	2771	2739	2738			2753		29150 d, g		35-3030					25-3360
RZR XP 4 Turbo	2019-2024	28140 b, f	2756	2755	2754			2753		29150 d, g		35-3030	17-5000				25-3360
RZR Pro XP	2020-2026	28120 b, f								29140							25-3460
RZR Pro XP 4	2020-2026	28120 b, f															25-3460

		WINDSHIELDS									ROOFS		PLOW SYSTEM		QUICK-MOUNT WINCH KIT		
UTV MODEL		YEAR	GLASS	HALF-FIXED POLY WINDSHIELD	FULL-FIXED POLY WINDSHIELD	FULL-TILTING POLY WINDSHIELD	VENTED FULL FIXED POLY WINDSHIELD	REAR PANEL POLY WINDSHIELD			METAL	POLY	FRONT-CONNECT	SWITCHBLADE	SYNTH 3500 LB	SYNTH 4500 LB	UTV WINCH MOUNT
<b>POLARIS CONT.</b>									<b>POLARIS CONT.</b>								
RZR Turbo R		2022-2024	28120 b, f								29140						
RZR Turbo R 4		2022-2024	28120 b, f														
RZR Pro R / Pro R 4		2025															
RZR Pro S / Pro S 4		2025-2026															
<b>TRACHER</b>									<b>TRACHER</b>								
800 SX		2019-2024											35-8000 j	17-5000			25-6130
800SX Crew		2019-2024											35-8000 j	17-5000			25-6130
<b>YAMAHA®</b>									<b>YAMAHA®</b>								
Rhino		2004-2013				1487								17-5000			25-5260
Wolverine® 700		2016-2018				2780		2781						17-5000			25-5310
Wolverine® X2 850		2019	28500 b, f							29500				17-5000			25-5310
Wolverine® X2 850		2020	28500 b, f							29500			35-5000	17-5000			OEM Equipped*
Wolverine® X2 850		2021-2025											35-5000	17-5000			OEM Equipped*
Wolverine® X2 1000		2024-2025											35-5000				OEM Equipped*
Wolverine® X4 850		2018-2019	28500 b, f							29510				17-5000			25-5310
Wolverine® X4 850		2020	28500 b, f							29510			35-5000	17-5000			OEM Equipped*
Wolverine® X4 850		2021-2025											35-5000	17-5000			OEM Equipped*
Wolverine® 1000 RMAX2		2021-2025											35-5020	17-5000			25-7110
Wolverine® 1000 RMAX4		2021-2025											35-5020	17-5000			25-7110
Viking® 700 (3 passenger)		2014-2025				2736							35-5010	17-5000			25-5310
Viking® 700 VI (6 passenger)		2015-2025				2736							35-5010 k, j	17-5000			25-5310
YXZ 1000R (All)		2016-2018						2783									
<b>YANMAR</b>									<b>YANMAR</b>								
Bull		2017-2023											35-5010 k, j				25-5310
Longhorn		2017-2023											35-5010 k, j				25-5310







# KOLPIN WARRANTY

## KOLPIN'S COMMITMENT TO YOU

At Kolpin Outdoors, we stand behind every product we make and take care of every one of our customers. It's a promise Howard Kolpin first made in 1943, and one we continue to uphold to this day.

If your Kolpin product fails or doesn't live up to your expectations, please reach out to our technical service team; they'll be happy to answer your questions or assist you with necessary repairs or replacements.

**Email us at [customerservice@kolpin.com](mailto:customerservice@kolpin.com) or call us at 877-9-KOLPIN. We still answer the phone.**

Our Warranty does not cover damages caused by improper care, usage, accidents or natural breakdown of materials over extended use and time defined at Kolpin's discretion.

- Kolpin products are warranted against defects in materials and workmanship for 1 Year from the date of purchase.
- Kolpin winches are warranted against defects in materials and workmanship for 5 Years on mechanical components and 3 Years for electrical components from the date of purchase.
- Kolpin UTV Conqueror Front-Connect, High-Rise & Storm Chaser Push Tubes & Mounts are warranted against defects in materials & workmanship for 2 years from the date of purchase
- Kolpin Switchblade Plow Systems and Plow Accessories are warranted against defects in materials & workmanship for 1 years from the date of purchase.

Disclaimer: Kolpin Outdoors reserves the right to make changes in our products without notice as the need arises. At the time of printing, we believe all specifications and applications are correct but are subject to change. All of our application and fitment charts for Kolpin Outdoors products can be found online at: <https://www.kolpin.com/fitment-guides>

⚠ This product is designed to fit most vehicles, however Kolpin does not guarantee vehicle fitment for all vehicles. See [kolpin.com](https://www.kolpin.com) for the latest vehicle fitment. We reserve the right to make modifications / improvements to our products at any time. Pictures are a representation of the product you will be getting but may vary due to product revisions.



Designed & Printed in the USA

© Polaris Industries, Inc.

The following are trademarks and registered trademarks of the following companies:

Arctic Cat®, Alterra®, Wildcat® and Prowler® are registered trademarks of Arctic Cat Inc.; Stampede® and Textron® are registered trademarks of Textron, Inc.; Bobcat® is a registered trademark of Clark Equipment Company Corporation; Defender®, Can-Am®, LinQ®, Commander®, Maverick® and Renegade® are registered trademarks of Bombardier Recreational Products Inc.; CFMOTO®, FORCE®, UFORCE®, ZFORCE® are registered trademarks of Zhejiang CFMoto Power Co., Ltd.; Caterpillar® is a registered trademark of Caterpillar Inc.; Cushman® is a registered trademark of Textron Innovations Inc.; Honda®, Fourtrax®, Foreman®, Pioneer®, BIG RED®, TALON®, Rancher®, and Rincon® are registered trademarks of Honda Motor Company, Ltd.; RUBICON® is a registered trademark of FCA US LLC; Kawasaki®, Brute Force®, and Teryx® are registered trademarks of Kawasaki Heavy Industries, Ltd.; Suzuki®, and KingQuad®, are registered trademarks of Suzuki Motor Corporation; Yamaha®, Grizzly®, Kodiak®, Viking®, Raptor®, and Wolverine® are registered trademarks of Yamaha Hatsudoki Kabushiki Kaisha; Gravelly® and Atlas JSV® are registered trademarks of Ariens Company; John Deere® are registered trademarks of Deere & Company; Toro®, Dingo® and Workman® are registered trademarks of The Toro Company; Kubota® is a registered trademark of Kubota Corporation; New Holland® is a registered trademark of CNH Industrial N.V.; Bluetooth® is a registered trademark of Bluetooth Sig, Inc.; Some Kolpin products may include chemicals known under California Proposition 65 to cause cancer or reproductive toxicity.

# 2025-26

Kolpin Outdoors, Inc.  
9955 59th Ave N  
Plymouth, MN 55442

[www.kolpin.com](http://www.kolpin.com)

Telephone: (763) 478-5800  
Toll Free: (877) 956-5746  
Email: [customerservice@kolpin.com](mailto:customerservice@kolpin.com)

Copyright 2025  
Designed & Printed in the USA



SHARE YOUR #KOLPIN ADVENTURES WITH US

