

TABLE OF CONTENTS

Introduction	1-1
Congratulations	1-1
About This Manual	1-1
About Your New Boat	1-2
Boat Terminology	1-2
Hull Identification, Capacity and Safety Plates	1-2
References and Contact Information	1-4
Boat Information Form	1-7
Tiller Specifications	1-9
Dual Console Specifications	1-10
Safety	2-1
Good Boating Practices	2-1
Safety Decals and Statements	2-4
Safety Decals	2-4
Safety Statements	2-9
Safety Precautions	2-10
Carbon Monoxide (CO)	2-14
Required Boating Safety Equipment and Regulations	2-16
Fire Extinguisher	2-18
Engine Emergency Stop Switch and Lanyard	2-18
Life Jackets	2-19
Visual Distress Signaling Devices	2-23
Audible Signaling Devices	2-24
Navigational Lights	2-25
Unapproved Lighting	2-25
Recommended Safety Equipment	2-26
Safety and Training	2-27
Special Needs Passengers	2-27
Seating	2-29
Very High Frequency (VHF) Radio	2-30
Cruising Limitations	2-31
Hazard Information	2-31
Water Sports	2-32
Platform Dragging	2-32
Water Sports Guidelines	2-33



TABLE OF CONTENTS

Boating Regulations and Your Responsibilities	3-1
Boat Owner / Operator Responsibilities	3-1
Safety	3-1
Registration	3-2
Insurance	3-2
Reporting Accidents	3-2
Boating Under the Influence	3-3
Operator's License and Education	3-3
Operation By Minors	3-3
Emergency Assistance	3-4
Negligent Operation	3-4
Restricted Areas	3-4
Security Zones	3-4
Naval Vessel Protection Zones	3-5
Commercial Shipping Safety Zones	3-5
Bridges and Shipping Channels	3-5
America's Waterway Watch	3-5
Fishing	3-5
Monofilament Fishing Line	3-6
Wake	3-6
Noise	3-6
Speed	3-7
Shallow Water Boat Stability	3-7
Protecting the Environment	3-7
MARPOL Treaty	3-8
Aquatic Invasive Species (AIS)	3-8
Paints	3-9
Cleaning Agents	3-9
Exhaust Emissions	3-9
Additional Proposition 65 Information	3-9
Emergencies	4-1
First Aid / Medical Emergencies	4-1
Emergency Preparation Checklist	4-1
Using Distress Signal Devices and Calling for Help	4-1
Requesting Assistance (Non-Distress Call)	4-2
Law of Salvage	4-3



Fire and Explosion	4-3
Man Overboard (MOB)	4-4
Capsizing and Flooding	4-5
Running Aground	4-6
Dangerous Weather	4-6
Engine or Boat System Failure	4-6
Accidents, Collisions and Giving Assistance	4-7
Towing on the Water	4-7
Hurricane and Severe Weather Preparedness	4-8
Protecting the Boat from Theft	4-9
Operating in Hazardous Conditions	5-1
Severe Weather	5-1
Storm Conditions	5-1
Fog Conditions	5-2
Reduced Visibility	5-2
Cold Weather and Cold or Frozen Water Conditions	5-2
Water Hazards	5-2
Aquatic Vegetation/Weeds	5-3
Dams and Spillways	5-3
Shallow Water Operation	5-3
Markers, Warnings and Advisories	5-4
Boat Flags	5-4
Harbor Flags and Indicators	5-5
Navigation Rules and Aids	6-1
Right-of-Way	6-1
The General Prudential Rule	6-1
Navigational Lights and Night Operation	6-1
Audible Signals	6-2
Overtaking / Passing	6-3
Meeting Head-On	6-4
Crossing	6-5
Aids to Navigation	6-6
Buoys	6-6
Mooring Buoys	6-7
Daymarks / Dayboards	6-7
Lights and Lighted Structures	6-7



TABLE OF CONTENTS

Markers	6-9
Operating the Boat	7-1
Before Getting Underway	7-1
Safety Equipment	7-1
Float Plan	7-1
Pre-Departure Safety Checklist	7-2
Boarding	7-3
Boat Loading	7-4
Fueling	7-5
Fuel Management	7-5
Fuel Suppliers	7-5
Static Electricity and the Fuel System	7-5
Fuel (Gasoline)	7-6
Before Refueling	7-7
Fueling	7-7
Refueling Built-In Fuel Tanks	7-8
After Refueling	7-8
Outboard Engine Fueling Considerations	7-8
Getting Underway	7-8
Starting	7-9
Steering	7-9
Stopping	7-11
Shifting	7-12
Accelerating and Running Underway	7-12
Checks During and After Operation	7-14
Power Trim and Tilt	7-14
Power Trim Operation	7-14
Docking	7-17
Mooring	7-18
Anchors and Anchoring	7-19
Lines and Knots	7-21
Trailering and Launching	8-1
Legal Considerations	8-1
Trailer Classification	8-1
Trailer Type	8-1
Trailer Gross Vehicle Weight Rating	8-2
Towing Vehicle	8-2



Vehicle Towing Hitch	8-2
Hitch Ball and Trailer Coupler	8-3
Safety Chains	8-4
Trailer Brakes	8-5
5-Pin Wiring Connector	8-5
Trailer Guidelines	8-6
Backing Up	8-9
Launching	8-9
Loading Guidelines	8-11
Reporting Safety Defects	8-12
Boat Features and Options	9-1
Fuel System	9-1
Engine Lubrication System	9-2
Engine Cooling System	9-2
Steering System	9-3
Shift and Throttle Controls	9-4
Single-Lever Controls - Single or Twin Engine	9-5
Control Operation Guidelines	9-6
Electrical System	9-6
DC System	9-7
Propellers	9-8
Propeller Selection and Replacement Guidelines	9-9
Dual-Prop Drives	9-9
Gauges / Instruments	9-10
Multi-Gauges	9-10
Tachometer	9-10
Speedometer	9-11
Fuel Level Gauge	9-11
Engine Water Pressure Gauge	9-11
Power Trim / Tilt Gauge	9-12
Voltmeter	9-12
Engine Water Temperature Gauge	9-12
Engine Hour Meter	9-13
Oil Level Gauge (Outboard Engine Oil Injection Optional)	9-13
Water Depth Gauge	9-13



TABLE OF CONTENTS

Compass	9-13
Engine Warning Alarm System	9-13
Helm and Control Switches	9-14
Ignition Switch	9-14
Battery Switch	9-14
Engine Emergency Stop Switch and Lanyard	9-15
Neutral Start Safety Switch (Start-in-Gear Prevention)	9-15
Horn Switch	9-16
Boarding and Courtesy Light Switches	9-16
Power Trim / Tilt Switch	9-16
Navigation Lights Switch	9-16
Bilge Pump Switch	9-16
Bilge Pump System	9-17
Boat Ventilation System	9-17
Raw Water System	9-18
Livewells	9-19
Manual Livewell	9-20
Recirculating Livewell	9-21
Remote Livewell	9-22
Livewell Controls and Operation	9-22
Electric Trolling Motor Systems	9-23
Trolling Motor Batteries	9-23
Trolling Motor Control Panel	9-24
Fish Locators, Graphs and Depth Indicators	9-24
Fishing Seats	9-24
General Care and Maintenance	10-1
Engine	10-1
Fuel System	10-1
Electrical System	10-2
Batteries	10-2
Circuit Breakers and Fuses	10-4
Galvanic Corrosion	10-6
Saltwater Corrosion	10-6
Sacrificial Anodes	10-7
Steering System	10-8

TABLE OF CONTENTS



Corrosion Protection	10-10
Hardware, Fasteners and Fittings	10-10
Stainless Steel and Chrome Hardware	10-10
Aluminum Hardware	10-10
General Maintenance and Cleaning	10-11
Marine Growth	10-11
Cleaning	10-11
Hull	10-12
Upholstery	10-12
Canvas Covers and Bimini Tops	10-13
Carpet	10-14
Windshield	10-14
Window Channels	10-14
Teak	10-14
Bilge	10-15
Bilge Pump	10-16
Safety Equipment	10-16
General Boating Equipment	10-16
Trailer	10-17
Winterization and Storage	11-1
Winterization and Storage Preparation	11-1
Storing on a Cradle or Blocks	11-2
Storing on a Trailer	11-3
Recommissioning After Storage	11-3
Lifting	11-5
Troubleshooting	12-1
Glossary of Nautical Terms	13-1
Warranty	W-1
Index	I-1



TABLE OF CONTENTS

This Page Intentionally Left Blank

Section 1

INTRODUCTION

CONGRATULATIONS

Congratulations and welcome aboard! To ensure each boating experience is a safe and enjoyable one, please read all the literature provided with your newly purchased boat carefully before operating the boat or any equipment.

Please keep this manual on board for future reference and pass all information along to the new owner if you ever decide to sell the boat.

ABOUT THIS MANUAL

This manual has been written as a general guide to safe operating practices, boating regulations and maintenance techniques for recreational boating. If this is your first time owning or operating a boat, it is recommended that you contact the boat dealer or local boating agency to find out how to enroll in a boater safety course prior to operating the boat.

This manual is not intended to be used as a replacement for specific information and procedures covered in manuals provided by the manufacturer of the engine, accessories and other major equipment.

Because we are constantly working toward product improvement, this manual is intended to be a general guide only. The illustrations used in this manual may not match the equipment on the boat; they are intended only as general reference views.



ABOUT YOUR NEW BOAT

BOAT TERMINOLOGY

It is important that you understand, learn and use appropriate and common nautical terminology while boating to ensure operator safety and the safety of others.

See the Glossary of Nautical Terms section of this manual for additional boating terminology.

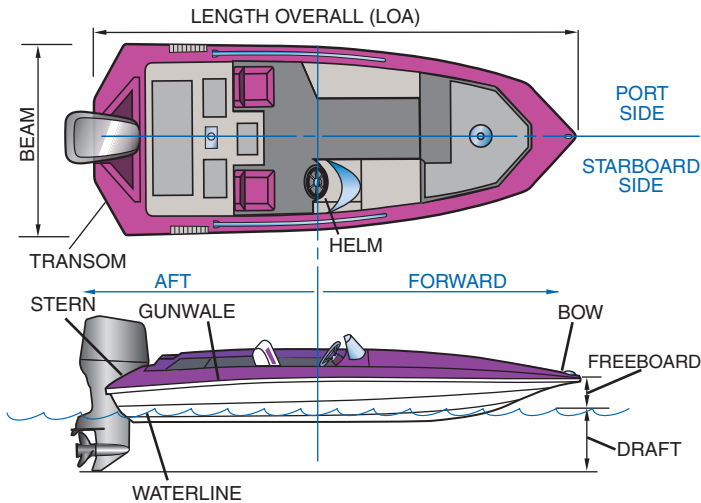

KC-0071C-A

HULL IDENTIFICATION, CAPACITY AND SAFETY PLATES

Hull Identification Number

The hull identification number (HIN) is usually located near the upper starboard corner of the transom on the outside of the boat. In some instances, the HIN may be located in an alternate location as determined by the manufacturer (e.g., a pontoon HIN may be located on the aft crossmember approximately 1 foot (0.3 meters) from the starboard hull attachment). The HIN must be clearly visible and may not be removed, altered or tampered with in any way as regulated by federal law.



In case of collision, theft or damage, report these numbers to the local authorities, the insurance agent and the dealer.

Safeguard information about the boat by recording the HIN and model of the boat, and model and serial numbers of the engine and accessories on the Boat Information Form in this manual.

U.S. Coast Guard Safety Standards Compliance Plate

All power boats less than 20 feet (6 meters) must have a manufacturer's compliance plate clearly indicating that the boat is in compliance with the U.S. Coast Guard (USCG) safety standards and the effective date of the compliance. The compliance plate may be combined onto one plate showing both the capacity plate and compliance information by the manufacturer.

As a division of the U.S. Department of Homeland Security, the USCG is the ultimate authority on U.S. waters. The USCG has the right to board any boat for any reason at any time. Failure to obey an order from the USCG can result in a fine, confiscation, imprisonment and even being fired upon in certain areas or conditions.

Certification Standards

The boat was built to meet federal USCG requirements and *may* be certified to more stringent American Boat & Yacht Council (ABYC) standards for the fuel, electrical, ventilation, flotation, horn, identification, capacity, placards and labels, powering, start-in-gear protection, navigation lights, backfire flame control and in most cases, fire extinguishers.

The boat owner is responsible for other USCG-required safety items, which can vary depending on the size of the boat as follows:

- Fire Extinguishers
- Life Jackets
- Visual Distress Signals

The boat manufacturer or dealer may provide some required safety items. Your boat *may not* be certified to ABYC standards; check the capacity plate for more information.



The person/load capacity is determined by the USCG. The capacity plate is usually located within clear visibility of the boat operator or helm area. The capacity plate indicates limits for loading the boat, which are enforceable by law. Never exceed the “U.S. Coast Guard Maximum Capacities” indicated on the capacity plate.

Boats in the National Marine Manufacturers Association (NMMA) Certification program up to 26 feet (7.9 meters), or a pontoon boat of any length, are certified to ABYC standards, have the USCG maximum rated load capacity on the certification plate and may contain EPA and/or CARB emission information. Do not exceed maximum person or weight capacities.



KCB-0008

REFERENCES AND CONTACT INFORMATION

Use the following list of publications and organizations for reference and contact information concerning safe boating, navigational rules and other boating topics.

Publications

- Bottomley, Tom. *Boatman's Handbook*. Hearst Marine Book. Morrow
- Brotherton, Miner. *Twelve Volt Bible*. Seven Seas
- Calder, Nigel. *Boatowner's Mechanical and Electrical Manual*. McGraw-Hill Education
- Chapman, Charles F. and Maloney, E.S. *Chapman's Piloting, Seamanship and Small Boat Handling*. Hearst Marine Book. Morrow
- Hinz, Earl. *The Complete Book of Anchoring and Mooring*. Cornell Maritime Press
- National Fire Protection Association. *NFPA 302 Fire Protection Standard for Pleasure and Commercial Motor Craft*. National Fire Protection Association
- United States Coast Guard. *Navigational Rules for U.S. Waterways*. Visit <https://www.navcen.uscg.gov/> to view or download this publication.
- United States Coast Guard Auxiliary. *Boating Skills and Seamanship Thirteenth Edition*. United States Coast Guard
- Whiting, John and Bottomley, Tom. *Chapman's Log and Owner's Manual*. Hearst Marine Book



Organizations

American Boat & Yacht Council

Boat building standards.
<http://abycinc.org>

American Red Cross

A resource for first aid training, emergency supplies and preparedness.
<http://www.redcross.org> or consult the local telephone directory

Boat Owners Association of The United States

Organization of recreational boaters offering marine services, education and protecting boater's rights.
<http://www.boatus.com/>

BoatU.S. Foundation for Boating Safety Hotline

Training and education outreach directly to boaters.
<http://www.boatus.org/>
Phone: 800-245-2628

National Association of State Boating Law Administrators

Boat safety training and education resources.
<http://www.nasbla.org>

National Marine Manufacturers Association

Boat, marine engine and accessory manufacturer trade association.
<http://www.nmma.org>

National Oceanic and Atmospheric Administration's National Weather Service

Nautical charting, weather, fishery, ocean and climate resources.
<http://www.noaa.gov>

National Safe Boating Council, Inc.

<http://www.safeboatingcouncil.org>

Sea Tow Services International, Inc.

Organization of recreational boaters offering in-water services, education and emergency assistance.
<http://www.seatow.com>
Toll free: 800-473-2869

***U.S. Coast Guard***

<http://www.uscgboating.org> (To contact the U.S. Coast Guard for an emergency while on the water, always use the onboard VHF-FM radio channel 16. Use cell phones only as a secondary means of communication. Call 9-1-1 to reach rescue personnel.)

U.S. Coast Guard Auxiliary

Information on boating safety classes and vessel safety checks.
<http://nws.cgaux.org>; Phone: 877-875-6296

U.S. Coast Guard Navigation Center (NAVCEN)

USCG navigation information.
<https://www.navcen.uscg.gov>

U.S. Coast Guard Office of Boating Safety

USCG resources for recreational boaters.
<http://www.uscgboating.org>

U.S. Coast Guard's America's Waterway Watch Program

<http://www.americaswaterwaywatch.uscg.mil> (A program for recreational boaters to assist the U.S. Department of Homeland Security in reporting suspicious activity on U.S. waterways); Phone: 877-249-2824

U.S. Government Publishing Office

<http://www.gpo.gov>
(For information and documentation on FCC rules and regulations and Skippers Course information, and other government, marine and nautical related documents)

U.S. Power Squadrons

Boating courses and knowledge resources.
<http://www.usps.org>; Phone: 888-367-8777



BOAT INFORMATION FORM

BOAT	
Boat Manufacturer:	
Hull Colors:	
Weight:	
Length:	
Draft:	
Beam:	
Vertical Clearance:	
Dealer:	
Dealer Representative:	
Dealer Phone:	
Boat Model:	
Hull ID Number (HIN):	
Registration Number:	
Registration State:	
Purchase Date:	
Delivery Date:	
Warranty Expiration Date:	
Manufacturer Representative:	
Manufacturer Phone:	
ENGINE, DRIVE AND PROPELLER	
Engine Make:	
Engine Model Number:	
Engine Serial Number:	
Ignition Key Number:	
Drive Make:	
Drive Model Number:	
Drive Serial Number:	
Propeller	Make/Type:
	Size/Material:
	Part Number:

**SYSTEMS****Fuel Filter Part Number:****Battery Make:****Battery Size:****TRAILER****Trailer** **Make:****Model Number:****Serial Number:****GVWR:****Tire Size:****ACCESSORIES****Manufacturer:****Model:****Serial Number:****Manufacturer:****Model:****Serial Number:****Manufacturer:****Model:****Serial Number:****Manufacturer:****Model:****Serial Number:****Manufacturer:****Model:****Serial Number:**



TILLER SPECIFICATIONS

1750 TILLER	
Length	17'5" (5.31 m)
LOA on Trailer	19'7" (5.97 m)
Beam	8'0" (2.44 m)
Draft (Drive Down)	29" (73.6 cm)
Draft (Drive Up)	13" (33 cm)
Weight	1,800 lbs (816 kg)
Fuel Capacity	22 gal (83.27 L)
Weight Capacity	1,300 lbs (590 kg)
Maximum Power	90 HP
1850 TILLER	
Length	18'6" (5.64 m)
LOA on Trailer	21'0" (6.4 m)
Beam	8'6" (2.59 m)
Draft (Drive Down)	32" (81.28 cm)
Draft (Drive Up)	16" (40.64 cm)
Weight	2,271 lbs (1,030 kg)
Fuel Capacity	36 gal (136 L)
Weight Capacity	1,650 lbs (748 kg)
Maximum Power	90 HP
2020 TILLER	
Length	20'8" (6.33 m)
LOA on Trailer	22'4" (6.8 m)
Beam	8'6" (2.59 m)
Draft (Drive Down)	30" (76.2 cm)
Draft (Drive Up)	14" (35.56 cm)
Weight	2,770 lbs (1,256 kg)
Fuel Capacity	53 gal (200.62 L)
Weight Capacity	1,750 lbs (794 kg)
Maximum Power	200 HP

**DUAL CONSOLE SPECIFICATIONS**

1750 DC	
Length	17'5" (5.31 m)
LOA on Trailer	19'7" (5.97 m)
Beam	8'0" (2.44 m)
Draft (Drive Down)	29" (73.6 cm)
Draft (Drive Up)	13" (33 cm)
Weight	2,030 lbs (921 kg)
Fuel Capacity	22 gal (83.27 L)
Weight Capacity	1,500 lbs (680 kg)
Maximum Power	150 HP
1850 DC	
Length	18'6" (5.64 m)
LOA on Trailer	21'0" (6.4 m)
Beam	8'6" (2.59 m)
Draft (Drive Down)	33" (83.82 cm)
Draft (Drive Up)	17" (43.18 cm)
Weight	2,400 lbs (1,089 kg)
Fuel Capacity	36 gal (136 L)
Weight Capacity	1,750 lbs (794 kg)
Maximum Power	200 HP
2020 DC	
Length	20'8" (6.33 m)
LOA on Trailer	22'4" (6.8 m)
Beam	8'6" (2.59 m)
Draft (Drive Down)	30" (76.2 cm)
Draft (Drive Up)	14" (35.56 cm)
Weight	2,550 lbs (1,157 kg)
Fuel Capacity	53 gal (200.62 L)
Weight Capacity	2,000 lbs (907 kg)
Maximum Power	300 HP

Section 2

SAFETY

The popularity of boating and other water sports has undergone an explosion of growth in the past few years, making safety an important issue for everyone who shares in the use of the waterways.

⚠ WARNING *Operation Hazard: Read and understand this Basic Boating and Safety Manual, the Engine Operator's Manual and all manufacturer-supplied information regarding the operation of equipment. The boat operator must understand all safety information responsibilities, regulations, controls and operating instructions before attempting to operate the boat. Improper operation could result in death or serious injury.*

The safety content and precautions listed in this manual and on the boat are not all-inclusive. If a procedure, method, tool or part is not specifically recommended, the operator must feel confident that it is safe for them and others, and that the boat will not be damaged or become unsafe as a result of the operator's decision.

REMEMBER – ALWAYS ASSESS EACH SITUATION AND USE SOUND JUDGMENT!

The boat operator is responsible for their own safety, as well as that of passengers and other boaters.

GOOD BOATING PRACTICES

Boating-related accidents are generally caused by the operator's failure to follow basic safety rules or written precautions. Most accidents can be avoided if the operator is completely familiar with the boat, its operation and the navigational rules of the road and can recognize potentially hazardous situations.

In addition to everyday safety, failure to observe safety recommendations may result in severe personal injury or death to the operator or to others. Use caution and sound judgment when operating the boat. Do not take unnecessary chances! Failure to adhere to these warnings could result in death or severe injury to the operator and/or others.



Read this entire manual and be aware of other specific safety guidelines not listed in this manual. Seek additional safety information from the USCG and state and local authorities. In addition to specific safety statements noted in this manual, a general list of safety guidelines and recommendations is listed below:

- The boat must comply with USCG safety equipment regulations.
- Before each outing, check all safety equipment such as fire extinguishers, life jackets, flares, distress flags, flashlights and engine emergency stop switch. Make sure they are operable, in good condition, readily visible and easily accessed.
- Onboard equipment must always conform to the governing federal, state and local regulations.
- Never allow any type of spark or open flame on board. It may result in fire or explosion.
- Take the keys/FOBs when leaving the boat to keep untrained and unauthorized persons from operating the boat.
- Know how to react correctly to adverse weather conditions, have good navigation skills and follow navigational rules as defined by USCG, state and local regulations.
- Check local weather reports before casting off. Do not leave the dock area when strong winds and electrical storms are in the area or predicted to be in the area.
- Seek shelter from open water if lightning is an imminent threat.
- Tell someone of the travel plans before departing.
- Know the weight capacity of the boat. Never overload the boat.
- Never operate the boat while under the influence of drugs or alcohol.
- Look before turning the boat. The boater is obligated to maintain a course and speed unless it is safe to alter course and speed. Look before turning.
- Operators must read and understand all operating manuals supplied with the boat before operation.
- Whenever planning an outing, make sure that at least one passenger is familiar with the operation and safety aspects of the boat in case of emergency.
- Passengers should never sit in front of the operator; always avoid obstructing the operator's view.
- Show all passengers the location of emergency equipment and explain how to use it.
- Never allow passengers to drag their feet or hands in the water, or sit on the bow, bow pulpit, deck or gunwale while the engine is running.
- Never use or hold on to the boarding platform while the engine is running.



- Never stand or allow passengers to stand in the boat or sit on the transom, seatbacks, engine cover or sides of the boat while the engine is running. The operator or others may be thrown from the boat.
- Children and nonswimmers must wear a life jacket at all times.
- Never leave children in the boat without adult supervision.
- Improper operation of the boat is extremely dangerous.
- Securely attach the engine emergency stop switch lanyard to a part of your clothing, such as a belt loop, when operating the boat.
- Operate slowly in congested areas such as marinas and mooring areas.
- The bow may be slippery. Do not go forward while the engine is running.
- Slow down when crossing waves or wake in order to minimize the impact on passengers and the boat.
- Never replace the boat's marine parts with automotive parts (if applicable).
- Never remove or modify any components of the fuel system. Always have qualified personnel perform fuel system maintenance. Tampering with fuel components may cause a hazardous condition.
- Avoid contact with engine exhaust gases—engine exhaust contains carbon monoxide.
- Never operate the engine in a confined space.
- Never go under the boat cover with the engine running or shortly after the engine has been running.
- Allow adequate ventilation with fresh air before entering any enclosed areas.
- Watch for other boats, swimmers and obstructions in the water. Stay away from other boats and personal watercraft (PWCs).
- Never swim near a boat when the engine is running. Even if the boat is in the NEUTRAL position, the propeller may still be turning and carbon monoxide may be present.
- Never dive from the boat without being absolutely sure of the depth of the water; severe injury or death may occur from striking the bottom or submerged objects.
- Never wrap ski lines or mooring lines around any body part. You could become entangled in the line if you fall overboard while the boat is moving.
- Keep track of ski lines and dock lines so they do not become entangled in the propeller.
- Have an experienced operator at the helm and always have at least three people present for safe towing—one to drive, one to observe, and one to ski or ride.



SAFETY DECALS AND STATEMENTS

SAFETY DECALS

The boat is affixed with various hazard and safety decals at the time of manufacture. These decals appear in specific locations on the boat and on equipment where safety is of particular concern. All operators of the boat must read and understand all hazard and safety decals and advise all passengers on the safety concerns and proper practices. Hazard and safety decals must remain legible. If the operator suspects a decal is missing or damaged they should contact the dealer for immediate replacement.

Decals Placed at Fuel Fill and Starboard Transom

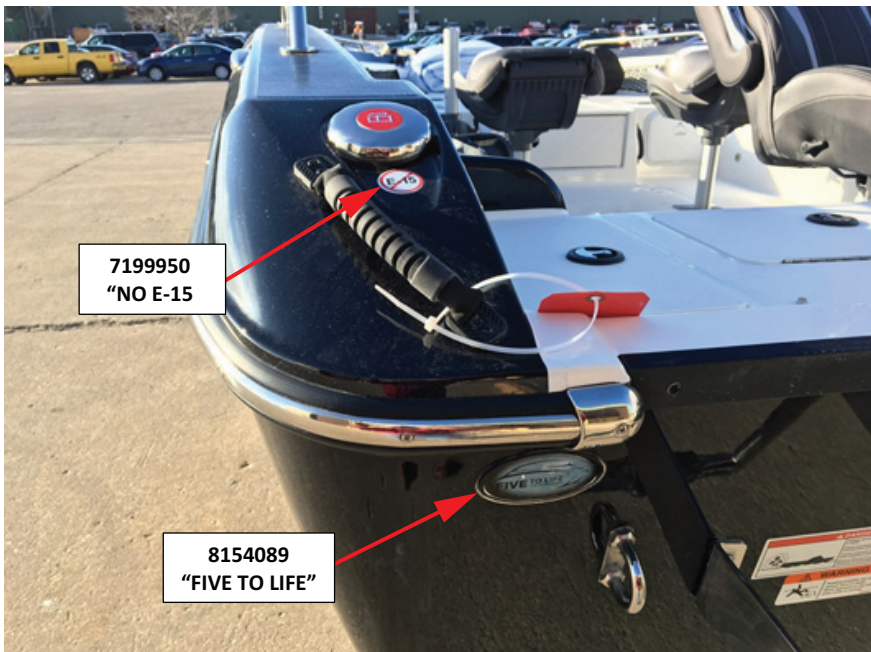

LAR-0027



Decals Placed on Transom Near Swim Ladder



LAR-0028



SECTION

2

SAFETY

Decals Placed at Forward Side of Engine Bay

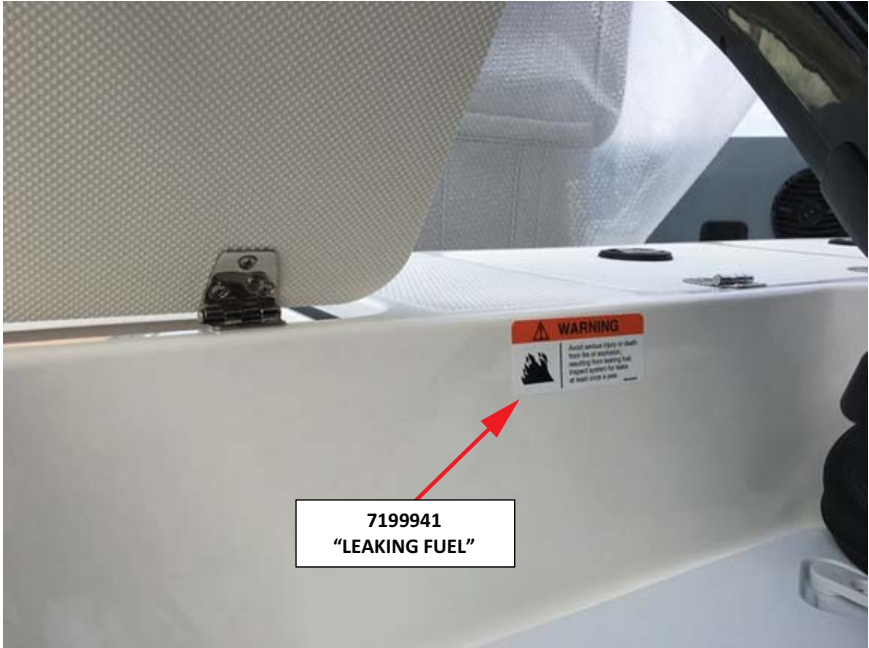

LAR-0029



Tiller Decal Placement, at Stern, Near Control Area



LAR-0030



Dual Console Decal Placement, at Helm

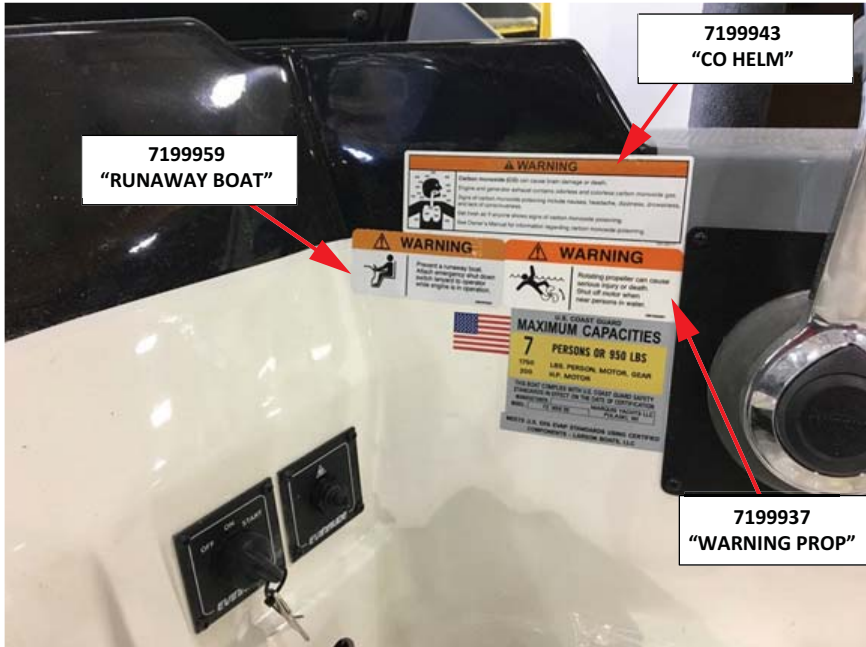

LAR-0031



SAFETY STATEMENTS

There is no substitute for sound judgment and careful practices. Improper practices or carelessness can cause burns, cuts, mutilation, asphyxiation, other bodily injury or death. This information contains general safety precautions and guidelines that must be followed to reduce risk to personal safety. Special safety precautions are listed in specific procedures. Read and understand all of the safety precautions before operation or performing repairs or maintenance.



NOTE — This safety alert symbol appears with most safety statements. It means attention, become alert, your safety is involved! Please read and abide by the message that follows the safety alert symbol.



DANGER

Indicates a hazardous situation that, if not avoided, will result in death or serious injury.



WARNING

Indicates a hazardous situation that, if not avoided, could result in death or serious injury.



CAUTION

Indicates a hazardous situation that, if not avoided, could result in minor or moderate injury.

NOTICE

Indicates a situation that can cause damage to the boat and accessories and/or the environment, or cause the equipment to operate improperly.



SAFETY PRECAUTIONS



DANGER

The safety messages that follow have **DANGER** level hazards. These safety messages describe hazardous situations that, if not avoided, will result in death or serious injury.



Training Hazard: Do not permit anyone to launch, operate or retrieve the boat without proper training.

- Read and understand this Basic Boating and Safety manual and all manufacturer-supplied information before operating or servicing the boat to ensure that you follow safe operating practices and maintenance procedures.
- Safety signs and decals are additional reminders for safe operating and maintenance techniques.
- See the boat dealer for additional training.



Exhaust Hazard: Carbon monoxide (CO) is a colorless and odorless gas produced by all engines, fuel-burning appliances and any material that contains carbon and is burned. Direct or prolonged exposure to carbon monoxide will cause brain damage or death.



Electrocution Hazard: Docks and other boats nearby can carry sources of electricity. Faulty wiring or the use of damaged electrical cords and other devices not approved as “shore or marine rated” can cause the surrounding water source to become energized from electricity leakage. Never enter the water or swim in a marina.



WARNING

The safety messages that follow have **WARNING** level hazards. These safety messages describe hazardous situations that, if not avoided, could result in death or serious injury.



Fire/Explosion Hazard: Gasoline is extremely flammable and highly explosive under certain conditions.

- Compartments for fuel, flammable liquids or gases must be properly ventilated to prevent explosive vapors from accumulating. Most vapors are heavier than air. If not in a vapor-tight locker vented overboard, vapors will accumulate in the bilge, posing a fire and explosion hazard.
- Inspect fuel system for leaks at least once a year.



Fire/Explosion Hazard: Hydrogen gases produced by a lead-acid battery while it is charging, or the engine is running, can cause an explosion and/or a fire.

- Always wear personal protective equipment when working on or around batteries.
- Keep the area around the battery well-ventilated.
- Do not smoke or bring an open flame or any other form of ignition near a battery.
- Do not check for a dead battery by placing a metal object between the battery posts. Sparks could cause an explosion.
- Do not place your head directly above a battery when making or breaking electrical connections.
- Always charge the battery outside of the boat.
- Do not use a battery booster to start the engine.



Sever Hazard: Make sure nobody is near the propeller before starting the engine(s).

- Do not allow swimmers to approach or use the ladder when the engine is running.
- The operator should walk to the stern and check the water for people near the propeller, as people in the water may not always be noticeable from the helm.
- Turn off the engine(s) before allowing people to board or exit the boat. The propeller may continue rotating even when the engine is idling or in NEUTRAL.
- Show passengers the location of the propeller and teach them to keep their distance from it at all times, even when the propeller is not in motion.
- Show passengers the propeller warning labels around the boat and discuss propeller dangers.
- Be particularly alert when boating in high-traffic areas and never operate in swimming zones.
- Exercise caution when operating near boats that are towing skiers and tubers.
- Never allow passengers to sit in areas where they could fall overboard, including the bow, gunwale, transom, seat backs, or other locations.



- **Carefully watch children aboard the boat at all times.**
- **Instruct passengers on the rules for using the swim platform, boarding ladders and seats. If possible, instruct them to stay seated at all times while the boat is underway.**



Man Overboard Hazard: Always remain seated in the boat manufacturer's designated seating arrangement, use handholds and never block the view of the boat operator while underway. The boat's bow, gunwale, transom platform and seat backs are not intended for use while underway.

- **If someone falls overboard, slowly turn the boat around while keeping an eye on the victim. Ask a passenger to help monitor the victim. Always STOP THE ENGINE before rescuing a victim from the water.**
- **Never put the engine in REVERSE to retrieve a person from the water. Slowly circle back to the person again if necessary.**



Entanglement Hazard: Rotating or moving parts can entangle or sever body parts.

- **Do not wear jewelry, unbuttoned cuffs, ties or loose-fitting clothing.**
- **Tie long hair back when working near moving or rotating parts such as the flywheel or propeller shaft.**
- **Keep hands, feet and tools away from all moving parts.**
- **Keep all guards in place when the engine is operating.**
- **Use caution when working with ski or mooring lines so they do not become entangled with the propeller.**



Exposure Hazard: Wear personal protective equipment, including appropriate clothing, gloves, work shoes, eye and hearing protection, as required by the current task.



Control Hazard: Do not operate the boat while you are under the influence of alcohol or drugs or if feeling ill.

**CAUTION**

The safety messages that follow have CAUTION level hazards. These safety messages describe hazardous situations that, if not avoided, could result in minor or moderate injury.



Slip/Trip Hazard: Keep the boat free of water, oil, mud and other foreign matter. Do not wax deck and swim platform surfaces. Remove anything that creates slippery areas around the boat.

NOTICE

The safety messages that follow have NOTICE level hazards. These messages are used to indicate a situation that can cause damage to the boat and accessories and/or the environment, or cause the equipment to operate improperly.

- *Unapproved modifications to the boat or systems may impair the boat's safety and performance characteristics and shorten the boat's life. Any alterations to the boat may void its warranty. Always consult the boat manufacturer before making modifications or adding equipment.*
- *ALWAYS be environmentally responsible. Follow the guidelines of the EPA or other governmental agencies for the proper disposal of hazardous materials such as engine oil and fuel. Consult the local authorities or reclamation facility.*



CARBON MONOXIDE (CO)



DANGER

Exhaust Hazard:

CO gas is colorless, odorless and extremely dangerous. All engines and fuel-burning appliances produce CO as exhaust. Direct and prolonged exposure to CO will cause brain damage or death. Always avoid exposing your passengers or yourself to CO.

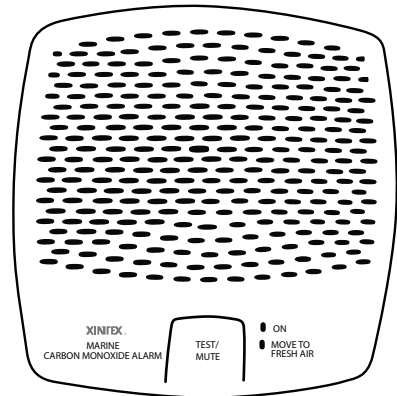

KC-0387-A

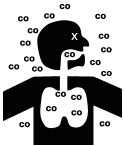

Even with the best boat design and construction, plus the utmost care in inspection, operation and maintenance, hazardous levels of CO may still be present in accommodation areas under certain conditions. To reduce CO accumulation, always provide adequate ventilation in the boat interior by opening the deck hatches, windows or canvas.

Do not confuse carbon monoxide poisoning with seasickness, intoxication or heat stress. If someone complains of irritated eyes, headache, nausea, weakness, dizziness or drowsiness, or you suspect carbon monoxide poisoning, immediately move the person to fresh air, investigate the cause and take corrective action. Seek medical attention if necessary.

Always use a CO detector in confined areas where there is a possibility of CO buildup, such as enclosed canvas, sleeping quarters, galleys and head compartments. Regularly check the condition of the CO detector for proper operation.

Test the carbon monoxide detector operation before each trip, at least once a week and after the boat has been in storage. Also have the CO detectors professionally tested at regular intervals. Most CO detectors are required to be replaced every 5 years – see the OEM manual.



Potential Causes of CO Poisoning While Underway

Blockage of boat exhaust by obstruction

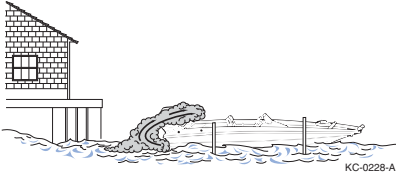

KC-0228-A

Exhaust from other vessels in confined areas



KC-0231-A

Operating at a high bow angle



KC-0230-A

Operating at slow speed or while idling



KC-0232-A

Exhaust traveling along obstruction



KC-0229-A

Always ensure adequate fresh air ventilation through the boat when underway.



KC-0310-A

KC-0297-B



REQUIRED BOATING SAFETY EQUIPMENT AND REGULATIONS

**U.S. Coast Guard Minimum Onboard Personal Safety Equipment Required
(Your boat may be equipped with one or more requirements by the manufacturer.)**

	LESS THAN 16 FT (4.9 M)	CLASS 1: 16 TO LESS THAN 26 FT (4.9 TO LESS THAN 7.9 M)	CLASS 2: 26 TO LESS THAN 40 FT (7.9 TO LESS THAN 12.2 M)	CLASS 3: 40 TO 65 FT (12.2 TO 19.8 M)
LIFE JACKETS AND PERSONAL FLOTATION DEVICES (PFDs)	One U.S. Coast Guard-approved Type I, II, III or V wearable life jacket for each person on board	One U.S. Coast Guard-approved Type I, II, III or V wearable life jacket for each person on board and one throwable Type IV PFD device		
VISUAL DISTRESS SIGNALING DEVICES	One (1) electric distress light OR three (3) day and night combination red flares	One orange distress flag or one electric distress light OR three floating or handheld orange smoke signals and one electric distress light OR three day and night combination red flares, handheld, parachute or meteor type		
AUDIBLE SIGNALING DEVICES	A boat less than 39.4 ft (12 m) must have on board an efficient sound-producing device. (Example: hand or mouth whistle OR a compressed or powered air horn)		A boat less than 39.4 ft (12 m) must have on board an efficient sound-producing device. (Example: hand or mouth whistle OR a compressed or powered air horn) A boat 39.4 ft (12 m) but less than 65.6 ft (20 m) in length operating in inland waterways must carry a power whistle OR powered air horn AND a bell	
NAVIGATION LIGHTS	Regulations require that navigational lights be clearly lit and properly displayed at all times between sunset and sunrise and always when operating in reduced visibility while boating			



	LESS THAN 16 FT (4.9 M)	CLASS 1: 16 TO LESS THAN 26 FT (4.9 TO LESS THAN 7.9 M)	CLASS 2: 26 TO LESS THAN 40 FT (7.9 TO LESS THAN 12.2 M)	CLASS 3: 40 TO 65 FT (12.2 TO 19.8 M)
FIRE EXTINGUISHERS	<p>One B-I type (U.S. Coast Guard-approved)</p> <p>If the boat meets any one or more of the following conditions, the boat must carry one B-I type USCG-approved extinguisher on board:</p> <ul style="list-style-type: none"> • Inboard/sterndrive engine powered • Has closed compartments where portable fuel tanks can be stored • Has double bottom construction that has areas where air or gases can be open or trapped • Has an enclosed living space • Has compartments where flammable, combustible or explosive materials are stored • Has permanent fuel tanks installed • Boat is 26 ft (7.9 m) or more in length 		<p>One B-II OR two B-I type (USCG-approved) (A fixed extinguishing system is equal to one B-I.)</p>	<p>One B-II AND one B-I OR three B-I type (USCG-approved) (A fixed extinguishing system is equal to one B-I OR two B-II.)</p>



FIRE EXTINGUISHER

USCG-approved fire extinguishers are required on all Class I, II and III boats. Mount all handheld fire extinguishers in readily accessible areas away from the engine compartment and other combustible devices. All passengers must know the location and operating procedure of each extinguisher. Follow the manufacturer's instructions for proper use and operation of the fire extinguisher.

All fire extinguishers used on marine boats must be classified to extinguish type B fires (gasoline, oil or grease). The size and number of required fire extinguishers depend on the size of the boat. The two type B fire extinguishers commonly used are B-I and B-II. Type B fire extinguishers are classified by the different extinguishing compound amounts used in each.

Check the fire extinguisher condition and pressure gauge regularly, if not before every trip, to ensure that the fire extinguisher is in good operating condition and is fully charged. If the fire extinguisher is damaged or not properly pressurized, replace it.

See the U.S. Coast Guard Minimum Onboard Personal Safety Equipment Required section of this manual for specific onboard requirements.

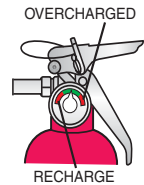

KC-0009C-B

ENGINE EMERGENCY STOP SWITCH AND LANYARD

The engine emergency stop switch is an extremely important safety precaution. Use the engine emergency stop switch when operating the boat's engine. This safety device prevents the boat from becoming a runaway if the operator is accidentally thrown from the seat or away from the helm.

Before turning on the boat's engine, secure the engine emergency stop switch lanyard to the operator. If the operator is thrown from the seat or moves too far from the helm, the lanyard will disconnect from the switch, activating the switch to turn off the engine.

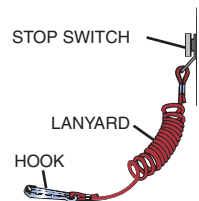

KCB-0003

**WARNING**

Control Hazard: Never remove or modify the engine emergency stop switch and/or lanyard.

- **Always check the switch for proper operation. With the engine running, pull the lanyard. If the engine does not stop, have the switch repaired before continuing to operate the boat. Never operate the boat if the engine emergency stop switch does not work.**
- **Attach the engine stop switch cord lanyard to a secure place on your clothing, your arm or leg while operating.**
- **Avoid accidentally pulling the cord lanyard during normal operation. Loss of engine power means loss of most steering control. Also, without engine power, the boat could slow rapidly. This could cause people and objects in the boat to be thrown forward.**
- **DO NOT attach the cord lanyard to clothing that could tear loose. DO NOT route the cord lanyard where it could become entangled, preventing it from functioning.**

LIFE JACKETS

Boaters enjoy the feel of sun and spray, so it's tempting to boat without wearing a life jacket, especially on nice days. However, the failure to wear life jackets is by far the number one cause of boating fatalities.

Modern life jackets are available in a wide variety of shapes, colors, sizes and technologies. Many are thin and flexible. Some are built right into fishing vests or hunter coats. Others are inflatable and as compact as a scarf or fanny pack until they hit water and automatically fill with air.

There's no excuse for not wearing a life jacket on the water. Boat dealers or marine stores are the best sources for guidance when selecting this most important piece of safety equipment.

Things to Know about Life Jackets:

- Certain life jackets are designed to keep the head above water and help you remain in a position that permits proper breathing.
- To meet USCG requirements, a boat must have a USCG-approved life jacket for each person aboard. Boats 16 feet and over must have at least one Type IV throwable device as well.
- All states have regulations regarding children wearing life jackets.
- Adult-sized life jackets will not work for children. Special life jackets for children are available. To work correctly, a life jacket must be worn, fit snugly and not allow the child's chin or ears to slip through.



- Life jackets can be equipped with whistles, strobe lights, handheld VHF radios and personal locator beacons.
- Life jackets are recommended for open water.
- Test life jackets for wear and buoyancy at least once each year. Discard waterlogged, faded or leaky jackets.
- Properly stow life jackets but make them easily accessible.
- A life jacket, especially a snug-fitting flotation coat or deck-suit style jacket, can help people survive in cold water.

Life Jackets Must Be:

- USCG-approved
- In good and serviceable condition
- Appropriately sized for the intended user
- The best life jacket is the one you will wear

Accessibility

- Wearable life jackets must be readily accessible.
- Boaters must be able to locate and put them on in a reasonable amount of time in an emergency.
- They should not be stowed in plastic bags, in locked or closed compartments or have other gear stowed on top of them.
- Throwable devices must be immediately available for use in emergency situations.
- Though not required, a life jacket should be worn at all times when the boat is underway. A life jacket can save a boater's life, but only if the boater wears it. Set the example and wear it whenever near the water.

Child Life Jacket Requirements

Some states require that children wear life jackets at all times; check with the state boating safety authorities.

- Applies to children of specific ages
- Applies to certain sizes of boats
- Applies to specific boating operations

Child life jacket approvals are based on the child's weight. Check the "user weight" on the label, or the approval statement that will read something like "Approved for use on recreational boats and uninspected commercial boats not carrying passengers for hire, by persons weighing XX lbs." They can be marked "less than 30," "30 to 50," "less than 50," or "50 to 90."



Since children grow quickly, many boat launches now feature free use of children's life jackets in several different weight categories.

Life Jacket Requirements for Certain Boating Activities Under State Laws

The USCG recommends, and many states require, wearing USCG-approved life jackets:

- For waterskiing and other towed/surf activities, use a life jacket designed for waterskiing. **It is illegal in many states to participate in towed water sports without a USCG-approved life jacket. Be aware that some specialized water sports vests are NOT USCG-approved and should be worn in addition to a USCG-approved life jacket.**
- While operating personal watercraft (PWC) use a life jacket marked for PWC or waterskiing use.

Check with the state boating safety authorities. Other rules may apply if boating in an area under the jurisdiction of the Army Corps of Engineers or a federal, state or local park authority. Special local rules are usually posted at the boat launch.

Type I Life Jacket

This life jacket is designed so that the person wearing it turns to a face-up position when conscious or unconscious. Type I life jackets are the most buoyant and are effective on all waters, especially when rescue is delayed or flotation time is extended.



TYPE I

KC-0003C-A

Type II Life Jacket

This life jacket is recommended for use in calm water near shore on most inland waters where quick rescue is likely. A Type II life jacket is similar to a Type I life jacket, but it is not as buoyant or effective in turning the wearer to a face-up position.



TYPE II

KC-0006C-A

Type III Life Jacket

This life jacket is designed for personal buoyancy when the wearer is alert and conscious. Type III life jackets require users to turn themselves to a face-up position. Type III life jackets are recommended in most inland water applications where quick rescue is likely or when used in the presence of other people.



TYPE III

KC-0004C-A



Type IV Personal Flotation Device

These PFDs are designed to be thrown to a person in the water who can grab and hold it while being rescued. Never wear a Type IV PFD.

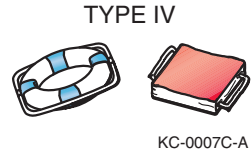

Type V Life Jacket

This life jacket is designed for special activities and may be worn instead of a Type I, II or III life jacket if used in accordance with the approval conditions on the label. If a Type V life jacket is part of the minimum onboard life jacket requirements and if it has a label that indicates “required to be worn,” it must be worn at all times. Otherwise one additional Type I, II or III life jacket must be on board to satisfy the minimum life jacket requirements. Some Type V life jackets provide increased protection against hypothermia.





VISUAL DISTRESS SIGNALING DEVICES

Boats less than 16 feet (4.9 meters) must have USCG-approved visual distress signals (VDS) on board when operating between sunrise and sunset in coastal waters, including ocean bays, gulfs and sounds, as well as the Great Lakes, seas, bays and river mouths that are 2 or more miles wide and only to the point proceeding inland where the water narrows to less than 2 miles. Visit the U.S. Coast Guard website for additional information on specific VDS requirements for the boat.

Ensure all passengers on board understand how to operate all VDS. Keep VDS in a readily accessible area and within immediate reach at all times when boating.

VISUAL DISTRESS SIGNALS

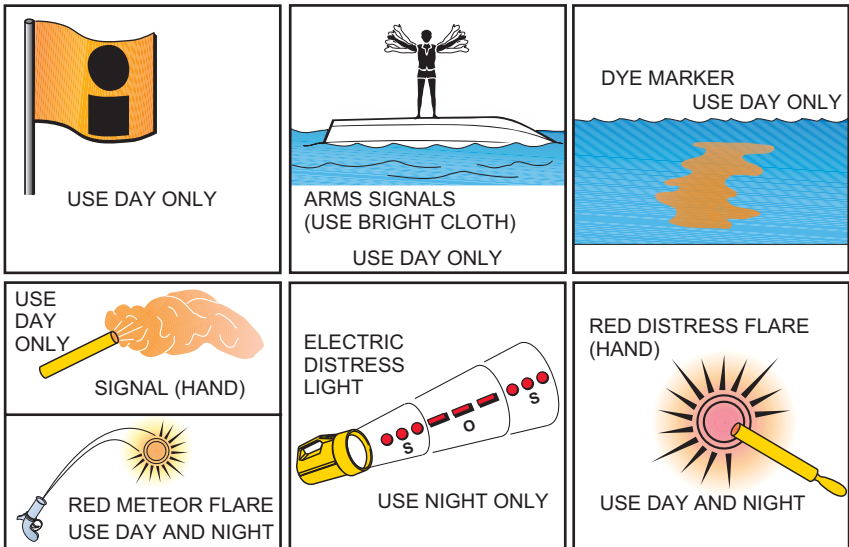

KC-0008C-B



Regulations prohibit using pyrotechnic VDS or any VDS in non-emergency situations.

VDS must be:

- USCG-approved
- In proper operating condition
- Safely stowed and readily available
- Within the clearly marked expiration date stamp on the device (where applicable)

Types of VDS vary by emergency situation. VDS are classified as either pyrotechnic or non-pyrotechnic.

NOTE — Some pyrotechnics may be restricted on certain bodies of water. Check with local authorities, or visit the National Association of State Boating Law Administrators (NASBLA) website: <http://www.nasbla.org> or the U.S. Coast Guard website: <http://www.uscg.mil> for additional information.

See the U.S. Coast Guard Minimum Onboard Personal Safety Equipment Required section of this manual for specific onboard requirements.

AUDIBLE SIGNALING DEVICES

Audible (sound) signals are required to be on board all boats to alert other boats of your presence. A boat less than 39.4 feet (12 meters) must always have an efficient sound-producing device on board (Example: hand or mouth whistle, or a compressed or powered air horn).

A boat at least 39.4 feet (12 meters) but less than 65.6 feet (20 meters) operating in inland waterways must always have a power whistle or powered air horn and a bell on board.

All devices must be acceptable for use in marine environments, audible for 1/2 nautical mile and maintain a continuous four- to six-second sound duration. The diameter of the bell's mouth must be a minimum of 7.9 inches (20.0 centimeters).

Ensure all passengers understand how to operate all audible distress signaling devices on board. Keep these devices in a readily accessible area and within immediate reach at all times when boating.

See the U.S. Coast Guard Minimum Onboard Personal Safety Equipment Required section of this manual for specific onboard requirements and see the Navigational Lights and Night Operation section of this manual for usage information.



NAVIGATIONAL LIGHTS

Navigational lights are intended to alert other boats to your presence and course.

Regulations require that navigational lights be clearly lit and properly displayed at all times between sunset and sunrise, and always when operating in reduced visibility. The placement, shape and visibility requirements of navigational lights may vary depending on usage. Check with local authorities, or visit the NASBLA or U.S. Coast Guard website for additional information.

For additional information, see the Navigational Lights and Night Operation section of this manual.

UNAPPROVED LIGHTING

The navigational lighting required by the USCG from sunset to sunrise and in inclement weather is extremely important to boat navigation. The lighting rules are not only designed to indicate direction and right-of-way, but are also designed to prevent night blindness and confusion with navigational aid, emergency and shore-based lights.

NOTICE

Onboard accessory equipment equipped with red/green/blue LED lighting should never be used when underway. The blue LED should never be used and is banned in several states. Blue lights are for law enforcement only.

Installing supplemental lighting for “show” can be very dangerous, confusing, distracting and may be illegal. Some light colors may not be compliant with certain local ordinances. Blue lighting is reserved for marine authorities and is illegal to use on boats. The operator is responsible for knowing and complying with local laws and must be familiar with local marine lighting regulations before use, even with certain factory-installed lighting.

Never add lighting above the waterline. Avoid lighted accessories such as speakers or light rope. Switch off underwater lights when underway. Use only factory-installed, low-intensity courtesy lighting on the water.



SECTION
2

SAFETY

RECOMMENDED SAFETY EQUIPMENT

Carry and know how to use the following equipment in addition to the required equipment on board at all times as an extra safety precaution:

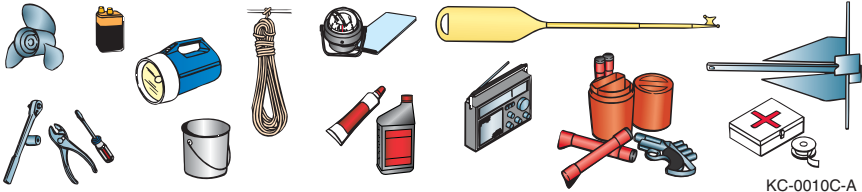

KC-0010C-A

Anchor and line with minimum 75 feet (23 meters) of line	GPS Global Positioning Device
Auxiliary starting battery	Insect repellent
Binoculars	Local charts and compass
Boat hook	Mirror, whistle and strobe light
Cellular phone with waterproof case and lanyard	Mooring lines
Compass	Navigational and interior light bulbs
Dock fenders	Oar/paddles
Dry bag	Propeller, nut and washer
Duct and electrical tape	Radio
Electrical wire	Sharp folding pocket knife
Emergency food and water	Solar USB charger and cable
Emergency Position Indicating Radio Beacon (EPIRB)	Spark plugs
Engine lubricant	Sunglasses and sun block
Extra drain plug	Thermal clothing
Extra transom plug	Throwable life ring
First aid kit and manual	Tool kit including propeller replacement tools
Flashlight and radio batteries	Tow line
Foul weather gear/clothing	VHF-FM/AM with weather band radio
Fuses	Waterproof flashlight



SAFETY AND TRAINING

There is a vast amount of recreational boating regulatory, safety and training information online, and much of it is free. This information covers laws, aids to navigation, rules of the road, hands-on boating safety courses, boat safety checks and much more for both novices and experienced boaters. Go to the following sites for more information:

- United States Coast Guard
www.uscgboating.org
- United States Power Squadron
www.usps.org
- BoatU.S. Foundation
www.boatus.org

SPECIAL NEEDS PASSENGERS

Keep these special precautions in mind when enjoying a day on the water with passengers who have special needs.

Toddlers

- Never leave children in the boat without adult supervision.
- Must weigh at least 18 pounds (8.2 kilograms), since that is the smallest children's life jacket approved by the USCG. Life jacket must be worn whenever near the water.
- Any device the child is placed in must have flotation.
- Child-proof the boat just like a home. Be sure all gates and compartments are closed and latched.
- Keep a close watch on the child's reaction to speed and conditions and react accordingly.
- Use a higher than normal SPF waterproof sunscreen and re-apply more often than usual.
- Find a safe area to put the child down without risk of going overboard. Allow the child to get accustomed to the surroundings before launching/leaving.
- Keep trips short, but let them have some fun if possible.



Pregnant Women

- Go boating during the day and in calm seas.
- Avoid sharp turns and slow down for large wakes.
- Drink more water than usual to stay hydrated.
- It is a good idea to stay seated in the accommodation deck area while underway.
- Stay close to the home port in the third trimester.

People with Handicaps and Elderly People

Depending on the disability, there are many marine-specialized options available to make boats safer and friendlier. Researching on the internet for your specific needs is the best way to start.

Pets

- Not all pets can swim; consider a life jacket.
- If playing fetch in the water, get a pet-friendly boarding ramp to make reboarding easier.
- Provide a shaded area and plenty of fresh drinking water.
- Consider foot protection for hot sand and boat surfaces.
- Allow the pet to get accustomed to the surroundings before launching/leaving. Keep the first outing short to allow the pet to get used to the boating environment.



SEATING

Keep your passengers seated in the designated occupant positions while underway. The boat's gunwale, transom platform and seat backs are not intended for use as seats while underway.

RECOMMENDED ON-PLANE SEATING LOCATIONS

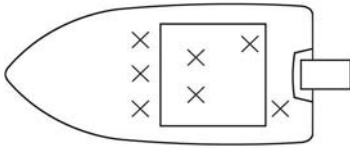

FX 1850 TL & FX 2020 TL

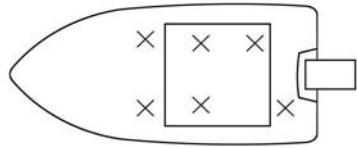

FX 1750 TL

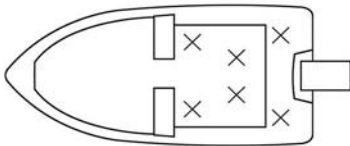

FX 1750 DC

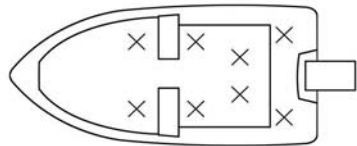

FX 1850 DC & FX 2020 DC

LAR-0032



VERY HIGH FREQUENCY (VHF) RADIO

The VHF radio is used to communicate with others on and off the water. VHF channel 16 (156.8 MHz) is designated as the international distress, safety and calling channel and is used to summon rescue services such as the USCG and to make initial contact with ports, marinas, bridges, locks and other boaters in the area. Use a VHF radio. The best way to clearly understand and deal with crossing, overtaking and meeting situations in open water is to communicate with the other boat on the radio.

The responder may then ask the caller for other information to help the caller. It is important to remain calm, speak slowly and be succinct. Short and concise communications are best no matter what the situation is.

Since VHF radios have limited distance line-of-sight (to the horizon) capabilities, it is important for all boaters receiving the distress call to attempt to render assistance until the rescue authorities arrive. The very nature of open water escalates the importance of any distress call. Boaters should always monitor (listening watch) channel 16 but never use it for casual communications. Assist others in distress if possible or monitor the situation until help has arrived.

In other communications, call the other party on channel 16 using your call sign. Bridges and locks will instruct boaters on what to do. Harbors, marinas and other boaters in the area will inform boaters to switch to a particular channel. Most VHF radios transmit in “simplex,” where communication can only take place in one direction at a time. For this reason, standard etiquette is to never interrupt a transmission and to wait 15-30 seconds before making a transmission. There are many channel options available for both commercial and non-commercial use.

NOTICE

The USCG is the lead agency for maritime search and rescue (SAR) in U.S. waters, but that mission is compromised every time the service receives a hoax distress call. Making a false distress call is a violation of federal law (14 U.S. Code § 88) and may result in up to six years in prison, a \$250,000 criminal fine, a \$5,000 civil fine, and reimbursing the U.S. Coast Guard for the cost of performing the search.

Using a VHF radio in foreign waters with a U.S.-registered boat may require a federal Ship Station License by law or treaty. Traveling to a foreign port (for example, Canada, Bahamas, British Virgin Islands and Mexico) requires a Ship Station License as well as a restricted radiotelephone operator permit (RR). Go to www.fcc.gov/wireless/bureau-divisions/mobility-division/ship-radio-stations for more information.

Read the VHF manufacturer’s information on the special features and use of the radio.



CRUISING LIMITATIONS

- Scan constantly for people, objects and other watercraft. Be alert for conditions that limit your visibility or block your vision of others.
- Operate defensively at safe speeds and keep a safe distance from people, objects and other watercraft.
- Do not follow directly behind other watercraft.
- Do not go near others to spray or splash them with water.
- Avoid sharp turns or other maneuvers that make it hard for others to avoid you or understand where you are going.
- Avoid areas with submerged objects or shallow water.
- Operate within your limits and avoid aggressive maneuvers to reduce the risk of loss of control, ejection and collision.
- This is a sophisticated boat—not a toy. Sharp turns or jumping waves or wakes can increase the risk of back/spinal injury (paralysis), facial injuries, broken legs, ankles and other bones. Do not jump waves or wakes.
- Do not operate the boat in rough water, bad weather or when visibility is poor; this may lead to an accident causing injury or death. Be alert to the possibility of bad weather. Take note of weather forecasts and the prevailing weather conditions before setting out in the boat.
- Leave a “float plan” with a responsible person on shore. Tell where you plan to go and when you plan to arrive, and provide a description of your boat. Advise this person if your plans change and also when you arrive to prevent false alarms. A sample float plan is included in this manual.

HAZARD INFORMATION

- Never start the engine or let it run for any length of time in an enclosed area. Exhaust fumes contain carbon monoxide, a colorless, odorless gas that may cause death within a short time. Always operate the boat in an open area.
- Do not use the reverse function to slow down or stop the boat, as it could cause you to lose control, be ejected or impact the steering wheel or other parts of the boat. This could increase the risk of serious injury. It could also damage the shift mechanism.
- Reverse can be used to slow down or stop during slow speed maneuvering, such as when docking. Once the engine is idling, shift to REVERSE and gradually increase engine speed. Make sure that there are no obstacles or people behind you before shifting into REVERSE.
- Stop the engine and remove the clip from the engine stop switch before removing any debris or weeds that may have collected around the propeller.



WATER SPORTS

⚠ WARNING *Control Hazard: It is unlawful to participate in water sports while under the influence of alcohol or other drugs.*

Some boats are not designed or recommended to be used for water sports. Use boats equipped with a ski-tow eye or other specially designed line attachment device to pull persons or equipment engaged in a water sport.

Water sports may include, but are not limited to, any activity performed in the water such as swimming, diving, snorkeling, knee boarding, tubing, skiing, parasailing, kiting, gliding or any activity using a device that may be pulled or pushed by a boat.

Check with local and state authorities or water sports clubs and affiliations for additional information.

PLATFORM DRAGGING

Every year tragic deaths occur from the negligence of unsafe boating and dangerous activities.

NOTICE *It is UNLAWFUL to be on or holding on to the boarding platform, swim deck, swim step, swim ladder or any portion of the exterior of the transom at any time while the boat is running or underway in any direction and at any speed.*

⚠ WARNING *Personal Injury Hazard: Body, teak or platform dragging is extremely dangerous and can be fatal. Never hold on to the transom of a boat while in the water when the boat is running or underway.*

- *Do not use the boarding platform or ladder for any purpose other than boarding the boat or entering the water.*
- *Do not use the boarding platform or ladder while the engine is running.*
- *Do not swim under the boarding platform when the engine is running.*

These dangerous and even fatal activities can lead to any or all of the following, as well as other dangers not listed here:

- Carbon monoxide poisoning
- Severe injury from a rotating propeller
- Drowning or entrapment under the water



WATER SPORTS GUIDELINES

Boat Operator, Occupants and Participants

The following water sports guidelines only cover the general conditions that frequently arise. The participants must respond to the constantly changing weather and the conditions of the sea by using reasonable and safe judgment in light of the circumstances.

- Always ensure that all water sports participants and occupants of the boat, especially the operator, are fully aware at all times of the participants' condition and location in the water, as well as the surrounding environment.
- Make safety the primary concern of all involved during the activity. Only allow safe and capable participants to engage in the activity.
- The boat operator and water sports participants must always know their limitations in the activity and never exceed them.
- Never perform water sports in or near:
 - Congested areas
 - Restricted areas
 - Navigation or other waterway markers
 - Other boats
 - Other water sports participants
 - Obstructions in the water
 - Shorelines
 - Shallow water
 - Hazardous weather conditions
 - Hazardous waterways, rapid moving water, dams, spillways, etc.
 - Areas or times of restricted visibility
 - Hours between sunset and sunrise
 - Locations too far from shore that could hinder immediate rescue or emergency help if needed
- Always engage in water sports activities in safe waterways only.
- Always attach the water sports tow rope to approved attachment points on the boat.
- Never jump from a boat that is moving at any speed, and do not enter or exit the water when the engine is running.
- Never use different length ropes simultaneously for water sports activities.



- Always make sure that participants know and use approved skiing hand signals and common skiing courtesy.
- Before starting, always agree to speed and communication hand signals between the boat operator, spotter/observer and participants.
- Before starting, always inspect the water sports equipment and tow eye, tow point and tow line for safe operating condition, or damage that may lead to failure.

Know Water Sports Hand Signals

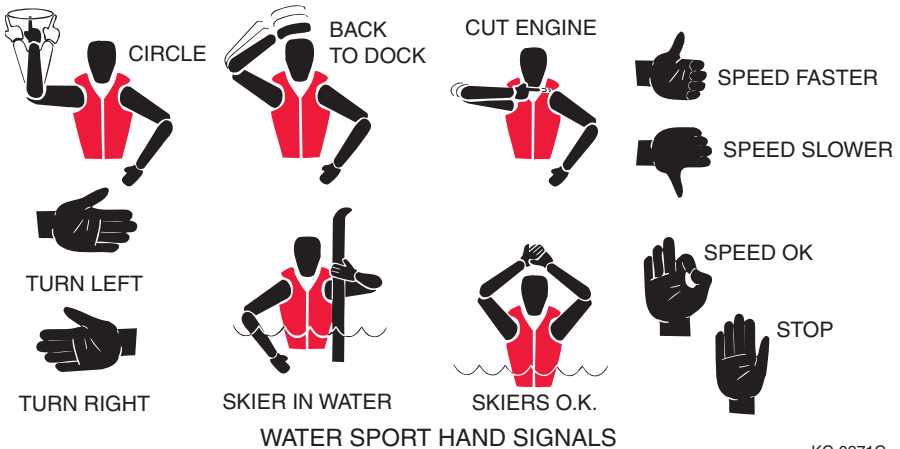

KC-0271C

Boat Operator Specific Guidelines

The following guidelines are for the boat operator while a participant is in the water.

- Always have a “spotter” (designated observer) other than the boat operator on board to ensure the safety of the participants in the water and provide communication to and from the boat operator and the participants.
- Always turn the engine off from a safe distance when approaching participants in the water and allow them to reach the boat. Never run the engine near a person in the water.
- Never operate the boat in reverse to retrieve anyone in the water.
- Always return immediately to a fallen water sports participant. Always approach the participant on the operator’s side while keeping the participant in view from a direction opposite the wind or seas.



- Never drive directly at a person in the water or directly behind another boat.
- Always maintain a safe distance from people and objects in and on the water.
- Always look in the direction you plan to turn before turning the boat to pick up a fallen skier.
- Never retrieve any object from the water while the engine is running.
- Always keep the skier in view when the skier is entering or exiting the boat.
- Always watch the skier as the line begins to tighten (in case the rope wraps around ski or skier).
- Always look ahead before starting.
- Always start from a safe place with good forward and peripheral visibility.
- Always check direction of steering before starting, ensuring that the boat steers straight.
- Always be aware of what is occurring in front of the boat, and of a participant's condition.
- Always display a "skier down" flag whenever a skier is in the water and not skiing.
- Always follow the approved towing pattern for the waterway in which you are operating.

Additional Guidelines for Participants in the Water

The following guidelines are for the water sports participant.

- Never participate in water sports if you cannot swim.
- Always wear a bright-colored USCG-approved activity life jacket at all times. Wear suitable protective clothing or gear and/or a wet suit to prevent impact injuries, abrasions and hypothermia.
- Never approach or enter the boat if the engine is running.
- Always avoid the boat's propeller. Even when the propeller is not rotating, its sharp edges can cause serious injury.
- Never put any part of your body through the handle of the ski line or wrap the line around any part of your body.
- Never enter the water from a boat that is running or moving at any speed.
- Always indicate that you are clear of the boat prior to the operator starting the boat or putting the boat into gear and tightening the rope.



Reboarding

⚠ WARNING *Personal Injury Hazard: Always turn the engine off whenever anyone is in the water near the boat.*

Use caution when reboarding boats without ladders. Assisted reboarding requires the boater to first determine how he/she will attempt to reboard the boat before entering the water. Take into account your physical capabilities and the layout of the boat, including mounted accessories. We recommend that all occupants test reboarding of the boat in a safe, controlled environment before use. Unless a boater is fully confident they can reboard the boat unassisted, a permanently attached reboarding ladder is necessary.

Boats with low freeboard can be reboarded without the use of ladders or assistance, but it is important to remain calm. Locate the lowest portion of the boat (lowest freeboard) where reboarding would be easiest to do with a solid handhold to assist with pulling oneself into the boat. Small boats can be unstable, so it is important to be careful not to flip the boat during reboarding. To reboard:

1. Make sure the engine's propeller and mounted accessories are a safe distance away from you being accidentally hit.
2. Locate a solid handhold and pull until your torso or leg onto the boat.
3. Roll the rest of your body onto the deck of the boat.

Reboarding ladders are available for purchase from the boat dealer.

Using the Boarding Platform/Ladder

⚠ WARNING *Personal Injury Hazard: Always turn the engine off whenever anyone is in the water near the boat.*

To board, carefully deploy and use the boarding ladder if available. You may also pull yourself onto the boarding platform to enter the cockpit of the boat. Boats equipped with a boarding platform have a few extra precautions to be aware of:

- NEVER allow anyone on the boarding platform or in the water near the platform while the engine is running.
- NEVER attempt to surf on or off the platform while the engine is running.
- NEVER "platform drag" or touch the boarding platform from the water while the engine is running.
- NEVER exceed the weight capacity of the boarding platform. All boarding platforms have weight limits. If there is no capacity decal, ask the dealer.



- Boarding platforms may be wet and slippery. Advise passengers to use caution and any available handholds when using the platform. Never apply wax to the working deck portion of the platform.
- If the boarding platform is equipped with a ladder, be sure the ladder is fully retracted and secured before operating the boat.
- If the boarding platform is removable, be sure it is properly secured before operating the boat.

Water Sports Safety

IMPORTANT

The following water sports safety warnings and practices represent some (but not all) common risks encountered by users. Always use common sense and good judgment.

Before skiers/riders get in the water: Waterskiing or riding instruction is recommended in advance. Instruction will teach general safety guidelines and proper waterskiing or riding techniques, which may reduce their risk of injury. For more information on waterskiing or riding schools, contact the dealer, association or local waterskiing club.

Inspect all equipment prior to each use. Check bindings, fins, tube, attachment, tow rope and flotation device. Do not use if damaged.

Special boat considerations: A knowledgeable and responsible driver along with a separate observer is the most important safety device on any boat.

- Some states have specific regulations for allowable propulsion systems that can be used for tow sports, especially wake surfing. It is the operator's responsibility to know the applicable regulations.
- Never exceed the passenger or weight limitations of the boat.
- Never allow passengers to hang outside the boat or towed device or sit on the gunwales or anywhere outside of the normal seating area.
- Never allow water to overflow the bow or gunwales of the boat.
- Uneven weight distribution or additional weight may affect the handling of the boat.



Tow ropes: Tow ropes come in different lengths and strengths for different activities. Make sure any rope used is suited for that activity and that it is in good condition.

- Never use a rope that is frayed, knotted, unraveling or discolored from use or being left in the sun. If a rope breaks while in use, it can recoil at the skier/rider being towed or into the boat where it might strike passengers. Replace tow ropes with any sign of damage.
- Never use a tow rope with elastic or bungee material to pull skiers or riders.
- Rope should be attached to the boat in an approved fashion with hardware designed for towing. Refer to the boat manual for instructions on proper tow rope attachment.
- Always keep people and tow ropes away from the propeller, even when idling.
- If a tow rope should become entangled in a propeller, shut off the engine, remove the key and secure it in a safe location before retrieving the rope.
- Tow ropes should be neatly stowed in the boat when not in use.

Preparing to ski or ride: Always have a person other than the driver act as an observer to look out for the skier/rider.

- Be sure the driver is aware of the experience and ability level of the skier/rider.
- The driver, observer and skier/rider need to agree on hand signals before skiing or riding. Signals should include READY, STOP, SPEED UP and SLOW DOWN.
- Start the engine only after making sure that no one in the water is near the propeller.
- Turn off the engine when people are getting into or out of the boat, or in the water near the boat.
- Always make sure the tow rope is not wrapped around anyone's hands, arms, legs or other parts of the body.
- Start the boat and move slowly to remove slack until the tow rope is tight.
- When the skier/rider signals READY "hit it" and there is no traffic ahead, take off in a straight line. Adjust the speed according to the signals given by the skier/rider.



Skiing or riding: The boat and skier/rider should always maintain a sufficient distance from obstacles so a skier/rider falling or coasting and/or boat will not encounter any obstacle.

- Do not use in shallow water or near shore, docks, pilings, swimmers, other boat or any other obstacles.
- Use only on water.
- Never attempt land or dock starts or stops. This will increase the risk of injury or death.
- The faster the skier/rider skis or rides, the greater their risk of injury. The skier/rider should be towed at an appropriate speed for his or her ability level.
- Never make sharp turns that may cause a slingshot effect on the skier/rider's speed.

Fallen skier or rider: Falling during water sports is commonplace and injuries can occur from a variety of causes.

- If the skier/rider does not immediately indicate that they are "OK," assume that they need assistance.
- Circle a fallen skier/rider slowly to return the tow rope handle or, pick up the fallen skier/rider.
- Turn off the engine when near a fallen skier/rider.
- Always keep the fallen skier/rider in view and on the driver's side of the boat.
- Display a red or orange "skier down" flag to alert other boats that a skier/rider is down if required by the state in which you are operating.

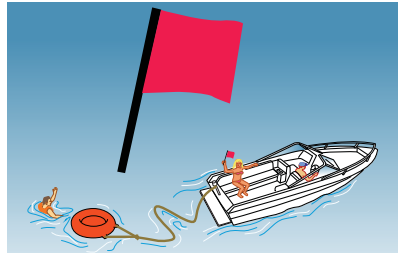

KC-6017

Water Sports and Towing Safety

Boat operators, skiers and boarders must all be aware of current boating and water sports rules and pay attention to safe operating procedures and skiing practices at all times. If skiing or boarding is a new sport to you, seek certified training before starting. Thoroughly read all information provided by the water sports equipment manufacturer.

Always remember that the majority of water sports injuries are the result of impacts with other objects. Know the area you are boating in.



Always maintain a clear vision of where you are going and be aware of what is going on around you. Constant vigilance will go a long way toward preventing accidents. Skiers, boarders and other water sports participants must always wear a USCG-approved life jacket. It's the law!

Contact with rotating propellers is one of the most dangerous hazards that occurs from negligence of operators, passengers and bystanders. A propeller is designed to travel in the water and rotates at a speed that can cause death if it comes into contact with a human. Severing, deep lacerations, blood loss, trauma and exposure to microorganisms in the water that enter the bloodstream can result in death or serious injury.

STOP PROPELLER STRIKES by always using caution and:

- OBSERVING all warnings and keeping all safety equipment in use and in place.
- STOPPING the engine when swimmers are near the boat and in the water.
- MAKING SURE all passengers are seated on a horizontal seat cushion whenever the boat is in gear or moving.
- NOT ALLOWING passengers to enter the water when the engine is running.
- USING the boat's emergency stop switch at all times.
- MAKING SURE all operators are properly trained and qualified to operate the boat.
- KEEPING your eyes on your path as well as the water sports participant.
- NOT ALLOWING water sports participants to be in the path of other boaters.
- STAYING CLEAR of swimmers and other water sports participants by maintaining visual surveillance.
- KNOWING the correct water sports hand signals.
- NOT ALLOWING children under 11 years of age to occupy the open bow area unless accompanied by an adult.
- USING an observer during water sports activities.



Water Sports Responsibility Code

BE AWARE there are risks in boating and water sports that good judgment and personal awareness can help reduce. To increase enjoyment of water sports, follow the 10 points of the code.

In water sports, it is the boater's responsibility to:

- ALWAYS become familiar with applicable laws, waterways and inherent risks.
- ALWAYS have a capable observer in addition to the driver, and use agreed-on hand signals.
- ALWAYS wear a properly fitted life jacket approved by your country's agency.
- ALWAYS read the user's manual and inspect equipment before use.
- ALWAYS ski and ride under control, at proper speeds and within your limits.
- ALWAYS turn the ignition off when anyone is near the boat power drive unit.
- ALWAYS stay clear of engine exhaust to avoid carbon monoxide poisoning.
- NEVER "platform drag" or touch boarding platform while the engine is running.
- NEVER ski or ride near swimmers, shallow water, other boats or obstacles.
- NEVER operate boat and never ski or ride under the influence of alcohol.

Driver: Best Practices

- The boat driver plays a critical role in the enjoyment and safety of all towed water sports participants. Do not allow inexperienced drivers to drive for skiers/riders without thorough instruction and training. We encourage all boat operators to take a boater's education course. See the state's boating authority for available courses or other operating requirements.
- Keep music at reasonable levels. Sound travels well over water.
- Wait for a clear boat path ahead before accelerating.
- Make sure to use the proper rope for the sport. A rope designed to pull a skier is not the recommended rope for towing a tube.
- If skiing, boarding or tubing with more than one person, make sure all tow ropes are the same length.
- Keep a 150-foot buffer zone on all sides of the boat and stay in water that is safe for the skier/rider and draft of the boat.
- Make sure the tow line unwinds smoothly without getting snagged on anyone or anything.



- Idle forward to make the rope tight.
- Accelerate only when the tow rope is completely tight and the skier/rider has given the “hit it” signal. The words GO and NO can be easily confused with nearby wind, water and engine noise. It is best to find another signal other than GO to tell the driver to power up. “Hit it” or “boat driver” are better options.
- Always approach fallen skiers/riders in the water from the driver’s side so the driver does not lose sight of them.
- Minimize repetitive passes on any one portion of shoreline. Once you’ve run the same line for a while, move on to another area.

TURN OFF ENGINE when a skier/rider is near the boat, rather than running the engine in NEUTRAL. An accidental bump of the throttle when the engine is running could put the boat in gear.

- DO NOT let the tow rope slip under the boat and become tangled in the propeller. It is a good practice to keep a knife on board should this situation occur.
- Always pay attention to the water ahead, the surrounding traffic and the onboard observer. The observer must always keep the boater aware of the skier/rider status.
- DO NOT whip skiers or riders near shores, docks, other boats or fixed obstructions; they can glide 100 feet or more after they let go of the rope.

**WARNING**

Entanglement Hazard: Never accelerate before the rope is 100% tight and before the skier/rider gives the “hit it” signal. Accelerating before the “hit it” signal is given could result in the skier/rider becoming entangled in the rope.



Driving Pattern

Check with local lake laws before driving any pattern. Some areas require operators to drive skiers/riders in preset patterns.

Operators who want to minimize the rough water for the skier/rider should use a dog-bone pattern when driving. A dog-bone pattern follows the same path from one end of the course to the other, with tight controlled turns at each end. Use this pattern where few other boats are operating.

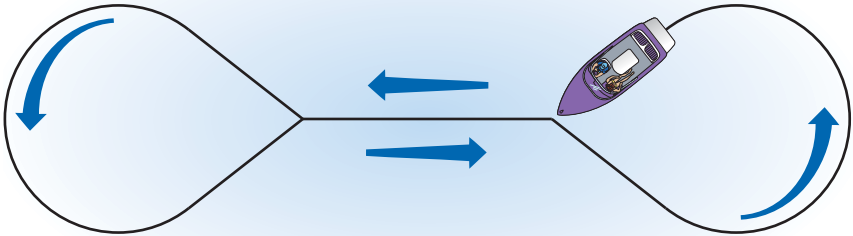

KC-0317C-A

In areas where many boats are operating, use a large racetrack pattern.

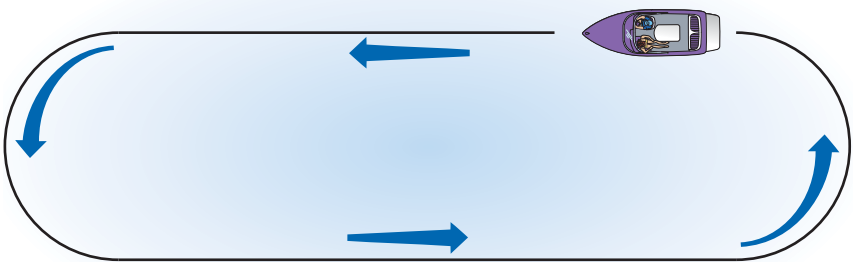

KC-0358



Falling Tips for Every Sport

- Sudden falls happen. DO NOT put any body parts (arms, legs, head) inside the rope handle.
- Tighten the life jacket straps for a snug fit.
- Let the handle go as soon as you sense you're about to fall. Falling is better than dragging.
- Roll with it. Bow your head, bend your knees, tuck in your arms and make like a beach ball.
- Signal the observer to let them know you are OK after a fall.
- After you fall, lift the ski or board above the water so other boaters can see you.
- When learning advanced maneuvers, it's best to seek training from a professional.
- A little advice will cut down on falls, shorten the learning time and reduce the chances of an injury.

Water Sports Tips

These tips are designed to help speed learning while ensuring safety. Practice, training from a professional and advice from experienced boaters are the best tools for learning safety when it comes to water sports.

For additional information visit: www.usawaterski.org

REMEMBER: It is important to follow the manufacturer's recommendations for the intended use of the water sports equipment.

REMEMBER: It is illegal in many states to participate in towed water sports without a USCG-approved life jacket. Be aware that some specialized water sports vests are NOT USCG-approved and should be worn in addition to a USCG-approved life jacket.

BE AWARE: The boater is responsible for their own wakes. Be considerate of other boaters, especially small fishing boats, canoes, kayaks, paddleboards and other low-profile boats that can overturn easily. Also, be aware of your wakes in relation to swimmers, docks and boats tied to docks.

Section 3

BOATING REGULATIONS AND YOUR RESPONSIBILITIES

The U.S. Coast Guard (USCG) is the federal authority on U.S. coastal and inland waterways, but state and local regulations may exist that exceed USCG regulations. The purpose of all these regulations is to assist the boating public and maintain navigational order on waterways.

Many state equipment requirements go beyond USCG requirements. Contact state and local boating authorities for further information. Equipment requirements for coastal and inland waters differ. Check with local authorities or the USCG for further information about coastal water requirements.

Boating regulations are enforced by USCG, state and local authorities. Operators/owners are subject to marine navigation regulations for both federal and state waterways. Operators/owners must comply if enforcement officers signal them to stop the boat or if they ask to board the boat.

Many USCG, state and local resources are available. For additional and current information on regulations, safety and navigation, contact the local USCG unit or local marine authority.

See the References and Contact Information section of this manual for a list of resources.

BOAT OWNER / OPERATOR RESPONSIBILITIES

As a boat owner/operator, understand and be aware of USCG federal regulations as well as state and local regulations where operating the boat. Boating regulations include, but are not limited to, boat regulations, boat equipment regulations and navigational regulations.

Operators/owners must have on board at all times all mandatory safety and boat equipment as regulated by the governing authorities. All equipment must be maintained in proper working order.

SAFETY

Boat owners/operators are legally responsible for their safety, the safety of their passengers and the safety of other boaters. In addition, they are responsible for the operation and navigation of the boat under all operating conditions. The boat must be in compliance with USCG safety equipment regulations.



REGISTRATION

The USCG requires that all power boats operated on the navigable waters of the United States be currently registered in the state in which they are principally used. Many states require current registration in that state whenever boating on waters within their state boundary. Always contact state boating authorities (and authorities in neighboring states) for registration information on boats and trailers.

Registration numbers must be current and clearly displayed on the boat according to the defined regulations. Registration certificates must be current and on board at all times.

State and local authorities may require additional registration for boating on certain waterways. Check with state and local authorities for additional registration information.

For more information visit:

- U.S. Coast Guard Office of Boating Safety:
<http://www.uscgboating.org>
- National Association of State Boating Law Administrators:
<http://www.nasbla.org>

INSURANCE

Boat owners are legally responsible for any damage or injury caused when they operate the boat when an accident or collision occurs. They are also legally responsible even when someone else operates the boat and causes damage or injury. Individual states have laws detailing minimum insurance needs. Contact the insurance agent to verify the type of insurance needed BEFORE operating the new boat.

REPORTING ACCIDENTS

The USCG requires the owner/operator of a boat involved in an accident to report the incident to the proper marine law enforcement agency for the state in which the accident occurred. If a person dies or disappears as a result of a recreational boating accident, the boat owner/operator must immediately notify the nearest state boating authority. If a person dies or has injuries requiring more than first aid, the owner/operator must file a formal report within 48 hours of the accident. An owner/operator has 10 days to file a formal report for accidents exceeding \$500 in property damage or complete loss of the boat. Go to <http://uscgboating.org/recreational-boaters/>, Accident Reporting, for information and form download.



BOATING UNDER THE INFLUENCE



KCB-0011

Federal and state laws prohibit the operation of a boat while under the influence of alcohol or drugs, and authorities actively enforce these regulations. If the operator's blood alcohol content is at or above the legal limit, violators are subject to civil and criminal penalties and imprisonment. Operating a boat under the influence can also result in a loss of motor vehicle driving privileges.

Alcohol and drugs slow reaction time and affect judgment. This type of impaired operation may result in death or severe personal injury.

Owners/operators are responsible for their passengers, including alcohol and drug use and onboard behavior.

Regulations and penalties for operators and passengers may vary from state to state. Contact local and state boating authorities for specific information.

OPERATOR'S LICENSE AND EDUCATION

This manual does not provide complete training on all aspects of boating safety, operation or regulations. Boating authorities highly recommend that all boat operators and passengers seek additional training in boating safety and seamanship from a USCG-approved course.

Some states require youths 16 years of age and younger to complete a boating safety course before operating any boat. Many others require operators under the age of 18 to be licensed in small boat operation.

Check with state and local authorities for requirements of an operator's license, certificate or training before you or anyone operates the boat.

See the References and Contact Information section of this manual for a list of some of the agencies and organizations that offer water/boating safety courses, first aid/CPR, or other recommended training and/or information.

OPERATION BY MINORS

Minors must always be supervised by an adult whenever operating a boat. Many states have laws regarding the minimum age and licensing requirements of minors. Regulations may vary from state to state. Contact local and state boating authorities for specific information.



EMERGENCY ASSISTANCE

An operator seeing a distress signal or suspecting a boat is in trouble must assume it is a real emergency and render assistance immediately. By law, the operator in charge of the boat is obligated to provide assistance to any individual in danger if such assistance can be provided safely. Failure to render assistance can result in a fine and/or imprisonment. The 1971 Boating Safety Act grants protection to a “good Samaritan” boater providing good-faith assistance, and absolves a boater from any civil liability arising from such assistance.

NEGLIGENT OPERATION

Federal law prohibits the negligent or grossly negligent operation of a boat and/or interference with the safe operation of a boat so as to endanger lives and/or property. Some actions that may constitute grossly negligent operation (criminal offense) are:

- Operating a boat in a designated swimming area
- Excessive speed in the vicinity of other boats or in regulated waters
- Hazardous waterskiing or other water sports practices
- Bow riding, or riding on a seatback, gunwale, boarding platform or transom
- Operating a boat while under the influence of alcohol or drugs (severe penalties may be imposed for boating under the influence [BUI])

Other actions that constitute negligent operation, such as, but not limited to:

- Failure to use handhold
- Overloading or improper loading
- Using a boat in weather or sea conditions beyond the intended design of the boat or beyond the skill or experience of the operator
- Continued operation with operator’s visibility blocked or impaired
- Modification to boat causing an unsafe operating condition

RESTRICTED AREAS

SECURITY ZONES

Operators must avoid all waterways and areas that are restricted, such as military installations, power plants and petroleum and chemical facilities. Because of the threat of terrorism, the U.S. Coast Guard has implemented and will continue to enforce strict limits on boats near U.S. Navy and U.S. Coast Guard ships and other potential targets.



NAVAL VESSEL PROTECTION ZONES

Do not approach within 100 yards of any U.S. Naval vessel. Slow to minimum speed within 500 yards of any U.S. Naval vessel. Operators needing to approach within 100 yards to ensure a safe passage in accordance with the Navigation Rules must contact the U.S. Naval vessel or the U.S. Coast Guard escort vessel on the boat's VHF radio (channel 16) for authorization.

COMMERCIAL SHIPPING SAFETY ZONES

Do not operate the boat near cruise liners or certain waterfront commercial installations such as ferry terminals. Observe and avoid all security zones and commercial port operations.

BRIDGES AND SHIPPING CHANNELS

Do not stop or anchor beneath bridges or in shipping channels. Operators doing so should expect to be asked to move and/or be boarded by law enforcement officials. Anchoring in these areas is dangerous for the operator and others on the water.

AMERICA'S WATERWAY WATCH

Boat operators can help the U.S. Coast Guard in keeping waterways and coastal installations safe and secure. Boat operators can do this by participating in America's Waterway Watch (AWW). Boaters reporting suspicious activities to AWW should call 877-24WATCH if noticing suspicious activity or behavior on or near the water.

In cases of immediate danger to life or property, call the U.S. Coast Guard on channel 16 VHF-FM or dial 911 for emergencies.

FISHING

Fishing can be very exciting and distracting for the operator when the action gets intense. Operators must always be conscious of the primary responsibility, which is the safe operation of the boat and the safety of passengers and other boats in the area.

Always make sure the helm is properly manned and is never left unattended while trolling. If the boat is equipped with a tower, exercise caution and sound judgment whenever someone is in the tower. Remember, weight in the tower raises the boat's center of gravity and the boat's motion is greatly exaggerated for the person in a tower.



An operator fishing in an area that is crowded with other fishing boats may have difficulty following the rules of the road. This situation can become especially difficult when many boats are trolling. Being courteous and exercising sound judgment is essential. Avoid trying to assert the right-of-way and concentrate on staying clear of other boats. Prevent the boat from becoming entangled in lines and from cutting into lines. Also keep in mind that fishing line wrapped around a propeller shaft can damage seals in the engine lower unit.

There is currently a tremendous drain on our fishing resources. Excessive fishing and hunting, as well as pollution, have strained the fish and game population. Help out by keeping only what you will eat; practice catch-and-release and obey bag limits.

MONOFILAMENT FISHING LINE

Wildlife can experience harm from becoming entangled in or ingesting monofilament fishing line if it is left in the water or on shore. Line in the water can also endanger swimmers and divers and become tangled in boat propellers, causing damage. It can last for years in water, posing a threat for a long time. Fishing line can remain a problem even if put in the trash, because birds can take it from an open bin and become entangled or it can entangle wildlife at landfills.

Many states and private boating/wildlife organizations sponsor programs to collect used line for recycling into new products. Operators who carry used line or happen upon it while boating can dispose of it in recycling bins located at many marinas, launches, tackle shops and state service centers.

WAKE

Boat owners/operators are responsible for the wake the boat creates. Regulations may vary from state to state. Contact local and state boating authorities for specific information, as owners/operators may be responsible for any damage or injury their wake causes. Always be alert for no-wake zones and be courteous of others while boating. Excessive and unexpected wakes can cause dangerous and even life-threatening situations.

NOISE

Boat owners/operators are responsible for the noise the boat creates. Many state and local boating authorities enforce noise limits that may restrict engine noise, radio volume or even loud talking. Regulations may vary from state to state. Contact local and state boating authorities for specific information.



SPEED

Boat owners/operators are responsible for maintaining the boat under control at a safe speed. Many state and local boating authorities enforce speed limits. Regulations may vary from state to state. Contact local and state boating authorities for specific information.

SHALLOW WATER BOAT STABILITY

Boat designs for flats, bays, poles and skiffs are very similar. Because of the unique requirements for a shallow draft, stability issues can arise under certain conditions, especially during quick turns. Take time to learn the characteristics of the boat alone and in open water away from other boaters. Make gradual increases in speed and radius to get the feel of stability under various conditions and be ready to make adjustments quickly. Slow down when boating with passengers to avoid possible ejection from the boat.

PROTECTING THE ENVIRONMENT

Our lake, river and ocean resources must be protected to be enjoyed by future generations. Boat owners/operators are responsible for protecting the natural environment and wildlife by keeping waterways clean.

U.S. waters are covered by several water pollution regulations administered by numerous federal and state agencies. Laws vary between local, inland, coastal, ocean and international waters. Laws can be enforced by local and state authorities as well as the USCG. For recreational boats, U.S. Federal Water Pollution Control, Oil Pollution Control and Refuse Acts cover U.S. waters, and the MARPOL treaty covers international waters. In any case, pollution prevention centers around three areas:

- Sewage pollution
- Garbage (solid waste) pollution
- Oil pollution



BOATING REGULATIONS AND YOUR RESPONSIBILITIES

As a boater, make it a point NOT to dump or discharge ANYTHING into waters and tell passengers to respect this rule. Return all trash after boating and dispose of it properly on shore.

DISCHARGE OF OIL PROHIBITED

The Federal Water Pollution Control Act prohibits the discharge of oil or oily waste into or upon the navigable waters of the United States, or the waters of the contiguous zone, or which may affect natural resources belonging to, or under the exclusive management authority of the United States. If such discharge causes a film or discoloration of the surface of the water, or causes a sludge or emulsion beneath the surface of the water. Violators are subject to substantial civil penalties and/or criminal sanctions including fines and imprisonment.

KC-6020

MARPOL TREATY

The USCG enforces the International Convention for the Prevention of Pollution from ships, commonly referred to as the MARPOL Treaty (MARine POLLution). This treaty prohibits the overboard dumping of all ship-generated plastics, chemicals, garbage and oil. Contact the USCG for further information.

AQUATIC INVASIVE SPECIES (AIS)



KC-6027

Stop aquatic hitchhikers. Waterways are under assault by nuisance invasive species transported from one body of water to the next by ships and boats. Recreational boaters can help stop the spread of AIS with thorough equipment inspection and cleaning. Many waterways popular with trailer boaters have mandatory state or local inspection and decontamination centers.

Stop the transport of invasive species:

- REMOVE plants, fish, animals and mud from boots, gear, boat trailer and vehicle.
- CLEAN the gear before entering and leaving the recreation site.
- DRAIN bilge, ballast, wells and buckets before leaving the area.
- DRY equipment before launching the boat into another body of water.
- DISPOSE of unwanted bait in a sealed container.

Inspection, rinsing, flushing or high-pressure washing removes AIS, while hot water kills AIS. In the absence of hot water or high pressure, rinsing with tap water and completely drying will help prevent the spread of AIS. For more information visit: <http://StopAquaticHitchhikers.org>.



PAINTS

Boat owners are responsible for the environmental regulations that may govern the use of antifouling paint. If the boat is kept in water where marine growth is a problem, the use of antifouling paint may reduce the growth rate. Regulations may vary from state to state. Contact local and state boating authorities for specific information.

CLEANING AGENTS

Boat owners are responsible for the environmental regulations that may govern the use of cleaning agents. There are many “green” cleaner choices available for most any material on the boat. If using household cleaners, use them sparingly and never discharge them into waterways. Do not mix cleaners and be sure to use plenty of ventilation in enclosed areas. Avoid using chlorine, solvents and products that contain phosphates, as well as non-biodegradable or petroleum-based products. Regulations may vary from state to state. Contact local and state boating authorities for specific information.

EXHAUST EMISSIONS

Boat owners are responsible for the exhaust emissions from the boat. Increased exhaust (hydrocarbon) emissions, which are regulated by the EPA, pollute the water and air. Contact the dealer and the engine manufacturer for more information. Additional restrictions may apply and vary from state to state. Contact local and state boating authorities for specific information.

ADDITIONAL PROPOSITION 65 INFORMATION

A wide variety of components used on this boat contain or emit chemicals known to the state of California to cause cancer, birth defects and other reproductive harm.

Examples include:

- Engine and generator exhaust
- Engine and generator fuel and other liquids, such as coolants and oil, especially used motor oil
- Cooking fuels
- Cleaners, paints and substances used for boat repair
- Waste materials that result from wear of boat components
- Lead from battery terminals and from other sources, such as ballast or fishing sinkers



To avoid harm:

- Keep away from engine, generator and cooking fuel exhaust fumes.
- Wash areas thoroughly with soap and water after handling the substances above.

⚠ WARNING

A wide variety of components used on this vessel contain or emit chemicals known to the State of California to cause cancer and birth defects and other reproductive harm.

EXAMPLES INCLUDE:

Engine and generator exhaust.

Engine and generator fuel, and other liquids such as coolants and oil, especially used motor oil.

Cooking fuels.

Cleaners, paints and substances used for vessel repair.

Waste materials that result from wear of vessel components.

Lead from battery terminals and from other sources such as ballast or fishing sinkers.

TO AVOID HARM:

Keep away from engine, generator and cooking fuel exhaust fumes.

Wash area thoroughly with soap and water after handling the substances above.

California Health & Safety Code 25249.5-.13

KC-0206C-B

Section 4

EMERGENCIES

Be prepared to deal with emergencies before they happen. Try to formulate a plan for each type of emergency in advance in order to make decisions quickly and without hesitation. Precious moments lost can mean the difference between losing and saving a life.

Before operating the boat, review *Safety in Section 2*.

FIRST AID / MEDICAL EMERGENCIES

Every second counts toward preventing injury or death in case of a medical emergency. Boaters must have proper training and take necessary preventive measures to properly assist in times of need. Carrying an adequate and current first aid kit is critical in the immediate response and care of someone in need of medical attention. Always have dry blankets readily accessible to help prevent hypothermia. For additional information on medical, first aid and safety training such as CPR, contact your state and local authorities, or visit the Red Cross website:

<http://www.redcross.org>.

EMERGENCY PREPARATION CHECKLIST

In addition to a safety equipment list, have an emergency checklist on board to assist in times of emergency. Use the following topics as a guideline to develop a list of emergency procedures and instructions for the use of visual and audible distress signaling devices, radios, first aid kits and all related information that could assist you or others in the event of an emergency.

USING DISTRESS SIGNAL DEVICES AND CALLING FOR HELP

Ensure all passengers understand how to operate all onboard visual and audible distress signaling devices and communication equipment. Keep all distress signaling devices and communication equipment in a readily accessible area and within immediate reach at all times.

An emergency can occur when you least expect it. Be sure you and your passengers know how to use all types of distress signaling devices.

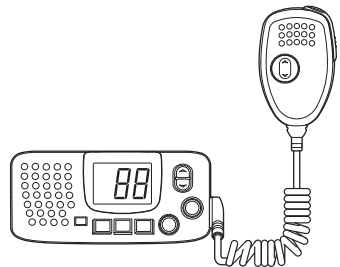

KC-0246-B



See the Markers, Warnings and Advisories section of this manual for more signaling devices.

Seconds count during emergencies. Knowing the proper way to use the distress signaling devices aboard the boat can help save lives.

- **MAYDAY radio call** – A mayday call is reserved for life-threatening situations, such as fire, severe weather or sinking, where lives are in imminent danger or the boat is in danger of sinking. Start the broadcast clearly and calmly with **“Mayday - Mayday - Mayday.”**
- **PAN-PAN (pahn-pahn) radio call** – A pan-pan call is used for urgent but non-life-threatening situations where there is no immediate danger to lives or the boat, such as a loss of steering control or taking on water of any amount. Start the broadcast clearly and calmly with **“Pan - Pan - Pan.”**
- **Securite (se-cure-ih-tay) call** – A securite call is used for non-life-threatening situations to notify authorities and others in the vicinity of important navigation and weather alert calls. Start the broadcast clearly and calmly with **“Securite - Securite - Securite.”**

In an emergency situation the responder needs to know four important pieces of information:

- The exact nature of the emergency and an assessment of the severity
- Number of people on board
- The location (navigation marker, visual reference or GPS coordinates in open water)
- What the boat looks like (hull and top colors, unique features, flags, etc.)

For additional information on the safe and proper use of distress signaling devices and the safe and proper use of emergency communication equipment, contact state and local authorities. Additional information can be found on the USCG website:

<http://www.uscgboating.org>.

REQUESTING ASSISTANCE (NON-DISTRESS CALL)

If a boater contacts the USCG on Channel 16 VHF-FM or Channel 70 DSC regarding a non-distress situation, the USCG will offer to contact any assistance provider (commercial or friend) the boater requests or will issue a Marine Assistance Request Broadcast (MARB) if the boater has no preference of service.



LAW OF SALVAGE

If boaters require assistance while cruising in the Great Lakes, coastal or ocean waters, they should use caution **before** allowing any towing company or private agency to pass a line to the boat. The law of salvage says, among other things, “...any vessel, if rendered assistance from a towing company or private agency, can be forced to relinquish a portion of the vessel’s worth for the assistance received.” While this is very rare with recreational boats, it can happen.

Before taking the line boaters must establish that they do not agree to any salvage rights and wish to be assisted on a contract basis. Boaters must then establish the contract price and payment terms. Boaters should accept the tow line only when the captain of the company/agency acknowledges the contract price and payment. Most tow companies are reputable and post terms and pricing on their websites.

If boating in the Great Lakes, coastal or ocean waters, it is a good idea to have a membership in a national towing service. This membership can significantly reduce the costs of towing if ever needed.

FIRE AND EXPLOSION



WARNING *Fire/Explosion Hazard: Gasoline is extremely flammable and highly explosive under certain conditions.*

- Do not smoke or allow open flames or sparks nearby when refueling.
- Do not store fuel in any containers or compartments which are not designated for fuel storage.
- Static electricity can be generated while fueling and can cause a fire or explosion. To prevent electrostatic spark when refueling, make sure the nozzle is in contact with the fill pipe at all times.
- Avoid damaging fuel lines and connectors and make sure fuel does not contact hot engine parts.
- Do not confuse the fuel fill deck plate with the water or waste fill plates, if equipped. All deck plates are properly labeled. If fuel is accidentally pumped into any other deck plate, do not attempt to pump it out. Water and waste pumps are not designed to pump fuel and a fire or explosion could result. Contact the dealer to have the fuel professionally removed.
- USCG-approved fire extinguishers are required on all Class I, II and III boats.



A fire or explosion may occur when least expected. The decision to abandon the boat or stay to fight the fire is difficult and depends on many factors. Formulate a fire plan in advance to make that decision quickly and without hesitation. Keep in mind the following guidelines:

- Many fires are the result of gasoline and oil accumulating in the bilge, careless fueling practices and electrical problems. In the event of a fire, try to stop the boat and turn off the engine as quickly and safely as possible. Immediately use a fire extinguisher at the base of the flames in a sweeping motion to reduce or extinguish the fire. Ensure that all passengers are safe from immediate danger and are wearing life jackets. If the fire is located in the engine compartment (if equipped), make sure the bilge blower (if equipped) is off and do not open the engine cover.
- Once the fire is extinguished, check for other immediate fire threats and personal injuries and call for assistance immediately.
- If you are unable to easily extinguish the fire, or if the fire is uncontrollable, attempt to get yourself and all passengers off the boat and into the water. If possible, ensure that all passengers are wearing life jackets or have access to one by the time they are in the water. Before leaving the boat, if possible, verify that there is no immediate danger of fuel sitting or burning on the water's surface where you and your passengers will be floating. Immediately swim to a safe position upwind from the boat and use distress signals to get assistance.



KC-0074C-A

MAN OVERBOARD (MOB)

A high percentage of boating fatalities are the result of people falling overboard, many of whom were not wearing life jackets. If someone falls into the water unexpectedly, react quickly, as every second counts toward preventing injury or death. Keep these guidelines in mind:

- Brief passengers before leaving the dock on the proper procedures should someone fall overboard. Add this briefing to the passenger safety equipment overview.
- At the first sign that a person has fallen overboard, loudly yell “man overboard” and state which side of the boat such as “man overboard—port!” In heavy seas, throw a floatable item toward the MOB as quickly as possible to serve as a marker.



- The operator should immediately reduce speed and determine whether or not to come to a full stop or circle around.
 - If stopped, throw a flotation device (Type IV is best, but any can be used) to the victim, shut down the engines, and throw the victim a line if necessary.
 - If circling around, assign one passenger to throw a flotation device as a marker, keep the victim in sight and continuously point to the victim. Carefully navigate back to the victim, staying at a safe distance, and position the boat safely to retrieve the victim. Keep current, wind and waves in mind so the victim drifts toward the boat. Shut down the engines and throw the victim a line if necessary.
- Move passengers to the rescue side of the boat to assist the victim back into the boat.
- Avoid going into the water to assist the victim unless there is no other way to retrieve the victim. If a rescuer must go into the water, the rescuer should be wearing a life jacket. The rescuer should also be prepared for the possibility of being pulled under water by the victim if the victim is panicking.

CAPSIZING AND FLOODING

A boat may capsize or flood when least expected. Formulate a plan in advance in case of capsizing or flooding. Review the following guidelines:

- If the boat capsizes, locate all passengers and guide them to a safe flotation device or the forward hull if the boat is floating upside down.
- If possible, provide life jackets to all persons in the water and assess them for alertness and injuries.
- **STAY WITH THE BOAT!** Climb up on the hull and try to get assistance.
- Do not try to swim to shore, as it can be farther than it appears.

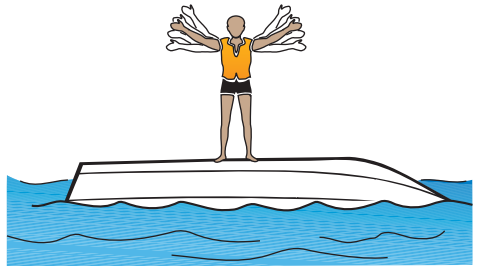

KC-0013C-A

If the boat starts to flood, slow the boat to a safe speed and stop as quickly as possible. Activate the bilge pump(s) immediately. Try to locate the cause of the flooding. If the cause is not readily apparent or not easily corrected, head for shore or shallow water as quickly as possible and call for help.



RUNNING AGROUND

When a boat runs aground, the stop is usually abrupt. Because passengers are not secured to a seat, abruptly stopping a boat while in motion can cause serious personal injury or even death. First, turn off the engine(s) immediately, locate all passengers and attend to any injuries, calling for emergency assistance as needed. Then, assess the damage to the boat and determine if there are any other immediate threats such as water leaking into the boat, or fuel or flammable materials leaking into the water or inside the boat. Immediately call for assistance if threats exist that could endanger the safety of passengers.

If there are no immediate safety threats to passengers and the boat is not damaged, attempt to propel it away from the obstacle. If the engine or drive system has been damaged and the engine restarts, be aware of excessive vibrations or uncommon noises, which usually indicate damage to the drive system. If this is the case, it is not safe to proceed. Call for emergency or professional towing assistance immediately.

⚠ WARNING *Personal Injury Hazard: Use extreme caution when using tow lines and when connecting tow lines to cleats. Death or serious injury could occur when lines and/or cleats fail while they are under extreme tension.*

If the engine restarts and the boat can be navigated safely back to port, proceed slowly to port and be ready to call for emergency assistance if needed. Even if the boat and engine appear to be in good operating condition after running aground, have the boat inspected by a qualified marine technician BEFORE returning it to service. Damage may have occurred that is not obvious to you as an operator.

DANGEROUS WEATHER

Take special precautions when encountering or operating in dangerous or hazardous weather conditions.

See the Severe Weather section of this manual for additional information.

ENGINE OR BOAT SYSTEM FAILURE

In the event of an engine or boat system failure and when not in immediate danger, try to troubleshoot or identify the problem before calling for assistance.

See the Troubleshooting section of this manual for additional information.



ACCIDENTS, COLLISIONS AND GIVING ASSISTANCE

A collision or accident may occur when least expected. Formulate a course of action in advance in case of a collision or accident. Keep in mind the following guidelines:

- If an accident or collision occurs involving the boat, locate all passengers first and verify and secure their safety. Check for injuries and provide all passengers with a flotation device.
- After determining that passengers are not in danger, provide assistance to passengers on the other boat.
- Immediately call for help and then assess the damage to the boats. Render necessary assistance to prevent further damage or personal injury.

The USCG requires the owner/operator of a boat involved in an accident to report the incident immediately to the proper marine law enforcement agency for the state in which the accident occurred.

See the Reporting Accidents section of this manual for additional information.

An operator who witnesses or is aware of an accident or collision while boating must report it immediately and provide assistance.

Operators seeing a distress signal or suspecting a boat is in trouble must assume it is a real emergency and render assistance immediately. After determining that a real emergency exists, call for help immediately and then provide assistance to all passengers to ensure their safety.

TOWING ON THE WATER

In situations where an operator is asked to tow or be towed for any reason, assess the situation and try to contact a professional towing service or other emergency assistance first. When encountering a boat in distress, always offer emergency or safety assistance and/or call for assistance for the distressed parties if necessary. Towing or being towed presents an increased risk of personal injury and boat damage.

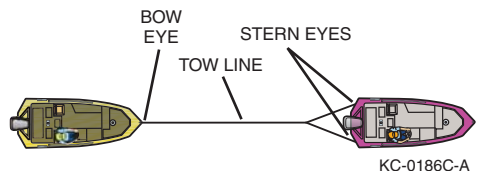

WARNING

Personal Injury Hazard: Use extreme caution when using tow lines and when connecting tow lines to cleats. Death or serious injury could occur if lines and/or cleats fail while they are under extreme tension.



Follow these guidelines when towing or being towed:

- Use extreme caution when throwing weighted lines to a boat in distress. When in rough seas, use a light throwing line with a weight secured on the throwing end and a heavier towing line secured to the other end.
- Never attempt to tow a boat larger or heavier than your own.
- Never attempt to tow a grounded, damaged or capsized boat.
- Use a tow line that is rated at least four times the gross weight of the boat being towed.
- Make sure tow lines are in good condition and are free of damage, cuts or abrasions.
- Attach a tow line to the bow eye on the disabled boat. Never attach a tow line to any point on the disabled boat other than the bow eye.
- Attach the tow line to the stern eyes of the towboat. Wrap the tow line with chafing gear where it rubs against the boat or any corners.
- Leave at least two boat lengths between the boats for adequate movement.
- Never allow anyone to be in line with the tow line. If the line breaks or pulls free, dangerous recoil could occur, resulting in severe injury or death to anyone in its path.
- Adjust the tow line to match wave action. Keep the boats on the crest or in the trough of the waves at the same time. In protected, calm waters, shorten the line for better handling.
- Tow at moderate speed, allowing for adverse wind and wave conditions.
- Have the operator of the towed boat steer with you if possible.
- Have a person on the tow boat watch the disabled vehicle and, if necessary, be available to signal the operator of the disabled boat.

Check with local and state authorities prior to towing for additional regulations and restrictions on towing other boats or equipment.

HURRICANE AND SEVERE WEATHER PREPAREDNESS

If keeping the boat in a region susceptible to hurricanes or severe weather (such as in the Great Lakes), have a well-thought-out plan for the boat long before the season starts. Consider the following:

- Boaters new to the area should talk to neighbors and local officials on what to expect.
- Boaters should talk to the dealer and marina about supplies, equipment and services available.



- Assemble the boat, contacts and insurance information and copy documents for safekeeping.
- If keeping the boat on the water, prepare a hurricane mooring package with extra lines, fenders and chafing protectors, as it is usually the boat owner's responsibility to provide mooring gear in a marina. Plan on doubling the normal lines (bow, stern and spring) and fenders as a minimum. Remember, once a hurricane watch is posted, the local supply of lines and fenders will be quickly depleted.
- Remove electronics, canvas and loose items such as fighting chairs.
- Remove flammable, explosive or hazardous materials.

PROTECTING THE BOAT FROM THEFT

Thefts of boats, propulsion units and electronics are on the rise due to the high values and easy resale. While thieves still target boats on trailers at homes or on lake properties, marinas, storage facilities and dealerships are now being targeted because of the concentration of high-quality outboards and electronics available. Consider the following to make it difficult for thieves:

- Remove expensive electronics or cover with a sturdy, lockable cover.
- Use locking devices on outboard motor mounts and propellers.
- Use security fasteners that require a special tool for removal when mounting devices.
- Survey the marina or storage facility for obvious security lapses. Discuss concerns with personnel or find a new location.
- Talk to neighbors at home or the marina/storage facility and provide them with a cell phone number and other contact information.
- If leaving the boat in the water, install a boat monitoring system with GPS tracking. Many propulsion unit manufacturers now offer this as an option on boats with electronic controls.
- Consult an insurance agent and local authorities for more recommendations.



SECTION

4

EMERGENCIES

This Page Intentionally Left Blank

Section 5

OPERATING IN HAZARDOUS CONDITIONS

Before operating the boat, review *Safety in Section 2*.

SEVERE WEATHER

Getting caught in severe weather can be dangerous and even fatal. Check with local weather stations, the USCG or weather-service broadcasts (162.55 or 162.40 MHz) for the latest conditions. Check the weather not only before you go out on the water, but also periodically while you are on the water. Consult the following websites for weather information:

- www.weather.com
- www.nws.noaa.gov
- www.navcen.uscg.gov

STORM CONDITIONS

Take the following precautions if operating the boat in storm conditions:

- Have all occupants wear life jackets.
- Turn on navigation lights.
- Locate and have inclement weather gear and safety equipment ready.
- Mark or identify the boat's position.
- Close all ports, stow all gear and secure any loose equipment on deck.
- Reduce speed and head for port or a safe, easily reachable place.
- Keep a lookout for debris and obstructions in the water.
- When possible, head into the waves at a 45-degree angle. Allowing high waves to strike the side of the boat may cause it to capsize or swamp.
- If losing power, keep the boat headed into the waves by rigging a sea anchor off the bow.
- If a storm cell with lightning cannot be avoided, lower antenna and take down fishing poles.



FOG CONDITIONS

Avoid operating the boat in foggy weather, if possible. Operators encountering fog conditions should return to port immediately. Also, take the following precautions:

- Reduce speed to a safe speed or idle.
- Take bearings and log the course and speed before the fog sets in. Use of a GPS is recommended.
- Have all occupants wear life jackets.
- Assign lookouts to the bow and stern to keep watch and listen.
- While navigating in fog, sound a five-second blast from the horn or whistle once every two minutes to alert other boaters of your position.
- If it is unsafe to continue navigating the boat, quickly find the best position to anchor. Sound a five-second blast from the horn or whistle once every minute while anchored to alert other boaters of your position.

REDUCED VISIBILITY

Natural environments and inclement weather can cause reduced visibility. Storm condition hazards can be compounded by reduced visibility while on the water. Always use common sense and take safety precautions if operating the boat in reduced visibility conditions.

COLD WEATHER AND COLD OR FROZEN WATER CONDITIONS

Avoid operating the boat in cold water or weather conditions, and never operate in frozen or icy waters. Operating in these conditions significantly increases the risk of serious injury or death. Boating in these conditions can lead to cold-water immersion, shock or hypothermia. Weather conditions may hinder emergency rescue or assistance, and cold weather poses potential problems for onboard equipment, as well as the engine. See the *Engine Operator's Manual* and the equipment manufacturer's instructions for operating in cold weather.

WATER HAZARDS

Every waterway poses hazards that operators must be aware of and avoid. These hazards include shallow water, rocks, tree stumps, sandbars and submerged/semi-submerged cables and pipes. Ask local authorities and other boaters for information and consult a marine chart when boating on unfamiliar waters. As a boat operator, try to avoid all hazards, known and unknown.



AQUATIC VEGETATION/WEEDS

Operating in weeded areas can be hazardous. Aquatic vegetation can be a threat to the boat's drive system. Vegetation and weeds can wrap around the propeller, causing loss of propulsion and steering control. They may also restrict the engine water cooling intake, causing the engine to overheat. Avoid operating in or near vegetation. If restricted because of vegetation, stop the engine. See the *Engine Operator's Manual* for recommendations on the removal of vegetation from the propeller and water cooling intake ports. Be extremely careful and never get into the water when clearing the propeller. Stay out of the water in highly congested vegetative areas, which can severely restrict your mobility and create a life-threatening situation.

NOTICE

Vegetation can sometimes be removed by shifting to NEUTRAL, pausing a moment, then shifting to REVERSE to unwind the vegetation from the propeller.

DAMS AND SPILLWAYS

The waterways around dams and spillways are extremely hazardous. Dams and spillways are subject to rapid water flow changes, and may have floating and sunken debris in the nearby water. These areas are often marked as restricted, and it is best to always stay clear of them.

SHALLOW WATER OPERATION

Operating in shallow water presents a number of hazards. Sandbars in narrow inlets are constantly shifting, making it difficult to mark them with buoys. Sandbars are sometimes indicated by waves as they form into breakers when passing over the sandbar. In coastal areas, tides can affect water level as much as 30 feet (9 meters). Check with local marinas or Coast Guard stations for tide tables and current charts.



MARKERS, WARNINGS AND ADVISORIES

Find out from local authorities if hazards exist in areas where you intend to navigate, and know how these hazards are marked. You must also recognize flag designs that indicate hazards or activities that are present and keep well clear of those areas. Always watch for swimmers and stay clear of all swimming areas, marked or unmarked.



KC-0015C-B

Become familiar with navigation markers, which identify navigable routes and indicate water hazards. Always stay within marked boundaries and steer clear of hazards.

Flags and indicators are markers of potential emergencies and hazards. Become familiar with these flags and indicators. Additionally, understand your responsibilities when operating at these times and in these areas.

BOAT FLAGS

DIVERS FLAG



USED BY RECREATIONAL DIVERS - INDICATES DIVER'S POSITION

ALPHA FLAG



WORLDWIDE VESSELS ENGAGED IN DIVING OPERATIONS - DOES NOT INDICATE DIVER'S POSITION

DISTRESS FLAG



INDICATES FELLOW BOATER IS IN NEED OF ASSISTANCE

SKIER DOWN FLAG









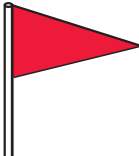

INDICATES SKIER IS DOWN

KCB-0013

Storm warning advisory flags and indicators alert boaters to impending weather conditions. Become familiar with these flags and indicators and understand the potential hazards associated with operating in these conditions.



HARBOR FLAGS AND INDICATORS

DAYTIME WARNING	DESCRIPTION	NIGHTTIME WARNING
	Small Craft Advisory - Winds greater than 18 knots, sustained for two hours or more or hazardous wave conditions. Following a storm, hazardous wave conditions can persist long after the high winds have subsided.	
	Gale Warning - Sustained winds (2 or more hours), of 34-47 knots.	
	Storm Warning - Sustained winds of 48 knots or greater.	
	Hurricane Warning - Forecast winds of 64 knots and above. Displayed only in connection with a hurricane.	

 Actual Signal in red

KC-0371C



SECTION

5

OPERATING IN HAZARDOUS CONDITIONS

This Page Intentionally Left Blank

Section 6

NAVIGATION RULES AND AIDS

Before operating the boat, review *Safety in Section 2*.

The following information outlines basic navigational rules. Boating regulations are enforced by USCG, state and local authorities. You are subject to marine navigation regulations for both federal and state waterways. For more information, contact the USCG, state and local marine authorities. The navigational rules for U.S. waterways can be found in the “Navigational Rules” publication. This publication can be found at most marine supply stores, or you may contact the USCG or visit:

www.navcen.uscg.gov to view or download the publication.

Any boat 39 feet (12 meters) or longer must have a copy of the “Navigational Rules” publication on board at all times. Failure to have this document on board can result in penalties and/or fines.

RIGHT-OF-WAY

Boats with less maneuverability have right-of-way over more agile boats. You must stay clear of a boat with right-of-way. Examples of boats with right-of-way are:

- Boats aground or not under command
- Boats with restricted maneuverability
- Boats engaged in fishing
- Non-motor boats (having no power propulsion), i.e., rowboats, paddle boats, canoes and sailboats

Small pleasure boats must yield right-of-way to large commercial boats in narrow channels. A boat with right-of-way is sometimes referred to as the privileged boat.

THE GENERAL PRUDENTIAL RULE

The general prudential rule regarding right-of-way is if a collision appears unavoidable, neither boat has right-of-way. Both boats must act to avoid collision.

NAVIGATIONAL LIGHTS AND NIGHT OPERATION

Navigational lights alert other boats to your presence and course, especially when operating at night or in restricted visibility conditions.



Regulations require that navigational lights be clearly lit and properly displayed at all times between sunset and sunrise, and always when operating in reduced visibility. Where applicable, lights must appear on the sides, stern, masthead and all-around positions.

All navigational rules apply at night, but speed is restricted on many waterways. Night boaters must operate at a slow, safe speed and stay clear of all boats, regardless of which boat has right-of-way.

Protect your night vision by avoiding bright lights. If possible, have a passenger help keep watch for other boats, water hazards and aids to navigation.

The size, speed and direction of other vessels are determined at night by white, green and red running lights.

- A green light indicates the starboard side of the boat. Generally, if you see a green light on another boat, you have the right-of-way. Hold your course.
- A red light indicates the port side of the boat. Generally, if you see a red light on another boat, they have right-of-way and you must yield your course.

AUDIBLE SIGNALS

It is not necessary to sound a signal every time a boat is nearby. It is typical for commercial boat operators to signal their intention, using a whistle, horn or bell, to avoid potentially confusing or hazardous situations. Privileged boat operators customarily signal first, then the yielding boat operators return the same signal to acknowledge they understand and will comply. Use the danger signal (five or more short, rapid blasts) if intent is not clear.

Use the following signal blasts early enough so other boaters notice and understand them:

AUDIBLE DISTRESS SIGNAL	DEFINITION
One long blast	Warning signal (coming out of slip or passing astern)
One short blast	Pass on port side
Two short blasts	Pass on starboard side
Three short blasts	Engine(s) in reverse
Five or more short blasts	Danger signal



OVERTAKING / PASSING

The boat overtaking or passing must yield right-of-way to the boat being passed. The overtaking boat must make any adjustments necessary to keep out of the way of the boat being passed. The boat being passed has the right-of-way and must hold its course and speed.

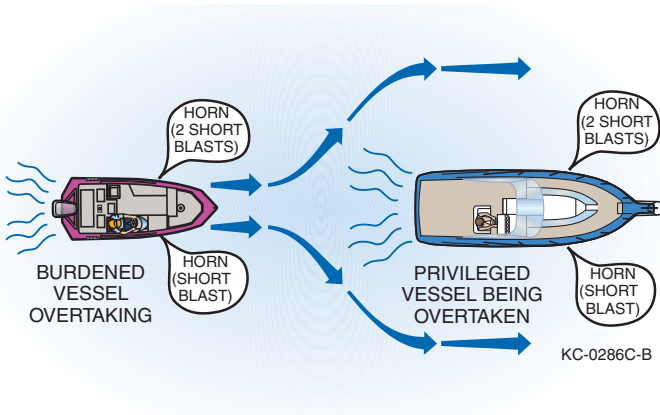



MEETING HEAD-ON

When two boats meet head-on, neither boat has the right-of-way. Both boats should decrease speed, turn to the right and pass port to port. If, however, both boats are on the left side of a channel, each vessel should sound two short horn blasts and pass starboard to starboard.

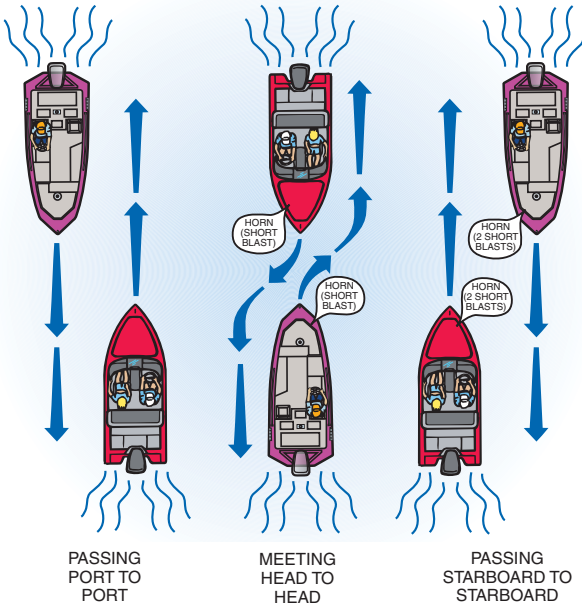

KC-0086C-A



CROSSING

In crossing situations, the boat to the right from the 12 o'clock to the 4 o'clock position has the right-of-way and must hold course and speed. The boat without right-of-way must yield and pass to the stern of the privileged boat. Boats going up and down a river have the right-of-way over boats crossing the river.

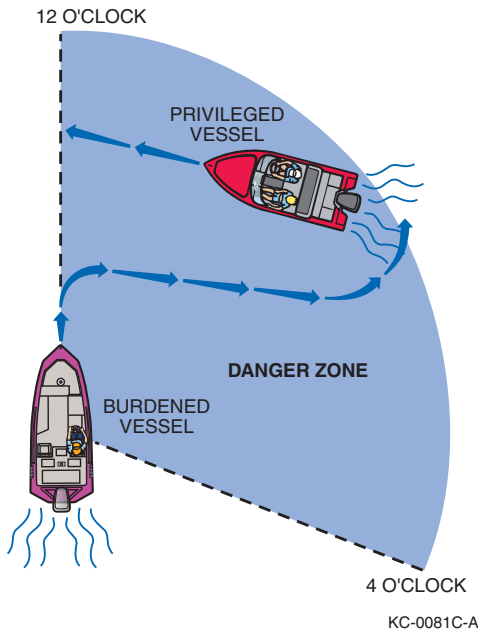



AIDS TO NAVIGATION

Learn to recognize the different buoys and day markers; they are the signposts of the waterways. The United States Aids to Navigation System (USATONS) is the primary marking system used on inland water, coastal waters and rivers. This system is maintained by the USCG.

Navigational aids are designed and placed accordingly to help you navigate safely on the water. Learn to recognize the different buoys and day markers.

The following information is based on the USATONS. For further information, contact the USCG and state and local marine authorities. Also visit www.uscg.mil for buoyage system information.

The USATONS uses buoys, beacons and minor lights as markers.

NEVER tie or anchor to a navigational aid. This action is unlawful and dangerous to you, your boat and other boaters.

NEVER move or damage a navigational aid. This action is unlawful and dangerous for other boaters.

BUOYS

Most anchored floating markers are generally referred to as buoys. Buoys have many uses and color schemes, and can vary in size and shape. The most commonly used buoy colors are white, red, green, yellow and black. Buoys may be unlighted or lighted. Some are audible; others have both an audible and a visual signal. Lights, bells and horns on buoys aid in night boating or poor visibility conditions. Buoys with unique light-flashing characteristics are identified on nautical charts with the specific flashing pattern.

Become familiar with the specific buoys used in the waters where you are boating. Contact local authorities for specific information and/or navigational aid charts for your waterways.

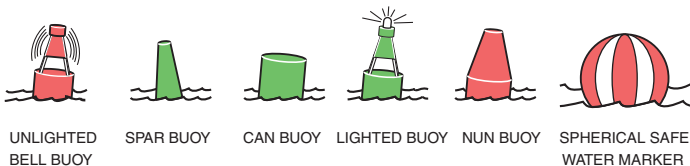

UNLIGHTED
BELL BUOY

SPAR BUOY

CAN BUOY

LIGHTED BUOY

NUN BUOY

SPHERICAL SAFE
WATER MARKER

KC-0052C-B



MOORING BUOYS

The only buoys you are permitted to moor to are mooring buoys. Mooring buoys are white with a blue horizontal stripe. Mooring to a navigation buoy, regulatory markers or lateral markers is illegal.

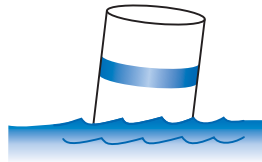

WHITE WITH BLUE BAND
MAY SHOW WHITE REFLECTOR OR LIGHT

KC-0020C-A

DAYMARKS / DAYBOARDS

Daymarks or dayboards are fixed visual markers in the water. The markers are commonly attached to a post or piling and are sometimes accompanied by a light. Daymarks are either red or green and are usually



STARBOARD
DAY
MARKER

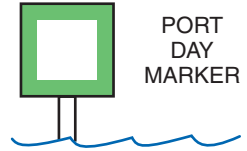

PORT
DAY
MARKER

KC-0021C-A

triangular- or square-shaped, though their shapes can vary. Daymarks often display numbers, which act as navigation guides. Red daymarks are usually triangular and sometimes show an odd number. Green daymarks are usually square and sometimes show an even number. The numbers on the markers are sequential and increase from seaward.

LIGHTS AND LIGHTED STRUCTURES

Maneuvering a boat at night can be dangerous and confusing. To aid boaters with navigation and to warn of hazards, the USCG and state and local authorities maintain a variety of light structures. Some light structures are equipped with radio beacons, radar reflectors and/or fog signals.

Minor Lights

Minor lights are colored according to the buoyage marking system in use. They are similar to lighted buoys, except they are usually higher and on more stable platforms to increase visibility. Most minor lights are part of a series to mark a channel, river, or harbor and fairways.



Range Lights

Range lights are usually visible in one direction and help a boat operator navigate safely. Steering a course to keep range lights arranged in a line (one on top of the other) will help guide a boat through a channel.

RANGE LIGHTS

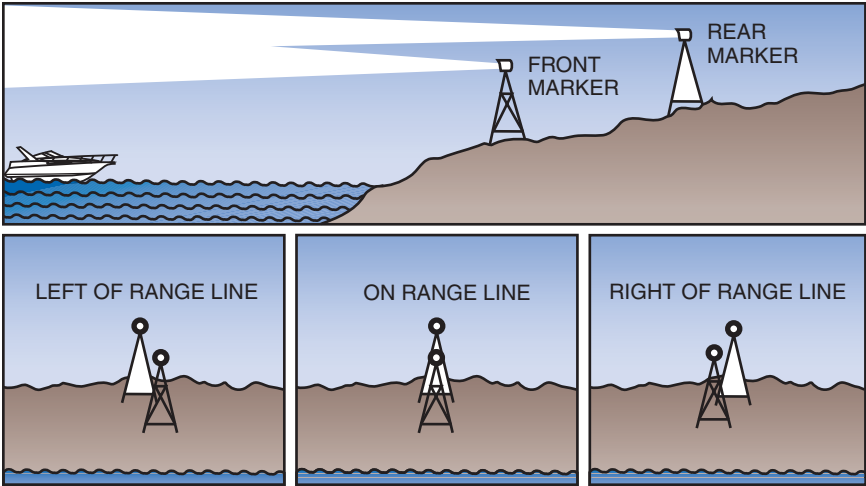

KC-0022C-A

Lighthouses

Lighthouses can be found at harbor entrances, prominent headlands, isolated danger areas and along the coasts. These striped or patterned structures have unique flashing signals, which help boaters identify them.

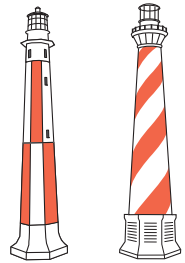

KC-0023C-B



MARKERS

Seven (7) types of markers are used to assist the boat operator:

- Regulatory
- Range
- Special
- Lateral
- Safe Water
- Preferred Channel
- Isolated Danger

Regulatory Markers

Regulatory markers are used to display information or indicate danger. Regulatory markers can be fixed visual markers or anchored floating buoys.

Fixed visual markers are usually white with orange geometric shapes that display information. Anchored floating buoys are white cylinder-shaped buoys with orange bands at the top and orange geometric shapes that may display information.

Following are the various orange geometric shapes used on these markers:

- Diamond – Indicates danger
- Diamond with cross marks inside – Indicates that a boater must keep away
- Circle – Indicates a controlled area or speed limit
- Square – Displays important information



DANGER



BOATS
KEEP OUT



CONTROLLED
AREA



INFORMATION

KC-0244C-A

Range Markers

Range markers have many color schemes, may have numbers or letters and may be lighted or unlighted. They are placed in pairs within close distance of each other. They are commonly used in channels to guide boats safely through the center or safe line of navigation. Keep range markers visually in line with each other while navigating the waterway to avoid obstacles or other invisible dangers.



Special Markers

Special markers are yellow and come in various styles and shapes. Lighted and unlighted daymarks and buoys vary in function. Many are used to display information and navigational direction rules. The most common special markers are those used in intercoastal waterways. Contact your state and local authorities for more information on special markers used in your boating area.

Lateral Markers

Lateral markers are used to mark the sides of navigable channels. They can be buoys, daymarks or minor lights, and are red and green in color. They can be lighted or unlighted and may or may not have numbers.

The basic nautical rule of lateral markers is the phrase “Red, Right, Returning.”

The term “sea” generally refers to the ocean or a large body of water. “Seaward” refers to traveling from the sea or a large body of water inland or to a smaller body of water.

When traveling seaward – keep red markers to your port (left) and green markers to your starboard (right).

When returning from seaward – keep red markers to your starboard (right) and green markers to your port (left).

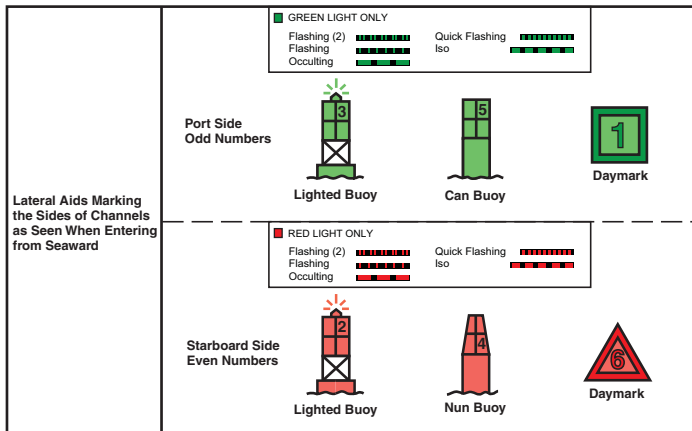

KC-0054C-A

NAVIGATION RULES AND AIDS



Safe Water Markers

Fairways and mid-channels may be marked with safe water markers or buoys. These markers indicate safe water all around. Safe water markers are red and white with vertical stripes, and are round or have a red spherical top mark.

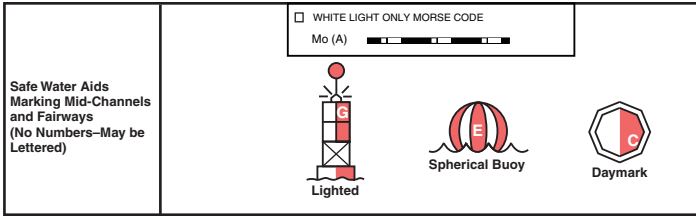

KC-0055C-A

Preferred Channel Markers

Obstructions, channel junctions and preferred channels are marked with red and green horizontally striped can and nun-style buoys. The top band color indicates the preferred path to take. Use these markers in the same manner as lateral markers to follow preferred channels.

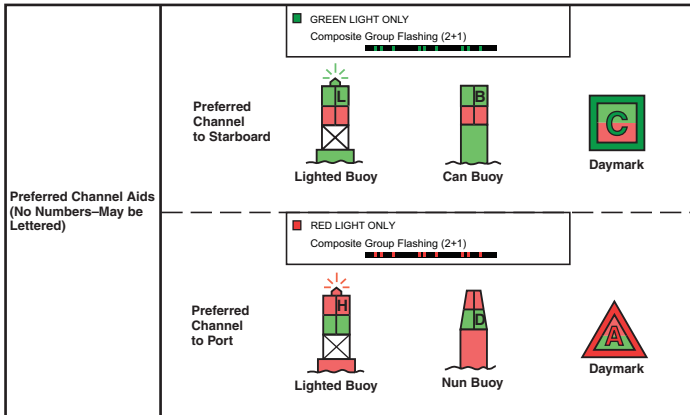

KC-0056C-A



Isolated Danger Markers

Isolated danger markers indicate an isolated danger which may be passed on all sides. These markers are black with one or more broad horizontal red bands and are equipped with a top mark of two black spheres, one above the other. On inland waters, a buoy with alternating vertical black and white stripes may be used to indicate that an obstruction or other danger exists between the buoy and the nearest shore. Do not pass between the buoy and the shore.

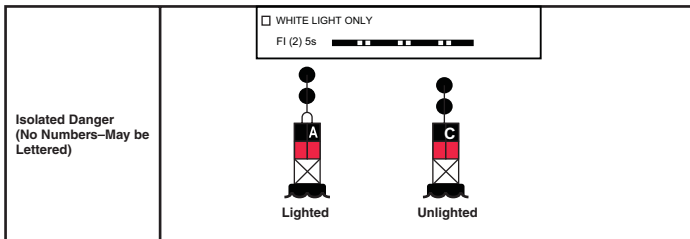

KC-0057C-A

Other Special Signs and Markers

Various signs and markers are used throughout U.S. waterways for different purposes. In Florida, special signs are used to warn of “manatee” areas. These signs help to control speed and/or restrict areas from boating to conserve this endangered species. As a boat owner and operator, be aware of special information and markers on the waterways. Contact your state and local authorities for more information on local restricted or controlled areas and their markers.

Section 7

OPERATING THE BOAT

Before operating the boat, review *Safety in Section 2*.



WARNING

Control Hazard: Certain actions can cause you to lose control of the boat:

- *When accelerating the boat in the forward direction, the bow can rise and restrict visibility. Observe for obstacles and people before accelerating.*
- *The rotational thrust of the propeller under rapid acceleration can create high steering torque and rapidly change the direction of steering, causing loss of control.*
- *Do not trim the engine out too far or the boat may begin to “porpoise” (bounce up and down). Porpoising reduces control and visibility.*
- *Improper use of trim tabs or moving them down at high speeds can cause loss of control.*
- *If you lose control of the boat, pull back on the throttle and trim in at the same time.*

BEFORE GETTING UNDERWAY

SAFETY EQUIPMENT

Federal and local laws require certain safety equipment to be on board at all times. Responsible boaters carry additional equipment in case of emergency.

FLOAT PLAN

Complete a float plan before departure and leave it with a reliable person who is aware of your intentions while on the water. In case of emergency or if you do not return as planned, this information can be helpful to the USCG or others in rescuing or contacting you. There are several float plan apps that make it easy to fill out and email the plan. For more information on float plans or to download a float plan form, go to:

<http://www.floatplan.uscgauz.info>



PRE-DEPARTURE SAFETY CHECKLIST

The following checks are essential to safe boating and must be performed before starting the engine or getting underway. Perform these checks every time you operate the boat so they become routine.

Never launch the boat or leave the safety of the dock if any problem is found during the pre-departure safety check. A problem could lead to an accident during the outing, causing severe injury or death. Have any problems corrected before proceeding:

- Check the current and forecasted weather reports, as well as wind and water conditions.
- Make sure the operator is qualified to operate the boat and does not use drugs or alcohol while at the helm.
- Make sure all required safety equipment is on board.
- Make all passengers aware of safety procedures.
- File a float plan.
- Have all required documents on board.
- Have all maps or navigational charts for the intended destination on board.
- Be sure all passengers are properly seated.
- Be sure the boat is not overloaded.
- Check the engine emergency stop switch lanyard for proper installation and operation.
- Be sure the fire extinguisher is fully charged.
- Check bilge drain plugs for proper installation.
- Be sure all water has been pumped from the bilge area.
- Have plenty of emergency food and water on board.
- Check the bilge blower (if equipped) for proper operation, and be sure no fumes are present in the bilge area.
- Be sure all required equipment is on board (mooring lines, anchor lines, tool kit, etc.).
- Be sure you have enough fuel for the return trip.
- Check all compartments for fuel fumes.
- Check that no fuel, oil or water is leaking or has leaked into the bilge compartment.
- Check all hoses and connections for leakage and damage.
- Check the hull and propeller for damage.
- Check the engine cooling water intake pickup for blockage.



- Check that batteries are fully charged and the battery terminals are clean and tight.
- Check the electrical systems and navigation lights for proper operation.
- Be sure no person or obstacle is near the propeller.
- Check that the throttle/shift control is in the NEUTRAL position.
- Check the steering system for proper operation.
- Check that all required maintenance has been performed.

BOARDING

Helpful guidelines when boarding a boat:

- Always step, rather than jump, into a boat.
- Avoid stepping on fiberglass or other potentially slippery surfaces.
- Always board one person at a time.
- Never board while carrying gear. Set the gear on the dock, board the boat and then pick up the gear.
- It is courteous to always ask for permission to board so the owner/operator is aware of your presence on the boat.

See the Using the Boarding Platform/Ladder section of this manual for re-boarding the boat from the water.



BOAT LOADING

The safety and performance of the boat depends on load, weight and the distribution of each.

The person/load capacity is determined by the USCG. A capacity plate is usually located within clear visibility of the boat operator or helm area. The capacity plate indicates limits for loading the boat, which are enforceable by law.

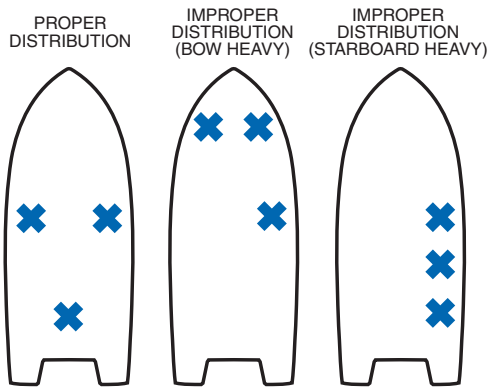

KC-0333-A



WARNING

Sinking Hazard: NEVER exceed the USCG certified maximum capacities under any circumstances. Exceeding the limitations stated on the capacity plate can cause the boat to sink or the passengers and/or operator to drown, resulting in death or serious injury.

- Board passengers one at a time and distribute them equally to maintain equal buoyancy of the boat.
- Distribute weight equally from port to starboard and fore to aft. The shifting of weight may be required when underway to maintain an efficient trim position for optimum performance.
- Stow and secure all loose gear in stowage areas to prevent load shifting.
- Do not stow gear on top of safety equipment; safety equipment must be quickly accessible.
- In adverse weather, reduce the load in the boat. Person and load capacity ratings are calculated for normal boating conditions.



FUELING

FUEL MANAGEMENT

Use the “one-third” rule for fuel management. Use one-third of the fuel to reach your destination, one-third to return and one-third as reserve fuel.

FUEL SUPPLIERS

Refuel only at approved suppliers such as marina fuel docks or automotive fuel service stations. Approved suppliers have safeguards in place to lessen the likelihood of static discharge. Use only containers and funnels approved for use with gasoline fuels. See the Before Refueling section of this manual for additional information.

STATIC ELECTRICITY AND THE FUEL SYSTEM

The boat’s built-in fuel tank has a bonding system that protects it from creating and discharging static electricity. The boat must be in contact with the water or on its trailer when refueling to complete the bonding system.

If the bonding system is not complete, an electrostatic spark may occur.

⚠ WARNING *Fire/Explosion Hazard: An electrostatic spark can ignite fuel vapors, causing a fire and/or explosion.*

Use extreme caution when filling the fuel system. In addition:

- Remove portable fuel tanks from the boat and place them on the ground to fill. The fuel tank must be properly grounded before refueling.
- Do not refuel a built-in fuel tank if the boat is suspended from a sling or another type of boat lift system. Suspending the boat from the water interrupts its bonding system. Using a portable fuel tank to refuel the boat while it is suspended may cause an electrostatic spark.



FUEL (GASOLINE)

Fuel for marine gasoline-only engines must be carefully selected to avoid fines and possible catastrophic engine damage not covered under warranty. It is illegal for any person to tamper with emissions control devices such as the fuel system, and it is also illegal for any person to mis-fuel a marine gasoline-only engine with a blend of more than 10% ethanol.



KCB-0004

While it is always preferable to use fuel that does not contain ethanol (usually labeled as “marine” or “recreational”), most marine engines are designed to tolerate E10 (10% maximum ethanol) fuel as long as the fuel meets the engine manufacturer’s octane requirements. When using fuel containing ethanol, buy fuel in smaller quantities that will be consumed during a weekend of boating. Fuel degrades quickly and the engine operates better on fresh fuel. Use marine fuel stabilizer to treat and reduce degradation of any remaining fuel.



KCB-0005

Do not use octane boosters or other fuel additives. Purchase fuel from a quality supplier selling high volumes to ensure the fuel is fresh. For more information go to: www.toptiergas.com/licensedbrands/

NOTICE

Fuels that are blended to contain more than 10% ethanol may damage the engine, oil system or fuel system and should not be used in marine engines. Fuels that contain more than 10% ethanol can corrode metal parts, deteriorate rubber and plastic, or weaken gaskets. Damages caused by the use of fuels that contain more than 10% ethanol or fuels that do not meet engine manufacturer octane requirements are not covered by your warranty.



BEFORE REFUELING



WARNING

Fire/Explosion Hazard: Gasoline is extremely flammable and highly explosive under certain conditions. Be sure to check the fuel hoses and connectors for leaking and deterioration before fueling and on a monthly basis.

- Refuel the tanks only in a well-lighted area.
- Know where the fire extinguishers are.
- Stop all engines, motors and appliances before refueling. Keep the engine compartment blower on if equipped.
- Do not smoke or allow open flames or sparks nearby, within 50 feet (15 meters), of the fueling area.
- If equipped, close all doors, windows, hatches and ports.
- Determine the amount of fuel required to fill the tanks. Do not overfill the fuel tanks. Allow for at least a 2% expansion of fuel when refueling. If the fuel temperature is 32°F (0°C) or lower, allow at least 6% for fuel expansion.

FUELING

The fuel filler on boats with built-in tanks is usually located on the gunwale. The fuel tank is equipped with either a shutoff valve or antisiphon valve. The shutoff valve requires you to manually turn the fuel valve, while the antisiphon valve operates automatically. Because gasoline fumes are heavier than air, they will sink to the lowest part of your boat, such as the bilge. Always evacuate fumes with the bilge blower (if equipped) before attempting to start the engine.

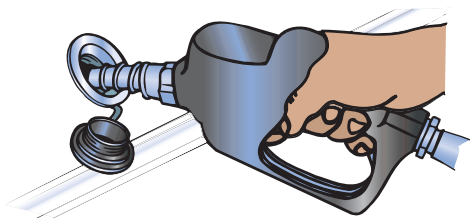

KC-0027C-A

NOTICE

To prevent unwarranted engine damage, refer to the Engine Operator's Manual for recommended fuel and oil specifications.



REFUELING BUILT-IN FUEL TANKS

Maintain contact between the fuel nozzle and the fill pipe at all times, before and during refueling, to prevent an electrostatic spark. If it's necessary to use a funnel, use a metal funnel. Do not use a plastic funnel. Do not fill built-in tanks from unapproved portable containers.

AFTER REFUELING

- Close the fuel fill cap thoroughly.
- Wipe up any spilled fuel completely. Dispose of rags properly onshore.
- Open all doors, windows, hatches and ports to ventilate all spaces. Check for fuel vapors before starting any engines or appliances.
- If equipped, operate the blower for a minimum of four minutes before starting the engine.

OUTBOARD ENGINE FUELING CONSIDERATIONS

If the boat is powered with an outboard engine, one or more of the following may also apply:

- Smaller two or four-stroke outboards may have a portable fuel tank. If so, the tank must be removed from the boat and placed on the ground to be filled. Fill portable fuel tanks onshore in the outdoors within an enclosed area.
- After refueling, install portable fuel tanks to the boat using straps or other fuel tank restraining system. Store portable fuel tanks in a well-ventilated area, away from heat and open flames. If equipped, close the filler cap vent screw.
- Two-stroke outboards mix oil with the fuel to be burned during combustion. During fueling and refilling on a two-stroke outboard, check the separate oil tank inside the boat or under the engine cover.
- Two-stroke outboard oil must meet the engine manufacturer's specification.

GETTING UNDERWAY

The following basic boat maneuvering and operation principles do not cover all conditions or situations you may encounter during operation. It is important for you and anyone else operating the boat to have certified instruction before operating the boat.



Always advise all passengers on board of your steering, stopping and accelerating intentions. Brief passengers on:

- Safety equipment location and operation
- Basic boat operation
- Radio operation
- Re-boarding procedure
- Man overboard procedure
- Emergency procedure
- Hazardous weather procedure
- Docking procedure
- Fueling procedure

Be sure all passengers are properly seated in designated seating positions and not riding on the bow, bow pulpit, deck, gunwale or rear sun deck while underway. Passengers must use caution when riding in the bow. Move to the aft passenger seats during rough water operation or if visibility is restricted.

STARTING

The following information is intended as a basic guideline only and may not apply to your specific engine or controls. See the *Engine Operator's Manual* or control manufacturer's information for instructions on starting and operating the engine, adjustments and maintenance.

- Secure the boat to the dock before starting the engine.
- Check that the throttle is in the NEUTRAL position.
- Turn the battery selector switch to the appropriate ON position.
- Attach the engine emergency stop switch lanyard to the boat operator.
- Check that all passengers are seated properly.
- Position the lower drive power trim to the full DOWN position.
- Start the engine.

STEERING

Steering a boat is very different from steering an automobile. Steering and maneuvering a boat is far more difficult and requires time and practice to master.

When steering a boat, it is important to understand the causes and effects of turning. Since both thrust and steering are at the stern of the boat, the stern will push away from the direction the steering wheel (helm) or tiller arm is turned. The boat seems to skid across the water while turning, which feels very different from an automobile making a turn.



Steering in reverse has its own challenges. Practice forward and reverse steering to gain comfort and to feel in control of the boat in any steering situation.

Be prepared for wind and current while steering the boat. Steering in wind or water currents is difficult and requires skill to be able to anticipate and compensate for these effects.

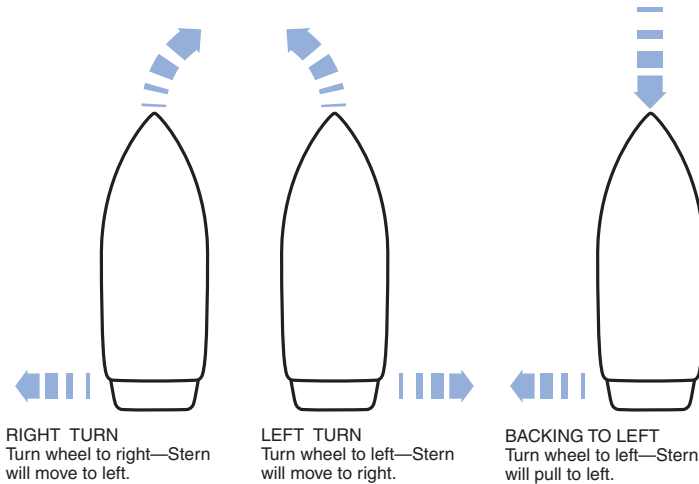

KC-0199-A

Rotational thrust of the propeller is an aspect most single propeller-driven boats share and needs to be compensated for at slow speeds. During rotational thrust, torque is transmitted to the helm and may cause the boat to drift either port or starboard when moving forward at a slow speed. Rotational thrust usually goes unnoticed at high speeds. While moving forward at a slow speed, constant helm corrections are usually necessary to maintain a straight course.

Twin-engine and dual-prop boats usually compensate for rotational thrust of the propellers by using one counterrotating drive with a counterrotating propeller, and one standard clockwise-rotating drive and propeller to reduce the effects of steering torque at all boat speeds.



STOPPING

A boat does not have brakes. Controlling the boat to a stop and while stopped are important skills that must be learned. Reverse thrust is commonly used to slow and stop a boat. The continued momentum of a boat will vary according to the boat design, load and speed. You must also consider and learn to compensate for the effects of wind and current. Stopping in wind or water currents is difficult and requires skill to be able to anticipate and compensate for these effects.

- To stop or slow forward motion, always gradually return the throttle(s) to the slow IDLE position, pause and shift into NEUTRAL, then pause and shift into REVERSE.



WARNING

Control Hazard: Gradually return the throttle(s) to the slow IDLE position. Failure to do so can cause loss of boat control and engine propulsion system damage.

- If the boat has been driven for a long period of time at high speed, allow the engine a two- to three-minute cool-down period at low idle in NEUTRAL.
- Turn the ignition key to the OFF position.

NOTICE

Never pull the lanyard from the engine emergency stop switch for normal shutdown. Doing so may impair your ability to restart the engine quickly.

- Avoid collisions; at high speeds the boat will require more time and distance to stop or slow.
- The proper use of trim tabs and outdrive trim angle is important when slowing to a stop. Qualified local boating authorities can provide proper instruction in slowing and stopping your boat.



SHIFTING

The following information is a basic guideline only and may not apply to the specific shift control. See the *Engine Operator's Manual* or control manufacturer's information for the shift control operation, adjustment and maintenance.

- Most side-mounted throttle and shift controls have a neutral detent lock that must be released before shifting from NEUTRAL.
- Always use a brisk and decisive movement when shifting into or out of gear.
- Always pause in NEUTRAL before shifting from FORWARD to REVERSE, or REVERSE to FORWARD. Most throttle and shift controls have a detent position for NEUTRAL, FORWARD and REVERSE engagement positions. These detent positions are important; when shifting into and out of gear, always pause in these positions.
- Never shift into REVERSE while your boat is in FORWARD gear when traveling at any speed above idle.
- Always keep the shift control clean and clear of obstructions.

ACCELERATING AND RUNNING UNDERWAY

You must understand the boat's equipment and controls in order to drive and control the boat in a forward direction at all speeds and in all conditions. Learning to drive and control the boat can be challenging; take this matter seriously and spend plenty of time practicing.

The phrase "on plane" is commonly used when referring to the running angle of a boat in forward motion. When a boat is "on plane," its hull is usually running level or almost level with the water's surface, which is considered level. The level "plane" of the water's surface is the most efficient angle to run in. This basically means that the boat is running on top of the water and not plowing through it.

Factors to consider when accelerating a boat forward and running at the most efficient planing angle are:

- Boat design
- Hull type and condition
- Boat load and distribution of weight
- Engine capability and condition
- Propeller type, size and condition
- Outdrive and boat power trim equipment and condition



Because all boats are different and vary in design, purpose and load, planing angles and characteristics will vary among all boats. Become familiar with the boat's characteristics and obtain qualified assistance.

The following guidelines provide a basic understanding of forward acceleration and operating on plane while underway:

- Always look in front of and around you before proceeding. Avoid collisions before accelerating; be aware and stay clear of people and obstacles in the water.
- Always advise all passengers on board of your intention to accelerate and get underway.
- Stow and fasten all loose gear.
- Make sure the engine emergency stop switch lanyard is connected to the operator.
- If equipped, adjust the boat trim tabs up or to a neutral position with the hull.
- If equipped, adjust the engine power trim to the full-in position.
- Shift from NEUTRAL into FORWARD detent idle position.
- Adjust steering to the direction of travel.
- Using a controlled and constant motion, move the throttle control forward.

**WARNING**

Control Hazard: When accelerating forward, the bow can rise and restrict visibility. Never remove your hand from the steering wheel. The rotational thrust of the propeller under rapid acceleration can create high steering torque and rapidly change the direction of steering, causing loss of control.

- As the boat begins to move, the bow will rise and the boat will tend to plow through the water. As acceleration increases, the boat will begin to plane or level out within a few seconds. If it will not plane to a near-level position and has sufficient horsepower, slowly reduce the throttle back to the FORWARD detent idle position. Recheck the load distribution and trim equipment position to determine the cause.
- Once the boat is on plane, the steering torque will diminish; however, never remove your hands from the helm while underway. While running at a planed position, you will notice greater throttle response and steering control as you continue to accelerate or achieve the most comfortable and safe speed for the conditions. You can achieve better performance, control and running efficiency using the engine's power trim and the boat's trim tabs, if equipped.



- Be aware of the wake you create and anticipate the effect it will have on others. During acceleration, deceleration and at speeds other than on plane, a heavy wake is usually created. You are responsible for the boat's wake and any damage or injury it causes.
- Obey no-wake areas and speed-controlled areas.
- Stay clear of or at a safe distance from other boats.
- Avoid collisions; at high speeds the boat will require more time and distance to stop or slow.

CHECKS DURING AND AFTER OPERATION

- Check gauges frequently for signs of abnormal conditions.
- Check that controls operate smoothly.
- Check for excessive vibration.

POWER TRIM AND TILT

The following information is a basic guideline only and may not apply to your specific power tilt unit. See the *Engine Operator's Manual* for information on your power tilt operation, adjustment and maintenance.

The engine's power tilt generally operates in conjunction with the power trim system, which is commonly called power trim and tilt. This system allows you to raise and lower the lower drive unit and propeller to adjust trim (the planing and running angle of the boat while underway) and tilt (used to position the lower drive unit up beyond the power trim range used for trailering, launching or beaching). Never use power tilt while the engine is running.

POWER TRIM OPERATION

The following information is a basic guideline only and may not apply to your specific power trim unit. See the *Engine Operator's Manual* for information on your power trim operation, adjustment and maintenance.

The engine's power trim allows you to raise and lower the lower drive unit and propeller to adjust the planing and running angle of the boat while underway.

Boat trim adjustment while underway greatly affects boat performance and efficiency. During normal operation while underway at speed, trim the boat to the best possible position to reduce the wetted surface of the hull. With less boat in the water, both speed and fuel economy increase. Adjust systems with manual trim adjustment for best overall operation for the load and conditions. Engines with power trim allow for continuous adjustment for best results.



Adjust the power trim by using a switch at the helm area or on the throttle control. Trim gauges are available in most applications to provide a visual gauge-to-trim position. Most gauges indicate trim position between UP (out, away from the transom) and DOWN (in, closer to the transom).

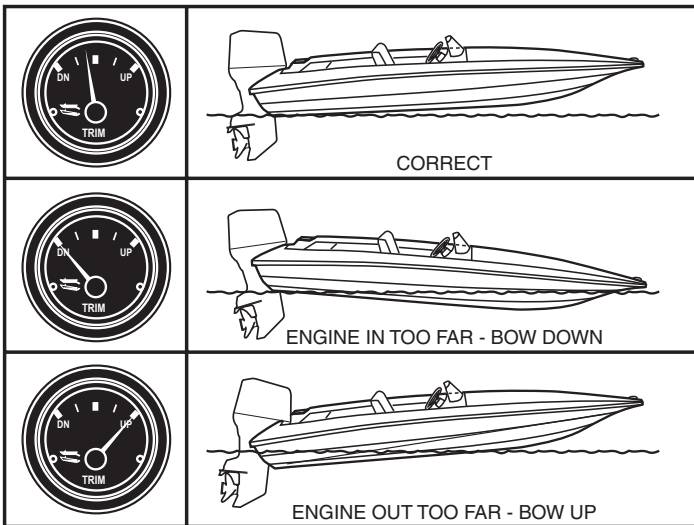

KC-0126-A

General effects of power trim underway:

Trim in too far (closer to the transom):

- Speed decreases.
- Fuel economy decreases.
- Boat may handle and steer poorly.
- Boat will have difficulty achieving a proper running, planing position.

Trim out too far (away from the transom):

- Steering torque increases.
- Speed decreases.
- Fuel economy decreases.
- Boat may handle and steer poorly.
- Boat will bounce or porpoise.
- Engine RPM increases.



- Propeller may ventilate as it nears the surface of the water and slip excessively as it pulls air from the surface. This will cause engine RPM to rapidly rise.
- Boat will have difficulty getting on plane from an idle position.



WARNING *Control Hazard: Do not trim the engine out too far or you may lose control of the boat. If you lose control of the boat, pull back on the throttle and trim in at the same time.*

See the Operating the Boat section of this manual for more details.

General power trim operation guidelines:

- When getting on plane from an idle position, start with the trim full in. As the throttle position increases, the boat speed will increase and drive the bow up. As acceleration proceeds, the bow will start to come down. When the bow starts to fall and the boat begins to plane, slowly start to trim out.
- Trimming out while underway generally causes the boat to rise up and plane. The boat begins accelerating without adjusting the throttle as less of the boat is dragging in the water. Trimming up causes the engine RPM to increase. It is very important to watch the engine tachometer to keep it at or near full throttle operating range and not to exceed the engine's wide-open throttle operation range. See the *Engine Operator's Manual* for the engine's wide-open throttle operation range.
- To find the optimum trim position while underway, run the boat at a stable planed angle with the least possible amount of the hull in the water. The boat reaches optimum trim position when it is not porpoising or plowing excess water.

High-speed operation on smooth water provides stability, but you must maintain control by using quick reactions and adjustments. Know your limits and stay within them. Keep one hand on the steering wheel and the other on the throttle controls at all times.

Constant adjustments are necessary for rapidly changing conditions. Small inputs of throttle and steering are exaggerated at high speeds. Depending on the speed, keep watch well ahead so that you have enough time to react.

If the boat has trim tabs, you can achieve further boat trim adjustment by using the trim tabs in conjunction with the engine power trim equipment.



DOCKING

Practice leaving and approaching the dock to become familiar with the procedures.

Helpful guidelines when departing from the dock:

- Make sure you have sufficient space to maneuver the boat away from the dock, other boats and any other obstacles that may hinder your departure.
- Always allow sufficient clearance to the stern for the engine to clear any obstructions.
- Be aware of other boat traffic, wind and water conditions before departing.
- Make sure the engine is started and you have boat movement under control before casting off any mooring lines.
- Always proceed slowly when departing from a dock.

Helpful guidelines when docking:

- Make sure you have sufficient space to maneuver your boat around the dock, other boats and any other obstacles that may hinder your approach.
- Be aware of other boat traffic, wind and water conditions on your approach.
- Approach from a direction against the wind or current.
- When possible, approach slowly from a 45-degree angle and then steer parallel to the dock.
- Have fenders, dock lines and assistance ready.



WARNING

Personal Injury Hazard: Never use your hand, arm or any other part of your body to attempt to keep the boat from hitting the dock. The boat could push against the dock, causing severe injury.

- If possible, throw a mooring line to a person on the dock and have that person secure the bow. With the bow secure, swing the stern in with the engine or pull it in using a boat hook or the stern line.
- Tie off the bow and then the stern.
- Use bow and stern dock lines, as well as spring lines, for additional security.
- Use fenders to protect the boat from damage.
- Never attach a dock line to a point or part of the boat that is not designed to withstand the stress and the weight of the boat.
- If planning on docking the boat for a long period of time, use chafing protectors on the lines to protect the boat's finish.



- Leave some slack in the lines to allow for wave movement or tidal action if applicable.

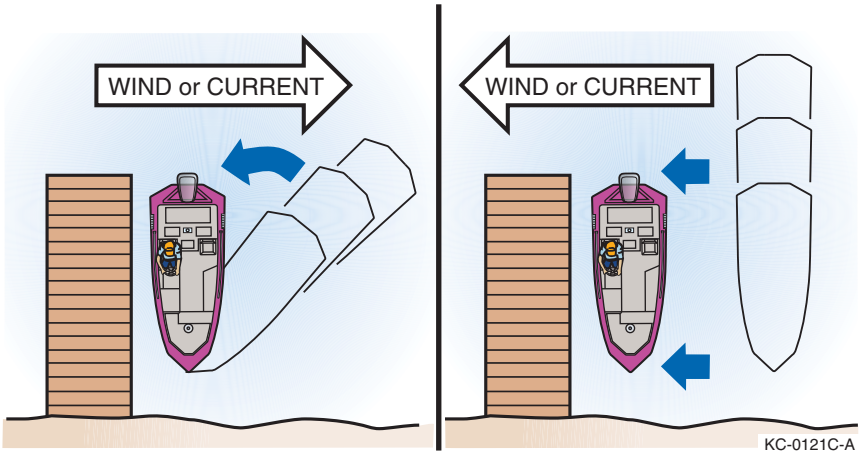

MOORING

Because mooring configurations vary, consult with other experienced boaters or the boat dealer for recommendations on properly mooring the boat. Always moor the boat securely to prevent personal injury or property damage.

Helpful guidelines when mooring:

- Each mooring line must be of the appropriate strength, material and type to safely secure your boat when moored.
- Each mooring line must be longer than the length of the boat.
- Use bow and stern mooring lines, as well as spring lines, for additional security.
- Use fenders to protect the boat from damage.
- When possible, tie up with the bow facing into the wind or current.
- Never attach a mooring line to a point or part of your boat that is not designed to withstand the stress and the weight of the boat.
- Only use the bow eye, stern eyes and other cleats or attachment points that have been approved for mooring.
- If you plan on mooring the boat for a long period of time, use chafing protectors on lines to protect the boat's finish.



- Leave some slack in the lines to allow for wave movement or tidal action if applicable.

ANCHORS AND ANCHORING

Anchors are available for various applications and come in many sizes, types and shapes. Boat weight and size are primary factors in choosing an anchor. When selecting an anchor, consult other qualified boaters familiar with the waters or the boat dealer.

Anchor line is constructed from various materials and is available in many diameters and types. The anchor rode for recreational boats consists of the anchor line connected to a length of chain attached to the anchor. Consult with the boat dealer for a recommendation on appropriate lines for the boat anchor and application.

For most applications, anchor line length should be at least six to seven times longer than the depth of the water in which you are anchoring. Always have plenty of additional anchor line on board. If anchoring in tidal waters, consider a rode chain about the length of the boat and increase the total anchor line length to ten times the depth of the water at low tide.

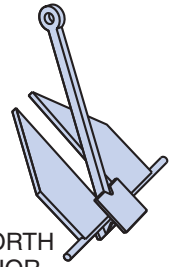

DANFORTH
ANCHOR

KC-0042-A

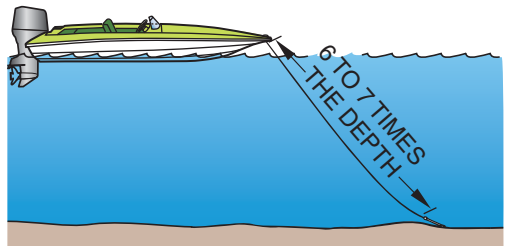

KC-0146C-A



WARNING

Sinking Hazard: ALWAYS anchor from the bow; NEVER anchor from the stern. A small amount of current will make a boat unsteady. A strong current can pull a boat anchored by the stern under the water and keep it there.

Helpful guidelines when anchoring:

- Make sure the anchor line is tied to the anchor. Tie the other end of the line to the forward cleat or bow eye.
- Head the boat into the wind or current over the spot where you want to lower the anchor.



- Stop the boat before lowering the anchor.
- Slowly lower the anchor until it hits bottom.
- Allow the boat to back away, keeping tension on the line.
- Release at least six to seven times as much line as the depth of the water.
- Secure the anchor line to the bow cleat or eye.
- Firmly pull on the line to make sure the anchor is holding.
- Occasionally check your position against the shoreline. If the anchor is dragging and the boat is drifting, reset the anchor.

Helpful guidelines when weighing (pulling in) the anchor:

- Start the engine(s).
- If necessary, move forward until enough tension is off the anchor line to allow for retrieval of the anchor. Avoid running over the anchor line; retrieve the line as you approach the anchor.
- Once the anchor line is straight up and down, lift the anchor from the bottom.
- If the anchor is stuck, attach the anchor line to the bow cleat so it is tight. The up-and-down motion of the bow from wave action may loosen the anchor from the bottom. If the anchor remains stuck, let out a few more feet of line and attach it to the bow cleat. While keeping tension on the line, slowly maneuver your boat around the anchor to help loosen it. Avoid running over the anchor line.
- Always stow and secure the anchor and line before departing.



LINES AND KNOTS

Mooring, anchor and other nautical lines are constructed from many different types of materials, and are available in many diameters and styles. Consult with your local marine supply store for a recommendation of appropriate lines for the boat and application. Commonly used mooring lines are constructed of a high-quality synthetic material in a double-braided configuration and usually have eye splices on at least one end.

Learn and become familiar with tying and using knots. Knowing how to use knots and lines properly can prevent personal injury and property damage.

Practice tying lines to docks, cleats and anchors, and connecting two lines together. Consult other qualified boaters or the boat dealer, or visit the local bookstore, library or the Internet for information on the proper use of nautical lines and knots. The following illustrations represent a few examples of securing mooring lines.

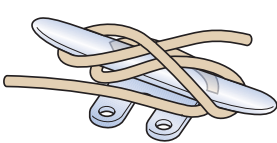

Cleating an open line

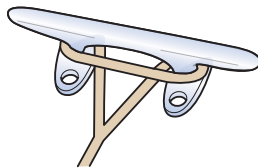

Cleating an eye-spliced line

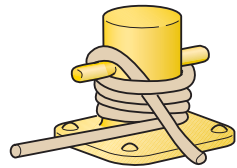

Securing to a dock bitt

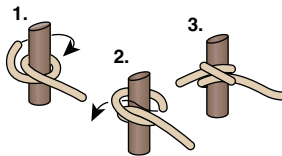

Securing load line
(clove hitch)

A "double half hitch" should always accompany a "clove hitch" on the load line.

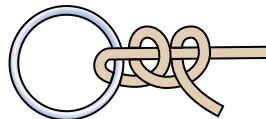

Securing load line
(double half hitch)

KCB-0010



SECTION

7

OPERATING THE BOAT

This Page Intentionally Left Blank

Section 8

TRAILERING AND LAUNCHING

Before using the trailer, review *Safety in Section 2*.

LEGAL CONSIDERATIONS

The following information is intended as a basic guideline only. See the *Trailer Operator's Manual* for information on operation, adjustments and maintenance.

Before using the trailer, contact your state's Department of Motor Vehicles (and that of other states through which you may be traveling) for information on trailering regulations. Trailer regulations vary widely from state to state, and it is your responsibility to be in compliance with all regulations when trailering the boat.

Regulations include, but are not limited to, trailer registration, licensing, width, height, length, lights, safety chains, tie-downs, hitch type, weight capacity, brakes, spare wheels, vehicle mirrors and gross vehicle weight.

TRAILER CLASSIFICATION

Trailers are separated into four classes based on the Gross Vehicle Weight Rating (GVWR):

TRAILER CLASS	GVWR
Class One	under 2000 lb (907 kg)
Class Two	over 2000 lb (907 kg) and under 3500 lb (1588 kg)
Class Three	over 3500 lb (1588 kg) and under 5000 lb (2268 kg)
Class Four	over 5000 lb (2268 kg)

TRAILER TYPE

Trailers are designed for many applications and can vary in style. To prevent damage to the boat and/or personal injury, always use the appropriate trailer for proper support of the boat. Contact the dealer for more information.

TRAILER GROSS VEHICLE WEIGHT RATING

All trailers must display a Gross Vehicle Weight Rating (GVWR) decal, which shows the load-carrying capacity plus the weight of the trailer. The total weight of the boat (fully loaded with fuel, batteries, water, etc.), engine, gear and trailer must never exceed the GVWR.

TOWING VEHICLE

The towing vehicle must be able to safely pull the full trailer and boat load. Never pull a trailer load that exceeds the vehicle's towing capacity; you risk losing control of the trailer and/or vehicle. Before trailering, always check the *Vehicle Operator's Manual* for maximum towing/trailering load specifications and maximum gross vehicle weight specifications that include the fully loaded trailer.

VEHICLE TOWING HITCH

The towing vehicle must be able to safely pull the full trailer and boat load. The vehicle must have a towing hitch that is capable of safely handling the trailering load and tongue weight of the trailer.

Hitches are designed for many applications and can vary in style. Use professional assistance when selecting the correct hitch and hitch ball for the towing application.

 **WARNING** *Control Hazard: A vehicle hitch that is underrated or improperly installed can lead to loss of control of the trailer and/or vehicle. Never use a hitch that is not rated to pull the maximum weight of the trailering load or that is not rated for the maximum tongue weight that the trailering load applies.*

Hitches are divided into classes that specify the trailer's gross trailer weight and maximum tongue weight for each class.

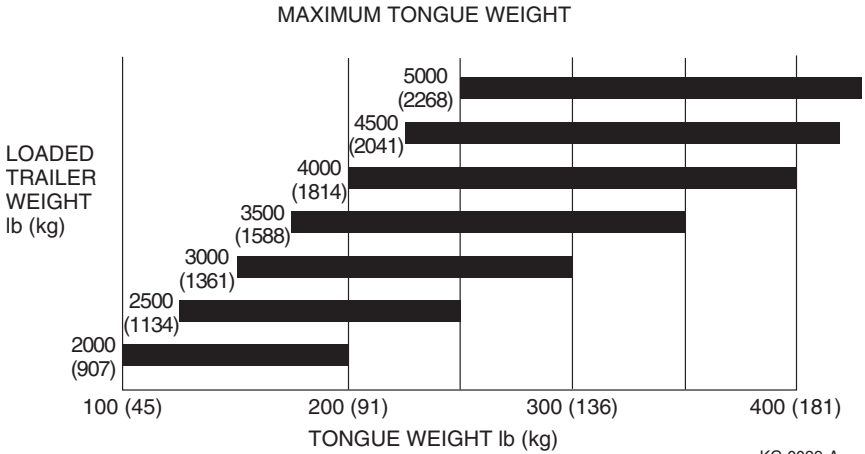

HITCH BALL AND TRAILER COUPLER

Most boat trailers have a coupler that connects to a hitch ball attached to the towing vehicle's hitch. The trailer hitch coupler must always match the size of the hitch ball. The correct hitch ball diameter for the coupler is usually marked on the trailer coupler.

⚠ WARNING *Control Hazard: Never use a hitch ball size or rating that does not match the trailer coupler specifications. Using an improper size or rated hitch ball can lead to loss of control of the trailer and/or vehicle.*

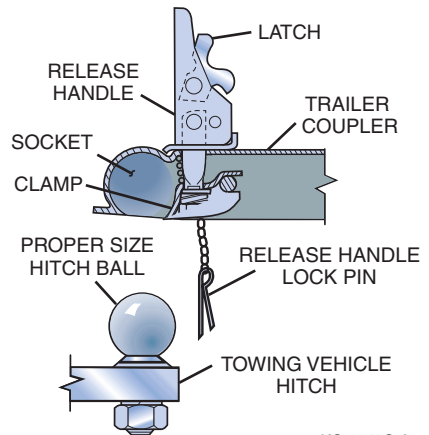



Trailer hitch balls are sized and rated for use based on the trailer GVWR:

TRAILER CLASS	GVWR	HITCH BALL DIAMETER SIZE
Class One	under 2000 lb (907 kg)	1-7/8 in. diameter size
Class Two	over 2000 lb (907 kg) and under 3500 lb (1588 kg)	2 in. diameter size
Class Three	over 3500 lb (1588 kg) and under 5000 lb (2268 kg)	2 in. diameter size
Class Four	over 5000 lb (2268 kg)	2-5/16 in. diameter size

SAFETY CHAINS

The boat trailer's safety chains prevent the trailer from completely detaching from the towing vehicle when underway. Connect the chains to the vehicle's hitch or frame and crisscross the chains under the trailer tongue to prevent the tongue from dropping to the road if the trailer separates from the hitch ball. Rig the chains as tight as possible with enough slack to permit full-free turning. Safety chains must be rated at the same or greater weight capacity as the trailer's GVWR.

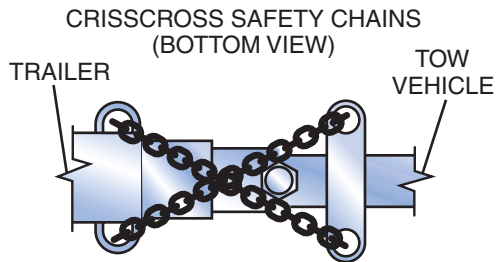

KC-0045C-A

Never allow the chains to drag on the ground when trailering.

Attach the chains properly and securely between the towing vehicle and trailer before trailering.



TRAILER BRAKES

In some states, any trailer with a GVWR of 1500 lb (680 kg) or more is required to have trailer brakes.

Check with your state and local authorities for more information.

The three basic types of trailer brakes are electric, hydraulic surge and air-actuated. If the trailer is equipped with brakes, see the *Trailer Operator's Manual* for more information on operation, adjustments and maintenance.

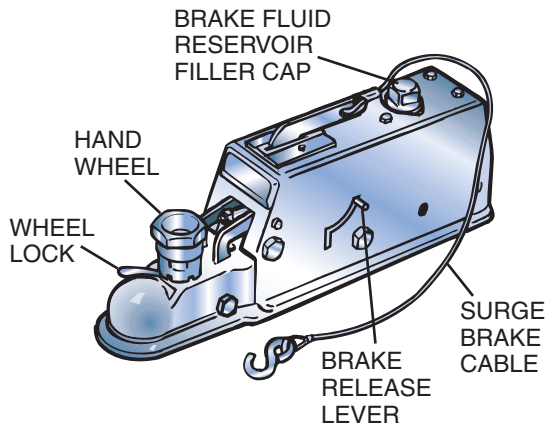

KC-0044C-B

5-PIN WIRING CONNECTOR

Some trailers equipped with surge brakes may utilize a 5-pin wiring connector. These trailers use an electric solenoid valve that allows brake fluid to bypass back to the reservoir while in REVERSE. The solenoid is usually connected to the reverse lights on the tow vehicle to ensure the brakes only bypass in REVERSE. The fifth pin is for deactivating the brakes when backing up, and is required to be connected to the vehicle's power when backing up.



TRAILERING GUIDELINES

Follow these guidelines when trailering:

- Before driving, make sure the vehicle maintenance and trailer maintenance are current. This is very important because towing puts additional stress on the tow vehicle.
- Make sure the wheel lug nuts/bolts on the tow vehicle and trailer are tightened to the correct torque.
- Be sure the hitch, coupler, draw bar and other equipment that connect the trailer and the tow vehicle are properly secured and adjusted.
- Make sure all running lights, brake lights, turn signals and hazard lights are working.
- Verify that the brakes on the tow vehicle and trailer are operating correctly.
- Maintain a safe speed as regulated by the trailering laws of the state where you are traveling.
- Check the trailer and vehicle brakes for proper operation and fluid level prior to departure.
- Check the trailer for damage prior to departure.
- Make sure the hitch ball and trailer coupler are the same size and bolts and nuts are tightly secured.
- The coupler must be completely over the ball, and the latching mechanism must be locked down.
- Make sure the safety chains are properly crisscrossed and connected. They should not touch the road but should have enough slack to make turns. If the ball were to break, the trailer would follow in a straight line and prevent the coupler from dragging on the road. Make sure the trailer emergency brake cable or chain is also installed to the tow vehicle frame.
- Ensure the breakaway system lanyard is connected to the tow vehicle and not to the safety chains or ball mount.

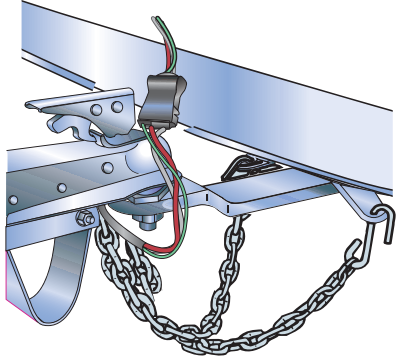

KC-0046C-A

NOTE — Make sure the towing vehicle and trailer are in compliance with all state and local laws. Contact your state motor vehicle bureau for laws governing the towing of trailers.

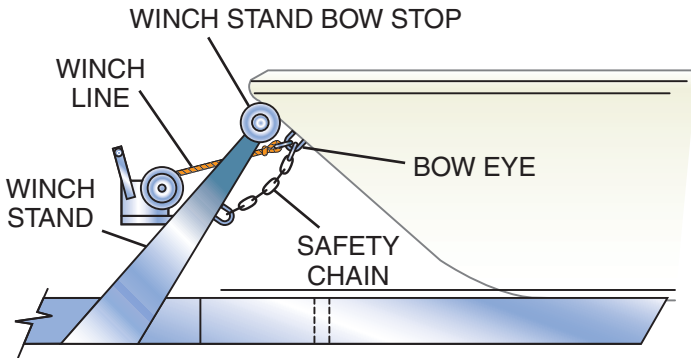

KC-0047C-A

- Once the trailer is secured to the vehicle hitch, stow the trailer jack or lift so that it will not hit the ground.
- Check and correct tire pressure on the tow vehicle and trailer, including the spare tire. Under-inflated tires heat up rapidly and may cause tire damage or failure. The proper tire pressure is listed on the trailer certification plate.
- Check trailer wheel bearings before each trip.
- Secure the stern of the boat to the trailer from the stern eyes.
- Fasten the bow of the boat to the trailer with the bow winch line connected to the bow eye and bow safety chains.
- If travel conditions require, use an additional tie-down strap across the rear of your boat from side to side to further secure the stern.
- Check all strapping material for wear.
- Check that the wiring is properly connected. It should not touch the road but should be loose enough to make turns without disconnecting or damaging the wires.
- Too much or too little tongue weight makes steering difficult and causes the tow vehicle to sway. Put approximately 5% to 10% of boat and trailer weight on the tongue.
- Drive with the vehicle and trailer running lights on.
- Check load distribution to make sure the tow vehicle and trailer are properly balanced front to back and side to side.
- Check that all items are securely fastened on and in the trailer.
- Be sure the trailer jack, tongue support and any attached stabilizers are raised and locked in place.



TRAILERING AND LAUNCHING

- Check side-view mirrors and rearview mirrors for good visibility.
- Check routes and restrictions on bridges and tunnels.
- Keep wheel chocks and jack stands on hand.
- Side curtains, backdrop, aft curtains, convertible tops and detachable windshields are not designed to stay on boats at highway speeds. Before towing, take down the convertible top, side curtains, back cover and detachable windshield, if equipped.
- Remove any covers that are not designed to stay on boats at highway speeds.
- Carry a spare tire and wheel for both the trailer and the towing vehicle, along with tools to change them.
- See the *Engine Operator's Manual* for engine-related trailering information. Continuous road shocks may fatigue the boat's steering system.
- Tie outboard motors in place so they will not tilt or turn from road shock.
- On extended trips, carry spare wheel bearings, seals and races.
- While traveling, check the wheel hubs every time you stop. If the hub feels abnormally hot, inspect the bearing before continuing your trip.
- Carry a fire extinguisher in the vehicle.
- Turn carefully while towing a trailer; additional space and distance are needed.
- Drive slowly over railroad tracks or rough roads.
- While trailering the boat from lake to lake, boaters may unknowingly introduce a foreign aquatic species from one lake to the next. Thoroughly clean the boat below the waterline, remove all weeds and algae and drain the bilge and livewells before launching it in a new body of water.

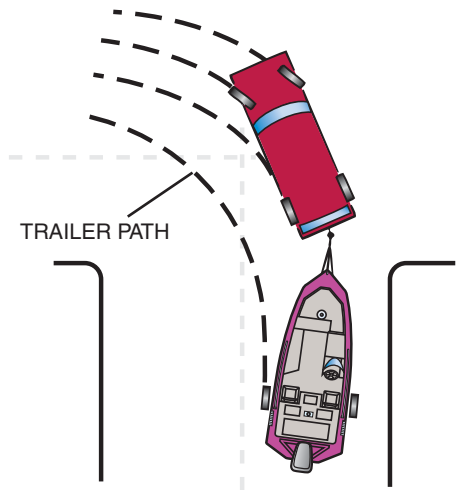

KC-0288C-A



BACKING UP

If you have never towed a trailer before, take time to practice and become comfortable with backing up the boat and trailer. Situations can arise in traffic, or when launching, that will require you to be able to back up the trailer safely.

Follow these guidelines when backing a trailer:

- Back slowly and make small steering adjustments.
- Turn the car wheels in the direction opposite where you want the trailer to go.
- After the trailer begins moving, turn the car to follow it.
- Have a second person assist you with audible and hand signals.

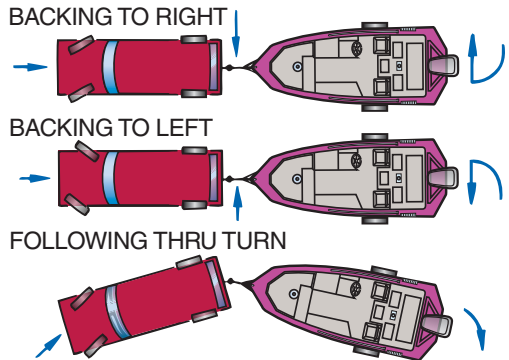

KC-0163C-A

LAUNCHING

Before launching, inspect the launch ramp for any problems that may hinder launching or make launching unsafe. Ramps can be slick and dangerous to drive or walk on, and may have unseen drop-offs beneath the water that would pose a safety hazard. Always be aware of water conditions and the effects of the wind when launching.

Before launching, inspect the boat and trailer for damage. Do not launch if you detect damage or find that the engine or propeller is not in good operating condition. Have any repairs made before launching.

Use courtesy when preparing the boat for launching by preparing away from the ramp on level ground before proceeding to the launch ramp.

When launching the boat on the trailer, have two or more people assist you. Since all launches are different, the following procedures are intended as guidelines only:

- Verify that the vehicle's brakes, including the parking brake, are in proper working order.
- Make sure the trailer is securely fastened to the vehicle.
- Remove the boat cover, if equipped.



TRAILERING AND LAUNCHING

- Check that the bilge drain plug is in place and all other plugs that allow water to leak into the boat are in place.
- Remove all tie-downs from the boat.
- Attach the bow and stern docking lines.
- Attach boat fenders if necessary.
- Disconnect the trailer's light harness from the car.
- If applicable, trim or tilt the engine/outdrive up to avoid damage.
- Make sure the bow winch and strap are securely locked and fastened.
- Make sure the bow winch safety chains, if equipped, are in place.
- Make sure all required documentation and safety equipment are on board.
- Verify that batteries are fully charged and in good condition.
- Check fuel level; add fuel if necessary.
- Always launch with the help of another person.
- Make sure there is no one on the ramp behind the boat.
- Keep the trailer/vehicle combination as straight as possible and at 90 degrees to the shoreline.
- Back slowly down the ramp until the transom of the boat is a few inches in the water; then stop the vehicle.
- Stop the vehicle and shift into PARK (automatic transmission) or REVERSE (manual transmission). Apply the brakes and/or parking brake. If possible, use wheel blocks.
- Position the mooring lines within reach of the dock.
- Disconnect the bow winch strap and safety chains, if equipped, from the bow eye.
- Manually back the boat clear of and off the trailer into the water and secure to the dock using mooring lines.
- Remove any wheel blocks and release the vehicle brakes. Pull the trailer slowly out of the water, and secure and park in a designated area.
- Board the boat.
- Lower the engine/outdrive, if applicable.
- Run the bilge blowers as required, if equipped.
- See the *Engine Operator's Manual* for starting procedures.
- Remove dock lines from the dock and proceed slowly away from the dock.



LOADING GUIDELINES

Follow these guidelines while loading the boat onto the trailer:

- When loading the boat on the trailer, have two or more people assist you.
- Stop, turn off the engine and secure it to the dock with dock lines at a position clear from where the trailer will be in the water.
- If applicable, trim or tilt the engine/outdrive up to avoid damage.
- Verify that the vehicle's brakes, including the parking brake, are in proper working order.
- Disconnect the trailer's light harness from the tow vehicle.
- Make sure the trailer is securely fastened to the vehicle.
- Back the trailer slowly down the ramp until it is positioned so that the boat can be loaded.
- Stop the vehicle and shift into PARK (automatic transmission) or REVERSE (manual transmission). Apply the brakes and/or parking brake. If possible, use wheel blocks.
- Position the mooring lines within reach of the dock.
- Manually position the boat onto the trailer using mooring lines. Make sure it is centered on the supports of the trailer.
- Position the bow eye into the bow stop and connect and secure the bow winch strap and safety chains, if equipped, to the bow eye.
- Secure the mooring lines inside the boat.
- Remove any wheel blocks and release the vehicle brakes. Slowly pull the trailer and boat up the ramp.
- Secure the transom to the trailer.
- Prepare for trailering as necessary.

REPORTING SAFETY DEFECTS

If you believe that your boat trailer has a defect which could cause a crash or could cause injury or death, you should immediately inform the National Highway Traffic Safety Administration (NHTSA) in addition to notifying the trailer manufacturer.

If NHTSA receives similar complaints, it may open an investigation, and if it finds that a safety defect exists in a group of trailers, it may order a recall and remedy campaign. However, NHTSA cannot become involved in individual problems between you, your dealer or the boat manufacturer.

To contact NHTSA, you may call the Vehicle Safety Hotline toll-free at 1-888-327-4236 (TTY: 1-800-424-9153); go to <https://nhtsa.safercar.gov>; or write to Administrator, NHTSA, 1200 New Jersey Avenue SE, Washington, DC 20590. You can also obtain other information about motor vehicle safety from <https://www.safercar.gov>

Section 9

BOAT FEATURES AND OPTIONS

Before operating any systems within this section, review *Safety in Section 2*.

The boat may be equipped with a variety of systems to operate the boat and to provide other conveniences you may need while on the water. The following basic and typical information may not apply to your specific application. All of the boat's systems may not be covered in this section. See the *Equipment Manufacturer's Operator's Manual* for specific details.

Regularly inspect and maintain all components and systems to prevent unexpected hazards due to worn or faulty components. Be sure to replace components and hardware with marine-grade parts.

⚠ WARNING *Fire/Explosion Hazard: Never use parts not specified for marine use to replace marine-grade parts. Using non-marine specified parts in a marine environment may result in a fire and/or explosion.*

FUEL SYSTEM

The basic fuel systems consist of one or more fuel tanks, tank vents, level sensor and gauge, lines, pumps and valves.

Each tank has an antisiphon valve to prevent fuel from leaking out of the tank should a break occur in the system at a point other than the tank. Some models are also equipped with a fuel shutoff valve at each tank to stop fuel flow from the tank. It is recommended that fuel shutoff valves be closed during long periods of inactivity or storage. If equipped with multiple tanks, the system also includes a fuel tank selection valve for individual tank selection and a fuel manifold. The manifold is usually located in the engine compartment and contains a series of fuel feed valves for controlling fuel flow/shutoff to the engines. The fuel valves can be used to help maintain even weight distribution in the fuel tanks for proper boat load distribution or to shut off contaminated fuel from the system. Refer to the boat and *Engine Operator's Manual* for specific fuel system information and service information.

ENGINE LUBRICATION SYSTEM

Depending on engine type, the boat may feature one of several engine lubrication systems. Many small-to-mid-range two-cycle outboards are lubricated by oil mixed directly with the gasoline in the fuel tank, while other two-cycle outboards may be equipped with an oil injection system. In each system, the oil is consumed as the engine runs. Oil injection systems include a separate reservoir for oil containment and an oil pump or combination fuel/oil pump that supplies oil to the fuel system for engine lubrication. Four-cycle outboards and sterndrive engines, like automotive, use a sump system where the engine oil is contained in the engine. See the *Engine Operator's Manual* for engine oil recommendations and information.

ENGINE COOLING SYSTEM

Most outboard engines are cooled by using raw water to transfer heat from the engine and then returning the raw water to the sea/lake. A raw water pickup and screen on the lower drive unit allows water into the engine. A pump then circulates the water to cool the engine. Be sure to periodically inspect the intake screen and clear it of any debris which could obstruct water flow into the engine. A continuous discharge of water from the cooling water check port while the engine is running is a visual indication that the engine's cooling system is operating properly.

NOTICE

To prevent engine damage, DO NOT run it with the lower drive unit raw water intake above the waterline or out of the water.

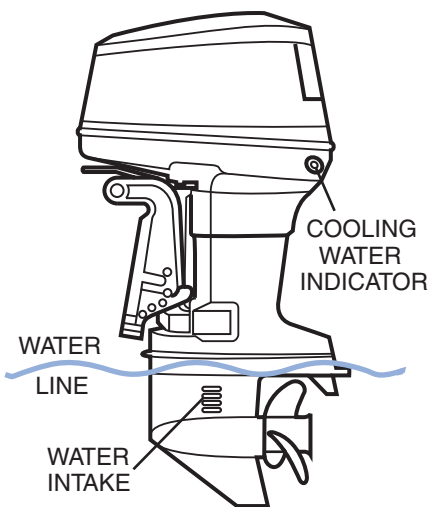

KC-0192-B



STEERING SYSTEM

⚠ WARNING *Control Hazard: Be sure to inspect the outboard's steering system for damage after striking an underwater object. Stop immediately to inspect for damage that may result in loss of steering control.*

Steering systems vary in type and operation. The most common steering systems are mechanical, power-assisted and hydraulically operated.

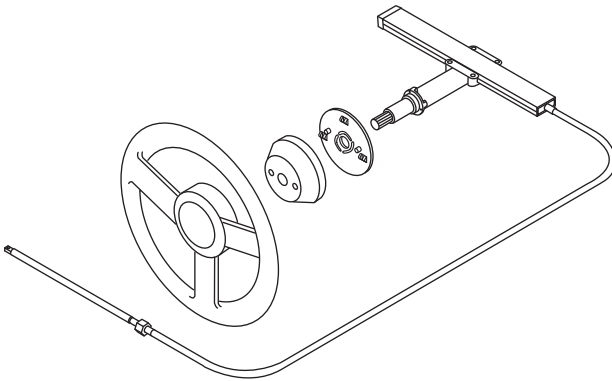

KC-0268-A



Boat steering controls are not self-centering. Always keep a secure grip on the steering wheel to maintain full boat control.

Mechanical steering helm controls transfer the rotary motion of the steering wheel to linear cable motion, which pushes or pulls the engine's steering arm. Some boats are equipped with two mechanical cables to provide positive steering control and additional safety in case one cable fails.

Power-assisted mechanical systems use hydraulic force to assist the manual rotary motion of the helm's movement, providing easier steering for the operator.

Hydraulic systems use hydraulic pressure from a pump connected to the helm to move hydraulic fluid through hoses, and then to move hydraulic cylinders connected to the engine's steering arm. A reservoir, either separate or integral to the pump, holds extra fluid and maintains a pressure head to prevent air from entering the system.

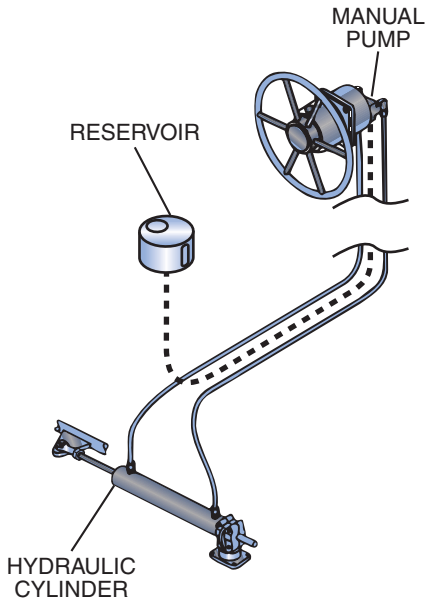

KC-0170-A

SHIFT AND THROTTLE CONTROLS

Knowing how to operate the shift and throttle controls of the boat is essential for safe and proper operation.

The following basic and typical information may not apply to your specific shift control. See the *Engine Operator's Manual* or control manufacturer's instructions for information on your throttle and shift control operation, adjustment and maintenance.

BOAT FEATURES AND OPTIONS



SINGLE-LEVER CONTROLS - SINGLE OR TWIN ENGINE

Single-lever controls operate both the gear shift and the throttle for one engine with one control lever. Single-lever controls can be used on single- or twin-engine boats.

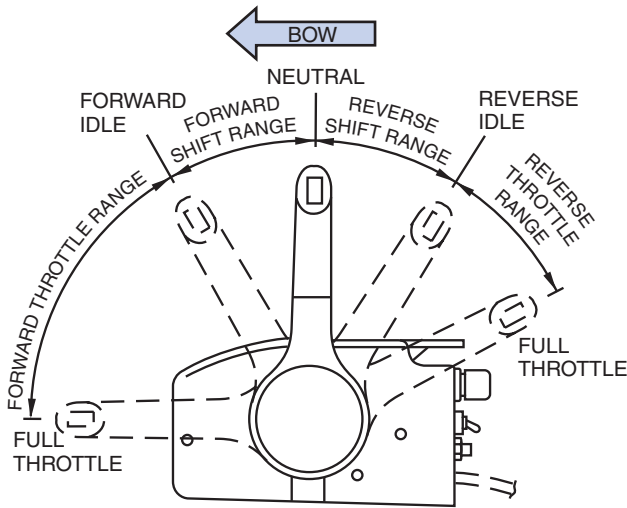

KC-0092-A

NEUTRAL - The lever is detented in the NEUTRAL position (center of travel) for starting; the neutral safety switch allows starting in this position only. For engine warm-up, a separate lever or button on the control is used to disengage the shift cable and allow the throttle to advance only while the transmission remains in NEUTRAL.

FORWARD - Release the detent lock to allow shifting to the FORWARD position. Moving the lever into the first 15 degrees of travel (toward the bow or up) positions the control in the FORWARD detent IDLE position. Advancing the lever beyond 15 degrees allows throttle increase in FORWARD.

REVERSE - Release the detent lock to allow shifting to the REVERSE position. Moving the lever into the first 15 degrees of travel (toward the stern or down) positions the control in the REVERSE detent idle position. Advancing the lever beyond 15 degrees allows throttle increase in REVERSE.



CONTROL OPERATION GUIDELINES

⚠ WARNING *Control Hazard: Improperly maintained controls are hazardous and may cause sudden loss of control. Make sure all shift/throttle hardware and cables are regularly inspected and maintained. Improper maintenance may result in a loss of control.*

- Side mount throttle and shift controls have a neutral detent locking lever that must be released before shifting from NEUTRAL.
- Always use a brisk and decisive movement when shifting into or out of gear.
- Always pause in NEUTRAL before shifting from FORWARD to REVERSE, or REVERSE to FORWARD. Most throttle and shift controls have a detent position for NEUTRAL, FORWARD and REVERSE engagement positions. Engine damage may occur if you rapidly shift into gear without pausing in these detent positions or allowing the engine RPM to lower into the approved shifting range.
- When traveling at high speed, never shift into REVERSE while your boat is in FORWARD gear.
- Always keep the shift control clean and clear of obstructions.

NOTICE *All shift and throttle controls are equipped with a safety switch for start-in-gear prevention. Place the control in the NEUTRAL position before you attempt to start the engine.*

- Never attempt to shift when the engine is not running.

ELECTRICAL SYSTEM

Boats may be equipped with one or two types of electrical systems: Direct Current (DC) and Alternating Current (AC).

Most boats use a battery-powered direct current (DC) system; some boats also use a generator or shore-powered alternating current (AC) system. Most systems have a main load panel which serves as the main distribution panel.



DC SYSTEM

⚠ WARNING *Fire/Explosion Hazard: Always use caution when operating and maintaining the DC electrical system. Fire or explosion may result from improper use of the DC electrical system.*

Most boats use a 12-volt common negative ground DC system. DC systems are usually the primary electric supply for lights, pumps, blowers, engine starting, etc.

Boats require at least one battery per engine. Multiple-battery systems consist of a cranking battery for each engine and additional batteries that supply auxiliary power to DC electrical circuits.

Battery switches control battery power distribution and disconnect the batteries from the boat's electrical system. The engine's charging system charges batteries connected to the charging system when the engines are running.

Battery isolators prevent accessory loads and other batteries from depleting power from charged batteries. Isolators also allow the engine's charging system to isolate the alternator charging output and distribute the charge among all batteries according to individual need.

The main DC control panel may feature a voltmeter, battery test switch, fuses, circuit breakers and a master breaker switch.

⚠ WARNING *Fire Hazard: Never reset a breaker that has been automatically tripped or replace a fuse that has blown without first identifying and correcting the cause of the problem. A fire could result.*

⚠ WARNING *Fire Hazard: DO NOT exceed the recommended fuse sizes or bypass the fuse safeguard. Always install the proper (type and rating) fuses whenever replacing or changing fuses.*



PROPELLERS

The following basic information may not apply to all engines. See the *Engine Operator's Manual* for information on propellers for the boat. Consult the boat dealer for assistance when replacing or servicing propellers.

The propeller converts the engine's power into the thrust needed to propel the boat. Care and selection of the propeller is very important for proper boat operation. Propeller size is usually identified by two numbers, such as 13 x 19, and a material identification, such as aluminum or stainless steel. In the number sequence, the first number is the diameter of the propeller in inches and the second is the pitch in inches.

Pitch is the angle of the blades expressed in the theoretical distance a propeller travels in each revolution. In the previous example, the pitch is 19, which means that each revolution of the propeller pushes the boat 19 inches (483 mm) through the water.

Propellers on boats powered by outboard or sterndrive propulsion systems are usually replaced out of the water to prevent loss of parts and to ensure correct installation. Although propeller replacement can be completed with the boat in the water, it is not recommended. Remove an inboard-powered boat from the water for propeller replacement because the propeller is not accessible while the boat is in the water. Special tools are required for most applications. Always consult the boat dealer for assistance when replacing or servicing propellers.

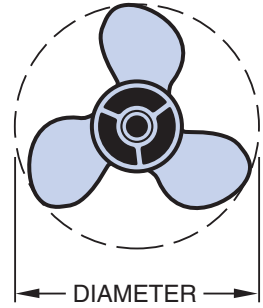

KC-0149-A

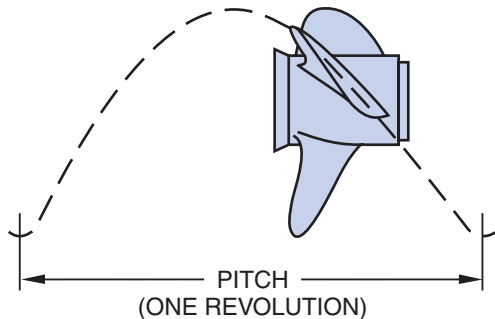

KC-0150-A



PROPELLER SELECTION AND REPLACEMENT GUIDELINES

There are many different propeller designs for specific operating characteristics. Always consult a certified marine technician when replacing your propeller.

To prevent accidental start-up, complete the following before installing or removing the propeller:

- Position the shift control in NEUTRAL.
- Position the battery switch to the OFF position and remove the key.
- Place a wood block between the cavitation plate and the propeller to hold the propeller in place. Remove the propeller nut.



WARNING

Personal Injury Hazard: Never use your hand to hold the propeller when removing the propeller nut; the propeller blades are sharp. Wear protective gloves.

DUAL-PROP DRIVES

Many stern-drive and some outboard-powered boats may use a dual-prop drive. Dual-prop drives have one prop turning clockwise and the other prop turning counterclockwise. Dual-prop drives come in rear-facing (stern-drive/outboard) and forward-facing (pod) designs. With either design the forward prop (referenced to the bow of the boat) turns counterclockwise while the rear prop turns clockwise.

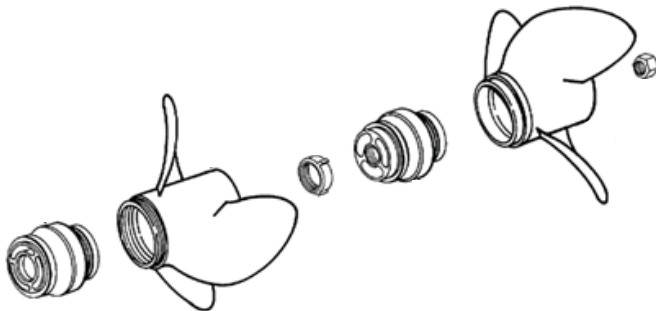

KCB-0012

In dual-prop drives, either prop can have three or four blades and have different pitches and/or diameters. Some configurations can increase top speed at the expense of fuel economy. Always treat the propellers on dual-prop drives as a set and change them out as a set even if only one is damaged. Read the drive manufacturer's owner's information carefully and consult the dealer or a marine propeller specialist for assistance.



GAUGES / INSTRUMENTS

The following basic and typical information may not apply to your specific boat. This section may not cover all gauges on the boat. See the *Engine Operator's Manual* or equipment manufacturer's supplied information on the use and operation of the unique gauges and instruments.

Gauges are visual indicators that help you monitor various system and component operation parameters. Gauges usually have lights integrated into them for visual clarity when operating at night. They are located near the helm area or other main control areas.

MULTI-GAUGES

The boat may be equipped with one or more multi-gauges that combine an analog look with digital display of specific data such as fuel management/economy, trip logs and GPS and is speed-selectable with the touch of a button. Some multi-gauges allow boaters to customize the type of information and how it is displayed. These gauges communicate digitally over an NMEA 2K or CANBUS network and replace mechanical gauges, sensors and wires. Most units support multiple propulsion units and share data with other operation stations. Refer to the *Gauge and Propulsion Manufacturer's Owner's Manual* for more information.

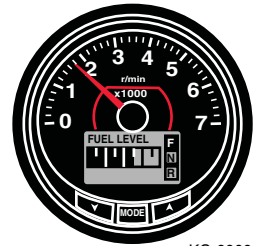

KC-6000

TACHOMETER

The tachometer indicates engine speed in revolutions per minute (rpm). Monitor engine rpm at all times to keep the engine within the proper rpm operating range. See the *Engine Operator's Manual* for the rpm operating range of your engine.

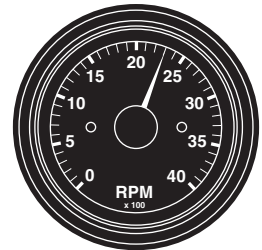

KC-0095-A



SPEEDOMETER

The speedometer indicates approximate forward boat speed in miles per hour (mph).



KC-0098-A

FUEL LEVEL GAUGE

The fuel level gauge indicates approximate fuel level in the fuel tank. The accuracy of the fuel gauge may vary as the attitude of the boat changes; the reading is only an approximation. As a general rule, always use the “one third” rule. Use one third of the fuel to reach your destination, one third to return and one third as reserve fuel.

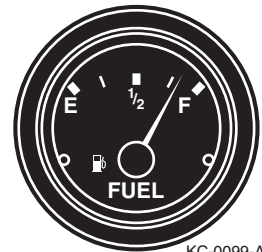

KC-0099-A

ENGINE WATER PRESSURE GAUGE

The engine water pressure gauge indicates the water pressure of the engine cooling system in pounds per square inch (psi). This gauge monitors the engine cooling system operation and indicates overheating problems. See the *Engine Operator's Manual* for the normal operating range.



KC-0100-A



POWER TRIM / TILT GAUGE

The power trim/tilt gauge indicates the angular position of the lower drive unit and propeller in relation to the transom of the boat.



KC-0101-A

VOLTMETER

The voltmeter indicates the voltage of the main cranking battery in volts DC. See the *Engine Operator's Manual* for the normal operating range.

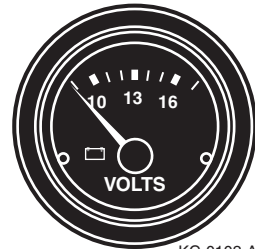

KC-0102-A

ENGINE WATER TEMPERATURE GAUGE

The engine water temperature gauge indicates the water/coolant temperature of the engine cooling system. Most marine engines use seawater to cool the engine. A sudden increase in temperature could be an indication of a blocked cooling passage or a water pump malfunction.

Check the gauge immediately after starting the engine. If the temperature gauge is high, STOP the engine immediately and see the *Engine Operator's Manual* for corrective action.

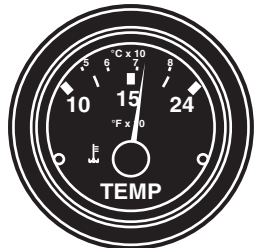

KC-0104-A



ENGINE HOUR METER

The engine hour meter indicates the total number of hours the ignition switch is in the ON position. Under normal conditions, the engine is running when the ignition switch is ON; therefore, the hour meter provides an approximate indication of engine hours. An hour meter is useful in determining scheduled maintenance.

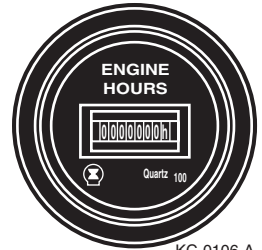

KC-0106-A

OIL LEVEL GAUGE (OUTBOARD ENGINE OIL INJECTION OPTIONAL)

The oil level gauge indicates the level of outboard engine oil in the reservoir used for the oil injection system. Some oil injection systems may provide an indicator on the reservoir. See the *Engine Operator's Manual* for additional information.

WATER DEPTH GAUGE

The water depth gauge indicates the approximate distance between the bottom of the boat and the earth's surface directly below the transducer. To avoid running aground in shallow water, always add extra distance to meter readings. See the manufacturer's instructions for installation requirements and operating instructions.

COMPASS

A compass assists in navigation by indicating where approximate north is located. See the manufacturer's instructions for operating instructions.

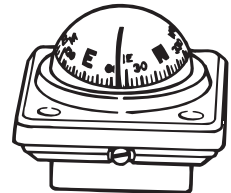

KC-0107-A

ENGINE WARNING ALARM SYSTEM

The engine may have integrated audible alarms to warn of engine overheating, low oil pressure or other conditions. See the *Engine Operator's Manual* for more information.



HELM AND CONTROL SWITCHES

The following information is intended as basic and typical and may not apply to your specific application. Not all switches may be covered in this section. See the *Manufacturer's Operator's Manual* for specific information on the use and operation of switches in the boat.

Many of the electrical features and systems in the boat are equipped with a control switch and protected with breakers or fuses. Switches are designed for different applications and found in many styles and shapes. Some switches may have a lighted indicator for easy ON/OFF identification. Some switch panels contain a master power switch that controls power to all circuits.

IGNITION SWITCH

The ignition switch controls the engine starter circuit, the engine ignition system and accessory circuits connected to the ignition switch.

BATTERY SWITCH

Battery switches are used to control battery power distribution and disconnect the batteries from the boat's electrical system. Battery switches are designed in many styles and for different applications. They generally provide battery isolation when used with multiple batteries and are used primarily as a method of quick and positive battery disconnection. Battery switches also protect against tampering, electrical fire hazards and battery drain. Keep this switch off when not using the boat or when storing it for extended periods of time.

NOTICE

Do not turn off the battery switch with the engine running; this could damage the engine's charging system.

Consult a qualified, knowledgeable technician for proper operation of the boat's specific electrical system.

ONE BATTERY

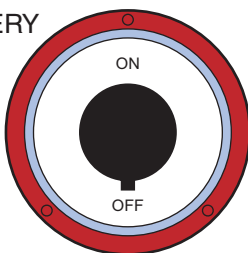

TWO BATTERIES

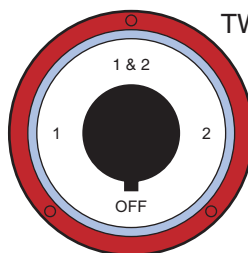

TYPICAL BATTERY SWITCHES

KCB-0006



ENGINE EMERGENCY STOP SWITCH AND LANYARD

The engine emergency stop switch controls the engine ignition ON/OFF. This safety device shuts the engine off immediately and prevents the boat from becoming a runaway if the operator is accidentally thrown from the seat or away from the helm.

Whenever the boat's engine is on, physically secure one end of the emergency engine stop switch lanyard to the emergency stop switch and the other to the boat operator. If the operator is thrown from the seat or moves too far from the helm, the lanyard will disconnect from the switch, activating the switch to turn off the engine.

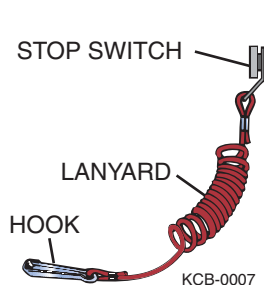

WARNING

Control Hazard: Never remove or modify the engine emergency stop switch and/or lanyard.

- **Always check the switch for proper operation. With the engine running, pull the lanyard. If the engine does not stop, have the switch repaired before continuing to operate the boat. Never operate the boat if the engine emergency stop switch does not work.**
- **Attach the engine stop switch cord lanyard to a secure place on your clothing, your arm or leg while operating.**
- **Avoid accidentally pulling the cord lanyard during normal operation. Loss of engine power means loss of most steering control. Also, without engine power, the boat could slow rapidly. This could cause people and objects in the boat to be thrown forward.**
- **DO NOT attach the cord lanyard to clothing that could tear loose. DO NOT route the cord lanyard where it could become entangled, preventing it from functioning.**

NEUTRAL START SAFETY SWITCH (START-IN-GEAR PREVENTION)

The neutral start safety switch provides start-in-gear prevention. The switch controls power to the engine starter circuit of the ignition switch. The engine gear shift control lever must be in the NEUTRAL position to allow the ignition switch to activate the engine starter. This safety device will prevent the boat's engine from starting if the engine is in gear.



HORN SWITCH

The horn switch controls power ON/OFF to sound the horn.

BOARDING AND COURTESY LIGHT SWITCHES

The boarding and courtesy switches control power ON/OFF to boarding lights and cockpit courtesy lights.

POWER TRIM / TILT SWITCH

The power trim/tilt switch controls power ON/OFF to the engine's power trim/tilt electric hydraulic pump. This switch is usually a three-position switch, with OFF in the center. If engine is equipped with power trim and tilt, this system allows you to raise and lower the lower drive unit and propeller to adjust trim (the planing, and running angle of the boat while underway).

The tilt feature positions the lower drive unit up beyond the power trim range and is used for trailering, launching or beaching. Never use power tilt when the engine is running.

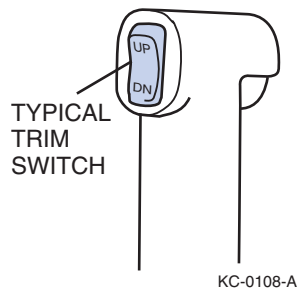

NAVIGATION LIGHTS SWITCH

The navigation lights switch controls power ON/OFF to the boat's navigation, running and anchor lights. This switch is usually a three-position switch, with OFF in the center. When the switch is in the NAV position, the red and green navigational, white stern and running lights, and console gauge lights are activated. When the switch is in the ANC position, only the white stern light is activated.

Never operate the boat between sunset and sunrise using only the stern light. Use all navigational lights when operating underway between sunset and sunrise.

BILGE PUMP SWITCH

The bilge pump switch controls power ON/OFF to the bilge pump to remove excess water from the bilge area of the boat. Some models are equipped with an automatic bilge pump setting. Switching to AUTO when the boat is in operation will allow water to be automatically pumped out when it reaches a level that activates the float switch in the bilge area.

**NOTICE**

Be sure to switch the bilge to OFF (not AUTO) when your boat is not in use. Wave action or trailer travel can cause the pump to drain the battery. Running the pump when the bilge is dry will damage the pump. Do not allow the bilge pump to operate after all the water has been cleared from the bilge area; damage to the pump will occur if the pump is allowed to operate without water.

If oil is spilled in the bilge, do not run the pump. Keep the oil from spreading in the bilge and properly dispose of the oil on shore.

BILGE PUMP SYSTEM

The Federal Water Pollution Control Act prohibits the discharge of oil or oily waste into the water. Violators can be fined \$5,000.

Water will enter a boat for a number of reasons, including heavy seas, strong storms and long periods of rain. The bilge area is usually the deepest part of the hull and where the water settles. The bilge pump moves water from the bilge area through hoses and empties it through an opening in the hull.

The bilge pump can be operated manually by a switch. Some models feature an automatic bilge pump setting. Switching to AUTO when operating the boat will allow water to be automatically pumped out when it reaches a level that activates the float switch in the bilge area.

NOTICE

Be sure to switch the bilge to OFF (not AUTO) when you are not using the boat. Wave action or trailer travel can cause the pump to drain the battery. DO NOT allow the bilge pump to operate after all the water has been cleared from the bilge area; damage to the pump will occur if you operate it without water.

BOAT VENTILATION SYSTEM

Boat ventilation systems allow the circulation of fresh air through compartments and enclosed areas of boats. The most common types of ventilation devices are manual or power-actuated vents, hatches, ports and windows that open and close. Ventilation ports are always located in head and galley compartments and are commonly found in cabins and sleeping areas.



RAW WATER SYSTEM

Raw water is seawater (non-drinking water). Some boats use raw water systems for engine cooling, head, and utility and cockpit washdowns. Some raw water systems may supply two components and have a flow control valve for directing water flow.

Raw water systems include:

- An individual thru-hull raw water intake.
- A seacock and strainer. The seacock protects your boat from sinking if a downstream hose or fitting would fail. Always close any seacock not in use.
- A pump to draw water into the system. Engines may have belt- or pulley-driven pumps; heads may have manual push/pull or electric pumps, and utility and cockpit washdowns may have electric pumps.
- An outlet valve, fitting or nozzle.

Guidelines when operating a raw water system:

- Open the desired seacock.
- Adjust flow control valve (if equipped).
- Turn on appropriate pump switch as required.

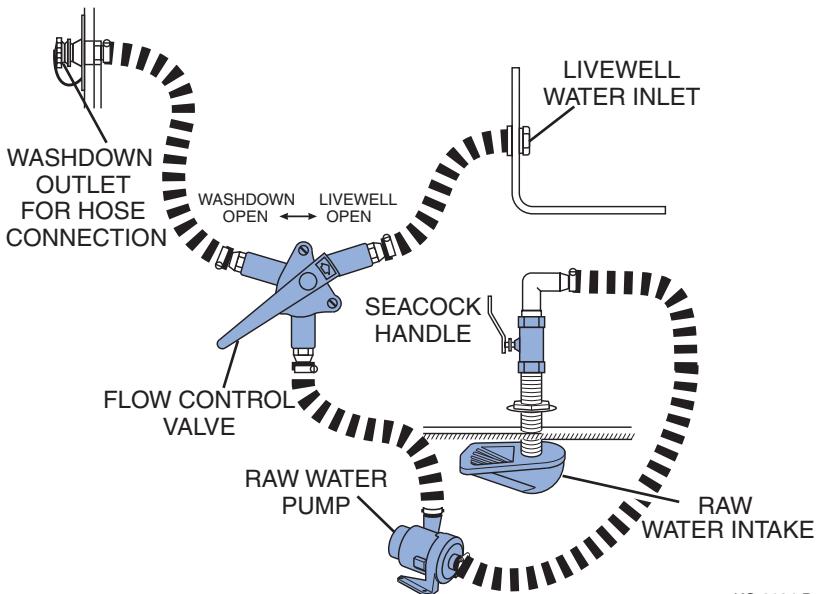

KC-0184-B



LIVEWELLS

Livewells are designed to help protect and keep fish or bait alive. Some are equipped with an aeration pump that circulates and refills the water in the livewell to help keep fish alive.

Always clean and empty the livewells after each use to prevent contaminating the fish. Never use soap, detergents or other cleaners that may be harmful to fish to clean the livewell.

If a livewell system does not drain completely, you may have to bail remaining water by hand or remove your boat from the water.

NOTICE

To avoid freeze damage to the livewell system, be sure it is completely empty in freezing weather. Residual water in the system may freeze and cause damage.

Livewell systems are usually manual, remote or recirculating. Do not use manual and remote livewell systems while your boat is in operation or on the trailer. Also, make sure the livewell pump is switched off, or pump damage will occur.



MANUAL LIVEWELL

Manual livewells aerate the water by continuously pumping sea/lake water into the well. A spray-head nozzle aerates the water by spraying water into many small streams that splash into the livewell water.

To fill the livewell, install the removable overflow tube (or drain plug if equipped with an overflow fitting) into the drain hole, and turn on the livewell pump. The water level will maintain the height of the overflow.

To empty the livewell, turn off the livewell pump and remove the overflow tube (or drain plug).

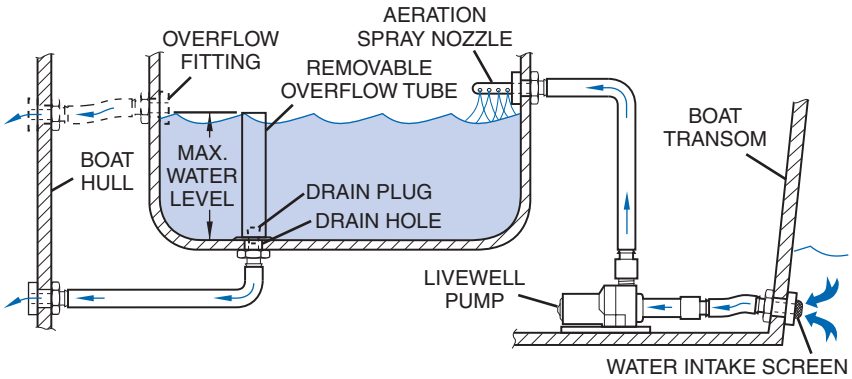

TYPICAL MANUAL LIVEWELL SYSTEM

KC-0181-A



RECIRCULATING LIVEWELL

Recirculating livewells allow water recirculation while a boat is in operation or on the trailer. Like manual and remote types, this system continuously aerates the livewell with sea/lake water while you are fishing. While underway or when trailering, the system can be closed to recirculate the water in the livewell. During recirculation, keep in mind that sea/lake water is not used and water temperature increases quickly, which may kill the fish in the livewell.

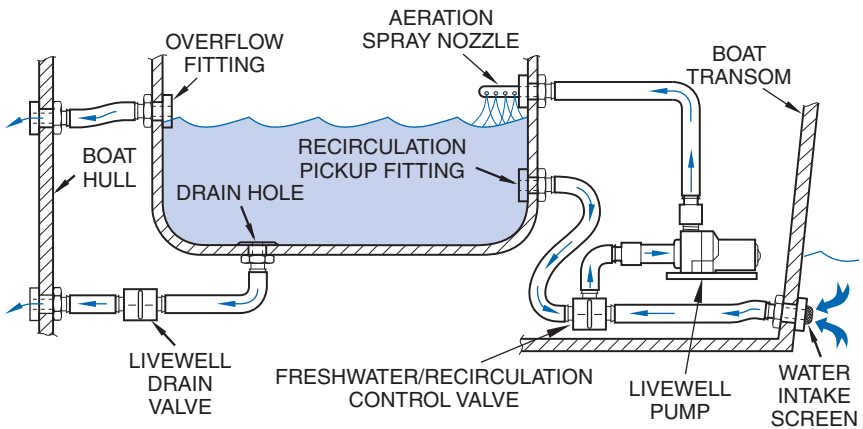

TYPICAL RECIRCULATING LIVEWELL SYSTEM

KC-0183-A



REMOTE LIVEWELL

Remote livewells operate similarly to manual livewells; the primary difference is the addition of a remote-controlled livewell drain. The drain valve control is usually located near the helm or the livewell.

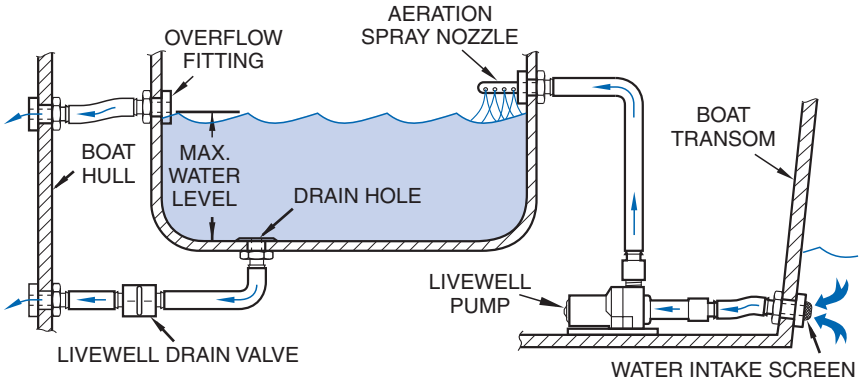

TYPICAL REMOTE LIVEWELL SYSTEM

KC-0182-A

LIVEWELL CONTROLS AND OPERATION

Livewell Pump Switch

The livewell pump switch controls the livewell pump ON/OFF. Some models may have an automatic setting for use in conjunction with the livewell timer to vary the ON/OFF time cycle. On models with an automatic setting and no timer, the time cycle is approximately one minute on and three minutes off.

NOTICE

Most livewell systems draw power from the main engine cranking battery. The automatic setting, if available, will help conserve battery power.

Livewell Timer

A livewell timer can continuously vary the OFF time interval. Pump ON interval will remain at approximately one minute regardless of the OFF time setting. On models with two livewells, this timer may be wired to control both livewell pumps.



Livewell Control Valve

The livewell control valve controls the ability to select between sea/lake water and recirculation operation. This valve must be in the recirculation (closed) mode whenever the boat is in operation or on a trailer. If the valve is left open, water can siphon out of the livewell and kill the fish.

Livewell Drain Switch

The livewell drain switch turns the livewell drain pump (if equipped) on/off. Be sure to turn the pump off when it is not in use.

ELECTRIC TROLLING MOTOR SYSTEMS

See the *Electric Trolling Motor Operator's Manual*.

Electric trolling motors are generally used by anglers to quietly and slowly maneuver their boats while fishing. Trolling motors are available in many types and sizes and usually mount on the bow of the boat.

TROLLING MOTOR BATTERIES

Electric trolling motors depend on batteries for power. Deep-cycle batteries are recommended for use with trolling motors, as they can provide the longest use/charge time and are designed to be charged and discharged repeatedly. Use battery switches to disconnect the trolling motor from the batteries when not in use.

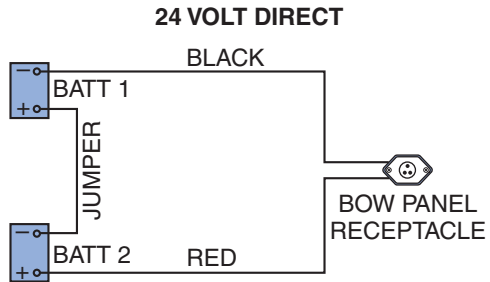

KC-0152-A

Battery usage and setups vary depending on the application and manufacturer recommendations. Trolling motor battery setups are 12-volt, 12/24-volt or 24-volt, and may include a battery isolator and on-board charging system.



WARNING

Fire/Explosion Hazard: Hydrogen gases produced by a lead acid battery while it is charging, or the engine is running, can cause a fire and/or an explosion.

The diagram illustrates some typical trolling motor battery installations.



TROLLING MOTOR CONTROL PANEL

Bow-mounted trolling motors sometimes use control panels in the bow area to provide terminal connections for the trolling motor and battery. These motors may also include connections for an external battery charger, control switches, indicators and battery gauges.

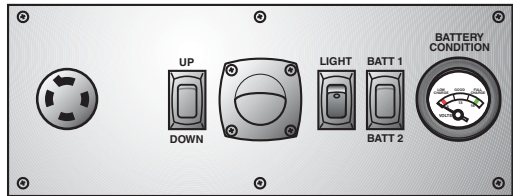

TYPICAL BOW PANEL

KC-0180C-A

Trolling motor battery gauges indicate energy remaining in the deep-cycle batteries. To show the charge level, typical gauges have either a series of light-emitting diodes (LEDs) or an indicator needle. Where applicable, a battery gauge switch may be used to select each battery in the system to check the individual condition of each battery.

FISH LOCATORS, GRAPHS AND DEPTH INDICATORS

Fish finders and graphs are available in many different types for various applications. Typical finders use a transducer mounted below the waterline on the hull of the boat. The transducer sends and receives electrical signals through the water that are interpreted by the finder to calculate depth and any structure beneath the boat. A display on the finder generates a representative image showing depth, structure and fish. See the manufacturer's information for operating instructions.

FISHING SEATS

See the seat manufacturer's information for operation and maintenance instructions.

Typical fishing boats may use pedestal-mounted seats that allow anglers to sit higher in the boat. Pedestal seats provide better maneuverability and visual perspective while fishing.



WARNING

Man Overboard Hazard: DO NOT sit in pedestal seats on high platform locations while underway except at trolling speeds. You risk being thrown overboard.

Pedestal seats in the bow area can restrict the driver's view and must be removed when underway at speeds other than trolling.

Section 10

GENERAL CARE AND MAINTENANCE

The boat may feature a variety of specialized systems and components. The following basic and typical information may not apply to your specific application. This section may not cover all systems or components on the boat. See the *Engine Operator's Manual* or the equipment manufacturer's information for maintenance procedures.

Maintenance procedures may require special knowledge and equipment. Always consult the boat dealer for assistance in performing service, maintenance or modifications to the boat.

Neglect of maintenance and unauthorized service work is not recommended and may void your warranty. Refer to the *Engine and Equipment Manufacturer's* maintenance schedules and requirements, and keep a detailed log of the procedures and dates completed. Always consult the boat dealer for assistance with periodic maintenance.

Before performing any general care and maintenance procedures within this section, review *Safety in Section 2*.

ENGINE

The manufacturer of the boat's engine(s) will provide a separate maintenance procedure. See the *Engine Operator's Manual* for specific information on maintenance procedures.

FUEL SYSTEM

 WARNING *Fire/Explosion Hazard: Gasoline is extremely flammable and highly explosive under certain conditions.*

Be sure to check the fuel hoses and connectors for leaking and deterioration before fueling and on a monthly basis.

Fuel vents are normally located in the deck in the same general area as the fuel fills. Periodically check that the fuel fills and vent lines are free of obstructions and kinks.

Check and/or replace the fuel filter periodically or clean as needed. Check fuel lines, vent hoses and drain hoses frequently for leaks. Replace any worn or cracked hoses.



Tightening a fitting or clamp may correct a fuel leak. If the leak continues, however, replace the line, fitting or hose immediately to prevent a build-up of fluids or gases.

Use fuel system parts certified for marine use only. Never use automotive parts in marine applications.

ELECTRICAL SYSTEM

Before performing any work on the electrical system or the battery, review *Safety in Section 2*.

BATTERIES

⚠ WARNING *Electrical Shock Hazard: Always disconnect the batteries before performing maintenance on the DC electrical system. Electrical shock may occur if the batteries are not disconnected during maintenance on the DC electrical system.*

⚠ WARNING *Personal Injury Hazard: Always wear gloves and protective eyewear when working on and around the batteries. The batteries contain an acid called electrolyte. Avoid causing damage that could spill electrolyte into the bilge when servicing the batteries. Avoid getting salt water in or on the battery. Either condition can create a poisonous gas that is harmful if inhaled. Always disconnect the batteries before cleaning.*

⚠ CAUTION *Personal Injury Hazard: Never allow a tool to bridge across the battery terminals. Injury can result if the terminals are accidentally bridged with a tool or other conductor.*

Today's boats can be loaded with electronics that all run off the boat's battery. Because of this, many boats will have two or more batteries: one for starting and running the engine, and one for electronics, commonly referred to as the house battery. One advantage is that the starting battery will not be drawn down when using electronics with the engine off, such as with a stereo. Another advantage is if the starting battery has lost capacity because of age, the battery switch has a 1+2 (Both) position that parallels both batteries for emergency starting. See the Blower Switch section of this manual for more information.

Marine batteries generally come in two types: starting and deep-cycle. Starting batteries are similar to car batteries, can supply lots of current for a short period of time and are used for starting the engine. Starting batteries should be recharged almost immediately and do not tolerate deep discharges. Deep-cycle batteries are designed for repeated discharging and recharging cycles without damage. They are used as the house battery on boats with higher DC power requirements.



All batteries have one thing in common — they run for a while, need recharging and require an eventual replacement as the capacity fades. Most marine batteries are sealed and require no maintenance other than keeping them at a full state of charge and diligently cleaning corrosion from the terminals. To maintain long life, deep-cycle batteries should not be discharged more than 50% before they are recharged.

Most marine batteries are flooded, sealed lead-acid, but there are several different battery types/chemistries that could be used. You must use caution when charging or replacing the batteries; replace batteries with the exact same type, group and capacity. If your boat is not equipped with an onboard battery charger, use a smart charger suitable to your battery type/chemistry.

**CAUTION**

Burst Hazard: Never use an automotive type (lead-acid) battery charger to charge a gel cell type battery. Doing so will cause damage to both the charger and battery and can cause the battery to burst. Use a battery charger specifically designed to charge gel cell type batteries.

Always turn off the battery switch (if equipped) or disconnect the negative battery cable before servicing the electrical system.

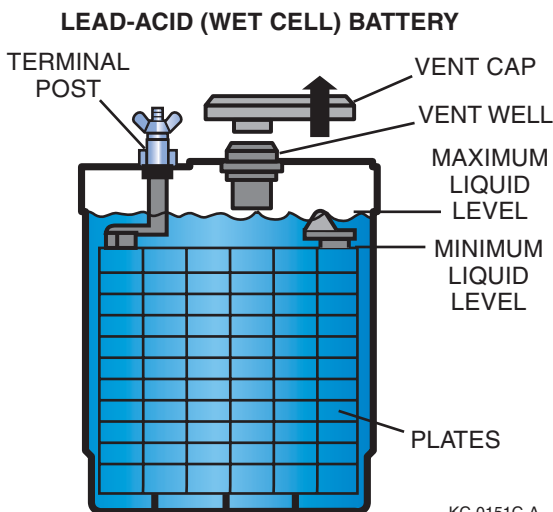



SECTION
10 GENERAL CARE AND MAINTENANCE

When you install a battery:

- Make sure the battery terminals are clean.
- Be certain to use correct polarity when you connect the battery cables to the battery.
- Make sure the cable connections are tight.
- Always shut down the engine before removing or attaching battery cables and never run the engine with the battery cables disconnected.
- Always remove the negative (-) cable first. Always attach the negative (-) cable last.

Check the battery frequently for signs of corrosion. If corrosion is evident, clean the terminal posts with a baking soda and water solution and a wire brush. Disconnect the battery terminals before cleaning.

 **WARNING** *Burn Hazard: Lead-acid battery fluid can cause severe burns.*

Check the fluid levels in the cells.

NOTICE *Some batteries are sealed and cannot be filled. A level of approximately 1/4 to 1/2 in. (6 to 13 mm) above the plates is sufficient. If needed, fill with distilled water; do not overfill.*

During extended periods of non-use, batteries will self-discharge and should be recharged. Before recharging, disconnect the battery terminals and remove the battery from the boat. Recharge the battery according to the directions enclosed with the battery and battery charger. When installing the battery in the boat, make sure the battery is secured in the battery box, the terminals are tight and all protective covers are in place.

 **WARNING** *Fire/Explosion Hazard: Hydrogen gases produced by a lead-acid battery while it is charging, or the engine is running, can cause a fire and/or an explosion.*

CIRCUIT BREAKERS AND FUSES

Never exceed the recommended fuse sizes or bypass a fuse in a circuit. Always install the proper (type and rating) fuses whenever replacing or changing fuses. Continuous fuse/breaker failures indicate a severe problem and require immediate attention.



⚠ WARNING *Fire Hazard: Never reset a circuit breaker that has been automatically tripped or replace a fuse that has blown without first identifying and correcting the cause of the problem. Failure to correct the cause may result in a fire hazard.*

TYPICAL BREAKER / FUSE PANEL



KC-0247C-A

Some applications use circuit breaker switches to provide individual circuit protection with the ability to manually reset the breaker switch.

To reset a tripped circuit breaker, move the breaker switch to OFF. Identify and correct any problems with the circuit and unplug all loads connected to it. Wait a minimum of one minute for the breaker switch to cool and then push the breaker switch to ON. Turn the breaker switch to OFF immediately if it trips, and consult qualified personnel.

To replace a fuse, locate the fuse block and the failed fuse. Carefully remove the fuse without touching other fuses or wires. When possible, use a fuse removal/installation tool. Some accessories have in-line fuses accessible inside the helm or near the battery.

⚠ WARNING *Fire Hazard: DO NOT exceed the recommended fuse sizes or bypass the fuse safeguard. Always install the proper (type and rating) fuses whenever replacing or changing fuses.*

**NOTICE**

A boat's electrical system is designed to protect you from electrocution, short circuits and overloads. Have a qualified electrician perform any modifications to the system such as adding electrical accessories. Some installed accessories, such as stereos, have an additional fuse located in-line with the positive lead. Other accessories may use in-line fuses near the battery.

GALVANIC CORROSION

Galvanic corrosion (electrolysis) is the deterioration of metals from the effects of electrolytic action. When two dissimilar metals are immersed in a conductive fluid such as salt water, an electric current is produced, much like a battery. As current flows between the two metals, the softer, or sacrificial, metal deteriorates.

If you operate in salt, polluted or brackish waters, the boat should be equipped with a transom-mounted sacrificial anode to prevent corrosion damage to other metal parts of your boat that are in contact with the water. The anodes are self-sacrificing and are slowly eroded by electrolytic action. These anodes are important and require periodic inspection for deterioration. Replace the anode when it is less than 50% of its original size.

Most engines are equipped with one or more anodes that require periodic inspection. See the *Engine Operator's Manual* for maintenance procedures.

Electronic cathode systems are designed to reduce the effects of electrolysis. Electronic cathode systems emit an electrical low-current charge into the water near the metal components' neutralizing electrolytic action.

NOTICE

Do not paint or coat sacrificial anodes or cathodes with any substance. Once covered, they do not provide protection from galvanic corrosion. Replace anodes if they have deteriorated 50% or more.

SALTWATER CORROSION

Rinse the boat hull and deck with fresh water and wash immediately after using the boat in salt water. If the boat is used primarily in salt water, wax the hull monthly and apply corrosion inhibitor to all hardware. See the *Engine Operator's Manual* for the flushing procedure.

Flushing the freshwater engine cooling system is recommended when the engine has been used in salt, polluted or brackish waters. Flush the entire engine cooling system with fresh water for at least 5 minutes after use in these waters. Consult the boat dealer for suitable flushing equipment.



SACRIFICIAL ANODES

Anodes (sometimes called “zincs”) are used to protect hardware exposed to the water. Since galvanic corrosion attacks the least “noble” metals first, less noble metal anodes are used to purposefully “sacrifice” themselves, thereby protecting the more noble metals of the drives, propeller, tabs, boarding platform and other metal items below the waterline (such as underwater gear).

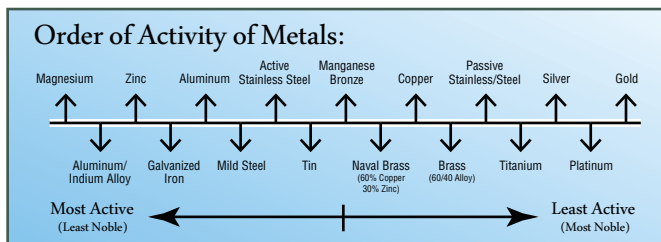

KC-6009

Anodes may be installed on the boat transom and/or bottom at the factory. Additional anodes may be installed on the underwater gear as well as any metal components exposed to raw water, such as heat exchangers and water cooling jackets. Anodes are made in three different metals which must be matched to the water type and local conditions. Most boats are equipped from the factory with zinc anodes on the recommendation from engine and drive manufacturers. The anodes that are installed on the trim tabs are typically zinc and are isolated from the boat bonding system.

Selection, monitoring and replacement of the anodes on the transom, drives, trim tabs, boarding platform supports and other underwater gear is the customer’s maintenance responsibility. Any damage done because of lack of maintenance will not be covered under warranty.

WATER TYPE	ANODE MATERIAL	REPLACE AT
Salt water	Zinc	40% decomposition
Brackish water	Aluminum	50% decomposition
Fresh water (clean)	Aluminum/magnesium alloy	50% decomposition
Fresh water (polluted)	Magnesium	40% decomposition

**NOTICE**

To be effective, anodes must be bare metal. If the boat is dry-docked more than 24 hours, sand the anodes to clean oxidation from the surface.

- Zinc and aluminum anodes left in fresh water or zinc anodes used in brackish water will become covered with white oxide which effectively stops the sacrificial process and exposes the underwater gear to damage.
- Do not paint sacrificial anodes. Bottom paints/sealants on anodes will block the sacrificial process and expose the underwater gear to damage.
- Depending on local conditions, some anodes can deteriorate very quickly and must be closely monitored. See the boat dealer for recommendations.

Because of the vital function that anodes play in the protection of underwater gear, replace anodes at the recommended level of decomposition, or annually, with the correct type. Boats stored in salt water will normally need to have the anodes replaced every 6 months to one year. Anodes requiring replacement more frequently may indicate a stray current problem within the boat or at the slip or marina.

Anodes that do not need to be replaced after one year may not be providing the proper protection. Loose or low-quality anodes could be the problem. There could also be a problem in the bonding system or the wrong anode material is being used.

The boater/customer has the responsibility in maintaining and ensuring that the proper anodes are installed for the area (water) in which the boat will be used. See the boat dealer about changing material or adding additional anodes.

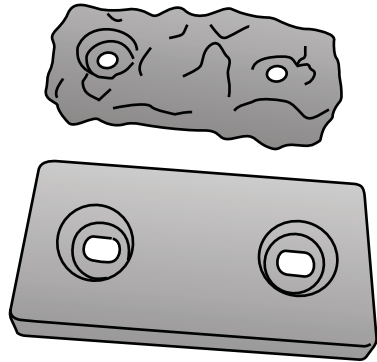

KC-6006

STEERING SYSTEM

Inspect and maintain the boat's steering system regularly. Frequently check the hardware at the helm, engine or rudder end for tightness. See the *Engine Operator's Manual* or the steering manufacturer's information for the appropriate torques.



TYPICAL HYDRAULIC STEERING SYSTEM

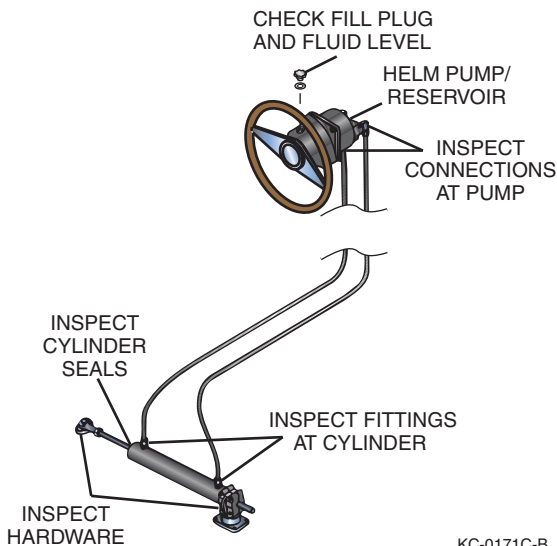

Make sure hydraulic hoses are tight and leak-free. Check cylinder seals for dampness, which indicates leaking. Check the fluid reservoir monthly and top off if necessary. See the steering system manufacturer's information for more details.

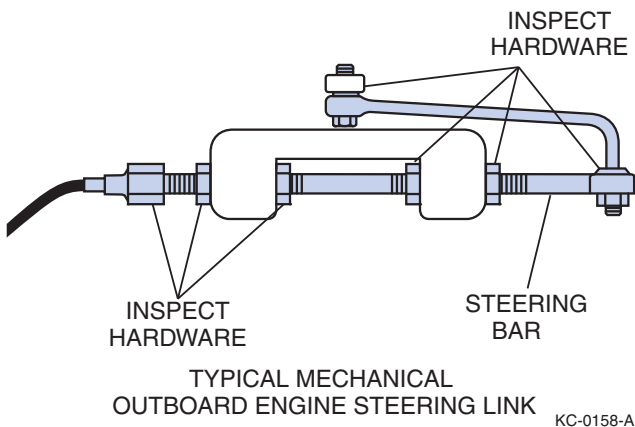

CORROSION PROTECTION

HARDWARE, FASTENERS AND FITTINGS

Check all fasteners, fittings, hinges, latches, rails and cleats for corrosion and tightness. Repair or replace any items that need attention. Never use automotive replacement parts when replacing marine parts.

Periodically clean all hardware with approved marine cleaners or mild soap and water. Never use abrasive cleaners or materials; they will scratch the polish and protective coatings on the hardware and cause the hardware to corrode. Applying a coating of marine-grade wax can help maintain the original shine of the hardware and help prevent corrosion.

STAINLESS STEEL AND CHROME HARDWARE

Stainless steel and chrome will normally oxidize over time, especially in marine environments. Cleaning and preventive maintenance of stainless steel and chrome hardware are crucial in maintaining appearance and functionality. If the hardware is left unattended, it can corrode, causing the hardware to appear unsightly and cause structural integrity problems.

Wash the stainless steel and chrome hardware with mild soap and water after operating the boat in corrosive environments such as salt water.

Remove rust or corrosion promptly by cleaning the hardware using a high-quality stainless steel, chrome cleaner or conditioner. Do not use any abrasive materials such as steel wool or sandpaper to clean the hardware. Do not use acids or bleach or any cleaners not intended for stainless steel or chrome, such as glass, tile or counter cleaners, as these types of cleaners can cause permanent damage. Always test a cleaner in an inconspicuous area first before applying to the complete surface.

After cleaning, protect the surface of the hardware by using a high-quality boat, automotive, stainless steel or chrome protectant or wax.

ALUMINUM HARDWARE

Periodically wash aluminum hardware with soap and water to keep it clean. If the boat is used in salt water or polluted water, wash aluminum hardware with soap and water after each use. Salt water allowed to remain on aluminum will penetrate the metal and corrode the aluminum.



It is recommended to frequently clean and coat all aluminum hardware with a metal protectant made for aluminum to protect against pitting and corrosion caused by the harsh effects of salt water. Choose an appropriate cleaner specific to your needs, as special cleaners are available for different types of aluminum hardware such as anodized, powder coated and polished.

Most stains can be removed from aluminum with a metal polish or fine polishing compound. To minimize corrosion, use a caulking compound or Teflon-based sealer to isolate hardware and fasteners mounted to aluminum fabrications. With proper care, aluminum hardware can provide many years of service.

GENERAL MAINTENANCE AND CLEANING



WARNING

Asphyxiation Hazard: Do not mix cleaning agents together; toxic vapors may be released. Read and follow safety-related precautions found on the product labels.

MARINE GROWTH

If accelerated marine growth is a problem in your area, an antifouling bottom paint may be necessary to slow growth and prevent gelcoat damage. Before selecting a bottom paint, talk to the boat dealer to determine which product works best in your area. Many local variables can affect the selection of paint. Be sure to follow the paint manufacturer's directions exactly.

CLEANING

Never allow any type of cleaning solution or cleaning material to come in contact with the water or be discharged into the water. The discharge of any type of debris or waste, including, but not limited to, food, trash, garbage, oil, fuel, liquids and human waste, is highly restricted, if not unlawful, in most waterways. Never discharge anything into the water.

Periodic cleaning is the best way to keep the boat looking new. Regular washing and waxing keep dirt, algae and water deposits from building up and deteriorating the finish. Keeping the boat in "show room" condition means greater personal satisfaction and higher resale value. Special cleaning products are available from the boat dealer.



HULL

When washing the boat, use a mild detergent with a warm water solution. Never use any kind of alkaline cleaners such as Tri-Sodium Phosphate (TSP), abrasive cleaners, solvents, ammonia or chlorine to clean gelcoat surfaces, as these will damage the gelcoat surface. Special cleaners are available from the boat dealer to remove marine growth and algae from the hull.

Wax gelcoat surfaces at least twice a season. Special marine gelcoat waxes are available from the boat dealer to prevent color fade and dirt adhesion. If the gelcoat has oxidized, chalked, dulled or faded from lack of proper maintenance, buffing may be necessary to bring back the shiny appearance. Hand buffing with #7 rubbing compound or power buffing with glazing compound #1 will quickly restore the surface; however, always seek certified assistance before attempting to restore your boat's finish.

UPHOLSTERY

Regular washing with mild detergent and warm water or non-solvent type automotive vinyl cleaner is sufficient to keep the cushions, canopy top and other vinyl coverings in good condition. Keep the cushions from becoming soaked and dry off thoroughly after washing to prevent mildew accumulation after the boat is covered. Position the cushions up in the boat when covered to allow air circulation and spray with mildew repellent.

For tough stains on vinyl such as adhesive and rust, use a citrus cleaner followed by a mild detergent and warm water. For ink stains, apply denatured alcohol and wipe off. Note that some products such as suntan lotion, shoe polish and wet leaves may stain permanently.

Although not always convenient, minimizing the boat's contact with damaging ultraviolet (UV) rays and storing removable seats and canopies indoors when not in use will increase the longevity of vinyl upholstery.

NOTICE

Certain automotive, household and industrial cleaners can cause further damage and discoloration. Be cautious when using solvents and dry-cleaning fluids, or products that contain dyes such as waxes. Whenever cleaning stubborn stains, test the treatment in an unseen area first. Use the following stain treatments with discretion. Between steps, be sure to rinse thoroughly with plenty of clean water and allow to dry.



CANVAS COVERS AND BIMINI TOPS

In most cases, boat canvas receives more abuse than any other item on a boat. Canvas must be regularly maintained for long life and top performance. Moisture, dirt and chemicals from industrial fallout, heat, ultraviolet rays and salt water can all contribute to the deterioration of canvas. These elements can cause serious damage if left unchecked. The following guidelines will help you keep your canvas in good condition for years to come:

- Convertible tops are not designed for extended exposure to the elements as a protective cover at dockside or when the boat is in storage. Use a full, properly fitted, light-colored mooring cover for these purposes.
- If canvas gets wet during use, remove any side curtains and open the windshield to allow both sides and all seams to dry. The air circulation will allow all canvas to dry and prevent the growth of mildew. Never store wet or damp canvas.
- Occasionally set up all canvas and curtains, and hose down with fresh water to remove accumulated soot and dirt. Sweep or brush the underside of the canvas to prevent the accumulation of dirt and mildew.
- Wet canvas must be allowed to dry thoroughly before storage. Never allow canvas to dry loose since shrinkage can occur. Install and stretch all canvas fully on your boat when drying.
- Never allow the canvas to be exposed to direct sunlight for long periods of time.
- Use care when handling clear vinyl curtains and windows to prevent scratching. Never use cleaners on clear vinyl curtains and windows. Use clean water and a soft, clean cloth.
- Never fold canvas where creases can form in the material. Loosely roll canvas to prevent damage.
- Never store canvas in plastic bags. Store canvas in a dry, well-ventilated compartment.
- Outer canvas surfaces can be cleaned with a soft scrub brush and either automotive convertible top cleaners or household cleaners suitable for use on vinyl surfaces. The underside of the canvas may be periodically sprayed with a spray disinfectant to prevent mildew.
- Never store or dock the boat under trees. Tree sap is very corrosive to canvas and can also be harmful to gelcoat and vinyl interiors.
- Adjust canvas top bows to eliminate pockets in which rainwater can accumulate. The weight of accumulated water can collapse or damage the canvas top.
- Lubricate snaps and zippers regularly. Vaseline, silicone spray or paraffin are effective lubricants. Never force snaps and zippers that are stuck.
- Never trailer the boat with the convertible top in the mounted position. Dismantle, roll and securely store all canvas while trailering your boat to prevent wind damage.



SECTION
10 GENERAL CARE AND MAINTENANCE

CARPET

Occasional vacuuming and washing with mild detergent and warm water or household carpet cleaners will keep the carpet clean. Thoroughly wash the detergent out of the carpet with clean water. Let the carpet dry in the sun to prevent any mildew or odor caused by moisture.

To clean mildew off the carpet, first check the cleaner on a small area of carpet that is hidden to determine compatibility of cleaner and carpet. "FISH ATTRACTANTS," which are commonly sprayed on lures and some insect repellants, will cause deterioration of the carpet backing. Spray these formulas away from the boat carpet and clean any spills promptly. DO NOT use pressure sprayers to clean boat carpet.

WINDSHIELD

A clean windshield is important. If the boat is equipped with a glass windshield, applying a nonabrasive glass cleaner with a soft cloth will remove most dirt. Clean tinted Plexiglas or plastic windshields with a mild soap solution and damp cloth only. Harsh detergents, solvents, chemicals or dry cloths used on any glass or plastic windshield will scratch the surface.

WINDOW CHANNELS

Nylon pile is typically used in sliding window channels. Never use any products that contain bleaching solutions to clean window channels or seals. Use only a mild detergent and water solution for cleaning. If windows stick, spray the channels with silicone spray while working the window back and forth.

TEAK

Teak is an organic and porous wood that contains natural oils and silicates that make it ideal for marine applications.

Depending on the interior or exterior application of the teak used on the boat, different cleaning and refinishing procedures may be required. The following information is intended as a guide. Always consult the boat dealer before performing any cleaning or refinishing procedures.

Cleaning

Only use approved teak cleaners and follow the manufacturer's instructions and warnings carefully. The use of unapproved teak cleaners, such as general or all-purpose cleaners, rust removers or cleaners containing acid, will damage the teak and/or fasteners and the caulking used to secure the teak.



When cleaning areas that have caulking in the seams between teak boards, use special care to prevent damaging or removing the caulking. Do not use cleaners containing chlorine.

When cleaning, always scrub across the grain using a Scotch-Brite™ type scrubbing pad or plastic bristle brush. Scrubbing with the grain may cause damage by removing soft grains from the teak. On larger areas, rotary scrubbers can be used.

Refinishing

Lightly sand all teak surfaces periodically to smoothen the exposed surfaces. This exposes less wood grain area to the elements and helps prevent the exposed grains from trapping dirt.

When sanding teak, the grit of the sandpaper and sanding method used depend on the condition of the teak. Minor scratches may be repaired using sandpaper (400 to 1000 grit). Major scratches and refinishing may require a sanding machine and the use of lower grit sandpaper. When sanding, always hold the sandpaper or pad flat on the teak to avoid gouging the teak.

To repair chips, cracks, plugs or breaks, special epoxies are available specifically for use with teak. When replacing caulking, take care to keep the seams dry and clean. Always use caulking approved for teak use and follow the manufacturer's instructions and warnings carefully. Immediately repair damaged areas or areas that always appear wet, as water leaking between seams or under the decking can cause further damage.

Sealants and Oils

The use of sealants or surface finishes on exterior applications is generally not recommended and should only be applied after consulting with the boat dealer. Never use sealants containing kerosene or petroleum products.

As teak is a porous material that contains natural oils and silicates, the use of protective oils or sealants is not recommended for exterior and most interior applications. Applying oil to teak can cause personal safety hazards, permanent teak damage and increased maintenance, and can shorten the life of the teak. In addition, teak oils can be harmful to other materials such as caulk, vinyl, plastics, gelcoats, etc.

BILGE

A boat's bilge area accumulates oil and greasy dirt over a period of time and should be cleaned periodically. Consult the boat dealer for recommendations on special bilge cleaning products and procedures.



SECTION
10 **GENERAL CARE AND MAINTENANCE**

BILGE PUMP

Periodically check the bilge pump(s) inlet screens and hoses for obstructions and debris. Foreign materials can clog the screen and hoses or become lodged in the bilge pump impeller, which can cause the pump to malfunction. Periodically check the operation of the bilge pump and float switch, if equipped. Inspect all wiring, clamps and hoses for tightness on a regular basis.

SAFETY EQUIPMENT

Periodically check the safety equipment for damage, general condition and operation when applicable. Always replace safety equipment that is in question or in need of repair:

- Fire extinguisher
- Life jackets
- Visual distress signaling devices
- Audible signaling devices
- Navigational lights
- Emergency radios or Emergency Position Indicating Radio Beacon (EPIRB)
- First aid kit
- Batteries in electronic devices

GENERAL BOATING EQUIPMENT

Periodically check the general equipment on board for damage, general condition and operation when applicable. Always replace equipment that is in question or in need of repair.

- Anchors and anchor lines
- Boat hook
- Dock fenders
- Foul weather gear/clothing
- Mooring lines
- Oars/paddles
- Tool kit
- Tow line



TRAILER

Periodically check the general trailer components for damage, general condition and operation when applicable. Always replace trailer components that are in question or in need of repair.

- Lights
- Electrical connectors
- Tires (condition and pressure)
- Wheel lug nuts and studs
- Wheel valve stems
- Wheel bearings
- License plate and holder
- Rollers, bunks and hardware
- General fasteners (missing, loose or corroded)
- Safety chains or straps
- Winch, winch strap and hooks
- Trailer coupler and latch
- Frame, axle and springs
- Spare tire and wheel
- Brakes and actuator assembly



SECTION
10 GENERAL CARE AND MAINTENANCE

This Page Intentionally Left Blank

Section 11

WINTERIZATION AND STORAGE

The boat may be equipped with a variety of specialized systems and components. The following basic and typical information may not apply to your specific application. This section may not cover all systems or components on the boat. Consult the boat dealer for assistance.

Winterizing or storing the boat for extended periods of non-use requires special preparation to prevent boat and system damage. Without proper preparation, if the boat is not used or is stored for extended periods of time, internal parts of the engine may become corroded from lack of lubrication. If the boat is stored in freezing temperatures, water inside the bilge, engine cooling system or boat water systems may freeze and cause damage. Be sure to keep up with all annual maintenance during winterization.

Before performing any winterization and storage procedures within this section, review *Safety in Section 2*.

WINTERIZATION AND STORAGE PREPARATION

The following procedures will help prevent damage to the boat:

- While the boat is still in the water, fill fuel tank(s) with fresh fuel and add the proper amount of fuel stabilizer/conditioner according to the engine manufacturer's recommendations. Operate the boat for at least 15 minutes to be sure that the treated fuel has reached the engine.

NOTICE

If you plan to store the boat for more than three months in either a humid environment, extreme temperatures or outdoors, "fog" the engine with a corrosion-preventing fogging oil according to the propulsion system manufacturer's recommendations. See the Engine Operator's Manual for more information.

- Once the boat is removed from the water, remove the bilge drain plug immediately. Store the drain plug in a plastic bag and tape it to the throttle control lever for easy accessibility the next time you use the boat.
- Inspect all sacrificial corrosion protection anodes for excessive wear and replace as necessary.
- Check all thru-hull fittings and other fasteners for tightness and leakage.
- Thoroughly clean the hull, deck and interior of the boat as soon as you remove it from the water; marine growth is easier to remove when it is wet.
- Always allow all boat compartments to air dry for a couple of days to prevent mildew from trapped moisture. If you use shrink wrap, always allow for ventilation to prevent mildew from trapped moisture.



WINTERIZATION AND STORAGE

- Apply a coat of wax to the entire surface of the boat and rust inhibitor on all metal parts.
- Clean all traces of dirt, oil, grime and grease from the engine and bilge.
- After washing, raise the bow of the boat high to allow as much water as possible to drain while performing other storage preparations.
- Touch up areas where paint has been removed.
- Prepare the engine for storage according to the *Engine Operator's Manual*. Flush the engine cooling system with clean water and/or a nontoxic antifreeze mixture approved for marine use. Never exceed the maximum engine rpm for flushing recommended as stated in the manual.
- Perform all scheduled maintenance for the engine and boat equipment. See the *Engine Operator's Manual* and all equipment manufacturer's information for periodic and annual maintenance procedures.
- Turn off all electrical switches and breakers.
- Remove all batteries from the boat. Clean, fully charge and store the batteries in an area outside the boat not subject to freezing temperatures. Never store batteries close to heat, sparks or open flames.
- Clean all interior upholstery, furniture, appliances, etc.
- Pest/rodent repellents may help prevent damage to the boat during storage.

STORING ON A CRADLE OR BLOCKS

- When storing a boat on support other than the proper trailer, make sure the hull is supported properly to prevent hull damage. Most cradles are custom-built to support the boat's hull.
- Put the cradle or blocks on a hard, level surface capable of supporting the combined weight of the cradle and the boat.
- When using blocks with jack stands, always use jack stands that are rated for more than the required load, making sure they are securely positioned so they cannot move under the load. Use a minimum of three blocks to support the keel and each side of the boat where applicable. Use a minimum total of nine jacks and/or blocks.
- Position the boat to allow for adequate draining from rain or snow.
- Cover the boat to prevent the collection of rain, snow or debris. When using a cover, allow ventilation for residual moisture and condensation to escape. Never cover or plug the bilge drain hole.
- Position the lower unit drive in the DOWN position.



STORING ON A TRAILER

- Be sure the trailer supports are adjusted to properly support the boat's hull.
- Repack the trailer wheel bearings with water-resistant wheel bearing grease.
- Park the trailer and boat in a protected area with the lower unit drive in the DOWN position.
- Loosen tie-downs and winch line, but be sure the boat is resting properly on hull supports.
- Lift the trailer and place blocks under the trailer frame to relieve weight on trailer tires and springs. Position the boat to allow for adequate draining from rain or snow.
- Cover the boat to prevent the collection of rain, snow or debris. When using a cover, allow ventilation for residual moisture and condensation to escape. Never cover or plug the bilge drain hole.

RECOMMISSIONING AFTER STORAGE

- Remove blocks from under the trailer frame.
- Tighten tie-downs and the trailer winch line.
- Check tire pressure and lug nut tightness on the trailer.
- Inspect the hull for damage.
- Charge and install all batteries.
- Check the bilge blower vents for obstructions and blower operation.
- Check the bilge pump and float switch for proper operation.
- Inspect all battery and electrical wiring for loose connections and/or damage.
- Check the fuel system for leaks or damage. Verify the condition of all hoses and fuel line. Should a fuel hose need replacing, use only USCG-approved hose. Check hose labels for exact type of replacement. Be sure all hose clamps are tight.
- Check the engine and bilge for signs of nesting animals; clean as necessary.
- Check the entire engine for cracks and leaks caused by freeze damage.
- Check the condition of all hoses and clamps for tightness.
- Clean the bilge area and install the boat bilge drain plug.
- Lubricate all seacocks and check for proper operation.
- Install all drain plugs in strainers and seacocks.
- Close all drains and valves that were opened during winterization.



WINTERIZATION AND STORAGE

- Perform any annual maintenance not performed during winterization. See the *Engine Operator's Manual* and all equipment manufacturer's information for periodic and annual maintenance procedures.
- Check the engine's cooling water intake areas and screens for obstructions.
- Check and lubricate the steering system.
- Check all navigational lights.
- Check all controls, gauges, boat systems, accessories and related equipment for proper operation.
- Check all fire extinguishers for charge level.
- Inspect all safety equipment for condition and operation as applicable.
- When possible, briefly start and run the engine(s) using proper water supply equipment to check that the engine does start and there are no major operational problems.

NOTICE

If fogging oil was used during winterization, the engine will emit excessive white smoke upon initial start-up. This condition is normal and will diminish once the fogging oil has been cleared through the engine.

- Once the boat is in the water, start the engine.
- Start the engine(s) and watch the gauge readings closely, checking for leaks and abnormal noises.
- Keep speeds low for the first 15 minutes until the engine has reached normal operating temperature.
- See the *Engine Operator's Manual* and all equipment manufacturer's information for additional recommendations.



LIFTING

NOTICE

Consult the boat dealer for proper lifting instructions for the boat.

Attempt to lift or hoist boats only if you are qualified or experienced with this procedure. This procedure requires special equipment and experience. Do not attempt to lift or hoist the boat alone; damage, personal injury or death can occur.



WARNING

Crush Hazard: Special equipment is necessary to lift the boat and/or engine. Always use lifting equipment with sufficient capacity to lift the boat and/or engine.

If the boat is to be removed from the water without a trailer, follow these guidelines:

- Cover lifting cables with a rubber hose or other protectors to prevent damage to the finish.
- Attach guidelines to the bow and stern to control movement.
- Use spreader bars and keep lifting pressure vertical to prevent side load damage.
- Keep the bow slightly higher than the stern to prevent engine damage.

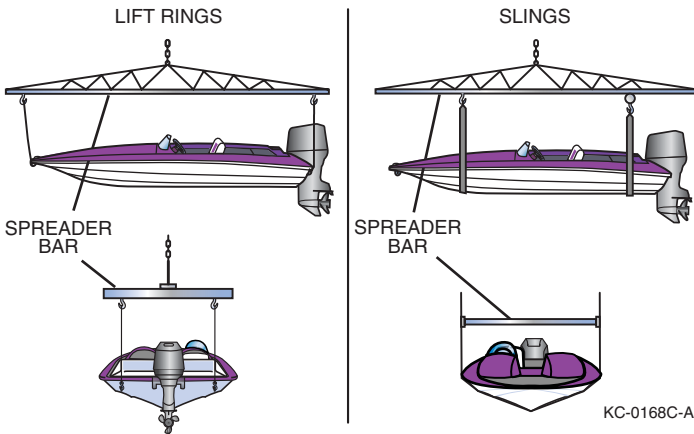



SECTION

11

WINTERIZATION AND STORAGE

This Page Intentionally Left Blank

Section 12

TROUBLESHOOTING

The following information will assist you in identifying basic performance, mechanical and electrical problems. This information is intended as a general troubleshooting guide and may describe items that are not applicable to the boat.

If you detect a problem with the engine, see the *Engine Operator's Manual*. If you detect an equipment or boat system problem, see the manufacturer's information for that item.

Before performing any troubleshooting procedures within this section, review *Safety in Section 2*.

NOTICE

Certain problems may require specialized skills and tools. Always consult qualified personnel before making any repairs or modifications.

PROBLEM	POSSIBLE CAUSES
Engine will not crank	<ul style="list-style-type: none"> • Engine emergency stop switch lanyard not connected • Shift/throttle control not in the NEUTRAL position • Main circuit breaker open • Battery switch is in the OFF position • Battery terminals or wiring connections corroded • Low battery voltage • Faulty ignition switch • Engine problem
Engine cranks but will not start	<ul style="list-style-type: none"> • No fuel in tank • Fuel tank valves closed to engine • Fuel filter clogged • Flame arrestor dirty, if equipped • Contaminated fuel • Engine problem



PROBLEM	POSSIBLE CAUSES
Poor boat performance	<ul style="list-style-type: none">• Contaminated fuel• Uneven load distribution• Excessive load• Improper power trim position• Improper trim tab position• Improper propeller selection• Excessive water in bilge• Damaged or obstructed propeller• Marine growth on hull• Damaged hull• Engine system problem• Plugged flame arrestor, if equipped
Throttle/shifting control problems	<ul style="list-style-type: none">• Corroded cable• Excessive bends or kinks in cable• Engine system problem
Excessive vibration	<ul style="list-style-type: none">• Damaged or obstructed propeller• Bent propeller shaft• Engine system problem
Electrical problems	<ul style="list-style-type: none">• Blown fuse/breaker or open circuit• Loose or corroded wiring connections• Defective switch or gauge• Weak or discharged battery• Loose shore power connection
Erratic or no speedometer reading	<ul style="list-style-type: none">• Disconnected, kinked or plugged pickup tube or pitot• Speedometer gauge faulty

GLOSSARY OF NAUTICAL TERMS

ABOARD – On or in the boat.

ABYC – American Boat and Yacht Council, Inc.

AFLOAT – On the water.

AFT – Toward the rear or stern of the boat.

AGROUND – Touching bottom.

AMIDSHIP – Center or middle of the boat.

ANCHOR – (1) An iron casting shaped to grip the lake bottom to hold the boat.

(2) The act of setting the anchor.

ASHORE – On the shore.

ASTERN – Toward the stern.

BAIL – To remove water from the bottom of the boat with a pump, bucket, sponge, etc.

BAITWELL – A miniature livewell used to store and keep live bait alive and healthy.

BEAM – The widest point on the boat.

BEARING – Relative position or direction of an object from the boat.

BILGE – The lowest interior section of the boat hull.

BILGE KEELS – The raised areas or aluminum extrusions on the bottom of a boat that parallel the keel.

BOARDING – To enter the boat.

BOUNDARY WATERS – A body of water between two areas of jurisdiction; i.e., a river between two states.

BOW – The front of the boat.

BULKHEAD – Vertical partition (wall) in a boat.

BUNKS – Carpeted trailer hull supports.

BURDENED BOAT – Term for the boat that must “give-way” to boats with the right-of-way.

CAPACITY PLATE – A plate that provides maximum weight capacity and engine horsepower rating information. It is located in full view of the helm.

CAPSIZING – To turn over.

CAST-OFF – To unfasten mooring lines in preparation for departure.

CENTER LINE – A lengthwise imaginary line which runs fore and aft with the boat’s keel.

CHINE – The point on a boat where the side intersects (meets) the bottom.

CLEAT – A deck fitting with ears to which lines are fastened.

CONSOLE – Also called helm. The steering wheel area of the boat.

CRANKING BATTERY – The main battery used for engine starting and electrical circuits.

CURRENT – Water moving in a horizontal direction.

DECK – The open surface on the boat where the passengers walk.

DEEP-CYCLE BATTERIES – Special long-running batteries which can be repeatedly discharged and recharged without significant loss of power.

DOLLY WHEEL – A rolling jack assembly at the front of the trailer used for positioning the coupler during trailer hookup.

DRAFT – The depth of the boat below the waterline, measured vertically to the lowest part of the hull.

ELECTROLYSIS – The breakup of metals due to the effects of galvanic corrosion.



FATHOM – Unit of depth or measure; 1 fathom equals 6 feet.

FENDERS – Objects placed alongside the boat for cushioning. Sometimes called bumpers.

FORE – Toward the front or bow of the boat. Opposite of aft.

FREEBOARD – The distance from the water to the gunwale.

FUEL SENDING UNIT – The electrical device that is mounted on the outside of a built-in fuel tank and controls the dashboard fuel gauge.

GIVE-WAY BOAT – (1) Term for the boat that must take whatever action necessary to keep well clear of the boat with the right-of-way in meeting or crossing situations. (2) The burdened boat.

GUNWALE – The rail or upper edge of a boat's side.

HEAD – A marine toilet.

HELM – The steering wheel or command area.

HULL – The body of the boat.

HYPOTHERMIA – A physical condition where the body loses heat faster than it can produce it.

IN-LINE FUSE – A type of protective fuse located in the power wire of a direct current (DC) circuit usually near the battery.

KEEL – The lowest portion of the boat; extends fore and aft along the boat's bottom.

LIFE JACKET – A buoyant, wearable jacket that, when properly used, will support a person in the water; also see PFD.

LIST – Leaning or tilt of a boat toward the side.

MAKING WAY – Making progress through the water.

MARINE CHART – Seagoing maps showing depths, buoys, navigation aids, etc.

MOORING – An anchor, chain or similar device that holds a boat in one location.

NAVIGATION AID – Recognizable objects on land or sea such as buoys, towers or lights which are used to fix position to identify safe and unsafe waters.

NMMA – National Marine Manufacturers Association.

NO-WAKE SPEED – The speed at which a boat travels to produce an imperceptible wake.

PFD – A buoyant personal flotation device used to support a person in the water; also see Life Jacket.

PITOT TUBE – See Speedometer Pickup Tube.

PLANING HULL – A hull designed to lift, thereby reducing friction and increasing efficiency.

PORPOISE – A condition in which the bow bounces up and down caused by trimming the engine too far out.

PORT – (1) The left side of a boat when facing the bow. (2) A destination or harbor.

PRIVILEGED BOAT – Term used for the boat with the right-of-way.

RIGHT-OF-WAY – Term for the boat that has priority in meeting or crossing situations. The stand-on or privileged boat.

RULES OF THE ROAD – Regulations for preventing collisions on the water.



SPEEDOMETER PICKUP TUBE – Also called pitot tube. The plastic device that extends below the bottom of the boat. It connects to the speedometer with plastic flexible tubing.

SPLASHWELL – The section of an outboard-equipped boat that is just forward of the transom.

STAND ON BOAT – Term for the boat that must maintain course and speed in meeting or crossing situations. The privileged boat.

STARBOARD – The right side of the boat when looking toward the bow.

STERN – The back of the boat.

STOW – To pack the cargo.

SURGE BRAKES – A type of trailer braking system designed to automatically actuate when the tow vehicle's brakes are applied.

TRANSDUCER – The unit that sends/receives signals for the depth sounder.

TRANSOM – The transverse beam across the stern.

TRIM – Fore to aft and side to side balance of the boat when loaded.

UNDERWAY – Boat in motion; i.e., not moored or anchored.

USCG – United States Coast Guard.

WAKE – The waves that a boat leaves behind when moving through the water.

WATERWAY – A navigable body of water.

V-PAD – A modified vee-hull design with a small, flat area in the keel aft.

VISUAL DISTRESS SIGNAL – A device used to signal the need for assistance such as flags, lights and flares.



SECTION
13 **GLOSSARY OF NAUTICAL TERMS**

This Page Intentionally Left Blank

WARRANTY

790 Markham Drive P.O. Box 1010



Pulaski, WI 54162 920.822.3214

LARSON BOATS, LLC LIMITED WARRANTY

LARSON BOATS, LLC, ("Larson") producer of Larson, Larson FX, Larson Escape and Striper boats warrants to you, the first retail purchaser beginning with a new 2019 model year boat bought from a factory authorized dealer, that it will repair or replace defects in materials or workmanship that occur and are reported to your factory authorized dealer within the applicable Warranty Periods set forth below, subject to the terms, conditions and exclusions ("What This Warranty Does NOT Cover") set forth below. Your acceptance of delivery of the warranted boat constitutes your acceptance of the terms of this limited warranty. All warranty periods run from the date (the "Effective Date") of delivery to the original retail owner (the "Owner"), or twelve (12) months from the date the yacht was delivered to the Larson dealer, whichever is earlier. This limited warranty applies only to covered defects first arising and reported to Larson or its authorized dealer within the applicable warranty coverage period.

U.S. purchasers: this warranty gives you specific legal rights, and you may also have other rights which vary from state to state. E.C. purchasers: the owner has legal rights under applicable national legislation and the Consumers Protective Directive 1999/44/EC of the European Parliament and of the Council of 25 May 1999 governing the sale of consumer goods, and those rights are not affected by this limited warranty. Any claim that the yacht was nonconforming at the time of delivery must be made within two (2) years from the date of delivery.

WHAT THIS WARRANTY COVERS:

Structural Warranty: Structural fiberglass defects in workmanship and materials in the hull, deck, stringers, transom, pontoon platform, tubes, motor pod causing the boat to be unfit for general use as a pleasure craft under normal conditions of operation - Limited Original Purchaser's Ten (10) years.

Component Warranty: For defects in workmanship and materials in factory manufactured and installed non-structural parts and components - Five (5) year Limited Warranty.

Gelcoat Warranty: Defects in factory materials and workmanship that result in osmosis blistering of the exterior gel coat surface of the hull are warranted for five (5) years Limited Warranty.

The applicable Warranty Period runs from the date of delivery of the boat to the first retail customer, and warranty coverage applies only to warranted claims that first arise and are reported to Larson within the applicable warranty period. This warranty extends only to the first retail purchaser, but certain limited warranty coverage may be transferred to a second owner of a used boat who buys it for personal use from a factory authorized dealer (or directly from the first retail purchaser) by completing a Warranty Transfer Application and payment of a transfer fee of \$500, provided an inspection report by an accredited marine surveyor. Transferred warranty coverage is limited to structural defects in the hull (limited to 10 years from the effective date of the original warranty coverage) and factory manufactured and installed non-structural parts and components and gelcoat coverage (limited to two (2) years from the effective date of the original warranty coverage), and is subject to the remaining terms, conditions and exclusions set forth herein. The Warranty Transfer Application and transfer fee must be received by the factory within 30 days of purchase by the Second Retail Purchaser. Larson reserves the right to reject a warranty transfer request for a Larson that has been damaged, improperly maintained or otherwise previously excluded from warranty. Proof of purchase is required. The warranty may only be transferred once.

The express limited warranty described above is the sole and exclusive express warranty from Larson. **Under the laws of certain states, there may be no implied warranties or conditions from Larson applicable to your boat, and all implied warranties (INCLUDING ANY IMPLIED WARRANTY OF MERCHANTABILITY OR FITNESS FOR A PARTICULAR PURPOSE) and conditions are excluded and disclaimed from warranty coverage where allowed by law. Any IMPLIED WARRANTIES (if any) arising under applicable law are LIMITED IN THEIR DURATION TO TWO (2) YEARS FROM THE EFFECTIVE DATE.**

MARQUIS BLARSON LARSONFX ESCAPE STRIPER CARVER



WARRANTY

790 Markham Drive P.O. Box 1010



Pulaski, WI 54162 920.822.3214

ALL IMPLIED WARRANTIES, if any, INCLUDING MERCHANTABILITY or FITNESS FOR A PARTICULAR PURPOSE ARE EXCLUDED AND DISCLAIMED IN THEIR ENTIRETY AFTER TWO (2) YEARS FROM THE EFFECTIVE DATE. There are no warranties which extend beyond the description on the face hereof. **Some states do not allow limitations on how long an implied warranty lasts, so the above limitation may not apply to you.**

WHAT THIS WARRANTY DOES NOT COVER:

Larson does not provide any warranty coverage, nor have any liability or responsibility, for any defects, costs, expenses or damages relating to the following:

- The failure to use, maintain or store the boat as specified in the manuals supplied to the Owner
- A boat purchased from anyone other than an authorized dealer.
- A boat, including its components, that has been altered, modified or not properly maintained.
- A boat, including components and systems, that has been altered or modified from factory specifications; equipment and accessories not factory installed by Larson;
- Engines, outdrives, controls, propellers, batteries, generators, appliances, air conditioners, stereos and other equipment or accessories that are not manufactured by Larson. It is the owner's obligation to fulfill any warranty registration and other obligations as to any third-party manufacturer's warranty coverage, and to submit any warranty claims directly to the third-party warrantor. Note: it is the Owner's responsibility to complete any OEM warranty registration procedure that may be applicable;
- Non-structural parts and components manufactured or installed by third parties, whether or not warranted by other manufacturers.
- The cost of removal or reinstallation of parts or disassembly of units to repair or replace components covered by this limited warranty.
- Any boat which has been in an accident, misused, used in a negligent manner, used for racing, used for rental, charter, demo, military, rescue, fire, safety, medical, police, law enforcement, patrol, or other governmental or commercial purposes, operated contrary to any instruction furnished by Larson, or operated in violation of any governmental or agency laws, rules or regulations.
- Any representation relating to speed, range, fuel consumption or other estimated performance characteristic.
- Loss of time, inconvenience, boat payments, retail charges, improper lifting or trailering, travel expenses, loss of use, in-and-out-of-water charges, towing and storage charges, loss of or damage to personal property, or other remedies not specifically allowed.
- Damage from osmosis blistering if the original gel surface has been altered in any way;
- Damage or deterioration of cosmetic surface finishes, including corrosion, cracking, crazing, discoloration, fading or oxidation of gel coat and painted fiberglass surfaces, wood finishes (varnishes, stains and paints), fabrics, plated or painted metal and stainless steel finishes; anti-fouling bottom paint or zinc anodes;
- The cost to remove, disassemble or reinstall components not installed by Larson that require removal to access parts covered by this limited warranty;
- Dealer preparation, cleaning, final adjustments and alignments in preparing the boat for delivery or commissioning.
- Normal and routine maintenance and wear and tear, including leakage around windshield, hatches, canvas, or other designated openings.
- Window glass and windshield damage, leaks or breakage; damage, shrinkage or deterioration of carpet, upholstery, and exterior canvas tops, enclosures, and weather covers;
- Fit and adjustment of exterior canvas tops, enclosures and weather covers.
- Sacrificial deterioration of anti-fouling paint or zinc anodes.
- Cosmetic and/or damage resulting from normal wear and tear, or improper care and maintenance, either by dealer prior to consumer purchase or by consumer are not covered.

MARQUIS BLARSON LARSONFX ESCAPE STRIPER CARVER



790 Markham Drive P.O. Box 1010

Pulaski, WI 54162 920.822.3214

**REMEDIES AND OTHER INFORMATION:**

Your **sole and exclusive remedy** (including any applicable implied warranty) is the repair or replacement, at Larson sole option, of parts and components covered by this warranty, **and does not include incidental or consequential damages which are specifically DISCLAIMED and EXCLUDED from warranty coverage.** U.S. purchasers: some states do not allow the exclusion or limitation of incidental or consequential damages, so the above limitation or exclusion may not apply to you. Any legal action alleging a breach of warranty must be brought within one (1) year from the date the alleged breach first occurred, regardless of the time remaining in the applicable warranty period. The boat, including any alleged defective part, must be returned to an authorized dealer (or as otherwise directed by Larson) within the applicable warranty period to obtain warranty service. The authorized dealer will carry out the warranty procedures on the owner's behalf. All warranty work will be performed at an authorized dealer, another repair facility that Larson selects, or the factory, at Larson's option. The owner is responsible for the expense associated with transporting the boat to and from the repair facility.

This document contains the entire warranty given by Larson and there are no terms, promises, conditions or warranties regarding your Larson yacht other than those contained herein. Larson reserves the right to change Larson specifications, features, and prices without prior notification and without obligation for Larson yachts previously manufactured.

Your acceptance of delivery of the warranted Larson yacht constitutes your acceptance of the terms of this limited warranty. Your Larson dealer is an independent business, and is not the agent of Larson. Your Larson dealer may not modify or change the terms of this limited warranty, and any questions concerning the scope of this limited warranty coverage should be addressed directly to Larson. Neither your Larson dealer nor anyone else is authorized to extend the time or scope of this warranty, or to create or assume for Larson Yachts any other obligation or liability with respect to Larson Yachts or this warranty.

Any legal action alleging a breach of this warranty (or any implied warranty) must be brought within one (1) year from the date the alleged breach first occurred. The exclusive jurisdiction and venue for any court action commenced by you under or relating to this limited warranty or any implied warranty(ies) shall be in the Circuit Court for Brown County, Wisconsin or United States District Court for the Eastern District of Wisconsin.

We may be contacted as follows: Larson Boats, LLC, Attention: Customer Service Department, 790 Markham Drive, P.O. Box 1010, Pulaski, Wisconsin 54162, USA. +1-920-822-3214.

MARQUIS *LARSON* LARSONFX ESCAPE  STRIPER CARVER



WARRANTY

This Page Intentionally Left Blank

INDEX

Numerics

5-pin wiring connector 8-5

A

Accelerating and running
underway 7-12
Accidents 3-2, 4-7
Alcohol 3-3
Aluminum 10-10
American Boat & Yacht Council 1-5
American Red Cross 1-5
Anchor 7-19
Anchor line 7-19
Anchors and anchoring 7-19
Anodes 10-7, 11-1
Antifouling bottom paint 10-11
Aquatic Invasive Species (AIS) 3-8
Aquatic vegetation/weeds 5-3
Audible (sound) signals 2-24, 6-2
Audible alarms 9-13
Audible signaling
devices 2-16, 2-24

B

Backing up 8-9
Basic safety rules 2-1
Battery 9-7, 9-14
Battery isolators 9-7
Battery switches 9-14
Bell 6-2
Bilge 10-15
Bilge pump 9-17, 10-16
Bilge pump switch 9-16
Bilge pump system 9-17
Boarding 7-3
Boarding switches 9-16
Boat loading 7-4
Boat Owners Association of The United
States 1-5
Boat system failure 4-6
Boat ventilation system 9-17
Boating accident 3-2
Boating regulations 3-1, 6-1
Boating under the influence 3-3

BoatU.S. Foundation for
Boating Safety Hotline 1-5
Buffing 10-12
Buoys 6-6, 6-9, 6-10, 6-11, 6-12

C

Canvas 10-13
Canvas cover 10-13
Capacity plate 7-4
Capsizing and flooding 4-5
Carbon monoxide poisoning 2-32
Carpet 10-14
Charging system 9-7
Circuit breakers 10-5
Cleaners 10-10, 10-12
Cleaning 10-11
Cleaning agents 3-9
Cold water 5-2
Cold weather and cold or
frozen water conditions 5-2
Collision 4-7
Communication equipment 4-1
Compass 9-13
Compliance plate 1-3
Cooling system 10-6
Corrosion 10-6, 10-10
Courtesy switches 9-16
CPR 4-1
Crossing 6-5
Cruising limitations 2-31

D

Dams 5-3
Dams and spillways 5-3
Danger signal 6-2
Daymarks 6-10
Daymarks/Dayboards 6-7
DC system 9-7
Debris 5-3
Diameter 9-8
Distress signal 3-4
Distress signaling devices 4-1
Distress signals 6-2
Docking 7-17
Drain plug 11-1



Drugs 3-3
Dual-prop drives 9-9

E

Electric supply 9-7
Electric trolling motor systems 9-23
Electrical system 9-6
Electrolysis 10-6
Emergencies 4-1, 4-7
Emergency assistance 3-4
Emergency checklist 4-1
Emergency stop switch 9-15
Emissions 3-9
Engine cooling system 9-2, 11-2
Engine hour meter 9-12
Engine lubrication system 9-2
Engine warning alarm system 9-13
Engine water temperature
gauge 9-12
Exhaust emissions 3-9

F

Fasteners 10-10
Fire and explosion 4-3
Fire extinguishers 2-17, 2-18
Fires 2-18
First aid/medical emergencies 4-1
Fishing 3-5
Flags 5-4
Float plan 7-1
Float switch 10-16
Fog conditions 5-2
Fogging oil 11-1
Freezing temperatures 11-1
Fuel (gasoline) 7-5, 7-6, 10-1
Fuel filler 7-7
Fuel level gauge 9-11
Fuel management 7-5
Fuel stabilizer 11-1
Fuel suppliers 7-5
Fuel system 9-1, 10-1
 Fuel 10-1
 Fuel filter 10-1
 Fuel tanks 9-1

Fueling 7-5, 7-6, 7-7
Fuses 10-4

G

Galvanic corrosion 10-6, 10-11
 Anodes 10-6
Gauges 9-10
Gauges/Instruments 9-10
Gelcoat 10-12
General boating equipment 10-16
Glossary of nautical terms 13-1
Green light 6-2
Gross Vehicle Weight Rating
(GVWR) 8-2

H

Hazard information 2-31
Hazard labels 2-4
Hazards 5-2, 5-4
Helm 7-9, 9-4
Helm and control switches 9-14
Hitch ball 8-2
Hitch ball and trailer coupler 8-3
Horn 6-2
Horn switch 9-16
Hull identification number 1-2
Hypothermia 4-1, 5-2

I

Icy waters 5-2
Ignition switch 9-14
Inclement weather 5-2
Insurance 3-2

L

Lanyard 9-15
Lateral markers 6-10
Launching 8-9
Law of salvage 4-3
Life jackets 2-16
Lifting 11-5
Lighthouses 6-8
Lights 9-16
Lights and lighted structures 6-7
Lights switch 9-16



Lines and knots 7-21
 Loading 8-11
 Loading guidelines 8-11

M

Maintenance 10-1
 Man Overboard (MOB) 4-4
 Manatee 6-12
 Marine Assistance Request
 Broadcast (MARB) 4-2
 Marine growth 10-11
 Markers 6-6, 6-12
 Markers, warnings and
 advisories 5-4
 MARPOL treaty 3-8
 Mayday 4-2
 Medical emergencies 4-1
 Meeting head-on 6-4
 Mildew 10-12
 Minimum on-board personal
 safety equipment 2-16
 Minor lights 6-10
 Minors 3-3
 Monofilament fishing line 3-6
 Mooring 7-18
 Mooring buoys 6-7
 Mooring line 7-18
 Multi-gauges 9-10

N

National Association of State
 Boating Law Administrators 1-5
 National Marine Manufacturers
 Association 1-5
 National Oceanic and
 Atmospheric Administration's
 National Weather Service 1-5
 National Safe Boating
 Council Inc. 1-5
 Nautical terminology 1-2
 Navigation lights switch 9-16
 Navigation markers 5-4
 Navigational lights 2-25
 Navigational lights and night
 operation 6-1

Navigational rules 6-1
 Negligent operation 3-4
 Neutral start safety switch 9-15
 Noise 3-6

O

Observer 2-34
 Oil level 9-13
 Oil level gauge 9-13
 Operating under the influence 3-3
 Operation by minors 3-3
 Organizations 1-4
 Outboard engine fueling
 considerations 7-8
 Overboard dumping 3-8
 Overtaking/passing 6-3

P

Paints 3-9
 Passengers 7-9
 Performance 7-4
 Pitch 9-8
 Planing 7-12
 Platform dragging 2-32
 Power trim and tilt 7-14
 Power trim operation 7-14
 Pre-departure safety checklist 7-2
 Propeller 9-8, 9-9
 Proposition 65 3-9
 Protecting the boat from theft 4-9
 Protecting the environment 3-7
 Publications 1-4

R

Range lights 6-8
 Range markers 6-9
 Red light 6-2
 Reduced visibility 5-2
 Registration 3-2
 Registration certificates 3-2
 Registration numbers 3-2
 Regulations 3-3, 3-6, 3-7, 3-9
 Regulatory markers 6-9
 Reporting accidents 4-7
 Reporting safety defects 8-12



Requesting assistance
(non-distress call) 4-2
Restricted areas 3-4
Restricted visibility 6-1
Right-of-way 6-1
Rotational thrust 7-10
Running aground 4-6

S

Safe water markers 6-11
Safety 7-4
Safety chains 8-4
Safety decals 2-4
Safety equipment 7-1, 10-16
Safety guidelines 2-2
Safety precautions 2-9
Safety standards 1-3
Salt water 10-6
Saltwater corrosion 10-6
Sea Tow Services
International, Inc. 1-5
Seals in the engine lower unit 3-6
Security zones 3-4
Severe weather 5-1
Shallow water 5-3
Shallow water boat stability 3-7
Shallow water operation 5-3
Shift and throttle controls 9-4
Shift controls 9-6
Shifting 7-12, 9-5, 9-6
Shock 5-2
Signs 6-12
Single-lever controls 9-5
Special markers 6-10
Speed 3-7
Speed limits 3-7
Speedometer 9-11
Spillways 5-3
Spotter 2-34
Starting 7-9
Static electricity and the fuel
system 7-5
Steering 7-9
Steering system 9-3
Stopping 7-11

Storing 11-1
Storm conditions 5-1
Storm warning 5-4
Surge brakes 8-5
Switches 9-14

T

Tachometer 9-10
Teak 10-14
The general prudential rule 6-1
Throttle 9-4, 9-5
Throttle controls 9-4
Thru-hull fittings 11-1
Towing 4-6
Towing hitch 8-2
Towing on the water 4-7
Towing vehicle 8-2
Trailer 8-1, 10-17
Trailer brakes 8-5
Trailer classification 8-1
Trailer regulations 8-1
Trailer type 8-1
Trailering guidelines 8-6
Type B fire extinguishers 2-18

U

U.S. Coast Guard (USCG) 1-6, 3-1
U.S. Coast Guard Auxiliary 1-6
U.S. Coast Guard Navigation
Center (NAVCEN) 1-6
U.S. Coast Guard Office of
Boating Safety 1-6
U.S. Coast Guard's America's
Waterway Watch Program 1-6
U.S. Government Printing Office ... 1-6
U.S. Power Squadrons 1-6
Unapproved lighting 2-25
United States Aids to Navigation
System (USATONS) 6-6
Upholstery 10-12
USCG safety standards 1-3

V

Vegetation 5-3
Vinyl cleaner 10-12
Visibility 5-2



Visual distress signaling	
devices	2-16
Visual distress signals (VDS)	2-23
Voltmeter	9-12

W

Wake	3-6
Washing	10-12
Waste	9-17
Water depth gauge	9-13
Water hazards	5-2
Water sports	2-32
Water sports guidelines	2-33
Weather	4-6
Whistle	6-2
Window channels	10-14
Windshield	10-14
Winterization and storage	
Winterizing	11-1



SECTION
I

INDEX

This Page Intentionally Left Blank

