

CANADA VERSION



POLARIS

GENERAL

2019

ACCESSORIES + APPAREL



ANY TASK. ANY TRAIL.



View this Polaris GENERAL® & make it your own
POLARIS.COM/GENERALtrail

INDUSTRY LEADER

Combining unmatched power for off-road adventure and versatile features to take on any task and any trail.

POLARIS
GENERAL

POLARIS.COM/ShopGENERAL

2019 LINEUP

BASE

POLARIS GENERAL® 1000



- 100 HP PROSTAR® ENGINE
- 600 LB. DUMPING BOX
- STANDARD HALF DOORS
- ELECTRONIC POWER STEERING (EPS)
- POLARIS® LOCK & RIDE® COMPATIBLE
- VERSATRAC TURF MODE

PREMIUM

POLARIS GENERAL® 1000 PREMIUM



- BASE PLUS:**
- AUTOMOTIVE PAINT
 - MATTE BLACK CAST ALUMINUM WHEELS
 - 27" MAXXIS® CORONADO TIRES
 - SPORT LOW PROFILE FRONT BUMPER
 - POLARIS® HD 4500 LB. WINCH

POLARIS GENERAL® 1000 HUNTER EDITION



- PREMIUM PLUS:**
- LOCK & RIDE® DUAL GUN BOOT
 - 2 POLARIS® GUN BOOTS BY KOLPIN®
 - POLARIS® PURSUIT® CAMO

POLARIS GENERAL® 1000 LIMITED EDITION



- ADDITIONAL FEATURES:**
- CUSTOM BREAKOUT CAMO GRAPHICS
 - COLOR MATCHED SPORT LOW PROFILE FRONT BUMPER
 - COLOR MATCHED ROCK SLIDERS

DELUXE

POLARIS GENERAL® 1000 DELUXE



- PREMIUM PLUS:**
- FOX® PODIUM X 2.0 QS3 SHOCKS
 - SPORT ROOF
 - MTX® PREMIUM SOUNDBAR
 - CONVEX REAR VIEW MIRROR
- Now Available in Two Color Packages

POLARIS GENERAL® 1000 RIDE COMMAND® EDITION



- DELUXE PLUS:**
- RIDE COMMAND® 7" GLOVE-TOUCH DISPLAY
 - FRONT & REAR WIRED CAMERAS
 - GPS MAPPING
 - BLUETOOTH® PHONE CONNECTIVITY

4-SEAT

POLARIS GENERAL® 4 1000



- BASE PLUS:**
- AUTOMOTIVE PAINT
 - MATTE BLACK CAST ALUMINUM WHEELS
 - 27" DIRT COMMANDER 8-PLY TIRES
 - FOX® PODIUM 2.0 QS3 SHOCKS
 - SPORT LOW PROFILE FRONT BUMPER
 - POLARIS® HD 4500 LB. WINCH

POLARIS GENERAL® 4 1000 RIDE COMMAND® EDITION



- BASE PLUS:**
- SPORT ROOF
 - MTX® PREMIUM 8 SPEAKER SOUNDBAR
 - RIDE COMMAND® 7" GLOVE-TOUCH DISPLAY
 - FRONT & REAR WIRED CAMERAS
 - GPS MAPPING
 - BLUETOOTH® PHONE CONNECTIVITY
 - CONVEX REAR VIEW MIRROR

2019 POLARIS **GENERAL®** **ACCESSORIES**

POLARIS ENGINEERED™	02
WORK & EXPLORE	06
WINDSHIELDS & REAR PANELS	08
DOORS	10
ROOFS & PROTECTION	12
RIDE COMMAND®, POLARIS PULSE®, AUDIO & CAB ACCESSORIES	14
LIGHTING	16
STORAGE	18
POLARIS NORTHSTAR® COOLER	20
WHEELS & TIRES	22
WINCHES & PLOWS	28
PARTS & GARAGE	
OIL & LUBRICANTS	30
MAINTENANCE	34
SERVICE PARTS	36
POLARIS® POWER	38
GARAGE & TRAILERING	42
APPAREL & HELMETS	
RIDING GEAR	44
CASUALWEAR	46

ALL LISTED PRICES ARE IN CANADIAN DOLLARS



BUILD YOUR OWN
 AT POLARIS.COM/GENERAL

KEEP YOUR STANDARDS HIGH

DESIGNED

POLARIS® OFFERS THE BROADEST LINEUP OF ACCESSORIES AND MOST INNOVATIVE SOLUTIONS IN OFF-ROAD. EACH ONE IS METICULOUSLY CRAFTED TO MATCH YOUR MACHINE.

EARLY DOOR RENDERING

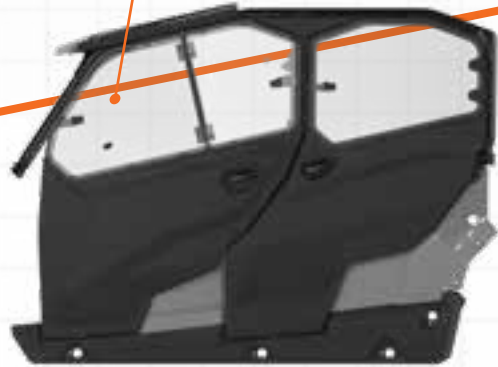

TESTED

BY THE TIME YOU GET THIS GEAR, PROTOTYPES HAVE GONE THROUGH HELL IN OUR LAB AND BEEN EXTENSIVELY TESTED IN THE FIELD. YOU RIDE WITH 100% CONFIDENCE.

TRUSTED

WE'VE EARNED RIDERS' TRUST OVER DECADES AND WE STAND BEHIND OUR WORK. EVERYTHING WITH OUR NAME ON IT COMES WITH A ONE-YEAR WARRANTY.

BACKED BY A



WARRANTY

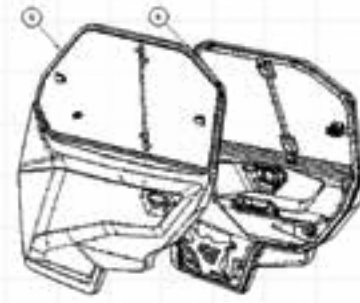

POLARIS® PARTNERS WITH THE BEST

We choose our partners carefully, selecting only the best in off-road. Every accessory is rigorously tested and validated at Polaris® standards, to ensure seamless integration and performance.



PRO ARMOR



WHEELS & TIRES P. 22
LED LIGHTS P. 16



RIGID

LED LIGHTS P. 16

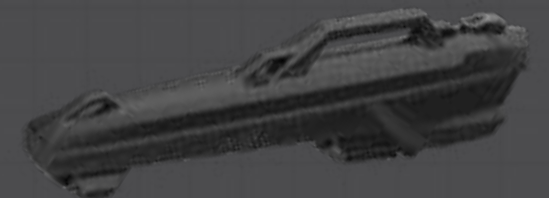

KOLPIN
OUTDOORS

ACCESSORIES P. 19



View this Polaris GENERAL® & make it your own
[POLARIS.COM/GENERALexplore](https://www.polaris.com/general/explore)

ENGINEERED TO TAKE ON THE ELEMENTS

TESTED & PROVEN

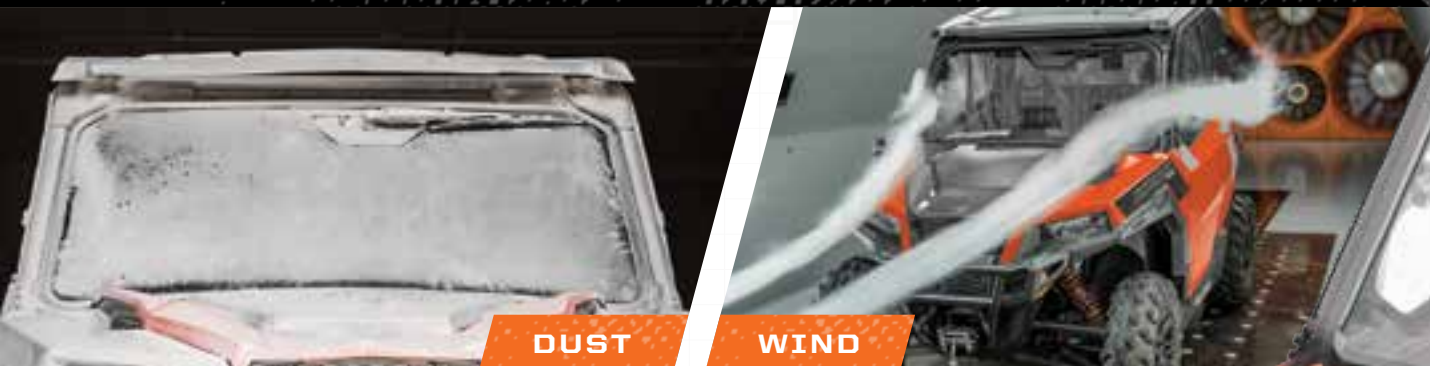

**POLARIS GENERAL® CABS PROVIDE
THE INDUSTRY'S TIGHTEST SEAL**

11x BETTER DUST SEAL
THAN THE CAN-AM® COMMANDER®

**BUILD YOUR CAB SYSTEM
STARTING ON P. 08**

**LUXURY
YOU HAVE TO
EXPERIENCE
TO BELIEVE**

Our cab components create an experience enhancing interior, offering supreme comfort to your vehicle.



PROFILE TUBE DESIGN

Contours built into the cage deliver the best sealing surface in the industry.



PERFECT FIT, PERFECT SEAL

A 360° gasket seal provides the tightest-sealing cab in the industry.



LOCK & RIDE

EASY ON & EASY OFF

Adapt to your needs and environment with exclusive tool-less, easy-on, easy-off Lock & Ride® components.



NEW

PLUG & PLAY ELECTRICAL

**EFFORTLESSLY ADD
LIGHTS, HEAT, WIPERS & AUDIO.**

Be prepared for everything off-road riding & the elements throw at you.

A revolution in electrical accessory integration, the Polaris Pulse™ Electrical System allows for a simple plug & play approach for adding power to Polaris Engineered Accessories™.

Look for  to identify Polaris PULSE™ ready accessories.

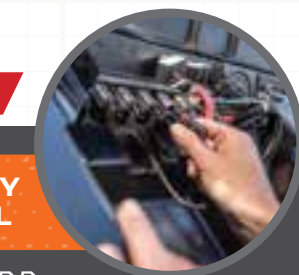
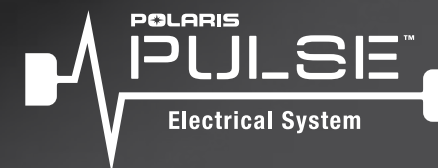

WORK FASTER



LOCK & RIDE
REAR PANEL - POLY
P. 09

SPORT ROOF - POLY
P. 12

LOCK & RIDE
CARGO BOX
P. 19

LOCK & RIDE
FULL WINDSHIELD POLY
P. 08

LOCK & RIDE
BED EXTENDER
P. 18

ZIP WINDOW
UPPER DOORS - CANVAS
P. 11

PRO ARMOR® WHEEL & TIRE SET:
SIXR - MATTE BLACK &
DUAL-THREAT 29" TIRES
P. 23-27



LOCK & RIDE
FLIP-DOWN WINDSHIELD
- HARD COAT POLY
P. 08

PRO ARMOR® DUAL ROW
76cm COMBO
P. 16-17

LOCK & RIDE
REAR PANEL - GLASS
P. 09

SPORT UPPER FRONT
BUMPER
P. 13

SPORT LOW
PROFILE FRONT BUMPER
P. 13

NEW
PREMIUM POLY FULL
DOOR, 4-SEAT
P. 10

POLARIS® PRO HD
2041 kg WINCH
P. 28

RAPID ROPE RECOVERY
5x

PRO ARMOR® WHEEL & TIRE
SET: ATTACK 2.0 28" TIRES
& HALO MATTE BLACK
P. 23-27

EXTREME KICK-OUT
STEEL NERF BARS
P. 13

PREMIUM POLY FULL
DOOR, 2-SEAT
P. 10

EXPLORE FARTHER

View this Polaris GENERAL® & make it your own
[POLARIS.COM/GENERALwork](https://www.polaris.com/GENERALwork)

View this Polaris GENERAL® & make it your own
[POLARIS.COM/GENERALexplore](https://www.polaris.com/GENERALexplore)

SHIELD THE FRONT

CONTROL THE SWIRL

Keep the elements out of the cockpit. The multiple options allow you to choose and control the level of air flow into the cab.

Add a windshield to change the airflow around your vehicle. Turbulent air will form above the cargo bed and behind the cab. This swirl can carry dirt, dust, leaves, and rain into the cab. Eliminate this phenomenon and **control the swirl** by installing a rear panel.

- TIP-OUT WINDSHIELD - GLASS**
» 2881108 • \$1,599⁹⁹
POLARIS GENERAL® 4 '17-19,
POLARIS GENERAL® '16-19
- LOCK & RIDE FULL WINDSHIELD - GLASS TOP SELLER**
» 2881109 • \$929⁹⁹
POLARIS GENERAL® 4 '17-19,
POLARIS GENERAL® '16-19
- FLIP-DOWN WINDSHIELD - HARD COAT POLY**
» 2882174 • \$609⁹⁹
POLARIS GENERAL® 4 '17-19,
POLARIS GENERAL® '16-19
- LOCK & RIDE FULL WINDSHIELD - HARD COAT POLY**
» 2881110 • \$669⁹⁹
POLARIS GENERAL® 4 '17-19,
POLARIS GENERAL® '16-19
- LOCK & RIDE HALF WINDSHIELD - POLY**
» 2881111 • \$269⁹⁹
POLARIS GENERAL® 4 '17-19,
POLARIS GENERAL® '16-19

- LOCK & RIDE REAR PANEL - GLASS TOP SELLER**
» 2881113 • \$469⁹⁹
POLARIS GENERAL® 4 '17-19,
POLARIS GENERAL® '16-19
- LOCK & RIDE REAR PANEL - POLY**
» 2881112 • \$409⁹⁹
POLARIS GENERAL® 4 '17-19,
POLARIS GENERAL® '16-19



TIP-OUT WINDSHIELD - GLASS



The three-position adjustment system easily opens, providing in-cab ventilation.

FLIP-DOWN WINDSHIELD - HARD COAT POLY



Offers fully-sealed or flipped-down venting options. Upper half detaches, leaving lower half for protection with maximum ventilation.

WINDSHIELD WIPER & WASHER SYSTEM



Add to wiper ready windshields for enhanced visibility in tough conditions.

2881090 See page 15



ADD A REAR PANEL TO REDUCE THE DUST SWIRL



Superior **OPTICAL CLARITY** for a clear view. Laminated safety glass **PROTECTS FROM SCRATCHES** and provides automotive-level visibility.

Curved to fit, seals tight, and is wiper ready.

Lightweight and flexible, POLY is **IMPACT-RESISTANT**, providing long-term value and protection. Guarantees a tight seal to keep out rain and dust.

Hard Coat options feature an extra layer on both sides of the poly, which provides **30x MORE** scratch resistance than regular poly windshields.

POLARIS ENGINEERED™ ADVANTAGES



AIRTIGHT GASKET SEAL

Our windshields and rear panels feature 360° airtight gasket seals to keep drafts and moisture out of your cab.



LOCK & RIDE

REVOLUTIONARY INSTALLATION

Windshields and rear panels install easily and lock securely in place using Polaris® Lock & Ride™ technology. Once installed, it removes easily and can be reinstalled without the need for any tools.

COMPLETE YOUR CAB

**11x
BETTER
THAN THE
CAN-AM® COMMANDER®
AT KEEPING DUST OUT**



**REPLACE EXISTING HALF DOORS WITH
PREMIUM POLY FULL DOORS.**

- Impact and scratch-resistant tempered glass
- Fully-sealed design keeps elements out for a premium in-cab environment

- Hinged window adjustability
- Soft-touch, easy to clean premium interior liner

**NEW
REAR**

- Push-out windows
- Kit includes B-pillar cover seal

» 2883082 • **\$3,469⁹⁹**
POLARIS GENERAL® 4 '17-19

FRONT

- Six-way glass window adjustability

» 2883717 • **\$3,269⁹⁹**
POLARIS GENERAL® 4 '17-19
POLARIS GENERAL® '16-19

View this Polaris GENERAL® 6 and make it your own
POLARIS.COM/GENERALexplore



**PREMIUM
FEATURES**

Automotive-like finish, cast handle, solid latches, storage and more.

**A PERFECT FIT FOR
THE PERFECT SEAL**

Polaris Engineered™ cab components nest perfectly into the contours of the cab frame with a 360° degree gasket seal.

Polaris GENERAL® comes equipped with half doors. To create an enclosed cab for increased protection from the elements, choose from two great Polaris® options.



**ADD ZIP WINDOW UPPER DOORS
TO STOCK HALF DOORS**

- Durable, rugged canvas stitched over a robust steel frame
- Lightweight, UV-resistant construction
- Retention straps for increased strength

- Zipper windows for increased venting options
- Mounts easily by drilling into stock doors (drill hole plugs included)

FRONT

» 2882548 • **\$1,099⁹⁹**
POLARIS GENERAL® 4 '18-19
POLARIS GENERAL® '18-19

REAR

» 2883453 • **\$2,039⁹⁹**
POLARIS GENERAL® 4 '18-19

View this Polaris GENERAL® 6 and make it your own
POLARIS.COM/GENERALtrail

**POLARIS ENGINEERED
ADVANTAGES**



COVERAGE FOR YOUR CAB

Protect yourself from the elements. The right roof shields you from the sun and driving rain.

2-SEAT ROOFS

ROOF - ALUMINUM

» 2881105 • \$539⁹⁹
POLARIS GENERAL® '16-19

PREMIUM ROOF - POLY

» 2883800 • \$709⁹⁹
POLARIS GENERAL® '16-19

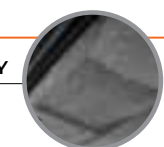

INCLUDES PREMIUM ROOF LINER

SPORT ROOF - POLY

» 2883780 • \$409⁹⁹
POLARIS GENERAL® '16-19



4-SEAT ROOFS

NEW PREMIUM ROOF - POLY

» 2883801 • \$999⁹⁹
POLARIS GENERAL® 4 '17-19

SPORT ROOF - POLY

» 2883781 • \$669⁹⁹
POLARIS GENERAL® 4 '17-19



INCLUDES PREMIUM ROOF LINER

POLARIS ENGINEERED ADVANTAGES

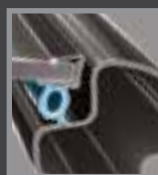

A PERFECT FIT FOR THE PERFECT SEAL

Polaris Engineered™ cab components nest perfectly into the contours of the cab frame with a 360° gasket seal.

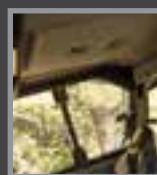

PREMIUM FEATURES & QUIETER RIDE

Roof liners provide a clean look by hiding wiring, and absorb noise for a quieter ride.



KEEP MOISTURE MOVING

Keep precipitation moving with integrated channels that direct water away.

TAKE ON THE TERRAIN

Arm your Polaris GENERAL® with Polaris Engineered™ bumpers and guards to take on any challenge. Engineered for easy, secure installation; providing added protection for lights, bodywork and suspension.

REAR BUMPERS

SPORT REAR BUMPER

» 2881095 • \$309⁹⁹
POLARIS GENERAL® 4 '17-18,
POLARIS GENERAL® '16-18



BUMPERS

A SPORT LOW PROFILE FRONT BUMPER

» 2881094 • \$339⁹⁹
POLARIS GENERAL® 4 '17-19,
POLARIS GENERAL® '16-19

B SPORT UPPER FRONT BUMPER

» 2881525 • \$339⁹⁹
POLARIS GENERAL® 4 '17-19,
POLARIS GENERAL® '16-19
Requires Sport Low Profile Front Bumper

A-ARM GUARDS

HMW A-ARM GUARDS - FRONT

» 2880274 • \$269⁹⁹
POLARIS GENERAL® 4 '17-19,
POLARIS GENERAL® '16-19

HMW A-ARM GUARDS - REAR

» 2880171 • \$269⁹⁹
POLARIS GENERAL® 4 '17-19,
POLARIS GENERAL® '16-19

ROCK SLIDERS / NERF BARS

LOW PROFILE STEEL ROCK SLIDERS

» 2881102 • \$379⁹⁹
POLARIS GENERAL® '16-19

EXTREME KICK-OUT STEEL NERF BARS

» 2-SEAT • 2881101 • \$409⁹⁹
POLARIS GENERAL® '16-19
» 4-SEAT • 2881992 • \$669⁹⁹
POLARIS GENERAL® 4 '17-19



EXPANSION ANCHOR MOUNTS
TOUGH EXPANSION ANCHOR MOUNTS DESIGNED FOR POLARIS GENERAL® ALLOW FOR QUICK INSTALL OF ROCK SLIDERS AND BUMPERS WITHOUT DAMAGING THE VEHICLE'S FRAME.

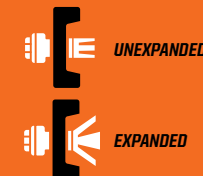

REVOLUTIONIZING THE OFF-ROAD EXPERIENCE

- TOTAL COMMAND CENTER FOR A WORLD OF CONNECTION AT YOUR FINGERTIPS
- BUILT IN GPS WITH TOPOGRAPHY MAPS TO SEE YOUR LOCATION AND PLAN YOUR RIDE
- MEDIA PLAYER W/ BUILT IN AM/FM TUNER FOR ALL YOUR FAVORITE MUSIC
- BUDDY TRACKING AND SHARE YOUR RIDE USING THE RIDE COMMAND® MOBILE APP*
- HOLD A CONVERSATION WITHOUT SHOUTING AND SEE CALLS/TEXTS**

POLARIS RIDECOMMAND®

SPRING 2019 AVAILABILITY

RIDE COMMAND® 7" DISPLAY **NEW**



- 7" High Bright Touchscreen visible in all conditions
- Displays critical vehicle information for fuel level, coolant temp and battery voltage
- Media player w/ built in AM/FM tuner
- Buddy tracking and share your ride
- Dedicated shortcut buttons for quick access to features
- Bluetooth® and USB smart phone connectivity
- Front camera support for better visibility on and off trail

» 2884002 • \$1,999⁹⁹
POLARIS GENERAL® 4 '19,
POLARIS GENERAL® '19

SPRING 2019 AVAILABILITY

RIDE COMMAND® MOUNT KIT **NEW**



- Mount Ride Command® seamlessly into the dash for perfect fit & finish
- Comes with wiring harnesses needed for Polaris GENERAL® and accessory components
- Includes front camera

» WITH RIDE COMMAND®
MTX® SOUNDBAR
» 2883803 • \$929⁹⁹
POLARIS GENERAL® 4 '19,
POLARIS GENERAL® '19

» WITHOUT RIDE COMMAND®
MTX® SOUNDBAR
» 2883804 • \$409⁹⁹
POLARIS GENERAL® 4 '19,
POLARIS GENERAL® '19

VISIT POLARIS.COM FOR FITMENT ON YOUR SPECIFIC MODEL & YEAR

*DOWNLOAD THE RIDE COMMAND® MOBILE APP



CHECK FOR FEATURE ENHANCEMENTS & UPDATES AT POLARIS.COM/RIDECOMMAND

**Requires in-helmet communication.

POLARIS ENGINEERED™ ADVANTAGES

NEW INTRODUCING POLARIS PULSE™ Electrical System



ELECTRICAL INSTALLS MADE EASY WITH PLUG & PLAY

POLARIS PULSE™ IS A REVOLUTIONARY way to provide power to your vehicle, and makes adding electrical accessories a snap. Light bars, audio or other cab accessories are easier to install.

- To install accessories, simply plug the harness into the Polaris PULSE™ hub
- No need to remove nuts and stack wire terminals like a three-post terminal setup
- By plugging in your accessories, a secure connection is guaranteed every time

Look for to identify Polaris PULSE™ ready accessories.

THE FOLLOWING ACCESSORIES EASILY PLUG INTO THE FACTORY INSTALLED POLARIS PULSE™ UNDER THE HOOD:

- MTX® Premium Sound Bar *At right*
- 8-Vent Heater & Defrost System *At right*
- Windshield Wiper & Washer System *At right*
- All RIGID® & Pro Armor® Light Bars *P. 16*

NEW POLARIS PULSE™ LED LIGHT BAR HARNESS

- Required to easily add electric components
- » 2883785 • \$114⁹⁹
POLARIS GENERAL® 4 '19,
POLARIS GENERAL® '19

CAB COMFORT



MTX® PREMIUM SOUNDBAR

- Fully-sealed, injection-molded enclosure with marine-grade components
- 8 Speakers, 100-Watt
- Bluetooth® connections
- Not compatible with Ride Command® (Need 2883803 Ride Command® MTX® Soundbar with Mount Kit)
- » 2881115 • \$869⁹⁹
POLARIS GENERAL® 4 '17-19,
POLARIS GENERAL® '16-19



8-VENT HEATER & DEFROST SYSTEM

- » 2881316 • \$1,289⁹⁹
POLARIS GENERAL® 4 '17-19,
POLARIS GENERAL® '16-19



WINDSHIELD WIPER & WASHER SYSTEM

- » 2881090 • \$739⁹⁹
POLARIS GENERAL® 4 '17-19,
POLARIS GENERAL® '16-19



CONVEX REAR VIEW MIRROR

- » 2881540 • \$124⁹⁹
POLARIS GENERAL® 4 '17-19,
POLARIS GENERAL® '16-19



MULTI-FUNCTION CAB LIGHT

- LED dome light provides white, red, green and blue lighting options
- Battery-operated, recharges when vehicle is on
- Removed to use as a flashlight in & around vehicle
- NEW**
- » 2884047 • \$134⁹⁹
POLARIS GENERAL® 4 '19,
POLARIS GENERAL® '19



- » 2879270 • \$99⁹⁹
POLARIS GENERAL® 4 '17-18,
POLARIS GENERAL® '16-18
Not compatible with 2881105 Roof



FLOOR MATS

- » 2881934 • \$169⁹⁹
POLARIS GENERAL® 4 '17-19,
POLARIS GENERAL® '16-19

POLARIS® REMOTE GARAGE DOOR OPENER BY HOMELINK®

- » 2882082 • \$209⁹⁹
POLARIS GENERAL® 4 '17-18,
POLARIS GENERAL® '16-18

ACCESSORIES

WINDSHIELDS & REAR PANELS

DOORS

ROOFS & PROTECTION

TECH, AUDIO & LIGHTING

STORAGE & COOLERS

WHEELS & TIRES

WINCHES & PLOWS

LOCK AND LOAD IT

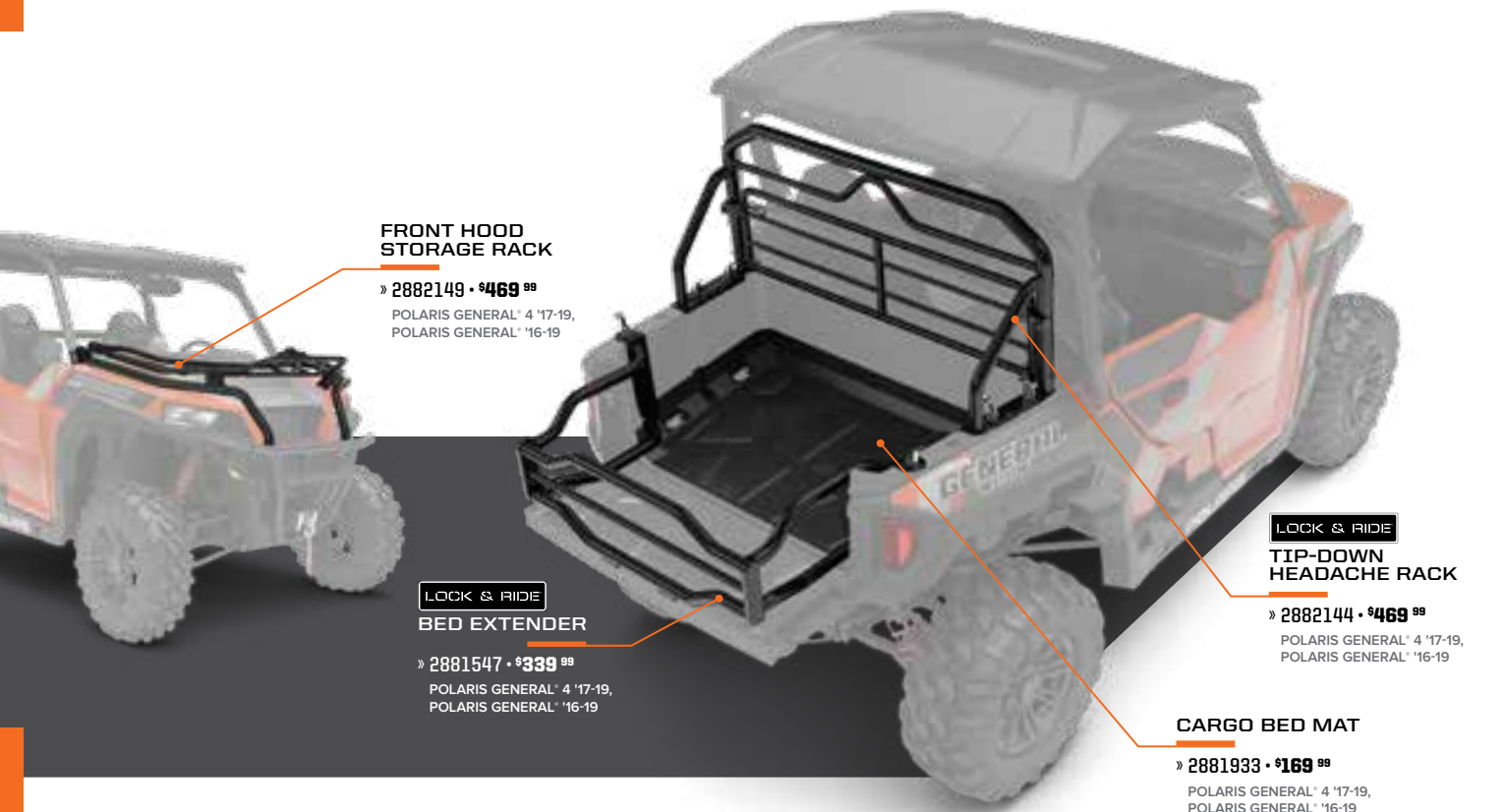

FRONT HOOD STORAGE RACK

» 2882149 • \$469⁹⁹
POLARIS GENERAL® 4 '17-19,
POLARIS GENERAL® '16-19

LOCK & RIDE BED EXTENDER

» 2881547 • \$339⁹⁹
POLARIS GENERAL® 4 '17-19,
POLARIS GENERAL® '16-19

LOCK & RIDE TIP-DOWN HEADACHE RACK

» 2882144 • \$469⁹⁹
POLARIS GENERAL® 4 '17-19,
POLARIS GENERAL® '16-19

CARGO BED MAT

» 2881933 • \$169⁹⁹
POLARIS GENERAL® 4 '17-19,
POLARIS GENERAL® '16-19

Ample storage with
multiple openings for
ease & convenience



LOCK & RIDE CARGO BOX

» 2881527 • \$409⁹⁹
POLARIS GENERAL® 4 '17-19,
POLARIS GENERAL® '16-19

LOCK & RIDE D-RINGS

» 2881545 • \$43⁹⁹
POLARIS GENERAL® 4 '17-19,
POLARIS GENERAL® '16-19

STRAP OPTIONS

P. 21

KOLPIN[®] OUTDOORS

PROTECT THE
GEAR YOU NEED.
LIVE THE LIFE
YOU LOVE.



We would like to thank our partners Browning® and Mathews® for helping to deliver a successful and safe off-road experience when out in the field.



KOLPIN STRONGHOLD[®] MOUNT

LOCK & RIDE

KOLPIN STRONGHOLD[®] AUTO-LATCH DOUBLE BOOT MOUNT

» 2883970 • \$234⁹⁹
POLARIS GENERAL® 4 '17-19,
POLARIS GENERAL® '16-19

KOLPIN STRONGHOLD[®] CASES

KOLPIN STRONGHOLD[®] GUN BOOTS

» XL TRANSPORT • 2882430 • \$129⁹⁹
POLARIS GENERAL® 4 '17-19,
POLARIS GENERAL® '16-19

» L IMPACT • 2882426 • \$83⁹⁹
POLARIS GENERAL® 4 '17-19,
POLARIS GENERAL® '16-19

KOLPIN STRONGHOLD[®] PISTOL BOOT

» 2882429 • \$69⁹⁹
POLARIS GENERAL® 4 '17-19,
POLARIS GENERAL® '16-19

KOLPIN STRONGHOLD[®] ICE ROD BOOT

» 2882428 • \$129⁹⁹
POLARIS GENERAL® 4 '17-19,
POLARIS GENERAL® '16-19

KOLPIN STRONGHOLD[®] ICE AUGER/ POP-UP BLIND BOOT

» 2882427 • \$109⁹⁹
POLARIS GENERAL® 4 '17-19,
POLARIS GENERAL® '16-19

*REQUIRES AUTO-LATCH MOUNT (2883970 OR 2884106)



LOCK & RIDE SPARE TIRE CARRIER

» 2881529 • \$269⁹⁹
POLARIS GENERAL® 4 '17-19,
POLARIS GENERAL® '16-19



BEHIND SEAT STORAGE BAG

» 2882164 • \$94⁹⁹
POLARIS GENERAL® '16-19



IN-DASH STORAGE BAG

» 2882165 • \$64⁹⁹
POLARIS GENERAL® 4 '17-19,
POLARIS GENERAL® '16-19

FIRE EXTINGUISHER HOLDER [NOT SHOWN]

» 2882158 • \$114⁹⁹
POLARIS GENERAL® 4 '17-19,
POLARIS GENERAL® '16-19
Fits most 3.25" fire extinguishers (not included)

POLARIS ENGINEERED™ ADVANTAGES



LOCK & RIDE

REVOLUTIONARY INSTALLATION

Available on all Polaris® vehicles, Lock & Ride® accessories allow for a quick reconfiguration between work and adventure. With the flip of a lever, Lock & Ride® plungers use downward pressure to expand for a secure fit.



KOLPIN RHINO GRIPS[®] IDEAL FOR BOWS & UNCASSED GUNS

LOCK & RIDE RATCHETING RHINO GRIP[®]

» 2881575 • \$90⁹⁹
POLARIS GENERAL® 4 '17-19,
POLARIS GENERAL® '16-19

LOCK & RIDE RHINO GRIP[®] PRO

» 2884107 • \$109⁹⁹
POLARIS GENERAL® 4 '17-19,
POLARIS GENERAL® '16-19

LOCK & RIDE RHINO GRIP[®] XL

» 2881574 • \$62⁹⁹
POLARIS GENERAL® 4 '17-19,
POLARIS GENERAL® '16-19

LOCK & RIDE RHINO GRIP[®] XL DOUBLE

» 2884108 • \$94⁹⁹
POLARIS GENERAL® 4 '17-19,
POLARIS GENERAL® '16-19

RHINO GRIP[®] XL REPLACEMENT RUBBER STRAPS

» 2881621 • \$7⁹⁹
POLARIS GENERAL® 4 '17-19,
POLARIS GENERAL® '16-19

RHINO GRIP[®] PRO RUBBER STRAPS

» 2884109 • \$11⁹⁹
POLARIS GENERAL® 4 '17-19,
POLARIS GENERAL® '16-19

KEEP IT ICE COLD



POLARIS NORTHSTAR® COOLERS can survive just about anything - from extreme heat to a nasty tumble off a vehicle. So when we say ice will stay cold for hours on end and anything inside will stay locked up tight, we mean it.

POLARIS NORTHSTAR® COOLER



- | | | | | |
|--|--|--|--|--|
| 99 LITER | 57 LITER | 28 LITER | 14 LITER <i>NEW</i> | 19 LITER SOFTSIDE |
| » GRAPHITE • 2883426 • \$509⁹⁹
» DESERT • 2883392 • \$509⁹⁹ | » GRAPHITE • 2883425 • \$409⁹⁹
» DESERT • 2881259 • \$409⁹⁹ | » GRAPHITE • 2883424 • \$309⁹⁹
» DESERT • 2881315 • \$309⁹⁹ | » GRAPHITE • 2883968 • \$249⁹⁹ | » GRAPHITE • 2883390 • \$209⁹⁹ |

28, 57 & 99 LITER FEATURES

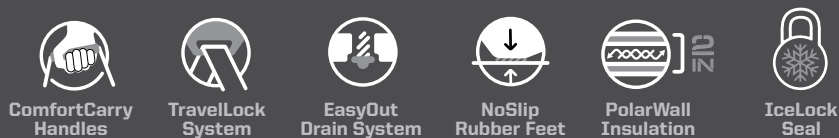

TUMBLERS

- » 887 mL • 2883394 • **\$36⁹⁹**
- » 591 mL • 2883393 • **\$30⁹⁹**

GRIZZLY TESTED. POLARIS® APPROVED.



This cooler is IGBC-approved, meaning it withstands the power expended by a typical grizzly bear if it was trying to get inside. Seriously, there are experts who know what a grizzly is capable of doing, and they certify that the Polaris Northstar® Cooler can take it.



POLARIS NORTHSTAR® COOLER ACCESSORIES



WIRE BASKET

- » 99 LITER • 2883648 • **\$59⁹⁹** *NEW*
- » 57 LITER • 2882185 • **\$43⁹⁹**
- » 28 LITER • 2882438 • **\$36⁹⁹**



DIVIDERS

- » 99 LITER • 2883468 • **\$43⁹⁹** *NEW*
COMES WITH ONE DIVIDER
 - » 2882184 • **\$59⁹⁹**
COMES WITH TWO DIVIDERS
 - » 28 LITER • 2882186 • **\$30⁹⁹**
COMES WITH ONE DIVIDER
- Divider doubles as a cutting board



99 LITER
1 way to partition



57 LITER
2 ways to partition



28 LITER
1 way to partition



SEAT CUSHION

- » 57 LITER • 2882179 • **\$114⁹⁹**
- » 28 LITER • 2882507 • **\$89⁹⁹**

COOLER WHEELS

- » 57 LITER • 2882180 • **\$124⁹⁹**

BOTTLE OPENER

- » 2882183 • **\$15⁹⁹**
ALL COOLERS



HOLDS ICE 30+ HOURS LONGER THAN YETI*

*YETI is a registered trademark of YETI COOLERS, LLC



LOOK & HIDE QUICKSTRAP

- » 2882187 • **\$59⁹⁹**
ALL COOLERS AND POLARIS
GENERAL® CARGO BOXES



NEW 3.8 cm x 4.6 m 2495 kg RATCHET STRAP

- Heavy duty webbing
- 2495 kg Maximum Load / 831 kg Working Load
- 2 Pack

- » 2884031 • **\$59⁹⁹**



NEW 5.1 cm x 6.1 m 4536 kg RATCHET STRAP

- Heavy duty webbing
- 4536 kg Maximum Load / 1497 kg Working Load
- Floating D-Rings
- Double J-Hooks

- » 2884032 • **\$43⁹⁹**

PRO ARMOR®

Each wheel and tire Pro Armor® designs for off-road vehicles performs perfectly in the intended environment for its intended use. Developed, tested, and produced in partnership so you can tackle the terrain ahead with Polaris®.

TRIPLE-BELTED SIDEWALLS

- Sidewalls are the most vulnerable puncture area of any off-road tire
- Pro Armor® makes tires with extra protection exactly where it's needed most - the sidewall

8 OR 10-PLY RATED

- Pro Armor® builds the toughest tires
- Higher ply ratings mean added protection

INNOVATION

DUAL DUROMETER LUGS (Crawler XG & Attack 2.0)

- Firm durometer rubber on base of lug for stability
- Soft durometer rubber on top of lug for sticky grip

DUAL COMPOUND TREAD (Dual-Threat)

- Firm durometer rubber on center of tread for long wear life
- Soft durometer rubber on shoulders of tread for superior grip

4,828+ km RATED

Pile on the kilometers with Pro Armor® tires. Every tire is designed and constructed with longevity in mind. With ratings of 4,828 kilometers and beyond, you are assured long life and performance.

KNOW YOUR TIRES

DIMENSIONS	TREAD DEPTH	WEIGHT	PLY RATING	SIDEWALL BELTS	LOAD RATING
28" x 9" R14 <small>TIRE HEIGHT TIRE WIDTH WHEEL DIAMETER</small>	A deeper tread means more grip in all conditions	A lighter tire makes for improved vehicle performance	Indicates tire puncture-resistance	Increase your resistance to sidewall punctures	Tires with higher load ratings can handle more weight



BACKCOUNTRY/TRAIL



PRO ARMOR® DUAL-THREAT

- Dual-compound technology and radial construction offer performance in all terrains
- Softer durometer rubber on outer edge for overall superior grip and feel
- Harder durometer rubber in the middle for increased traction during acceleration and longer tread life

		TREAD DEPTH	TIRE WEIGHT	PLY RATING	SIDEWALL BELTS	LOAD RATING
14"	26" x 9" R14 5416340 • *219 ⁹⁹	FRONT	12 kg	10	3	413 kg
14"	26" x 11" R14 5416341 • *229 ⁹⁹	REAR	14 kg			503 kg
14"	29" x 9" R14 5416342 • *269 ⁹⁹	FRONT	14 kg			503 kg
14"	29" x 11" R14 5416343 • *279 ⁹⁹	REAR	16 kg			599 kg

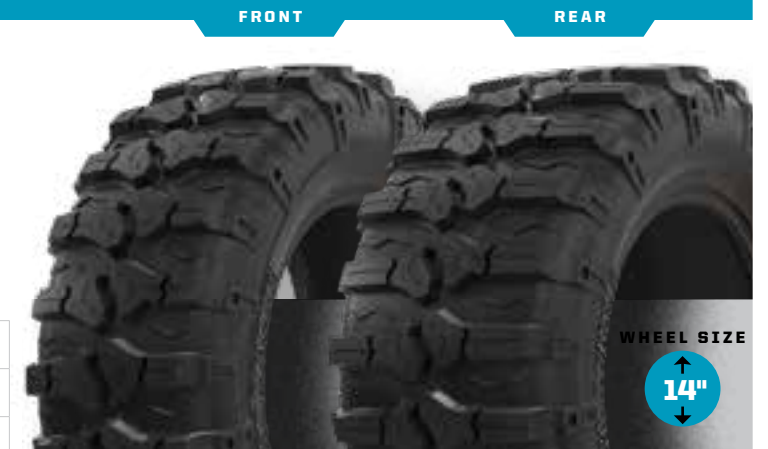

DUAL-COMPOUND = MORE GRIP + LONGER LIFE

Firmer Durometer Rubber = Longer Life | Softer Durometer Rubber = More Grip



PRO ARMOR® ATTACK 2.0

- Engineered for excellent hard-pack performance
- Dual-compound technology and radial construction offer performance in all terrains
- Tight thread pattern for a quieter ride

		TREAD DEPTH	TIRE WEIGHT	PLY RATING	SIDEWALL BELTS	LOAD RATING	
15"	28" x 10" R15 5416344 • *269 ⁹⁹	FRONT/REAR	25mm	15 kg	10	3	503 kg



ATTACK 2.0 VS. ATTACK

- **Tighter Tread Pattern** = Better traction in hard pack
- **Dual-Durometer Lug** = Increased grip & traction in rough terrain, smoother ride in all terrain
- **10-Ply Rated** = increased durability
- **Larger Size Offering in 28"** = more ground clearance & trail traction



PRO ARMOR® ATTACK

- The best all-purpose tire for all-season traction in any terrain
- Unique, full-face tread design
- Harder durometer lugs promote extended wear, increasing tire life
- Wider spaced lugs provide more grip in softer terrain

		TREAD DEPTH	TIRE WEIGHT	PLY RATING	SIDEWALL BELTS	LOAD RATING
14"	26" x 9" R14 5415613 • *189 ⁹⁹	FRONT	13 kg	8	3	413 kg
14"	26" x 11" R14 5415614 • *209 ⁹⁹	REAR	15 kg			599 kg



ACCESSORIES

WINDSHIELDS & REAR PANELS

DOORS

ROOFS & PROTECTION

TECH, AUDIO & LIGHTING

STORAGE & COOLERS

WHEELS & TIRES

WINCHES & PLOWS



View this Polaris GENERAL® & make it your own
[POLARIS.COM/GENERALtrail](https://www.polaris.com/GENERALtrail)

MUD



FRONT

REAR

PRO ARMOR® DAGGER

- From the trails to the pits, this tire gets you through it all
- Deep, self-cleaning lug and wide tire design for exceptional mud pit performance
- Rounded profile and full lug pattern for on-trail comfort

			TREAD DEPTH	TIRE WEIGHT	PLY RATING	SIDEWALL BELTS	LOAD RATING
14"	27" x 9" R14 5415617 • *279 ⁹⁹	FRONT	38mm	15 kg	8	3	503 kg
14"	27" x 11" R14 5415618 • *299 ⁹⁹	REAR		18 kg			531 kg



WHEEL SIZE

14"

ROCK



FRONT / REAR

PRO ARMOR® CRAWLER XR

- Wanna race? This tire grips it all from the trail to the rocks
- Square block profile for even surface contact
- A tougher durometer than the XG to take on the toughest the trail has to offer

			TREAD DEPTH	TIRE WEIGHT	PLY RATING	SIDEWALL BELTS	LOAD RATING
14"	28" x 10" R14 5415536 • *259 ⁹⁹	FRONT/REAR	16mm	15 kg	8	3	517 kg



WHEEL SIZE

14"

XR

SINGLE DUROMETER

- Smaller lug height and single durometer gives this high-speed tire added rigidity and lateral stability when cornering
- Unique lug design excels in hard-packed, fast terrain



WHAT CRAWLER ARE YOU?



FRONT / REAR

PRO ARMOR® CRAWLER XG

- Big or small, these tires crawl them all
- A soft, sticky compound makes this tire ideal for both rock crawling and desert running
- 8-ply, triple-belted ballistic sidewalls resist punctures

			TREAD DEPTH	TIRE WEIGHT	PLY RATING	SIDEWALL BELTS	LOAD RATING
15"	28" x 10" R15 5416346 • *269 ⁹⁹	FRONT/REAR	20mm	15 kg	8	3	503 kg



WHEEL SIZE

15"

XG

DUAL-DUROMETER

- Taller lug height and dual-durometer construction
- Perfect balance between high-speed performance, durability and flex in order to grip slick rock



UTILITY

FRONT / REAR

FRONT / REAR

FRONT / REAR



WHEEL SIZE

14"

12"



PRO ARMOR HARVESTER™

- All-around work horse with tread life of 5,000 miles
- Tread pattern designed to withstand anything from the farm yard, to the pastures to the trail
- With 10-Ply it can carry the load day-in and day-out

14"	28" x 10" R14 • FRONT/REAR • 5416347 • *269 ⁹⁹
14"	27" x 10" R14 • FRONT/REAR • 5415965 • *249 ⁹⁹
12"	26" x 8" R12 • FRONT • 5416396 • *229 ⁹⁹
12"	26" x 10" R12 • REAR • 5415966 • *249 ⁹⁹

			TREAD DEPTH	WEIGHT	PLY RATING	SIDEWALL BELTS	LOAD RATING
26R12	FRONT	16mm	11 kg	10	3	3	388 kg
	REAR						615 kg
27R14	FRONT/REAR	15 kg	10	3	599 kg		
28R14	FRONT/REAR	15 kg			630 kg		



WHEEL SIZE

14"

12"



PRO ARMOR PRESERVE™

- 5,000-mile tread life
- Turf-friendly for areas where low-impact tire tread is needed
- Rounded profile and special tread pattern to limit footprint

14"	27" x 10" R14 • FRONT/REAR • 5416348 • *249 ⁹⁹
12"	26" x 8" R12 • FRONT • 5416403 • *229 ⁹⁹
12"	26" x 10" R12 • REAR • 5416402 • *249 ⁹⁹

			TREAD DEPTH	WEIGHT	PLY RATING	SIDEWALL BELTS	LOAD RATING
26R12	FRONT	16mm	11 kg	10	3	3	388 kg
	REAR						599 kg
27R14	FRONT/REAR	13 kg			599 kg		



WHEEL SIZE

12"



PRO ARMOR XD-K

- 26" Aramid fiber-belted tire to tackle any terrain
- Unique full-face tread design
- Harder durometer lugs promotes for extended wear increasing tire life

12"	26" x 9" R12 • FRONT • 5415756 • *247 ¹⁹
12"	26" x 11" R12 • REAR • 5415757 • *260 ⁹⁹

			TREAD DEPTH	WEIGHT	PLY RATING	SIDEWALL BELTS	LOAD RATING
FRONT	31.7mm	13 kg	10	3/1 Aramid	3	3	388 kg
							REAR

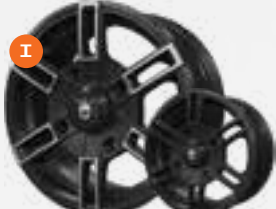
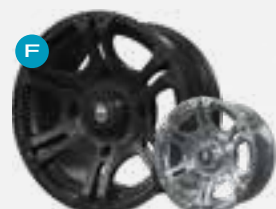
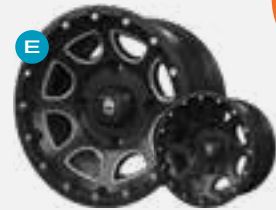
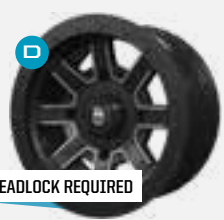
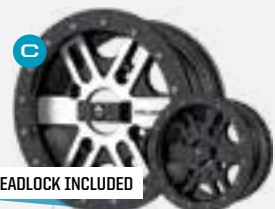

14"

15"

BEADLOCK REQUIRED

BEADLOCK INCLUDED

A AMPLIFY

FRONT WEIGHT: 5.9 kg | **LOAD RATING:** 408 kg | **OFFSET:** -9
REAR WEIGHT: 6.4 kg | **LOAD RATING:** 590 kg | **OFFSET:** +4
ACCENT: FRONT 14" x 7" - 1522956-266 **\$189⁹⁹**
 REAR 14" x 8" - 1522957-266 **\$209⁹⁹**
MATTE BLACK: FRONT 14" x 7" - 1522956-458 **\$169⁹⁹**
 REAR 14" x 8" - 1522957-458 **\$179⁹⁹**

B BUCKLE

FRONT WEIGHT: 5.8 kg | **LOAD RATING:** 408 kg | **OFFSET:** +4
REAR WEIGHT: 6.1 kg | **LOAD RATING:** 590 kg | **OFFSET:** -9
ACCENT: FRONT 14" x 7" - 1522544-266 **\$189⁹⁹**
 REAR 14" x 8" - 1522545-266 **\$209⁹⁹**
MATTE BLACK: FRONT 14" x 7" - 1522544-458 **\$169⁹⁹**
 REAR 14" x 8" - 1522545-458 **\$179⁹⁹**

C COMBAT (BEADLOCK RINGS INCLUDED)

WEIGHT: 7.3 kg | **LOAD RATING:** 729 kg | **OFFSET:** +38
ACCENT: 14" x 7" - 1523283 **\$259⁹⁹**
MATTE BLACK: 14" x 7" - 1523284 **\$269⁹⁹**

D REBLR (REQUIRES BEADLOCK RINGS)

FRONT WEIGHT: 5.9 kg | **LOAD RATING:** 408 kg | **OFFSET:** +4
REAR WEIGHT: 6.6 kg | **LOAD RATING:** 590 kg | **OFFSET:** -9
ACCENT: FRONT 14" x 7" - 1522238-458 **\$279⁹⁹**
 REAR 14" x 8" - 1522239-458 **\$279⁹⁹**

E SHACKLE

FRONT WEIGHT: 5.9 kg | **LOAD RATING:** 408 kg | **OFFSET:** +4
REAR WEIGHT: 6.4 kg | **LOAD RATING:** 590 kg | **OFFSET:** -9
ACCENT: FRONT 14" x 7" - 1522546-266 **\$189⁹⁹**
 REAR 14" x 8" - 1522547-266 **\$189⁹⁹**
MATTE BLACK: FRONT 14" x 7" - 1522546-458 **\$169⁹⁹**
 REAR 14" x 8" - 1522547-458 **\$169⁹⁹**

F SIXR

FRONT WEIGHT: 4.8 kg | **LOAD RATING:** 408 kg | **OFFSET:** +4
REAR WEIGHT: 5.7 kg | **LOAD RATING:** 590 kg | **OFFSET:** -9
MATTE BLACK: FRONT 14" x 7" - 1521507-521 **\$149⁹⁹**
 REAR 14" x 8" - 1521508-521 **\$169⁹⁹**
LUSTER: FRONT 14" x 7" - 1521507-410 **\$189⁹⁹**
 REAR 14" x 8" - 1521508-410 **\$199⁹⁹**

G CYCLONE

WEIGHT: 7.8 kg | **LOAD RATING:** 590 kg | **OFFSET:** +4
ACCENT: 15" x 7" - 1523184-266 **\$179⁹⁹**
MATTE BLACK: 15" x 7" - 1523184-458 **\$149⁹⁹**

H HALO (BEADLOCK RINGS INCLUDED)

WEIGHT: 7.7 kg | **LOAD RATING:** 726 kg | **OFFSET:** +38
ACCENT: 15" x 7" - 1523282 **\$299⁹⁹**
MATTE BLACK: 15" x 7" - 1523266 **\$269⁹⁹**

I WYDE

WEIGHT: 6.1 kg | **LOAD RATING:** 590 kg | **OFFSET:** +55
ACCENT: 15" x 7" - 1522550-266 **\$269⁹⁹**
MATTE BLACK: 15" x 7" - 1522550-458 **\$249⁹⁹**

J FLARE

WEIGHT: 8.1 kg | **LOAD RATING:** 590 kg | **OFFSET:** +4
ACCENT: 15" x 7" - 1523102-266 **\$179⁹⁹**
MATTE BLACK: 15" x 7" - 1523102-458 **\$149⁹⁹**

LUG NUTS REQUIRED

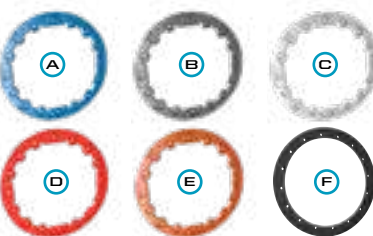

14" FORGED BEADLOCK RINGS

Only used on REBLR

	PART #	MSRP
A	1522244-619	\$114 ⁹⁹
B	1522244-266	\$114 ⁹⁹
C	1522244-133	\$114 ⁹⁹
D	1522244-293	\$114 ⁹⁹
E	1522244-589	\$114 ⁹⁹
F	1523146-458	\$74 ⁹⁹

Sold individually

14" SETS

WHEEL & TIRE SETS

TIRES	ATTACK 26" 4828 km	DAGGER 27" 4828 km	DUAL-THREAT 26" 4828 km	DUAL-THREAT 29" 4828 km	PRESERVE 27" 8047 km	PRO ARMOR HARVESTER 27" 8047 km	PRO ARMOR HARVESTER 28" 8047 km	CRAWLER XR 28" 4828 km
AMPLIFY Accent	2882390 \$1,489 ⁹⁹	2882392 \$1,799 ⁹⁹	2883138 \$1,669 ⁹⁹	2883146 \$1,859 ⁹⁹	2883208 \$1,599 ⁹⁹	2882388 \$1,739 ⁹⁹	2883225 \$1,859 ⁹⁹	2882394 \$1,739 ⁹⁹
AMPLIFY Matte Black	2882391 \$1,359 ⁹⁹	2882393 \$1,669 ⁹⁹	2883139 \$1,539 ⁹⁹	2883147 \$1,739 ⁹⁹	2883209 \$1,599 ⁹⁹	2882389 \$1,599 ⁹⁹	2883226 \$1,739 ⁹⁹	2882395 \$1,599 ⁹⁹
BUCKLE Accent	2881335 \$1,599 ⁹⁹	2881337 \$1,999 ⁹⁹	2883140 \$1,699 ⁹⁹	2883148 \$1,859 ⁹⁹	2883203 \$1,739 ⁹⁹	2882383 \$1,739 ⁹⁹	2883220 \$1,859 ⁹⁹	2881343 \$1,739 ⁹⁹
BUCKLE Matte Black	2881336 \$1,479 ⁹⁹	2881338 \$1,799 ⁹⁹	2883141 \$1,539 ⁹⁹	2883149 \$1,739 ⁹⁹	2883204 \$1,599 ⁹⁹	2882384 \$1,599 ⁹⁹	2883221 \$1,739 ⁹⁹	2881344 \$1,599 ⁹⁹
COMBAT Accent BEADLOCKS PRE-MOUNTED			2883217 \$2,059 ⁹⁹	2883219 \$2,269 ⁹⁹				2883213 \$2,139 ⁹⁹
COMBAT Matte Black BEADLOCKS PRE-MOUNTED			2883216 \$1,939 ⁹⁹	2883218 \$2,139 ⁹⁹				2883212 \$1,999 ⁹⁹
REBLR Matte Black BEADLOCKS SOLD SEPARATELY	2881381 \$1,669 ⁹⁹	2881383 \$1,999 ⁹⁹						2881386 \$1,999 ⁹⁹
SHACKLE Accent	2881347 \$1,599 ⁹⁹	2881349 \$1,999 ⁹⁹	2883142 \$1,699 ⁹⁹	2883150 \$1,859 ⁹⁹	2883205 \$1,739 ⁹⁹	2882385 \$1,739 ⁹⁹	2883222 \$1,859 ⁹⁹	2881355 \$1,739 ⁹⁹
SHACKLE Matte Black	2881348 \$1,479 ⁹⁹	2881350 \$1,799 ⁹⁹	2883143 \$1,539 ⁹⁹	2883151 \$1,739 ⁹⁹	2883206 \$1,599 ⁹⁹	2882386 \$1,599 ⁹⁹	2883223 \$1,739 ⁹⁹	2881356 \$1,599 ⁹⁹
SIXR Luster	2881359 \$1,599 ⁹⁹	2881362 \$1,999 ⁹⁹						2881371 \$1,739 ⁹⁹
SIXR Matte Black	2881360 \$1,479 ⁹⁹	2881363 \$1,799 ⁹⁹	2883144 \$1,539 ⁹⁹	2883152 \$1,739 ⁹⁹	2883207 \$1,599 ⁹⁹	2882387 \$1,599 ⁹⁹	2883224 \$1,739 ⁹⁹	2881372 \$1,599 ⁹⁹

EVERY 14" SET FITS ALL POLARIS GENERAL® MODELS
 POLARIS GENERAL® 4 '17-19,
 POLARIS GENERAL® '16-19

LUG NUTS REQUIRED

15" SETS

TIRES	ATTACK 2.0 28" 4828 km	CRAWLER XG 28" 4828 km
CYCLONE Accent	2883160 \$1,799 ⁹⁹	2883188 \$1,799 ⁹⁹
CYCLONE Matte Black	2883159 \$1,669 ⁹⁹	2883187 \$1,669 ⁹⁹
FLARE Accent	2883158 \$1,799 ⁹⁹	2883186 \$1,799 ⁹⁹
FLARE Matte Black	2883157 \$1,669 ⁹⁹	2883185 \$1,669 ⁹⁹
HALO Accent BEADLOCKS PRE-MOUNTED	2883162 \$2,169 ⁹⁹	2883190 \$2,169 ⁹⁹
HALO Matte Black BEADLOCKS PRE-MOUNTED	2883161 \$2,059 ⁹⁹	2883189 \$2,059 ⁹⁹
WYDE Accent	2883156 \$1,799 ⁹⁹	2883184 \$1,799 ⁹⁹
WYDE Matte Black	2883155 \$1,669 ⁹⁹	2883183 \$1,669 ⁹⁹

EVERY 15" SET FITS ALL POLARIS GENERAL® MODELS
 POLARIS GENERAL® 4 '17-19,
 POLARIS GENERAL® '16-19

12MM x 1.5 SPLINED LUG NUTS

LUG NUTS REQUIRED

16 SPLINED LUG NUTS WITH WRENCH ADAPTER	2879332 \$54 ⁹⁹
4 SPLINED LUG NUTS WITHOUT WRENCH	2879331 \$18 ⁹⁹
12MM x 1.5 SPLINED LUG WRENCH	2204966 \$12 ⁹⁹

REPLACEMENT CAPS

LUSTER	AMPLIFY, BUCKLE, COMBAT, CYCLONE, FLARE, HALO, REBLR, SHACKLE, SIXR	1521509-410 \$15 ⁹⁹
MATTE BLACK	AMPLIFY, BUCKLE, COMBAT, CYCLONE, FLARE, HALO, REBLR, SHACKLE, SIXR	1521509-521 \$15 ⁹⁹
PRO ARMOR		
LUSTER	AMPLIFY, BUCKLE, COMBAT, CYCLONE, FLARE, HALO, REBLR, SHACKLE, SIXR	5453209-410 \$15 ⁹⁹
MATTE BLACK	AMPLIFY, BUCKLE, COMBAT, CYCLONE, FLARE, HALO, REBLR, SHACKLE, SIXR	5453209-458 \$15 ⁹⁹
MATTE BLACK	WYDE	1523063-458 \$13 ⁹⁹

TRACKS



PROSPECTOR PRO® TRACK SYSTEM

- Polaris® exclusive optimized hub geometry minimizes feedback and eases steering effort
- Flexible lug design provides the highest level of deep snow performance by lifting up in deep snow as opposed to digging down
- Lightweight design with slight weight reduction over Camoplast® kit provides for better flotation, eases steering effort, and provides better vehicle control

PROSPECTOR PRO® TRACK MOUNTS

- Install this track system mounting hardware in place of tires and wheels. Tracks sold separately

» 2880649 • **\$649⁹⁹**
 POLARIS GENERAL® 4 '17-19,
 POLARIS GENERAL® '16-19

PROSPECTOR PRO® TRACK

» 2880758 • **\$6,449⁹⁹**
 POLARIS GENERAL® 4 '17-19,
 POLARIS GENERAL® '16-19

If using Glacier™ Pro Plow System with tracks, Track Plow Extension is required (2880267)

CHOOSE THE RIGHT WINCH

PRO PRO HEAVY DUTY SERIES

INDUSTRY 1ST TECHNOLOGY

RAPID ROPE RECOVERY 5X FASTER

RAPID ROPE RECOVERY

1. Set Winch Dial to FREE SPOOL (N) to attach Winch Hook
2. Set Winch Dial to PULL (L) for Winch Mode
3. Set Winch Dial to ROPE RECOVERY (H) for 5x Faster Rope Recovery

INTEGRATED WIRING INCLUDED

SEALED PERMANENT MAGNET MOTOR

PREMIUM SYNTHETIC ROPE

- Lightweight & Easy to Handle
- Superior Flexibility
- Greater Strength than Steel Cable
- 15 m Long

WIRELESS REMOTE

15 m range with unique code for interference-free operation

AUTO STOP TECHNOLOGY

FAIRLEAD COLLAR HOOK



Winch stops when fairlead detects collar

Auto Stop Technology stops winch at end of pull to prevent driveline stress and plow overlifting

I-HD HEAVY DUTY SERIES

CUT STEEL GEARS & SEALED DRIVETRAIN

HOOK WITH STRAP

3 STEPS FOR ADDING A WINCH:				
1 FIND YOUR MACHINE	2 CHOOSE BETWEEN POLARIS® PRO HD OR POLARIS® HD WINCH		3 ADD CABLES	
	PRO PRO HEAVY DUTY SERIES	I-HD HEAVY DUTY SERIES		
MODEL	2041 kg	2041 kg	1588 kg	REQUIRED BATTERY CONNECTION CABLES
POLARIS GENERAL® 4 '19 POLARIS GENERAL® '19	NEW 2883861 \$1,139 ⁹⁹	NEW 2883860 \$809 ⁹⁹		
POLARIS GENERAL® 4 '17-18 POLARIS GENERAL® '16-18	2882239 \$1,099 ⁹⁹	2882477 \$999 ⁹⁹	2882476 \$669 ⁹⁹	2882373 \$54 ⁹⁹ <small>REQUIRED FOR POLARIS GENERAL® '16-18 BASE MODELS ONLY</small>
RAPID ROPE RECOVERY	STANDARD			
AUTO STOP TECHNOLOGY	STANDARD	OPTION		
WINCH LINE	SYNTHETIC	STEEL CABLE		
FAIRLEAD	ALUMINUM	STEEL ROLLER		
CONTROL	WIRELESS & DASH SWITCH	DASH SWITCH		

UPGRADE YOUR POLARIS® HD WINCH WITH THESE ACCESSORIES

POLARIS® WIRELESS WINCH REMOTE

- Allows for remote operation of Polaris® HD winch
- Up to 15 m range with LED indicator
- Direct plug and play operation
- » 2881287 • \$179⁹⁹

SYNTHETIC WINCH ROPE

- 2041 kg WINCH SERIES
- » 2879187 • \$179⁹⁹
- POLARIS GENERAL® '16-19
- 1588 kg WINCH SERIES
- » 2878888 • \$104⁹⁹
- POLARIS GENERAL® '16-19

AUTO STOP TECHNOLOGY WINCH UPGRADE

- Machined from billet aluminum and weighs less than common steel fairleads
- Installs easily in place of stock fairlead
- Requires synthetic winch rope (not included) (not compatible with steel cable)
- » 2041 kg • 2881288 • \$134⁹⁹
- » 1588 kg • 2881289 • \$134⁹⁹
- POLARIS GENERAL® 4 '17-19,
- POLARIS GENERAL® '16-19

DASH SWITCH HARNESS

- » 2882373 • \$54⁹⁹
- POLARIS GENERAL® 4 '17-19,
- POLARIS GENERAL® '16-19
- REQUIRED ON ABOVE MODELS TO ADD WINCH

WINCH WIRING KIT

- » 2-SEAT • 2879388
- \$44⁹⁹
- POLARIS GENERAL® '16-19
- REQUIRED ON ABOVE MODELS TO ADD WINCH
- » 4-SEAT • 2879685
- \$74⁹⁹
- POLARIS GENERAL® 4 '17-19
- REQUIRED ON ABOVE MODELS TO ADD WINCH

THERE'S A REASON THESE ARE THE BEST WINCHES ON THE MARKET.

Polaris® winches are fully sealed to keep out water, dust and other debris.



TESTED 1,200+ PULLS AT MAX LOAD, IT WORKS WHEN YOU NEED IT TO

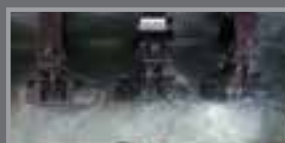

SEALED MOTOR & HEAVY DUTY GEARS OPERATE FULLY SUBMERGED UNDERWATER



BUILT TO WITHSTAND -29° C TEMPERATURES



MILITARY TESTED & APPROVED

PUSH FOR MORE

GLACIER® PRO HD GIVES YOU

» OR Blades

» Choice of poly or steel

» Manual angle system standard

GLACIER® PRO HD PLOW SYSTEM



MAKE QUICK WORK OF SMALLER JOBS

Move snow with the robust and capable Glacier® HD plow system, and discover why a major snowfall can be the highlight of your week. With a robust frame, beefy poly and steel blade options, convenient Lock & Ride® mounting and dismantling and amazing value, Glacier® HD is a great choice in the dead of winter.

BLADE MATERIAL

Durable poly and steel blades are designed to push more. Choose a steel blade for longevity and increased rigidity or a lightweight non-stick, poly blade that's easier on plowing surfaces.



168 cm POLY BLADE BEST FOR CORROSION RESISTANCE



183 cm STEEL BLADE BEST FOR BIG JOBS YEAR AFTER YEAR

	STEP 1 SELECT A MOUNT	STEP 2 SELECT A FRAME	STEP 3 SELECT A LIFT METHOD	STEP 4 SELECT A BLADE	STEP 5 SELECT ACCESSORIES
MODELS	MOUNT	FRAME	WINCH	BLADES	ACCESSORIES
POLARIS GENERAL® 4 '17-19,	2881763 \$439 ⁹⁹	2880260 \$609 ⁹⁹	Polaris® PRO HD 2041 kg Winch 2883861 \$1,139 ⁹⁹ <small>POLARIS GENERAL® 4 '19, POLARIS GENERAL® '19</small>	183 cm Steel 2880270 \$609 ⁹⁹	183 cm Blade Snow Deflector 2858541 \$89 ⁹⁹ 183 cm HD Wear Bar 2879875 \$139 ⁹⁹ 183 cm Wear Bar 2204976 \$74 ⁹⁹ 168 cm Blade Snow Deflector 2879866 \$114 ⁹⁹ 168 cm HD Wear Bar 2879868 \$134 ⁹⁹ 168 cm Wear Bar 2879867 \$74 ⁹⁹
POLARIS GENERAL® '16-19			Polaris® PRO HD 2041 kg Winch 2882239 \$1,099 ⁹⁹ <small>POLARIS GENERAL® 4 '17-18, POLARIS GENERAL® '16-18</small>	168 cm Poly 2880269 \$539 ⁹⁹ 168 cm Steel 2880268 \$469 ⁹⁹	Plow Marker 2872726 \$43 ⁹⁹ Skid Shoe 2205071 \$36 ⁹⁹ Shear Pin 2205527 \$10 ⁹⁹ Extension for Tracks 2880267 \$339 ⁹⁹

GLACIER® HD GIVES YOU

» Blades

» Choice of poly or steel

» Manual angle system standard

GLACIER® HD PLOW SYSTEM

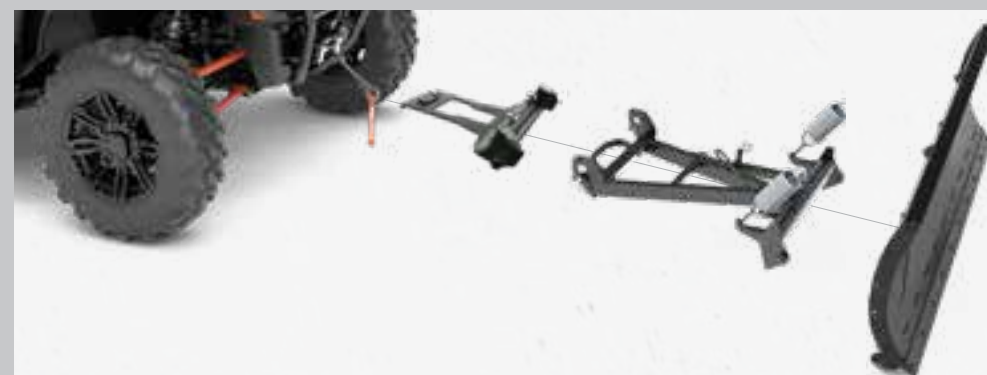

168 cm POLY BLADE BEST FOR CORROSION RESISTANCE



168 cm STEEL BLADE BEST FOR BIG JOBS YEAR AFTER YEAR

	STEP 1 SELECT A MOUNT	STEP 2 SELECT A FRAME	STEP 3 SELECT A LIFT METHOD	STEP 4 SELECT A BLADE	STEP 5 SELECT ACCESSORIES
MODELS	MOUNT	FRAME	WINCHES	BLADES	ACCESSORIES
POLARIS GENERAL® 4 '17-19,	2883256 \$309 ⁹⁹	2882927 \$609 ⁹⁹	Polaris® PRO HD 2041 kg Winch 2883860 \$809 ⁹⁹ <small>POLARIS GENERAL® 4 '19, POLARIS GENERAL® '19</small>	168 cm Poly 2880269 \$539 ⁹⁹	168 cm Blade Snow Deflector 2879866 \$114 ⁹⁹ 168 cm HD Wear Bar 2879868 \$134 ⁹⁹ 168 cm Wear Bar 2879867 \$74 ⁹⁹
POLARIS GENERAL® '16-19			Polaris® HD 2041 kg Winch 2882477 \$999 ⁹⁹ <small>POLARIS GENERAL® 4 '17-18, POLARIS GENERAL® '16-18</small>	168 cm Steel 2880268 \$469 ⁹⁹	Plow Marker 2872726 \$43 ⁹⁹ Skid Shoe 2205071 \$36 ⁹⁹ Shear Pin 2205527 \$10 ⁹⁹

CREATE YOUR GLACIER® HD PLOW SYSTEM IN 5 STEPS

ACCESSORIES

WINDSHIELDS & REAR PANELS

DOORS

ROOFS & PROTECTION

TECH, AUDIO & LIGHTING

STORAGE & COOLERS

WHEELS & TIRES

WINCHES & PLOWS

ENGINEERED TO MAXIMIZE THE LIFE OF YOUR RIDE

All Polaris® fluids—from AGL to Demand Drive Fluid—are developed for your vehicle. Trust the only fluids perfectly engineered for your needs.



SPECIFIC NEEDS, SPECIFIC OILS

Polaris® invests millions in engine development, and part of that investment is making sure its lubricants—critical to engine performance—are the right formula for your specific engine. The amount of testing data and engineering resources used in developing Polaris® lubricants would overwhelm an aftermarket company. Therefore, the aftermarket must produce an oil to an industry-wide standard that must account for a variety of operating parameters.

PS-4 is designed specifically for Polaris® 4-cycle engines and has high film strength and wear protection under extreme loads and temperatures. Exclusive anti-wear additives protect engine parts with extra rust and corrosion protection.



Everything needed to change your oil! The correct filter & amount of oil for your vehicle.



PS-4 OIL CHANGE KIT (OIL & FILTER)		PS-4 [EXTREME DUTY] OIL CHANGE KIT (OIL & FILTER)	
PART NUMBER	VEHICLE FITMENT	PART NUMBER	
2202166	RANGER®/RZR®/SPORTSMAN® 570, TWIN 600, TWIN 700, TWIN 800	2879004	
2879323	RANGER®, POLARIS GENERAL®, RZR® 900/1000, RS1	2879324	
2877473	RANGER®/SPORTSMAN® 300-500, SPORTSMAN®/SCRAMBLER® 500/850/1000	2878924	
2881696	RZR® TURBO	2881697	



PS-4 FULL-SYNTHETIC OIL

PS-4 is optimal for ambient operating temperatures of -40° C to 38° C

- » .95 L • 2876244
- » 3.8 L • 2876245
- » 60.6 L • 2876247



PS-4 EXTREME-DUTY FULL-SYNTHETIC OIL

PS-4 Extreme Duty is optimal for ambient operating temperatures of -18° C to 54° C

- » .95 L • 2878920
- » 3.8 L • 2878919
- » 60.6 L • 2879003



ORV MAINTENANCE KIT

This convenient kit includes everything you need, in the correct fluid volumes, to properly maintain your drive train, and keep your vehicle in top operating condition.

- Includes: 1.4 L AGL, .95 L Angle Drive Fluid, 1 pint Demand Drive Fluid, 1-3 oz. tube of All-Season Grease

» 2880425

PROVEN PROTECTION

Powersports grade, full-synthetic base oils and proprietary additive systems outperform leading automotive and aftermarket engine oils in 75 hour severe duty engine testing.

PS-4 vs. AUTO OIL

60% MORE ROD END BEARING WEAR PROTECTION WITH PS-4



WORN & GROOVED

+ 40% LESS CYLINDER WEAR WITH PS-4

+ 30% LESS GRAFAL WEAR* WITH PS-4

*The purpose of the grafal coating is primarily to decrease friction and protect the piston from wear.



PS-4 RACE PROVEN PERFORMANCE

"The Baja 1000 is probably the toughest race in the world! In the brutal Baja desert there are so many things that can ruin your race it is great to know that Polaris Engineered Lubricants will never let us down.

We trust in the Polaris products like the PS-4 motor oil to protect our machines vitals, they are a critical part of a winning formula."

**BILL SCHUELER
CREW CHIEF JAGGED X**

MAINTENANCE FLUIDS



OIL
Maximum protection for your 4-cycle engine. Exclusive anti-wear additives protect your engine and extend the life of engine components.
Change every 100 hours, 6 months or 800 km.



AGL
Extreme pressure additives protect gears, drive chain, and bearings from scoring and wear. Unlike typical gear case oils, AGL's unique viscosity range allows instant flow and film protection in extreme cold or high heat environments.
Change every 100 hours, 12 months or 1600 km.

- » .95 L • 2878068
- » 3.8 L • 2878069
- » 9.5 L • 2878070
- » 208 L • 2879594



U-JOINT GREASE

A heavy-duty lubricant formulated with molybdenum disulfide to accept the high shock applications of Polaris' ATV shaft drive universal joints.

Add every 50 hours, 3 months or 800 km.

- » 89 mL • 2871515
- » 414 mL • 2871551



DOT 4 BRAKE FLUID

A high-quality brake fluid designed for use in Polaris' hydraulic brakes. Superior high-temp characteristics plus anti-corrosive additives extend the life of brake system components and provide consistent, positive braking.

Change every 200 hours, 3200 km or every 2 years.

- » 355 mL • 2872189



ANTI-FREEZE

Organic acid technologies to prevent corrosion on metal components, eliminate scaling, and maximize cooling system performance.

Change every 60 months.

- » .95 L • 2880514
- » 3.8 L • 2880513
- » 208 L • 2880512



DEMAND DRIVE FLUID

Provides positive 4WD engagement in extreme cold or high heat conditions. Unique friction additives protect internal components under heavy loads and promote positive engagement.

Change every 100 hours or yearly.

- » .95 L • 2877922
- » 9.5 L • 2877923



PREMIUM GAS SHOCK OIL

- » .95 L • 2870995
 - » 9.5 L • 2872279
- FOX® REBUILDABLE SHOCKS



10WT GAS SHOCK OIL

- » .95 L • 2874124
- WALKER EVANS® REBUILDABLE SHOCKS



CHAIN LUBRICANT

- » 473 mL AEROSOL 2872348



ALL-SEASON GREASE TUBE

- » 89 mL • 2871322
- » 414 mL • 2871423



ANGLE DRIVE FLUID

- » .95 L • 2876160
 - » 9.5 L • 2872276
- SPORTSMAN®, RANGER®, RZR® ANGLE DRIVE GEAR CASE SYSTEMS



CARBON CLEAN

- Prevents ethanol corrosion, stabilizes fuel, and cleans fuel injectors, piston ring lands, intake systems, and combustion chambers. Helps maintain peak HP and improves fuel economy.
- » 355 mL • 2881413



ADVANCED FUEL TREATMENT

- Prevents ethanol corrosion and stabilizes fuel for up to 2 years. Dual-antioxidant formula protects against gum and varnish for easy starting.
- » 355 mL • 2881416
- » 9.5 L • 2881417

LUBRICANT ACCESSORIES



GREASE GUN KIT

- » 2871312 • \$44⁹⁹
- FITS 2871322 ALL-SEASON AND 2871322 U-JOINT 88.7 mL



2D BATTERY-OPERATED SIPHON PUMP

- Liquid transfer pumps 5-6 quarts/min suctioning power
- Use with gas, water, oil, and other non-corrosive liquids
- » 2830513 • \$20⁹⁹



FLEX SPOUT

- Convenient easy pour flex spout fits all Polaris® quart, gallon, and 9.5 L bottles
- » 2871285 • \$3⁹⁹



PUMP

- Attaches to 3.8- or 9.5-liter bottle for easy, no-drip dispensing
- » 2870465 • \$9⁹⁹

TIRE SEALANT

HOW IT WORKS

Tire sealant remains liquefied inside your tire until a leak develops in the tire or wheel.



Once a leak occurs, the tire sealant rushes out of the tire and quickly creates a permanent solid plug.

The plug maintains the pressure of the tire so you can continue your ride.

PREMIUM TIRE SEALANT

- Instantly seals and repairs rim, bead leaks, and punctures up to 0.64 cm on standard tires, and 1.9 cm on heavy ply tires
- Helps maintain air pressure for the life of the tire
- Helps seal the tire bead against the wheel
- 100% water soluble for easy cleanup
- Will not rust, corrode, or pit wheels
- Creates permanent repair
- Remains fluid and effective in temperatures down to -43° C
- Easily installed through existing tire valve stem with valve core removed

- » 946 mL • 2830484 • \$22⁹⁹
- » 3.8 LITER • 2830485 • \$79⁹⁹
- » 19 LITER • 2830486 • \$335⁹⁹

- » 19 LITER PUMP • 2830487 • \$149⁹⁹
- » 208 LITER • 2830489
- » 1041 LITER • 2830488



24 X 7 COVERAGE | BE PREPARED FOR ANYTHING

NOTHING CAN STOP YOU.

COVERAGE WHEN YOU NEED IT.

FIX ON THE GO | TEMPORARY COVERAGE

CV BOOT REPAIR KIT*

- A quick trail side fix to increase trail time.
- The flexible and durable boot material expands over a cone tool for CV boot repairs, without disassembling CV axles.
- Universal fit - works as a temporary fix for most powersports axles.
- All components fit inside the cone, and a cover is provided for compact durable storage.
- Easily fits in a cargo box, attached to the roll cage, in the glovebox, or many other storage locations.



Items shown are contained inside cone

UTV CV BOOT REPAIR KIT

Kit includes the following items:

- (1) Expandable XL CV Boot
- (1) Reusable Cone Tool
- (2) CV Boot Clamps
- (1) Tube of Silicone Lube
- (1) Grease Packet
- (1) Cone Cover

- » 2830526 • \$35⁹⁹

UTV TRAIL BOOT ONLY

- » 2830527 • \$17⁹⁹

ATV

- » CV REPAIR KIT 2830528 • \$31⁹⁹
- » TRAIL BOOT ONLY 2830529 • \$17⁹⁹

SEE HOW THE CV BOOT REPAIR KIT WORKS AT POLARIS.COM/MAINTENANCE-VIDEOS

HOW TO INSTALL

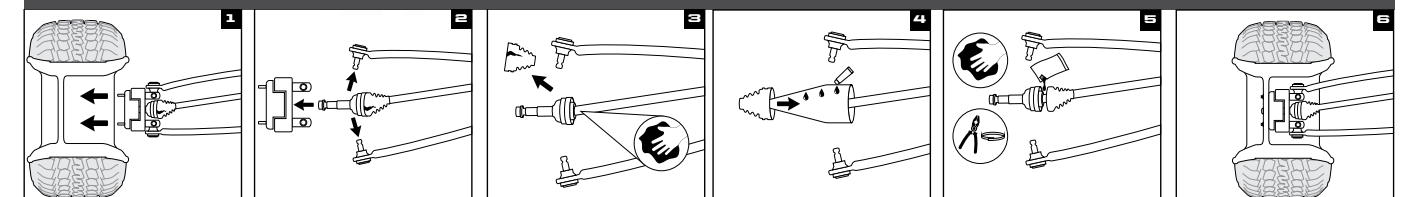

1. Remove wheel and axle nut
2. Remove brake caliper, hub, tie rod, & upper & lower ball joints
3. Remove old boot & clean joint
4. Spread silicone lube on entire cone tool. Slide boot over cone tool, large end first. See package for outer boot instructions.
5. Empty the bag of grease into the CV joint/boot, clean sealing points & install clamps
6. Reassemble tie rod, ball joints, brake caliper, axle nut, tire & wheel

Refer to your owner's manual for further instructions and torque specifications.

*Designed for temporary CV boot repair. Purchase the OEM CV Boot for a permanent repair.

FOR THE LIFE OF YOUR RIDE

THE KEY TO KEEPING YOUR POLARIS® OFF-ROAD VEHICLE PERFORMING as well as the day you brought it home is proper maintenance. Items like belts, filters, and batteries represent only a few of these critical items engineered specifically by Polaris®.

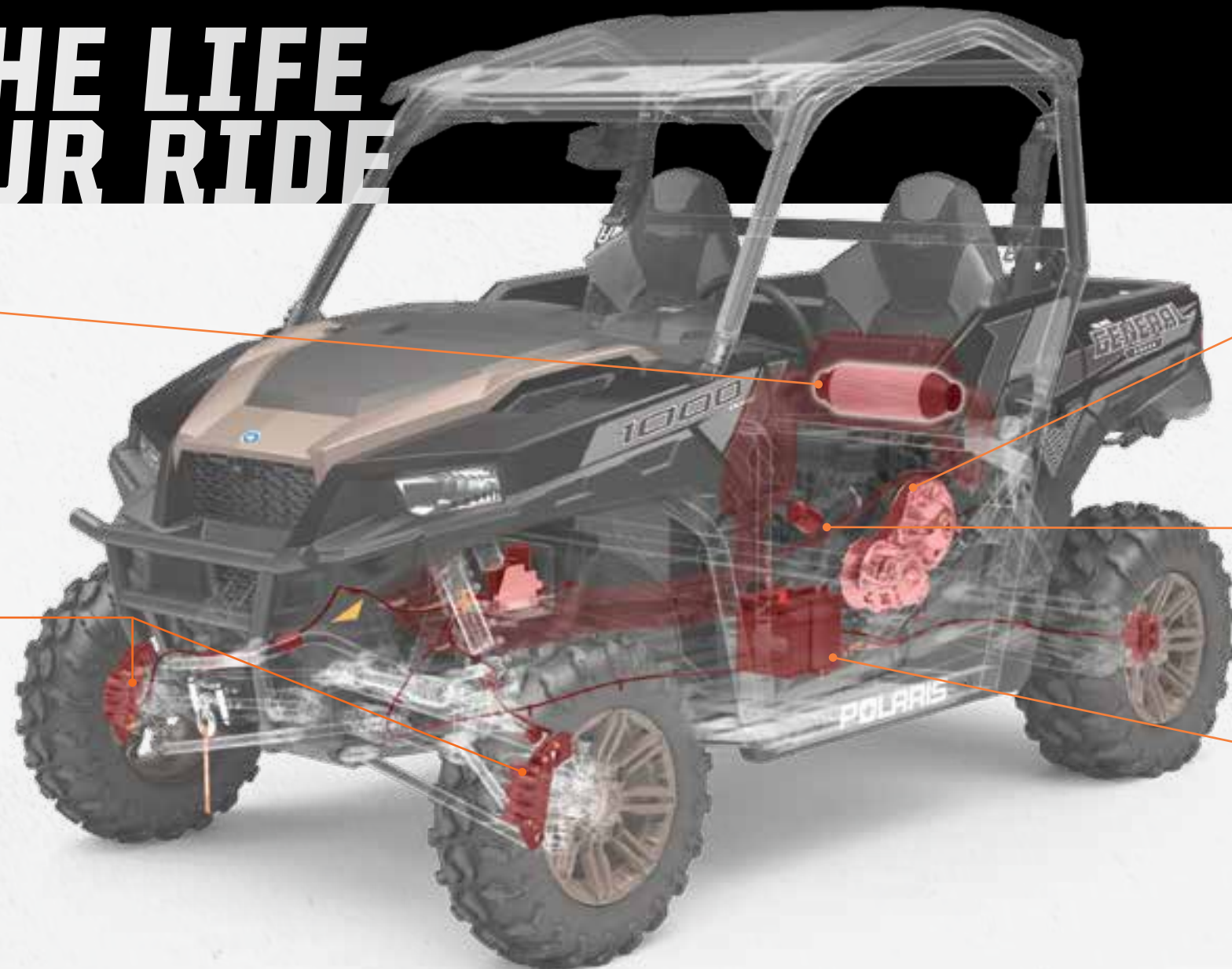

AIR FILTERS

Critical to engine performance and reliability. A clogged air filter can restrict air flow to the engine leading to reduced engine performance. Dirt and debris ingestion can damage the engine leading to reduced engine life or catastrophic failure. Polaris® recommends changing the vehicle's air filter at the specified intervals outlined in the owner's manual, which may be shorter if your vehicle is subject to severe conditions.

BRAKE PADS

Check your brakes if you are close to the recommended service interval, hear grinding when applying the brakes, your vehicle is taking longer to stop or if you have to apply more pressure to your pedal to engage the brakes. Check the brake discs for signs of cracks, excessive corrosion or warping.

If the brake pads are contaminated with oils or grease (petroleum products), brake pads have to be discarded and replaced.

Discs need to be cleaned with brake cleaner or alcohol based cleaner only.

DRIVE BELTS

Polaris Engineered™ belts deliver unmatched performance for your off-road vehicle. Developed and tested on all our engines for all environments and conditions. Check your belt for delamination, hour glassing and glazing.

OIL FILTERS

Change oil filters with every oil change to provide the best protection for your engine. Superior engine protection keeps your engine operating at peak performance. Be sure to follow the suggested service intervals for oil/oil filter changes.

BATTERIES

Never leave a battery unattended during the storage season. To ensure your battery maintains its level of charge when unused for extended periods of time or during freezing weather, the battery should be connected to a BatteryMINDER™. Be sure to check for corrosion from the terminals to the ends of the cables.

MAINTENANCE TIP

BREAK-IN PERIOD

The break-in period for your new Polaris GENERAL™ is the first 25 hours of operation, or the time it takes to use the first two tanks of fuel. No single action on your part is as important as a proper break-in period. Careful treatment of a new engine will result in more efficient performance and longer life for the engine. Perform the listed procedures carefully.

NOTICE: Excessive heat build-up during the first three hours of operation will damage close-fitted engine parts. Do not operate at full throttle or high speeds for extended periods during the first three hours of use.

SEE OUR LATEST MAINTENANCE TIPS AT [POLARIS.COM/MAINTENANCE-VIDEOS](https://www.polaris.com/maintenance-videos)



MAINTENANCE SCHEDULE

25 HRS/400 km

BREAK-IN MAINTENANCE

ENGINE OIL:
CHANGE

GENERAL LUBRICATION:
ALL FITTINGS, PIVOTS, CABLES, ETC.

AIR FILTER:
INSPECT & CLEAN
REPLACE AS NEEDED

EXHAUST SYSTEM:
INSPECT & CLEAN
INSPECT FOR LEAKAGE OR CARBON BUILD UP AT JOINTS
INSPECT & CLEAN SCREEN TYPE SPARK ARRESTOR

50 HRS/800 km

6 MONTHS

EXHAUST SYSTEM:
INSPECT & CLEAN
INSPECT FOR LEAKAGE OR CARBON BUILD UP AT JOINTS
INSPECT & CLEAN SCREEN TYPE SPARK ARRESTOR

GENERAL LUBRICATION:
ALL FITTINGS, PIVOTS, CABLES, ETC.

DRIVE BELT:
INSPECT & ADJUST
REPLACE AS NEEDED

100 HRS/1600 km

12 MONTHS

ENGINE OIL:
CHANGE

DRIVE BELT:
INSPECT & ADJUST
REPLACE AS NEEDED

TRANSMISSION FLUID:
CHANGE

EXHAUST SYSTEM:
INSPECT & CLEAN
INSPECT FOR LEAKAGE OR CARBON BUILD UP AT JOINTS
INSPECT & CLEAN SCREEN TYPE SPARK ARRESTOR

150 HRS/2400 km

18 MONTHS

ENGINE OIL:
CHANGE

BATTERY:
TEST, CLEAN, & CHECK FLUID LEVEL
REPLACE AS NEEDED

DRIVE BELT:
INSPECT & ADJUST
REPLACE AS NEEDED

TIRES:
INSPECT CONDITION & PRESSURE

EXHAUST SYSTEM:
INSPECT & CLEAN
INSPECT FOR LEAKAGE OR CARBON BUILD UP AT JOINTS
INSPECT & CLEAN SCREEN TYPE SPARK ARRESTOR

200 HRS/3200 km

24 MONTHS

ENGINE OIL:
CHANGE

BRAKE PADS & FLUID:
INSPECT & CLEAN
REPLACE AS NEEDED

SPARK PLUGS:
INSPECT
REPLACE AS NEEDED

EXHAUST SYSTEM:
INSPECT & CLEAN
INSPECT FOR LEAKAGE OR CARBON BUILD UP AT JOINTS
INSPECT & CLEAN SCREEN TYPE SPARK ARRESTOR

350 HRS/4020 km

30 MONTHS

ENGINE OIL:
CHANGE

BATTERY:
TEST, CLEAN, & CHECK FLUID LEVEL
REPLACE AS NEEDED

DRIVE BELT:
INSPECT & ADJUST
REPLACE AS NEEDED

GENERAL LUBRICATION:
ALL FITTINGS, PIVOTS, CABLES, ETC.

EXHAUST SYSTEM:
INSPECT & CLEAN
INSPECT FOR LEAKAGE OR CARBON BUILD UP AT JOINTS
INSPECT & CLEAN SCREEN TYPE SPARK ARRESTOR

500 HRS/8045 km

36 MONTHS

ENGINE OIL:
CHANGE

AIR FILTER:
INSPECT, CLEAN
REPLACE AS NEEDED

COOLANT:
CHECK LEVEL
REPLACE EVERY 2 YEARS

GEARCASES:
CHECK OIL LEVEL

EXHAUST SYSTEM:
INSPECT & CLEAN
INSPECT FOR LEAKAGE OR CARBON BUILD UP AT JOINTS
INSPECT & CLEAN SCREEN TYPE SPARK ARRESTOR

CHECK YOUR OWNER'S MANUAL FOR ADDITIONAL RECOMMENDED SERVICE ITEMS AND VEHICLE-SPECIFIC TIMING

SERVICE PARTS

Polaris Engineered™ service parts deliver unmatched performance and fit for your off-road vehicle.

All service parts are developed and tested for your vehicle. Half shafts, bushings, bearings, decals, side panels, electrical components, and clutching components are the same parts that are manufactured on the factory lines for each specific vehicle. This ensures it doesn't merely fit your vehicle - it outperforms your expectations!

SHOP FOR SERVICE PARTS ONLINE OR VISIT YOUR POLARIS® DEALER.

OVER
100,000
PARTS
AVAILABLE!



CHECK OUT OUR PARTS FINDER ON POLARIS.COM
FOR EASY PARTS LOOK-UP, PARTS IDENTIFICATION, VIEWS OF ASSEMBLIES & MORE!



STEP 1

Visit Polaris.com/GENERAL
Click "Parts & Service" tab
Click "Service Parts"



STEP 2

Enter **vehicle year/model** or shop by **part number**



STEP 3

Clearly see what parts are required and **order**

Assembly
DRIVE TRAIN, FRONT HALF SHAFT - W/SPACER/BUSHING/STABILIZER (101676)

W/SPACER/BUSHING/STABILIZER POLARIS GENERAL 1000 EPS (2016) (11)

Zoom In Zoom Out

ARI PartStream

© 2017 Polaris Industries Inc. 701676

No.	Part #	Description	Price	Qty	Act
1	100646	ASH-HALF SHAFT FRONT	\$296.99	2	ADD
2	323900	ASH OUTER JOINT (FR 4800)	\$119.99	1	ADD
3	323942	KIT BUSH/LINING (AT/FR 4800)	\$44.99	2	ADD
4	323901	SHFT (FR 4810)	\$40.99	1	ADD
5	323907	ASH INNER JOINT	\$114.99	1	ADD
6	323948	CIRCLIP-1.62X1.47X.030	\$2.99	1	ADD
7	323947	CIRCLIP-1.62X1.47X.030	\$2.99	2	ADD
8	323944	DRIPSHIELD (FR 4800)	\$11.75	2	ADD



POWERFUL, PORTABLE, DURABLE.
 Portable, quiet power great for remote locations. Tested to be tough, these generators are an excellent addition to any trip.



POLARIS® FLEX JUMPSTARTER

- 12,000 mAh capacity. Two 5V/2.1A USB outputs, 200-lumen flashlight, and a digital battery life monitor. Includes storage case, smart jumper cables, car charger, wall charger, and user guide.
- 1-year limited warranty.
- Jumpstart any engine up to 6.4L. The Polaris® Flex Jumpstarter is small enough to be stored in your glovebox and holds its charge so you can count on it when it's needed.

» 2830495 • **\$143⁹⁹**

WHICH GENERATOR FITS YOUR NEEDS?

- 1** Add up the running watts of everything you might power at the same time.
- 2** Pick the device with the highest running watts and add its starting watts to the previous total.
- 3** Select a generator with a slightly higher wattage.

	Startup Wattage	Running Wattage
140 cm LCD TV	0	150
CROCK POT	0	200
RADIO	0	50-200
LAPTOP	0	200-250
625W MICROWAVE	0	625
FRIDGE OR FREEZER	700	700
COFFEE MAKER	1300	800
SUMP PUMP: 1/3 HP	1300	800
BLENDER	1000	1000
ELECTRIC GRIDDLE	0	1500
18 cm CIRCULAR SAW	1700	1400
AIR CONDITIONER	1500	1500

POLARIS POWER® INVERTER GENERATORS



P1000i

1000 WATT PORTABLE / QUIET

- Dual handles and only 16.5 kg
- Connect two units together for even more output
- Quieter than casual conversation (54db @ 25%)
- Up to 10 hours on 1 tank of gas

» P13GDGANA • **\$659⁹⁹**

P2000i

2000 WATT VERSATILE / LIGHTWEIGHT

- Dual handles and only 24 kg
- Connect two units together for even more output
- Quieter than casual conversation (54db @ 25%)
- Up to 10 hours on 1 tank of gas

» P13GDGBNA • **\$959⁹⁹**

P3000iE

3000 WATT ROBUST / ELECTRIC START

- Locking 360 degree pivoting wheels
- Easy electric start for minimal effort
- Quieter than casual conversation (56db @ 25%)
- Up to 21.5 hours on 13 L of gas

» P13GDGCNA • **\$1,899⁹⁹**

GENERATOR ACCESSORIES



POLARIS POWER® COLD WEATHER KIT

- Ensure smooth running of your Polaris® Generator in sub-zero temperatures
- Prevents ice blockage in the crankcase breather tube, which may lead to operational issues including oil leakage
- Installation required, no need to disconnect for warm weather operation
- Exclusively designed for use with Polaris® P1000i & P2000i inverter generators

» 2881433 • **\$119⁹⁹**



POLARIS POWER® CABLE KIT

- Use a parallel cable kit to easily connect two Polaris Power® generators together to increase the total power available to a load

» 3410281 • **\$169⁹⁹**



POLARIS POWER® TIE-DOWN LEADS

- Secure your Polaris Power® Generator by inserting the Lock & Ride® Tie Down Leads into the handle and running a strap across to tie down the generator
- Secures Lock & Ride® accepting gear
- Safely provides a point for 2.5 cm wide tie-down strap

» 2880959 • **\$16⁹⁹**



POLARIS POWER® GENERATOR OIL

- Corrosion inhibitors protect against rust and oxidation during long-term storage

» .95 L • 2879383



POLARIS POWER® GENERATOR STORAGE COVERS

- Keep your generator looking like new with a strong, durable cover that is resistant to mold, mildew, tears, and abrasions

» 1000 WATT COVER • 2686441
\$34⁹⁹

» 2000 WATT COVER • 2686442
\$39⁹⁹

» 3000 WATT COVER • 2686443
\$44⁹⁹

BatteryMINDER®

ENSURE YOUR RIDE IS READY WHEN YOU ARE!

- Add years of capacity, power and range to new and older batteries, regardless of type or brand
- Never over or under charged in any temperature
- Leave your vehicle connected for months and return to fully charged and conditioned batteries
- Recover older-weak batteries that would normally need to be replaced
- Charge and maintain extra-backup batteries as well as those in your vehicle
- Automatic turn-on, sleeps while keeping your batteries at full-charge
- Easy Push-Button selector to change battery type or time



	BatteryMINDER® 2012 AGM 2 AMP	BatteryMINDER® 1510 1.5 AMP	BatteryMINDER® 1.5 AMP CONVERTIBLE
PRICE	\$119 ⁹⁹	\$77 ⁹⁹	\$89 ⁹⁹
PART NUMBER	2830438	2830404	2830511
VOLTAGE	12	12	12
CHARGING CURRENT	2 AMP	1.5 AMP	1.5 AMP
OVERCHARGE PROTECTION	Yes	Yes	Yes
BATTERIES MAINTAINED AT ONE TIME	6	4	4
WARRANTY	5 Years	10 Years	5 Years
BATTERY COMPATIBILITY	12 Volt Sealed AGM Lead-Acid	12 Volt flooded (filler cap) and sealed maintenance free batteries	12 Volt flooded (filler cap) and sealed maintenance free batteries
COMES WITH	• Non-fused battery clip cord set with Quick Connector	• Ambient temperature sensor (installed) • 12ft. power cord • Battery clip cord set with Quick Connector • Optional Permanent Mounting Tab	• Auto-Temp compensation sensor (installed) • Optional permanent mounting brackets & screws • Battery clips (fully-insulated, aircraft grade, 15A replaceable fuse) • Ring terminal assembly with 15A replaceable fuse
KEY FEATURES	Designed for high performance specialty AGM sealed batteries	Easy to use, economical	Convertible on-vehicle or bench top use

LIFT IT SECURELY LIFT IT SAFELY



POLARIS® VEHICLE LIFT

- Get fast, easy access to the underside of your vehicle
- Manual and pneumatic operation available
- Raises vehicle up to 81 cm to make repairs and maintenance faster and easier

» 544 kg • 2830424 • \$839⁹⁹

LIFT ATTACHMENTS

- Add the appropriate attachment to use your lift for all your off-road vehicles

» ATV/POLARIS ACE® • 2830427 • \$199⁹⁹
» SNOWMOBILE • 2830426 • \$199⁹⁹



POLARIS® X3 CREEPER

- Three positions: flat, 45-degree angle or seated work stool
- Helps you perform any repair with ease
- Stay dry and warm away from cold, wet cement floors
- Easily stores away when not in use





» BLACK • 2830429 • \$179⁹⁹

BATTERY MAINTENANCE TIPS

Extend your battery life with a BatteryMINDER® and these tips.

1. Store batteries in a cool, dry location.
2. Check that the battery connections are tight. Cables should not be able to be rotated or shifted by hand.
3. If your battery has a drain tube, make sure it is free of clogs.
4. Clean your battery - use a soft brush to scrub the top of the battery. Use baking soda to remove grease.
5. Connect a BatteryMINDER® after using your vehicle even if the vehicle is in regular use.

BatteryMINDER® ACCESSORIES

 <p>BatteryMINDER® VPP-12:12/24 VOLT VEHICLE POWER PLUG</p> <ul style="list-style-type: none"> • Allows easy connection to vehicle's battery through lighter or 12/24V power port with replaceable 15 amp fuse. <p>» 2830518 • \$12⁹⁹</p>	 <p>BatteryMINDER® 3.7 m EXTENSION CABLE</p> <ul style="list-style-type: none"> • Made with heavy-duty 16 gauge black zip cord featuring automotive SAE bullet connectors <p>» 2830410 • \$15⁹⁹</p>	 <p>BatteryMINDER® MULTI-BATTERY SPLITTER</p> <ul style="list-style-type: none"> • A simple, safe, and affordable way to connect two batteries simultaneously for easy battery maintenance • Includes a set of ring terminals <p>» 2830409 • \$29⁹⁹</p>	 <p>BatteryMINDER® RING TERMINAL KIT</p> <ul style="list-style-type: none"> • Features 61 cm long 18-gauge wire • Plug has standard .8 cm negative and .95 cm positive terminals • Replaceable 15 amp in-line fuse for circuit protection • SAE quick connector and cap <p>» 2830437 • \$11⁹⁹</p>	 <p>BatteryMINDER® EZ CONNECT</p> <ul style="list-style-type: none"> • Allows for quick and easy connecting and disconnecting of your BatteryMINDER® • Includes a set of ring terminals <p>» 2830411 • \$39⁹⁹</p>
--	---	--	---	--

SHOP ACCESSORIES

 <p>POLARIS® MAGNETIC PARTS TRAY</p> <p>» SILVER • 2830432 • \$14⁹⁹</p>	 <p>POLARIS® 8.4 cm TELESCOPIC MAGNET</p> <p>» BLACK • 2830435 • \$5⁹⁹</p>	 <p>POLARIS® 30.5 cm HI-TORQUE RATCHETING DRIVER</p> <p>» BLACK / BLUE • 2830434 • \$23⁹⁹</p>	 <p>POLARIS® LED POCKET FLASHLIGHT</p> <p>» BLACK • 2830436 • \$31⁹⁹</p>
--	---	--	---

KEEP IT CLEAN



CLEAN YOUR VEHICLE

PRE-TREAT

MUD SHIELD® PRE-TREATMENT

- Inhibits the adhesion of dirt, mud, and snow, making cleaning your vehicle faster and easier.

» 473 mL AEROSOL • 2830229 • **\$13⁹⁹**

NEVER RUST SPRAY®

- Synthetic formula highly resistant to water protects against rust and corrosion while lubricating metal surfaces.

» 473 mL AEROSOL • 2830230 • **\$14⁹⁹**

CLEAN

XP WASH®

- Foaming, highly-concentrated wash easily removes the most stubborn and intense dirt build-up.

» 946 mL • 2830225 • **\$14⁹⁹**

XP SPRAY WASH®

- Effortless biodegradable, high-performance wash ideal for removing dirt, oils and carbon—simply spray on, spray off and go.

» 946 mL • 2830224 • **\$18⁹⁹**

ALL-PURPOSE CLEANER

- Professional grade, non-streak, foam formula cuts through grease, dirt and film leaving an invisible, dirt-resistant barrier for long-lasting results.

» 473 mL • 2830227 • **\$13⁹⁹**

GLASS CLEANER

- Heavy-duty foam non-streak formula cuts through grease, dirt, dried bugs and film leaving a crystal clear dirt-resistant barrier for long-lasting results.

» 473 mL • 2830445 • **\$5⁹⁹**

SHINE

POLARIS® POLISH

- Easy protection and shine—spray on, wipe off, and go. For ideal use on painted and plastic surfaces. Contains carnauba wax.

» 335 mL • 2830228 • **\$11⁹⁹**

INSTANT SHINE & DETAILER

- Spray and wipe formula—cleans, polishes, and protects plastic and painted surfaces.

» 473 mL • 2830226 • **\$12⁹⁹**

CLEAN YOUR SHOP

TOWELS

POLARIS® SHOP TOWELS

» 200 CT WITH DISPENSER 2830402 • **\$26⁹⁹**

» 200 CT REFILL • 2830403 • **\$18⁹⁹**

» 64 CT REFILL • 2830440 • **\$5⁹⁹**



POLARIS® HEAVY-DUTY SCRUBBER WIPES

» 90 CT • 2830441 • **\$29⁹⁹**



PROFESSIONAL GRADE CLEANERS

VEHICLE

VEHICLE & EQUIPMENT WASH

- Concentrated professional grade formula powers through vehicle buildup, dirt and grease with a spot-free rinse. Treat up to 32 gals. Biodegradable product.

» 3.8 L • 2830417 • **\$19⁹⁹**

» 19 L • 2830422 • **\$69⁹⁹**

SHOP

ALL-PURPOSE CLEANER PLUS

- Professional-grade formula removes built-up stains from shop floors, work benches, and other hard surfaces. VOC-free, environmentally-friendly, and biodegradable.

» 3.8 L • 2830414 • **\$19⁹⁹**

» 19 L • 2830416 • **\$69⁹⁹**

HD CLEANER & DEGREASER

- Professional-grade, biodegradable, high-foaming formula dissolves and removes tough stains and soils.

» 3.8 L • 2830418 • **\$23⁹⁹**

» 19 L • 2830420 • **\$95⁹⁹**

BRING IT EVERYWHERE

TRAILERING



RAMP PRO BY CALIBER®

- Designed for ATVs and UTVs up to 127 cm wide
- Integrated grip glides for ultimate traction
- Folding sides for easy transportation & storing

» 132 cm x 229 cm • 2883005 • **\$519⁹⁹**



ALUMINUM ARCHED LOADING RAMPS

- » 193 cm x 30.5 cm • 907 kg • 2875384 **\$279⁹⁹**
- » 224 cm x 30.5 cm • 1361 kg • 2875386 **\$459⁹⁹**



LIGHTWEIGHT TRI-FOLD RAMPS

- Ramp folds up for transport
- Capacity for up to 680.7 kg
- Safety straps included

» 183 cm x 130 cm • 2875385 • **\$309⁹⁹**

» 208 cm x 130 cm • 2875860 • **\$369⁹⁹**



FOLDING ALUMINUM ARCHED RAMPS

- Ramp folds up for transport
- Capacity up to 1361 kg
- Safety straps included

» 224 cm x 30.5 cm • 2875387 **\$379⁹⁹**

HITCHES

3:1 HITCHES

VERSATILE 3 IN 1 FUNCTIONALITY

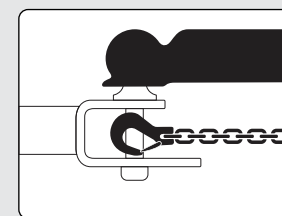

BALL

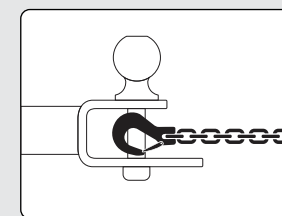

HOOK

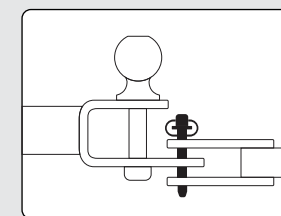

PIN

- Ball, pin and hook design
- Durable steel construction
- Rust resistant, black powdercoated finish
- Removable ball
- Heavy Duty 5/8" pin and clip



NEW HITCH WITH 2" BALL

» 2" x 2" RECEIVER 2830522 • **\$47⁹⁹**

» 1 1/2" x 1 1/4" RECEIVER 2830523 • **\$47⁹⁹**



NEW 1 7/8" BALL

- 1 7/8" replacement ball for hitch
- Designed to work with 3:1 Hitch

» 2830524 • **\$11⁹⁹**



RECEIVER HITCH

» 2" RECEIVER TONGUE 2875320 • **\$59⁹⁹**

» FRONT HITCH RECEIVER 2878846 • **\$169⁹⁹**



TRAILER BALL 3/4" SHANK

» 1 7/8" BALL • 2877602 • **\$18⁹⁹**

» 2" BALL • 2877603 • **\$18⁹⁹**

STRAPS & ROPES

NEW RECOVERY STRAP

- 5 cm x 9.1 m (8165 kg)
- Comes with carry bag

» 2884033 • **\$74⁹⁹**



NEW RATCHET STRAP

- 3.8 cm x 4.6 m straps, 2 Pack
- Heavy duty webbing
- 2495 kg maximum load, 831 kg working load

» 2884031 • **\$59⁹⁹**



NEW RATCHET STRAP

- 5 cm x 6.1 m Ratchet Straps
- Heavy duty webbing, floating D-rings, double J-hooks
- 4536 kg maximum load, 1497 kg working load

» 2884032 • **\$43⁹⁹**



SHOCK STRAPS

- 3.8 cm 1361 kg breaking strength
- Keeps tension on tie-down straps to secure load, 2 Pack

» 3.8 cm x 4.6 m • 2883296 • **\$109⁹⁹**

» 3.8 cm x 2.1 m • 2883295 • **\$94⁹⁹**



COVERS



TRAILERABLE COVER BY POLARIS®

» 2-SEAT • 2881841 • **\$469⁹⁹**

POLARIS GENERAL® '16-'19

» 4-SEAT • 2881787 • **\$539⁹⁹**

POLARIS GENERAL® '16-'19



POLARIS® SxS CAMO FIELD COVER

» 2882160 • **\$169⁹⁹**

POLARIS GENERAL® '16-'18, POLARIS GENERAL® '16-'18

**KINGPIN DIRT
509 GOGGLE**

- Quick change lens & triple layer foam
- Anti-fog & anti scratch

» ONE SIZE • \$74⁹⁹
2868671 • LIME
2868668 • ORANGE

**ORV RIDING
JERSEY**

» S-3XL • \$39⁹⁹
2868711 • LIME
2867941 • PINK
2867942 • RED



COOL

SOFTSHELL JACKET

- Lined with 280 grams of fleece for warmth
- Removable hood
- Armpit zips for venting

» MEN'S
2869919 • BLUE/ORANGE
2869918 • BLACK
» WOMEN'S
2869921 • CORAL
2869920 • BLACK



WARM

**FIND YOUR
PERFECT HELMET!**

RIDE SAFE - OUR HELMETS ARE
DOT/ECE CERTIFIED



**509° ALTITUDE
CARBON HELMET**

- Durable, ultra lightweight, Carbon Fiber
- Full carbon fiber shell
- 1100 grams

» S-4XL • \$519⁹⁹
2867814 • MATTE BLACK
2867815 • GLOSS BLACK



509° ALTITUDE HELMET

- Stylish, Lightweight with 509 Fit and Finish
- Thermoplastic poly alloy out shell
- 1260 grams

» S-4XL • \$299⁹⁹
2868539 • LIME
2867820 • BLUE
2867818 • ORANGE
2867819 • RED
2867817 • GRAY



TENACITY HELMET

- All the style and protection in our most affordable helmet
- Injection molded plastic
- 1450 grams

» XS-3XL • \$144⁹⁹
2868624 • PINK GLOSS
2868620 • BLACK/GRAY
2868622 • BLUE GLOSS
2868619 • BLACK MATTE
2868623 • RED GLOSS
2868621 • LIME GLOSS

PROTECT YOUR HANDS

OFF-ROAD RIDING GLOVES

- As seen in images at left

» S-3XL • \$32⁹⁹
2867937 • PINK
2867933 • GRAY
2868712 • BLUE/LIME
2867936 • RED
2867935 • ORANGE
2867934 • BLUE

BE PREPARED FOR ANYTHING NATURE

THROWS AT YOU

COOLING SHIRTS

- 100% Poly, chemical-free patented fabric from CoolCore®
- Moisture wicking to keep you dry and cool
- UPF 45+

» S-3XL • \$59⁹⁹
» MEN'S
2868753 • GRAY
» WOMEN'S
2868755 • GRAY/PINK



COOL

NEW

RAIN SUIT

- Lightweight
- Waterproof
- Packs small
- Removable hood
- YKK® zippers

» JACKET • 2869527
S-3XL • \$144⁹⁹
» PANT • 2869528
S-3XL • \$109⁹⁹



DRY

**STAY WARM
AND CHARGE
YOUR PHONE**

NEW

HEATED VEST

- Three heat settings for changing weather
- Down-proof material
- Removable hood
- Powered by a small rechargeable battery (included)
- Battery can be recharged via USB or any 12V outlet
- Charge a cell phone with the rechargeable battery
- Machine washable

» MEN'S • S-3XL • \$269⁹⁹
2869924 • DARK GRAY
» WOMEN'S • S-3XL • \$284⁹⁹
2869923 • DARK GRAY



WARM

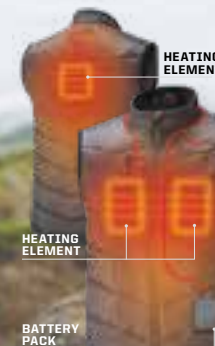



WOMEN'S ASYMMETRICAL HOODIE

» S-3XL • \$74⁹⁹
BLACK • 2868597

WOMEN'S ROSEAU TEE

» S-3XL • \$32⁹⁹
GRAY FROST • 2869559
BLACK • 2868586



MEN'S RETRO LOGO HOODIE

» S-3XL • \$74⁹⁹
BLACK • 2869549
CHARCOAL/LIME • 2868578
GRAY/ORANGE • 2868577

MEN'S RETRO CAP

» ONE SIZE • \$32⁹⁹
NAVY/LIME • 2869543

MEN'S ROSEAU HOODIE

» S-3XL • \$74⁹⁹
CHARCOAL HEATHER • 2869553
NAVY HEATHER • 2868575
OLIVE HEATHER • 2868576



MEN'S LONG SLEEVE TECH 1/4 ZIP

» S-3XL • \$79⁹⁹
BLACK/RED • 2869535
GRAY/LIME • 2869536



MEN'S TRAIL MID LAYER

» S-3XL • \$119⁹⁹
GRAY/BLACK • 2869925

MEN'S TECH MESH BEANIE

» ONE SIZE • \$26⁹⁹
BLACK • 2868650



CAMO WATER BOTTLE

» 2867962 • \$26⁹⁹

CAMO COFFEE TRAVEL MUG

» 2867961 • \$32⁹⁹

CAMO BOTTLE KOOZIE

» 2867964 • \$14⁹⁹

CAMO CAN KOOZIE

» 2867963 • \$8⁹⁹

CAMO STEERING WHEEL COVER

» 2868663 • \$19⁹⁹

CAMO BOTTLE OPENER (NOT SHOWN)

» 2867965 • \$14⁹⁹



WOMEN'S CAMO HOODIE

» S-3XL • \$74⁹⁹
CAMO/PINK • 2867898

MEN'S CAMO TECH FULL ZIP

» S-3XL • \$69⁹⁹
CAMO • 2869590



MEN'S RETRO TRUCKER CAP

» ONE SIZE • \$32⁹⁹
RED • 2869540

MEN'S LONG SLEEVE RETRO TEE

» S-3XL • \$54⁹⁹
GRAY • 2868571

WOMEN'S BASEBALL 3/4 SLEEVE TEE

» S-3XL • \$46⁹⁹
WHITE/GRAY • 2869563



PINT GLASS SET OF 2

» 2866265 • \$19⁹⁹

RETRO CLOCK

» 2868662 • \$39⁹⁹



MEN'S POLARIS GENERAL® CAP

» GRAY • \$32⁹⁹
S/M • 2868748
L/XL • 2868749

MEN'S POLARIS GENERAL® TEE

» S-3XL • \$32⁹⁹
GRAY • 2868767



MEN'S ESTA TEE

» S-3XL • \$26⁹⁹
CHARCOAL HEATHER • 2869552
NAVY • 2869562
BLACK • 2868570

MEN'S FULL ZIP HOODIE

» S-3XL • \$74⁹⁹
BLACK/RED • 2869530
NAVY • 2869532 (NOT SHOWN)

MEN'S RETRO CAP

» ONE SIZE • \$32⁹⁹
CHARCOAL • 2869542



WOMEN'S HEX TEE

» S-3XL • \$32⁹⁹
GRAY FROST • 2869566
NAVY FROST • 2869565

WOMEN'S RETRO CAP

» ONE SIZE • \$32⁹⁹
BLUE • 2869547

WOMEN'S SCRIPT CREW SWEATSHIRT

» S-2XL • \$67⁹⁹
AQUA • 2869557

WOMEN'S RETRO HOODIE

» S-3XL • \$67⁹⁹
NAVY • 2869555



MEN'S ROSEAU TEE

» S-3XL • \$32⁹⁹
CHARCOAL HEATHER • 2869560
HEATHER BLUE • 2867778
ASH HEATHER • 2869561

FIND YOUR NEXT ADVENTURE



BUILD THE MACHINE TO TAKE YOU THERE

Customize your Polaris GENERAL® with exactly what you need to ride comfortably and explore farther than you've ever gone before.



STEP 1
CHOOSE
MODEL



STEP 2
CHOOSE
TRIM & COLOR

STEP 3
CHOOSE
ACCESSORIES

EXPERIENCE OFF-ROAD LUXURY

- Windshield & Rear Panel P. 08
- Doors P. 10
- Roof P. 12
- Cab Comfort P. 14

NEXT LEVEL VERSATILITY

- Lighting P. 16
- Storage P. 18
- Wheel & Tires P. 22
- Winches P. 28

THE RIGHT STUFF TO MAINTAIN YOUR POLARIS GENERAL®

- Oil & Lubricants P. 30
- Maintenance P. 34

EVERYTHING YOU NEED TO GEAR UP

- Helmets P. 44
- Apparel P. 46

BUILD YOUR OWN AT
POLARIS.com/GENERAL

UNLESS NOTED, TRADEMARKS ARE THE PROPERTY OF POLARIS INDUSTRIES INC. 500® is a registered trademark of Teton Outfitters, LLC. Battery minder® is a registered trademark of VDC Electronics Inc. Can-Am® and COMMANDER® are registered trademarks of Bombardier Recreational Products Inc. CREE® is a registered trademark of Cree, Inc. Caliber® is a registered trademark of Caliber, Inc. COOL CORE® is a registered trademark of Tempology, LLC. MTX® is a registered trademark of Mitek Corporation. Right® is a registered trademark of Rigid Hitch, Inc. Yeti® is a registered trademark of Yeti Coolers, LLC. YKK® is a registered trademark of YKK Corporation. Bluetooth® is a registered trademark of Bluetooth SIG, Inc. Camoplast® is a registered trademark of Camoplast Solideal Inc. FOX® is a registered trademark of Fox Factory Inc. GoPro® is a registered trademark of GoPro Inc. Homelink® is a registered trademark of Johnson Controls Technology Inc. Maxxis® is a registered trademark of Cheng Shin Rubber Ind. Co., Ltd. Walker Evans® is a registered trademark of Walker Evans Enterprises Corp. Prices and availability are subject to change at any moment. Copyright © 2019 Polaris Industries, Inc. All rights reserved.

BUILD YOUR **POLARIS GENERAL**[®] & EXPLORE FARTHER

1 CHOOSE
MODEL

2 CHOOSE
TRIM & COLOR

3 CHOOSE
ACCESSORIES



VISIT [POLARIS.COM/GENERAL](https://www.polaris.com/general)

TO SEE ALL YOUR OPTIONS & ACCESSORIES
ON YOUR NEW MACHINE FROM EVERY ANGLE!



CONNECT ONLINE
SEARCH "PolarisORV"



KEEP IT COLD.



SEE P. 20



POLARIS[®]