

CANADA VERSION



POLARIS®

RANGER®

2019

ACCESSORIES + APPAREL



SEE THE FULL RANGER® LINEUP AT

[POLARIS.COM/RANGER](https://www.polaris.com/ranger)

DRIVEN TO DO MORE™



For 20-years, *RANGER*® has set the standard through industry-leading innovation, unmatched capability, and unrelenting toughness, making it the number one utility side-by-side for 10-years running.

2019 LINEUP



RANGER XP® 1000 EPS



RANGER CREW®
XP 1000 EPS



RANGER XP® 900 EPS



RANGER CREW®
XP 900 EPS



PRO ARMOR®
WHEELS & TIRES



POLARIS® PRO HD
WINCHES



RIGID® & PRO ARMOR®
LIGHTING



GLACIER® PLOW SYSTEMS



RANGER® 570 EPS



RANGER CREW® 570-4 EPS



RANGER® 500



RANGER® EV



3-SEAT & CREW MODELS & ACCESSORIES

COMMON ACCESSORIES

2-SEAT & CREW MODELS & ACCESSORIES

PARTS & GARAGE

APPAREL & HELMETS

2019 POLARIS® RANGER® ACCESSORIES

POLARIS ENGINEERED™ ACCESSORIES 02

3-SEAT & CREW

XP 1000 CAB SYSTEMS

- ROOFS	14
- GLASS WINDSHIELDS & REAR PANELS	16
- POLY WINDSHIELDS & REAR PANELS	18
- DOORS	20
- CAB COMFORT	24
- OFF-ROAD GRADE AUDIO SYSTEMS	28

XP 900 CAB SYSTEMS

- ROOFS	36
- GLASS WINDSHIELDS & REAR PANELS	38
- POLY WINDSHIELDS & REAR PANELS	40
- DOORS	42
- CAB COMFORT	44

570 FULL-SIZE & CREW

CAB COMPONENTS & PROTECTION 46

STORAGE 48

BRUSHGUARDS & PROTECTION 52

COMMON ACCESSORIES

WINCHES	54
GLACIER® PLOW SYSTEMS	58
RIGID® & PRO ARMOR® LIGHTING	64
PRO ARMOR® WHEELS & TIRES	66
POLARIS NORTHSTAR® COOLERS	74
HUNT	78
ICE FISHING	80

RANGER® 150 81

2-SEAT & CREW

- ROOFS	84
- WINDSHIELDS & REAR PANELS	86
- CAB COMFORT	90
- BUMPERS & GUARDS	91
- STORAGE	92

PARTS & GARAGE

OIL & LUBRICANTS	94
MAINTENANCE	96
SERVICE PARTS	100
POLARIS POWER®	102
GARAGE & TRAILERING	106

APPAREL & HELMETS

RIDING GEAR	108
CASUALWEAR	110

ALL LISTED PRICES ARE IN CANADIAN DOLLARS

KEEP YOUR **STANDARDS** HIGH

DESIGNED

POLARIS OFFERS THE BROADEST LINEUP OF ACCESSORIES AND MOST INNOVATIVE SOLUTIONS IN OFF-ROAD. EACH ONE IS METICULOUSLY CRAFTED TO MATCH YOUR MACHINE.



TESTED

BY THE TIME YOU GET THIS GEAR, PROTOTYPES HAVE GONE THROUGH HELL IN OUR LAB AND BEEN EXTENSIVELY TESTED IN THE FIELD. YOU RIDE WITH 100% CONFIDENCE.



TRUSTED

WE'VE EARNED RIDERS' TRUST OVER DECADES AND WE STAND BEHIND OUR WORK. EVERYTHING WITH OUR NAME ON IT COMES WITH A ONE-YEAR WARRANTY.

BACKED BY A



WARRANTY

POLARIS® PARTNERS WITH THE BEST

We choose our partners carefully, selecting only the best in off-road. Every accessory is rigorously tested and validated at Polaris® standards, to ensure seamless integration and performance.

PRO ARMOR®



WHEELS & TIRES P. 66
LED LIGHTS P. 64



RIGID®

LED LIGHTS P. 64



KOLPIN® OUTDOORS

ACCESSORIES P. 76

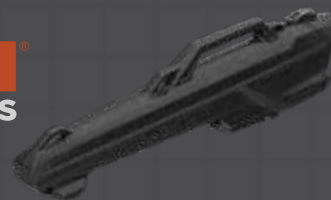

Otter®

ICE FISHING P. 80



MBQUART®

OFF-ROAD GRADE AUDIO P. 28

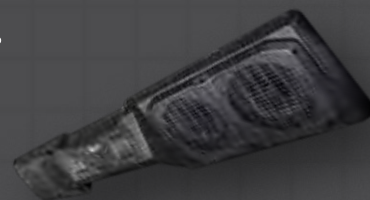

ENGINEERED FOR

Leaders never stop pushing for more. An unrelenting pursuit of innovation, performance and unyielding dependability defines *RANGER*® as the Hardest Working. Smoothest Riding.® utility vehicle in the world. Developed and tested along with the 2019 *RANGER XP*® 1000, Polaris Engineered Accessories™ are designed for seamless integration and simple installation, so riders can leverage the full capabilities of the machine and maximize efficiencies to get more done, year-round.

PRO PRO HEAVY DUTY SERIES **WINCHES**

INTEGRATED WINCH MOUNT & PRE-WIRED

Designated mounting points and pre-wired contactors ensure a perfect fit and the strongest place to attach the Polaris Engineered™ winch - the most dependable winch for your *RANGER*®. With wiring built right into the vehicle, we made this the easiest *RANGER*® winch ever made to install.

#GLACIER PLOW SYSTEM

INTEGRATED PLOW MOUNT

The attachment points for the best-in-class Glacier® Plow System are integrated right at the factory and feature an innovative drive-up and go installation process.



OR MORE



RANGER **PRO SHIELD™** CAB SYSTEM

THE TIGHTEST SEALING CAB

With the profile channels engineered into the roll cage, body plastics molded to seal and cab accessories designed to keep the elements out, the *RANGER* Pro Shield™ Cab System offers an industry-leading, 3x better dust seal than the competition.

LOCK & RIDE

CARGO BOX VERSATILITY

Lock & Ride® mounting locations allow for limitless customization to let you work the way you want.

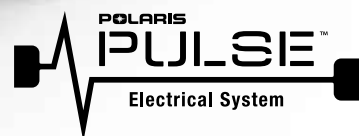

PLUG & PLAY ELECTRICAL

A revolution in electrical accessory integration, the Polaris Pulse™ Electrical System allows for a simple plug & play approach for adding power to Polaris Engineered Accessories™.

ALL-SEASON PROTECTION

RANGER



Look for the **RANGER PRO SHIELD™** Logo for the 4 components to customize your **RANGER®** with the industry's tightest sealing cab.



A FRAME DESIGNED FOR A CAB

All **RANGER®** cab components fit perfectly to the contours of the **RANGER XP® 1000** profile tube cab frame, floor and body panels, allowing for a 360° gasket seal, seamless fit and installation providing unprecedented protection from the elements.

1 CHOOSE YOUR ROOF

2 CHOOSE YOUR WINDSHIELD

3 CHOOSE YOUR REAR PANEL

4 CHOOSE YOUR DOORS



We set out to develop the best-performing, tightest-sealing cab on any utility Side x Side. Talk is cheap without proven results. Dust, water, noise - tested to military standards - all proved troublesome for the competition, but not for **RANGER Pro Shield™**.

The results speak for themselves.

THE RANGER PRO SHIELD™

MIL-STD 810G 510.5 DUST TEST

3x BETTER DUST SEAL

// RANGER PRO SHIELD™ VS. THE COMPETITION



HONDA® PIONEER®

5x MORE DUST

CAN-AM® DEFENDER

3x MORE DUST



3x BETTER DUST SEAL
THAN THE COMPETITION

AVAILABLE EXCLUSIVELY FOR
RANGER XP® 1000

CAB SYSTEM DOMINATES THE COMPETITION

MIL-STD 810G 506.5 RAIN TEST

1.5x BETTER RAIN SEAL

// RANGER PRO SHIELD™ VS. THE COMPETITION

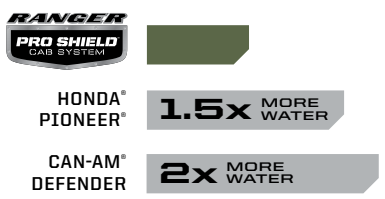

WIND TUNNEL TEST

2x BETTER NOISE REDUCTION

// RANGER PRO SHIELD™ VS. THE COMPETITION

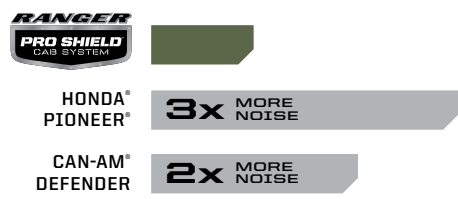

HONDA® and PIONEER® are registered trademarks of Honda Motor Co. Ltd. CAN-AM® and Defender are trademarks of Bombardier Recreational Products Inc.

RANGER PRO SHIELD™ DOORS.

THE INS & OUTS

OF THE BEST DOORS IN THE BUSINESS

360° GASKET SEAL

Complete seal all the way around the door connecting to the machine, sealing out drafts, dust & moisture.

EASY TO CLEAN TPE LINER

Soft to the touch, but durable and easy to maintain.

AUDIO-READY

Integrated mounting points for MBQuart® Speakers.

VENTILATION OPTIONS

Choose from Power or Manual Crank to adjust windows.

BUILT-IN STORAGE

Easy to access 100 cubic in. of storage.

Leaders never stop pushing for more. An unrelenting pursuit of innovation, performance and unyielding dependability defines **RANGER®** as the Hardest Working. Smoothest Riding.® utility vehicle in the world. These doors are a testament to that – riders can leverage the full capabilities of the machine and maximize efficiencies to get more done, year-round.

COMPLETE COVERAGE

Doors fit perfectly in the contours of the profile tube cab frame.

ULTIMATE CLARITY

Tempered Safety Glass, clear to see through and shatterproof.

COLOR MATCHED

Key-Color Matched accent panels available for all XP 1000 models.

EASY-ON/OFF HINGES

Once installed, the pin system allows for easy on & off.

DURABLE CONSTRUCTION

With a 1" tube steel frame these doors can handle the rigors of the off-road.

PROTECTION

Inner & Outer shells are made from high-quality, injection-molded plastics using a state-of-the-art process to shield from the elements and more.

AVAILABLE EXCLUSIVELY FOR
RANGER XP® 1000
SEE ALL DOOR OPTIONS ON P. 20

SUPERIOR

INTEGRATI

PRO

PRO HEAVY DUTY SERIES

WINCHES



POLARIS® PRO HD FEATURES



Tested 1,200+ pulls
at max load, it works
when you need it to



Built to withstand
-20° F temperatures



Sealed motor & heavy
duty gears **OPERATE**
FULLY SUBMERGED
UNDERWATER



RAPID ROPE
RECOVERY
5X faster rope retrieval

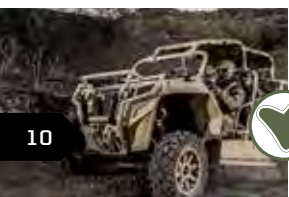

MILITARY
tested &
approved



FULLY INTEGRATED
MOUNT & WIRING

ON

POLARIS® PRO HD WINCHES + GLACIER® PLOW SYSTEMS

Right from the factory, your vehicle is built to make essential accessories like winches and plows easy to use day-in and day-out. Mounting brackets are designed into the oversized factory bumper and wiring is routed securely and properly. When it comes to *RANGER®*, Polaris Engineered Accessories™ make work easier so you can get more done.

PRE-WIRED CHASSIS

Dash mounted controls and wiring are installed at the factory. Mount the winch, connect the wires and trust that everything is routed safely, securely, and properly.

NO NEED TO CUT PANELS

GLACIER® PLOW SYSTEM



GLACIER® FEATURES

- ✓ To install the plow, simply lift the mount lock handle and pull forward.
- ✓ No loss of factory ground clearance when not plowing.
- ✓ Don't have to crawl under the machine to release the plow blade from the vehicle.
- ✓ No trimming of vehicle plastic or fascia required to mount plow or winch.

ANGLE YOUR BLADE RIGHT
FROM YOUR SEAT

25°

LEFT AND RIGHT



HUNT



View this RANGER® & make it your own
[POLARIS.COM/RANGERhunt1000](https://www.polaris.com/RANGERhunt1000)

RANGER XP® 1000 EPS
Polaris® Pursuit® Camo

WORK



RANGER XP®

WORK HARD AND GET IT DONE with Polaris Engineered Accessories™ for your RANGER®. Start with the ultimate in all-season performance and comfort with the best cab components in the industry. Then add in lighting, wheels, tires, a winch, Glacier® plows and more. Find everything you need to outfit your trusted partner for the task at hand.

MAKE

RANCH



View this RANGER® & make it your own
[POLARIS.COM/RANGERranch1000](https://www.polaris.com/RANGERranch1000)

RANGER CREW® XP 1000 EPS
Sage Green

TRAIL





View this RANGER® & make it your own
POLARIS.COM/RANGERwork1000

RANGER XP® 1000 EPS
 Steel Blue

1000 IT YOURS.



View this RANGER® & make it your own
POLARIS.COM/RANGERtrail1000

RANGER XP® 1000 EPS
 Magnetic Gray

RANGER XP® 1000 BUILD THE RIGHT TOOL FOR THE JOB.

CAB COMFORT WITH THE RANGER PRO SHIELD™ CAB SYSTEM

- Roof Pg 14
- Windshield Pg 16
- Rear Panel Pg 17
- Doors Pg 20
- Cab Comfort Pg 24
- Off-Road Grade Audio Pg 28

MAKE WORK EASIER WITH THE RIGHT TOOLS FOR THE JOB

- Polaris® Winches Pg 54
- Rigid® & Pro Armor® Lighting Pg 64
- Kolpin® & Polaris® Hunting Acces. Pg 76
- Cargo Bed Storage Options Pg 48
- GLACIER® Plow Systems Pg 58
- Pro Armor® Wheels & Tires Pg 66

THE RIGHT STUFF TO MAINTAIN YOUR RANGER®

- Oil & Lubricants Pg 94
- Maintenance Parts Pg 96

EVERYTHING YOU NEED TO GEAR UP FOR THE RIDE

- Apparel & Helmets Pg 108



BUILD YOUR OWN RANGER.®
POLARIS.COM/RANGER

OVERHEAD PROTECTION

TO SHIELD AGAINST DRIVING RAIN OR THE BLISTERING SUN, a roof is the first must-have of the Polaris Engineered™ cab components. Choose from poly, steel or canvas, and get on your way with protective peace of mind.



SEE AUDIO OPTIONS ON P. 28

POLY

Lightweight, durable and impact-resistant. A poly roof can take the abuse of a tough trail and still protect.

PREMIUM ROOF - POLY

- » POLARIS® PURSUIT® CAMO • 2882913 • \$929⁹⁹
 - » BLACK • 2882912 • \$699⁹⁹
- XP 1000 '17-19
* INCLUDES ROOF LINER



SPORT ROOF - POLY TOP SELLER

- » BLACK • 2882911 • \$429⁹⁹
- XP 1000 '17-19



PREMIUM ROOF LINER

- » 2882914 • \$269⁹⁹
- XP 1000 '17-19
* WORKS WITH 2882911, 2882912, 2882913



ROOF LINERS

Get a touch of premium comfort, reduce cab noise and hide wiring. Roof liners are included with all premium poly roofs, add a roof liner to your sport roof for added fit and finish.

POLARIS PULSE Electrical System **PLUG & PLAY**

ADD POWER TO PREMIUM & SPORT ROOFS - P. 26
ONLY ON XP 1000 & CREW XP 1000

STEEL

For the ultimate in strength and protection.

HD ROOF - STEEL

- » 2879881 • \$929⁹⁹
- XP 1000 '17-19
* ROOF LINER INCLUDED

CANVAS

Lightweight and easy to clean. Canvas roofs install simply and store easily.

LIGHTWEIGHT ROOF - CANVAS

- » 2879039 • \$339⁹⁹
- XP 1000 '17-19

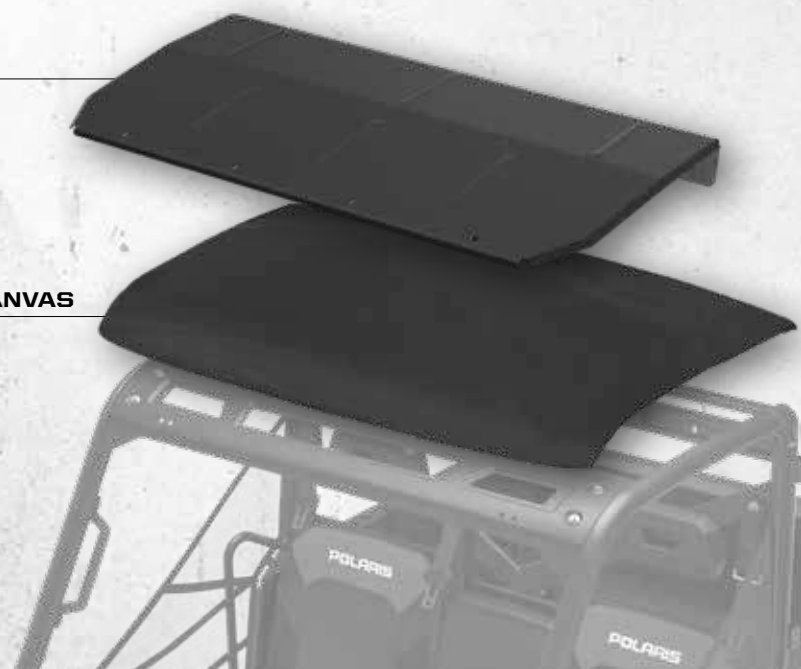

PREMIUM & SPORT ROOF FEATURES

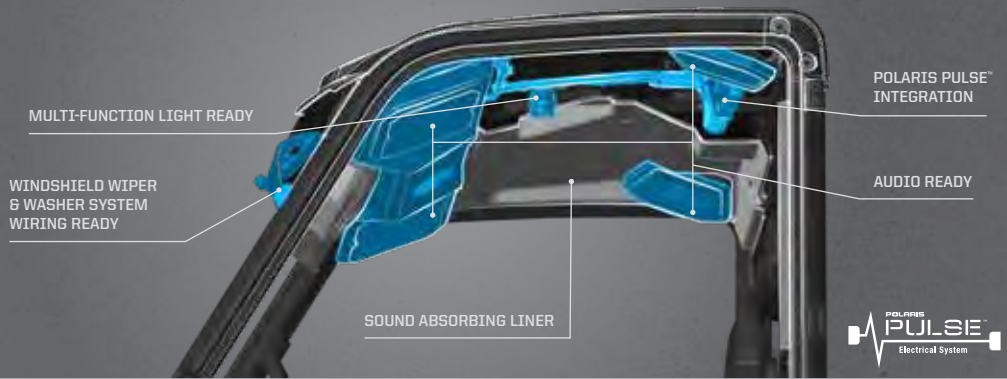

PREMIUM ROOF CREW - POLY

- » POLARIS® PURSUIT® CAMO PREMIUM • 2883277 • \$1,599⁹⁹ **NEW**
- CREW XP 1000 '17-19
- * ROOF LINER INCLUDED WITH CAMO

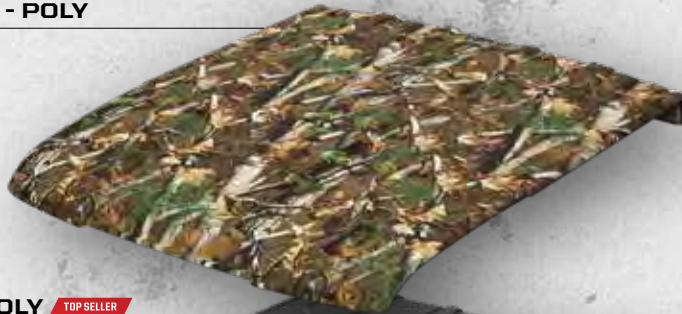

SPORT ROOF CREW - POLY **TOP SELLER**

- » BLACK • 2883274 • \$709⁹⁹ **NEW**
- CREW XP 1000 '17-19



PREMIUM ROOF CREW LINER

- » 2883457 • \$339⁹⁹ **NEW**
- CREW XP 1000 '17-19



HD ROOF CREW - STEEL

- » 2880334 • \$1,209⁹⁹
- CREW XP 1000 '17-19

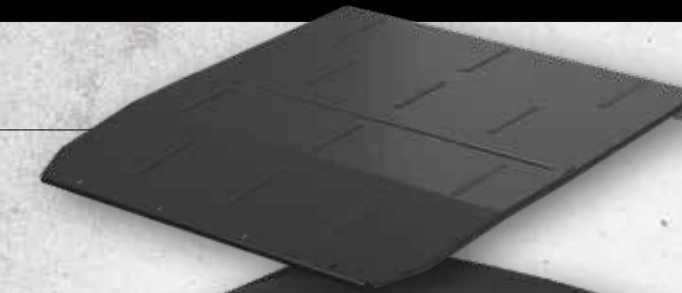

LIGHTWEIGHT ROOF CREW - CANVAS

- » 2879898 • \$539⁹⁹
- CREW XP 1000 '17-19



POLARIS ENGINEERED™ ADVANTAGES



SEALED COVERAGE

Just as roof shingles overlap for seamless coverage, roofs extend over other cab components to add even more protection against the elements, delivering the best fit - and the best seal.



KEEP MOISTURE MOVING

Keep precipitation moving with integrated roof water channels that direct water away from the cab even when you're stationary.



PREMIUM FINISH & QUIETER RIDE

Roof liners provide a clean look by hiding wiring, and absorb noise for a quieter ride.



REVOLUTIONARY INSTALLATION

Roofs install directly into mounting points in the cab frame.

3-SEAT & CREW

XP 1000

ROOFS

GLASS WINDSHIELDS & REAR PANELS

POLY WINDSHIELDS & REAR PANELS

DOORS

CAB COMFORT

AUDIO

STORAGE & PROTECTION

ULTIMATE CLARITY WITH GLASS

FOR THE ULTIMATE IN SCRATCH RESISTANCE AND CLARITY, nothing beats glass. It has the most optical clarity of any windshield material, so you can keep riding regardless of the weather. Reduce the dust swirl from the windshield and roof by adding a rear panel to keep the cab clean and comfortable.



WINDSHIELDS

3-Position Adjustable

Open
Venting
Closed



WIPER READY

TIP-OUT WINDSHIELD - GLASS TOP SELLER

- Offers 3 positions-open, closed and vented
- Tip-out design allows for partial venting or open-air freedom
- Gas shocks assist in easy opening and closing
- 360° gasket for reliable protection and comfort
- Automotive-style curved glass
- Scratch-resistant safety glass
- Improved interior sound dampening and optimized visibility
- Bolt-on design installs directly on the cab frame
- Designated mounting locations

» 2882874 • \$1,599⁹⁹
XP 1000 '18-19, CREW XP 1000 '19



ADD ALL-WEATHER VISIBILITY
WINDSHIELD WIPER & WASHER SYSTEM
P. 24

WIPER READY

LOCK & RIDE FULL WINDSHIELD - GLASS TOP SELLER

- Provides the highest level of scratch resistance

» 2882191 • \$929⁹⁹
XP 1000 '17-19, CREW XP 1000 '17-19





TEMPERED SAFETY GLASS

For the ultimate in scratch resistance, tempered safety glass is the top choice. Optically, it is the clearest glass available, and because it is tempered, it's shatterproof.

REAR PANELS

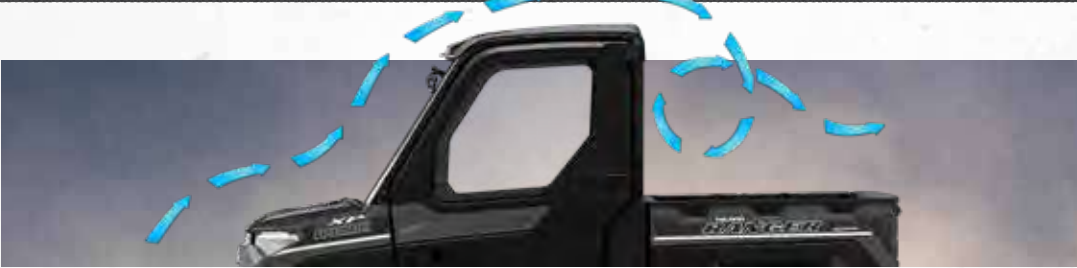

REDUCE IN-CAB DUST SWIRL BY ADDING A REAR PANEL
 With a windshield and roof installed, turbulent air develops behind the cab. Add a rear panel to reduce dust intrusion from this swirl.

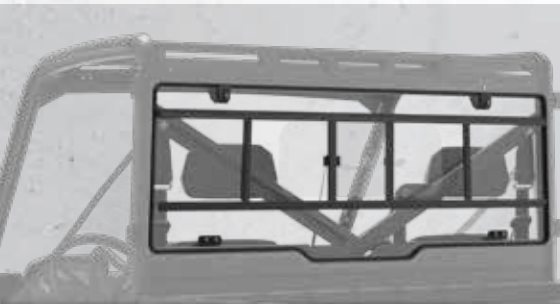

LOCK & RIDE

REAR PANEL - SLIDING GLASS

• Sliding window provides ventilation, cab comfort and access to cargo in rear box

» 2879015 • \$929⁹⁹

XP 1000 '17-19, CREW XP 1000 '17-19

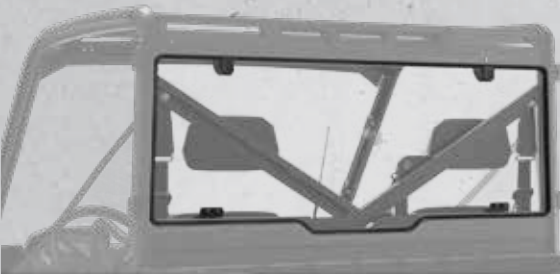

LOCK & RIDE

REAR PANEL - GLASS TOP SELLER

» 2879013 • \$509⁹⁹

XP 1000 '17-19, CREW XP 1000 '17-19



POLARIS ENGINEERED™ ADVANTAGES



AIRTIGHT GASKET SEAL

RANGER® windshields feature a 360° gasket seal, preventing moisture and dust from entering the cab.



MULTI-FUNCTION FEATURES

Venting options are useful for controlling airflow into the cab. This allows you to regulate the temperature inside. A low-profile exterior framework on the windshields gives an unobstructed field of vision.



REVOLUTIONARY INSTALLATION

Every Lock & Ride® windshield utilizes a unique clamp that secures your windshield with the perfect amount of hold for rough trail conditions, yet still allows for easy, tool-less removal.

3-SEAT & CREW

XP 1000

ROOFS

GLASS WINDSHIELDS
& REAR PANELS

POLY WINDSHIELDS
& REAR PANELS

DOORS

CAB COMFORT

AUDIO

STORAGE &
PROTECTION

DURABLE POLY PROTECTION

LIGHT AND FLEXIBLE, poly is impact-resistant, providing long-term value and protection. Whether you choose hard coat or general poly, you can hit the trail or job site with confidence, protection, and durability.

HARD COAT POLY

Poly windshields covered by hard coat provide **30x MORE** scratch resistance than any standard poly windshields.

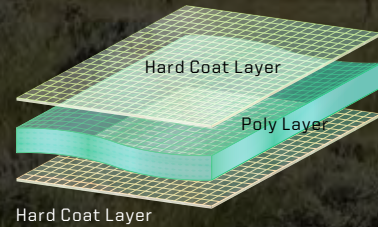

WINDSHIELDS



LOCK & RIDE

FULL WINDSHIELD VENTED - HARD COAT POLY TOP SELLER

- Frameless design for maximum visibility
- Added vents for airflow on a hot day or defrosting on a cold day

» 2883266 • \$739 ⁹⁹

XP 1000 '17-19, CREW XP 1000 '17-19



LOCK & RIDE

FULL WINDSHIELD - HARD COAT POLY

- Frameless design for maximum visibility

» 2883300 • \$669 ⁹⁹

XP 1000 '17-19, CREW XP 1000 '17-19



ADD ALL-WEATHER VISIBILITY
WINDSHIELD WIPER & WASHER SYSTEM
P. 24

HARD COAT POLY WINDSHIELD WIPER & WASHER SYSTEM MOUNTING BRACKET

- Required to use wiper on 2883266 or 2883300

» 2207624 • \$74 ⁹⁹

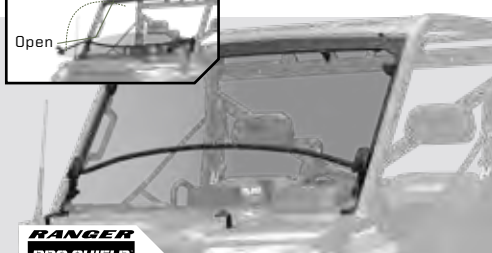
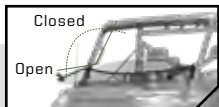

FLIP-DOWN WINDSHIELD - HARD COAT POLY

- Two venting options: fully sealed, flip-down or remove upper half for some protection with maximum ventilation

» 2883261 • \$609 ⁹⁹

XP 1000 '18-19, CREW XP 1000 '19



LOCK & RIDE

FULL WINDSHIELD - POLY

- Frameless design for maximum visibility

» 2883278 • \$539 ⁹⁹

XP 1000 '17-19, CREW XP 1000 '17-19



LOCK & RIDE

HALF WINDSHIELD - POLY

- Deflects air flow from straight on, but still provides air flow in the cab

» 2883301 • \$269 ⁹⁹

XP 1000 '17-19, CREW XP 1000 '17-19



POLARIS ENGINEERED™
ADVANTAGES

3-SEAT & CREW

XP 1000

ROOFS

GLASS WINDSHIELDS
& REAR PANELS

POLY WINDSHIELDS
& REAR PANELS

DOORS

CAB COMFORT

AUDIO

STORAGE &
PROTECTION



AIRTIGHT GASKET SEAL

RANGER® windshields feature a 360° gasket seal, preventing moisture and dust from entering the cab.

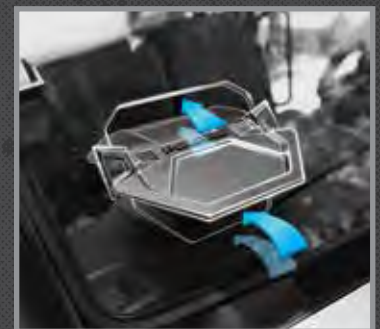

VENTING OPTIONS

Venting options are useful for controlling airflow into the cab. This allows you to regulate the temperature inside.



REVOLUTIONARY INSTALLATION

Every Lock & Ride® windshield utilizes a unique clamp that secures your windshield with the perfect amount of hold for rough trail conditions, yet still allows for easy, tool-less removal.

REAR PANELS

REDUCE IN-CAB DUST SWIRL BY ADDING A REAR PANEL

With a windshield and roof installed, turbulent air develops behind the cab. Add a rear panel to reduce dust intrusion from this swirl.



LOCK & RIDE

REAR PANEL - POLY POLARIS® PURSUIT® CAMO **NEW**

- Strong, thick polycarbonate provides outstanding impact and scratch resistance
- Installs in contours of cab frame with 360° gasketing for outstanding protection, comfort, fit and finish

» 2883774 • \$539⁹⁹

XP 1000 '17-19, CREW XP 1000 '17-19



LOCK & RIDE

REAR PANEL - POLY CLEAR **NEW TOP SELLER**

- Strong, thick polycarbonate provides outstanding impact and scratch resistance
- Installs in contours of cab frame with 360° gasketing for outstanding protection, comfort, fit and finish

» 2883773 • \$469⁹⁹

XP 1000 '17-19, CREW XP 1000 '17-19



LOCK & RIDE

REAR PANEL - CANVAS/POLY

- Heavy-duty cinch-tight buckles for a snug, secure fit
- Panel installs easily into integrated mounting locations

» 2879040 • \$269⁹⁹

CREW XP 1000 '17-18

RANGER XP[®] 1000



RANGER XP[®] 1000



PREMIUM POLY DOORS

POWER WINDOW DOORS



MANUAL CRANK WINDOW DOORS

HALF DOORS





DOOR STYLES



KEY FEATURES

RANGER PRO SHIELD™ CAB SYSTEM			
WINDOW TYPE	GLASS	GLASS	
WINDOW VENTILATION	POWER	MANUAL CRANK	OPEN TOP
VISIBILITY	UPPER	UPPER	UPPER
STORAGE COMPARTMENT	STANDARD	STANDARD	STANDARD
AUDIO-READY / SPEAKER MOUNT	STANDARD, PRE-WIRED	STANDARD	
PREMIUM TPE LINER	STANDARD	STANDARD	STANDARD
SPECIAL FEATURES	BUILT-IN FLOOR LIGHT, COLORED ACCENT PANELS AVAILABLE	COLORED ACCENT PANELS AVAILABLE	COLORED ACCENT PANELS AVAILABLE

CHOOSE THE RIGHT DOOR FOR YOU.

POLY DOORS		CANVAS DOORS
<i>RANGER® HUNTER DOORS</i>	<i>RANGER® CLEARVIEW DOORS</i>	<i>ZIP WINDOW DOORS</i>
		
		
GLASS	GLASS	CLEAR POLY
HINGED	HINGED	ZIPPED
UPPER	UPPER + LOWER	UPPER + PARTIAL LOWER
DURABLE POLY CONSTRUCTION, POLARIS® PURSUIT® CAMO	DURABLE POLY CONSTRUCTION	AVAILABLE IN POLARIS® PURSUIT® CAMO

RANGER XP[®] 1000

PREMIUM POLY DOOR FEATURES

- TPE Inside liner is soft to the touch & easy to clean
- Interior & Exterior easy to use handles
- Built-in storage
- 1" Tube frames & injection modeled rigid plastic
- Pre-designated mounts for speakers (front doors only)
- Integrated panels, allowing for color matching customization

See more detail on p. 20



PREMIUM POLY DOORS

POWER WINDOW

- The ultimate door offering power windows, switches mounted on the door and built-in floor light.

MANUAL CRANK WINDOW

- A premium, door offering manual crank windows for airflow adjustment in the cab.

HALF

- Provides lower protection from the off-road with an open-air experience.

EXTERIOR DOOR ACCENT PANELS

- Replace stock gloss black accent panels with color-matched accent panels
- Painted plastic and clear-coated for UV protection
- Install easily with a single screw
- Comes as a pair

Premium Doors come with Gloss Black Exterior Door Accent Panels, images below are shown with the optional Exterior Door Accent Panels.

FRONT DOORS
(SET OF 2) XP 1000 '18-'19, CREW XP 1000 '19



PULSE
Power Window Doors - Poly - Black
2882562 | \$3,989⁹⁹



RANGER PRO SHIELD
Manual Crank Window Doors - Poly - Black
2882561 | \$3,329⁹⁹



RANGER PRO SHIELD
Half Doors - Poly
2882559 | \$1,999⁹⁹

REAR DOORS
(SET OF 2) CREW XP 1000 '19



The Power Window Door is not an available option for the rear, the Manual Crank Window Door is recommended.



RANGER PRO SHIELD
Manual Crank Window Doors - Rear - Poly **NEW**
2883437 | \$3,329⁹⁹



RANGER PRO SHIELD
Half Doors - Rear - Poly **NEW**
2883438 | \$1,999⁹⁹

Color	Front Part Number XP 1000 '18-'19, CREW XP 1000 '19	Rear Part Number CREW XP 1000 '19
	Polaris® Pursuit® Camo 2882870-587 \$99 ⁹⁹	NEW 2883829-587 \$99 ⁹⁹
	NEW Steel Blue 2882870-765 \$43 ⁹⁹	
	NEW Pearl White 2882870-566 \$43 ⁹⁹	NEW 2883829-566 \$43 ⁹⁹
	NEW Magnetic Gray 2882870-603 \$43 ⁹⁹	
	NEW 20th Anniversary Edition / Maroon Metallic 2882870-754 \$43 ⁹⁹	NEW 2883829-754 \$43 ⁹⁹
	Sage Green 2882870-560 \$43 ⁹⁹	NEW 2883829-560 \$43 ⁹⁹
	Titanium Matte Metallic 2882870-632 \$43 ⁹⁹	
	Sunset Red Metallic 2882870-520 \$43 ⁹⁹	NEW 2883829-520 \$43 ⁹⁹
	Suede Metallic 2882870-577 \$43 ⁹⁹	



THE BEST CAB COMPLETED

GET UNMATCHED PERFORMANCE AND THE BEST SEAL
with the **RANGER Pro Shield™** Cab System door line.



SEE WHAT PEOPLE ARE SAYING ABOUT THESE DOORS
[YOUTUBE.COM/USER/POLARISORV](https://www.youtube.com/user/polarisorv)
SEARCH "DOORS"

POLY DOORS

CANVAS DOORS

RANGER® HUNTER

- Tough clear poly shell extends from the bottom of the door until it meets the upper-hinged glass window
- Premium Polaris® Pursuit™ Camo pattern offers extensive camo coverage

RANGER® CLEARVIEW

- Deliver nearly uninterrupted visibility and maximum ambient lighting inside the cab
- Tough clear poly shell extends from the bottom of the door until it meets the upper-hinged glass window

ZIP WINDOW

- Lightweight, durable protection with adjustable zipper ventilation and see-through bottom panel.



RANGER® Hunter Doors -
Polaris® Pursuit™ Camo
2883229 | \$2,929⁹⁹



RANGER® ClearView Doors
2882901 | \$2,659⁹⁹



Zip Window Doors -
Canvas - Black
2882902 | \$1,209⁹⁹

Zip Window Doors -
Canvas - Polaris® Pursuit™ Camo
2882903 | \$1,599⁹⁹



RANGER® Hunter Doors -
Rear - Polaris® Pursuit™ Camo **NEW**
2883633 | \$2,929⁹⁹



RANGER® ClearView Doors -
Rear **NEW**
2883632 | \$2,659⁹⁹



Zip Window Doors -
Rear - Canvas - Black **NEW**
2883634 | \$1,209⁹⁹

RANGER XP[®] 1000

ADD COMFORT AND CAPABILITY

XP 1000 CAB COMFORT

8-VENT HEATER & DEFROST SYSTEM

- Easily control the climate inside your cab in any season
- Helps defrost windshields & keeps you warm or cool
- Heat & fan dash-mounted controls
- Manual vents



» 2882753 • \$1,169⁹⁹

XP 1000 '18-19, CREW XP 1000 '19

HEATED SEAT SYSTEM

- Increase your comfort in the colder months with heated seats
- Installs into stock seats

» 2882905 • \$309⁹⁹

XP 1000 '18-19, CREW XP 1000 '19
CREW: FITS FRONT SEATS ONLY



FLOOR MATS

» 2882780 • \$169⁹⁹

XP 1000 '18-19, CREW XP 1000 '19
CREW: FITS FRONT SEATS ONLY

POLARIS[®] RANGER XP[®] FULL-SIZE SEATSAVER[®] - SPLIT BENCH SEAT

- Covers the back & bottom of seat

 » REALTREE XTRA[®] CAMO • 2883244-587 • \$299⁹⁹

 » CARHARTT[®] BROWN • 2883244-218 • \$269⁹⁹

 » CARHARTT[®] GRAVEL • 2883244-458 • \$269⁹⁹

XP 1000 '18-19, CREW XP 1000 '19
CREW: FITS FRONT SEATS ONLY

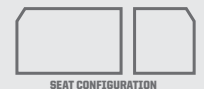

SEAT CONFIGURATION

CAB SEAL SYSTEM - 3 SEAT (INCLUDED WITH PREMIUM & POLY DOORS)

- Included in all Premium & Poly Doors

» 2883253 • \$134⁹⁹

XP 1000 '18-19, CREW XP 1000 '19



NOISE REDUCTION SYSTEM

» 2883489 • \$359⁹⁹

XP 1000 '18-19, CREW XP 1000 '19

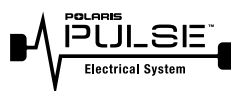

With Polaris PULSE™ it's easy to add all your electrical accessories. See p. 26 to learn more.



3-SEAT & CREW

XP 1000

ROOFS

GLASS WINDSHIELDS & REAR PANELS

POLY WINDSHIELDS & REAR PANELS

DOORS

CAB COMFORT

AUDIO

STORAGE & PROTECTION

XP 1000 CAB CONVENIENCE

WINDSHIELD WIPER & WASHER SYSTEM



- » 2882754 • \$669⁹⁹
XP 1000 '18-19, CREW XP 1000 '19

HARD COAT POLY WINDSHIELD WIPER & WASHER SYSTEM MOUNTING BRACKET

- » 2207624 • \$74⁹⁹
REQUIRED TO USE WIPER ON 2883266 OR 2883300

MULTI-FUNCTION CAB LIGHT



- LED dome light provide, white, red, green and blue lighting options
- Battery-operated and recharges when the vehicle is on
- Can be removed to use as a flashlight in and around your vehicle



- Red light is great for reading maps
- Green light is perfect for navigating in the dark
- Blue light is ideal for night riding

- » 2882871 • \$134⁹⁹
XP 1000 '18-19, CREW XP 1000 '19



HORN



- » 2882764 • \$89⁹⁹
XP 1000 '18-19, CREW XP 1000 '19

REVERSE WARNING ALERT

- » 2883246 • \$74⁹⁹
XP 1000 '18-19, CREW XP 1000 '19

LARGE REAR VIEW MIRROR

TOP SELLER

- » 2879969 • \$89⁹⁹
XP 1000 '17-19, CREW XP 1000 '17-19



WIDE ANGLE REAR VIEW MIRROR

- Large 2.5" x 14" adjustable convex mirrored surface gives you a full-spectrum view



- » 2881439 • \$179⁹⁹
XP 1000 '17-19, CREW XP 1000 '17-19



POLARIS® REMOTE GARAGE DOOR OPENER BY HOMELINK®

- HomeLink® technology allows you to control up to two garage doors

- » 2882082 • \$209⁹⁹
CREW XP 1000 '17
⚠ Requires Battery Connection Cable 2879685

WORK BEACON LED LIGHT

- 50' of illumination 360° around your vehicle
- Ideal for plowing, hunting and nighttime utility work
- Break-away construction protects the light in areas with tight clearance
- Mounted to the vehicle on the rear of the ROPS
- Easily hinge the light up during use and hinge it down when in transit

- » 2883265 • \$309⁹⁹
XP 1000 '18-19, CREW XP 1000 '19
Items Required for Installation:
Polaris PULSE® Wiring Harness - 1 LED Light Bar (2883230)



RANGER XP 1000

EASILY ADD ELECTRICAL ACCESSORIES

ADD **XP 1000** ELECTRICAL SYSTEM ACCESSORIES IN 4 EASY STEPS

STEP 1

CHOOSE A POLARIS PULSE™ READY ROOF	3-SEAT	CREW
Premium Roof - Poly - Polaris® Pursuit® Camo	2882913 \$929 ⁹⁹	2883277 \$1,599 ⁹⁹
Premium Roof - Poly - Black	2882912 \$699 ⁹⁹	
Sport Roof - Poly - Black	2882911 \$429 ⁹⁹	2883274 \$709 ⁹⁹

STEP 2

ADD THE POLARIS PULSE™ ROOF 6	3-SEAT	CREW
Polaris PULSE™ Roof 6	2882904 \$124 ⁹⁹	2882904 \$124 ⁹⁹

POLARIS PULSE™ UNDERHOOD BUS BAR



THE FOLLOWING ACCESSORIES EASILY PLUG INTO THE FACTORY INSTALLED POLARIS PULSE™ UNDER THE HOOD:

8-Vent Heater & Defrost System, Heated Seats P. 24

Bluetooth®, Apple® Control, AM/FM Dash Stereo & 2 x 5.25" Speakers by MB Quart® P. 29

Horn P. 25

Plow Controller P. 57

Light Bars P. 64

POLARIS PULSE™ READY ROOF WIRING EXAMPLE

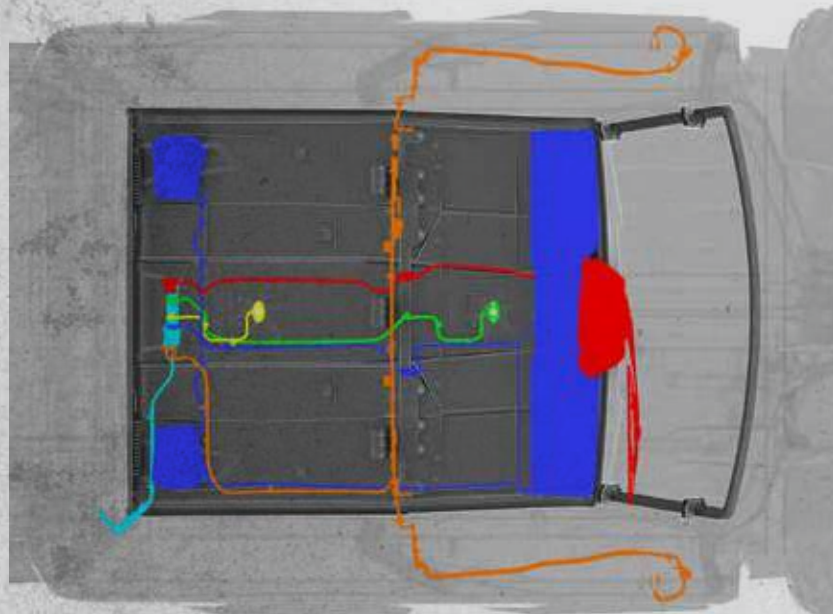

CREW XP 1000 POLARIS PULSE™ WIRING SHOWN



POLARIS PULSE™

Electrical System

Polaris PULSE™ is a revolutionary way to provide additional power locations on your vehicle, and makes adding electrical accessories a snap. Electrical accessories, such as dome lights or audio are easier to install on the roof, with designated routing areas and easy plug and play connections. Look for  to identify Polaris PULSE™ ready accessories.



2018-19 RANGER XP® 1000 & 2019 RANGER CREW® XP 1000

STEP 3 ADD ACCESSORIES

POWER WINDOW DOORS	3-SEAT	CREW
Power Window Doors - Poly - Black	2882562 \$3,989 ⁹⁹	2882562 \$3,989 ⁹⁹
Polaris PULSE™ Wiring Harness - Crew Extension		2883231 \$30 ⁹⁹

WINDSHIELD WIPER & WASHER SYSTEM	3-SEAT	CREW
Windshield Wiper & Washer System	2882754 \$669 ⁹⁹	2882754 \$669 ⁹⁹
Polaris PULSE™ Wiring Harness - Crew Extension		2883231 \$30 ⁹⁹

AUDIO: VISOR AUDIO + REAR SPEAKERS	3-SEAT	CREW
Bluetooth®, Apple® Control, AM/FM Visor Stereo & 4 x 6.5" Speakers by MB Quart®	2882888 \$1,069 ⁹⁹	2882888 \$1,069 ⁹⁹
2 x 6.5" 2-Way Rear Roof Speakers by MB Quart®	2882876 \$269 ⁹⁹	2882876 \$269 ⁹⁹
Polaris PULSE™ Wiring Harness - Crew Extension		2883231 \$30 ⁹⁹

AUDIO: DASH RADIO & VISOR SPEAKERS	3-SEAT	CREW
Bluetooth®, Apple® Control, AM/FM Dash Stereo & 2 x 5.25" Speakers by MB Quart®	2882750 \$809 ⁹⁹	2882750 \$809 ⁹⁹
4 x 6.5" 2-Way Visor Speakers by MB Quart®	2882891 \$809 ⁹⁹	2882891 \$809 ⁹⁹
Polaris PULSE™ Wiring Harness - Crew Extension		2883231 \$30 ⁹⁹

MULTI-FUNCTION DOME LIGHT	3-SEAT	CREW
Multi-Function Cab Light (Front) †	2882871 \$134 ⁹⁹	2882871 \$134 ⁹⁹
Polaris PULSE™ Wiring Harness - Crew Extension		2883231 \$30 ⁹⁹

†To add a Multi-Function Dome light for rear passengers, simply add an additional 2882871

STEP 4

CONCEAL WIRING FOR A FINISHED, COMFORTABLE LOOK	3-SEAT	CREW
Premium Roof Liner	2882914 \$269 ⁹⁹	2883457 \$339 ⁹⁹

EASILY ADD LIGHTING WITH POLARIS PULSE™



With Polaris Pulse™ it's easy to add Rigid® and Pro Armor® lighting to your RANGER®, all LED Light bars listed on pages 64-65 are Polaris Pulse™ ready, making installation that much easier.

POLARIS PULSE™ LIGHT BAR WIRING LOCATIONS

- FRONT BUMPER
- ROOF - FRONT MOUNTED
- ROOF - REAR MOUNTED
- *CREW ROOF - REAR MOUNTED (REQUIRES EXTENSION)

1 LIGHT WITH 1 SWITCH

- Polaris PULSE™ Wiring Harness - 1 LED Light Bar • 2883230 • \$114⁹⁹

2 LIGHTS WITH 1 SWITCH

- Polaris PULSE™ Wiring Harness - 1 LED Light Bar • 2883230 • \$114⁹⁹
- Y-Harness • 2878860 • \$23⁹⁹

2 LIGHTS WITH 2 SWITCHES

- Polaris PULSE™ Wiring Harness - 1 LED Light Bar • 2883230 • \$114⁹⁹
- Polaris PULSE™ Wiring Harness - 1 LED Light Bar • 2883230 • \$114⁹⁹

EXTENSIONS FOR CREW

- Polaris PULSE™ Wiring Harness - 1 LED Light Bar - Crew Extension • 2883231 • \$30⁹⁹

OFF-ROAD GRADE AUDIO

When you research audio solutions for Polaris® RANGER®, you'll see manufacturers bragging about how their audio equipment is "Marine Grade". Or worse yet, you'll discover for yourself that they are repackaged components built for automotive applications. MB Quart®, combined with Polaris®, engineers Off-Road Grade Audio equipment that's proven to deliver the loudest, crispest sound in the harshest conditions. Rain, snow, mud, heat, cold, dust – **ANY PLACE YOUR RANGER® EXCELS, SO WILL YOUR AUDIO.**

RAIN

SNOW



3-SEAT & CREW

XP 1000

ROOFS

GLASS WINDSHIELDS & REAR PANELS

POLY WINDSHIELDS & REAR PANELS

DOORS

CAB COMFORT

AUDIO

STORAGE & PROTECTION

MUD

SAND



OFF-ROAD GRADE AUDIO

MBQUART[®]

BUILD YOUR SYSTEM

1 SELECT YOUR
HEAD UNIT p. 31

2 CHOOSE YOUR
SPEAKERS p. 31

3 FIND YOUR
SYSTEM p. 32-33

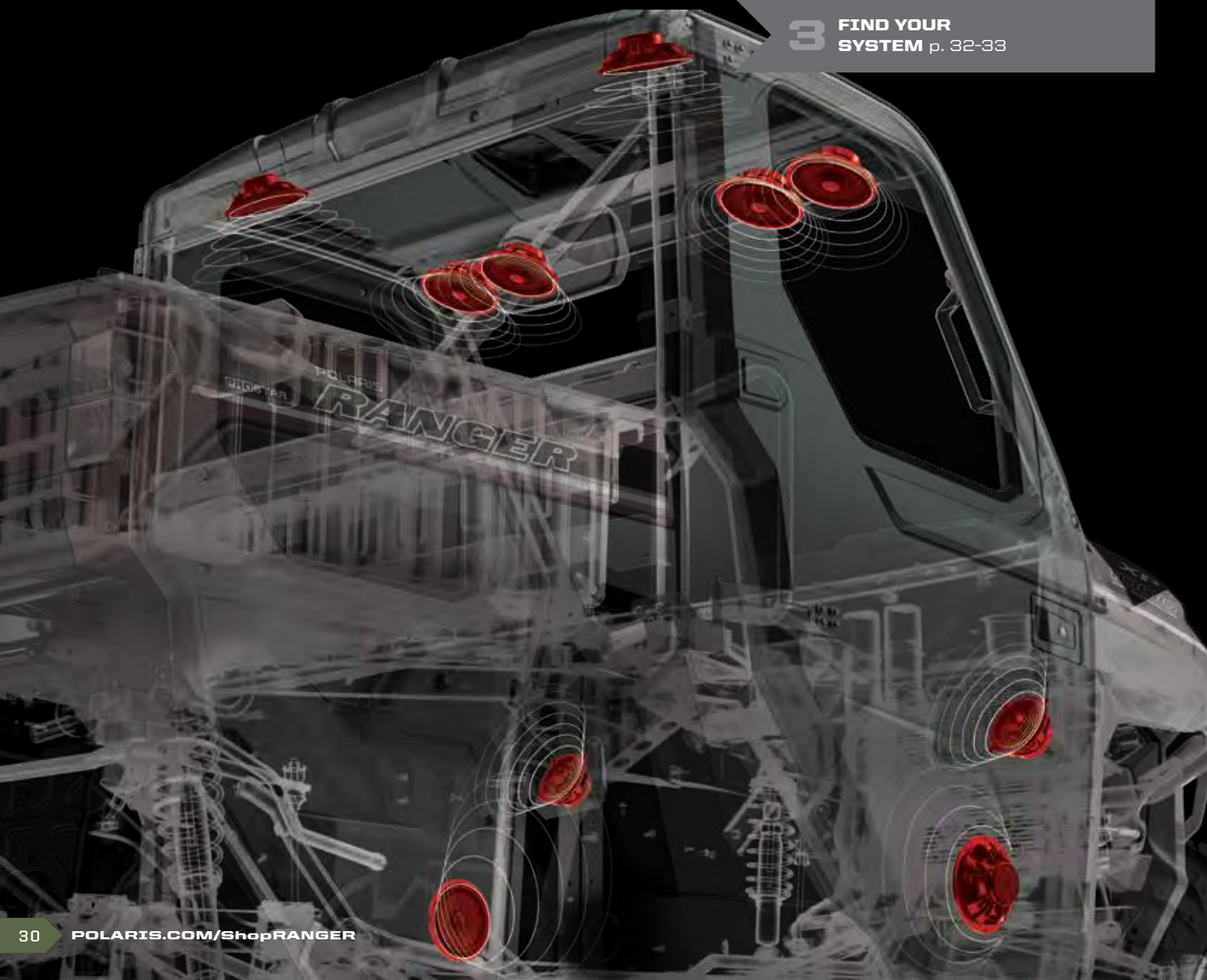

HEAD UNITS WITH SPEAKERS

These solutions get you well on your way to hitting the trails with your favorite tunes. Each features head units, allowing you to control audio delivery. Both the Dash Stereo and Visor Stereo are all-in-one solutions that can serve as the base and expanded system with more speakers.



BLUETOOTH®, APPLE® CONTROL, AM/FM DASH STEREO & 2 X 5.25" SPEAKERS BY MB QUART®

- All-in-one solution for giving your vehicle a performance-ready sound system
- AM/FM tuner with external antenna for reliable reception
- Powerful 45-watt x 4 channel amplifier
- Two off-road grade 5.25" speakers
- USB input and Bluetooth® compatible for wireless streaming
- System mounts into pre-designated mounting locations in the vehicle dash
- Easily add on other components to customize system

» 2882750 • \$809⁹⁹

XP 1000 '18-19, CREW XP 1000 '19

» 2882030 • \$809⁹⁹

CREW XP 1000 '17-18

⚠ Requires Battery Connection Cable



BLUETOOTH®, APPLE® CONTROL, AM/FM VISOR STEREO & 4 X 6.5" SPEAKERS BY MB QUART®

- One-step audio solution for your off-road vehicle audio system
- AM/FM/USB/Bluetooth® stereo with external antenna for reliable reception
- Integrated 300-watt amplifier
- Four 6.5" off-road grade coaxial speakers with .75" titanium dome tweeters
- Remote mount USB/3.5mm input plug for a dash panel
- Includes all of the necessary mounting hardware and new plug for wiring

» 2882888 • \$1,069⁹⁹

XP 1000 '18-19, CREW XP 1000 '19

ADD-ON SPEAKERS

Your *RANGER*® is ready for work, but is it ready to entertain? From a simple two-speaker setup to a complete system – BUILD IT YOUR WAY.



2 X 6.5" 2-WAY REAR ROOF SPEAKERS BY MB QUART®

- Enhance any audio system in your *RANGER*®
- Two 6.5" off-road grade coaxial speakers with .75" titanium dome tweeters
- Installs in the rear corners of the roof with simple hand tools
- Connects to either the Dash Audio Kit or the Premium Audio Visor

» 2882876 • \$269⁹⁹

XP 1000 '18-19, CREW XP 1000 '19



2 X 6.5" 2-WAY DOOR SPEAKERS BY MB QUART®

- Uncompromising sound quality & performance
- Two 6.5" off-road grade coaxial speakers with .75" titanium dome tweeters
- IPX67 rated
- Kit includes mounting hardware/harness and installs in minutes using simple hand tools

» 2882889 • \$269⁹⁹

XP 1000 '18-19, CREW XP 1000 '19



4 X 6.5" 2-WAY VISOR SPEAKERS BY MB QUART®

- Integrated 300-watt amplifier
- Four 6.5" off-road grade coaxial speakers with .75" titanium dome tweeters
- Installs easily under the *RANGER*® roof using simple hand tools
- 6 switch blanks offer convenient locations for additional switched accessories

» 2882891 • \$809⁹⁹

XP 1000 '18-19, CREW XP 1000 '19



BLUETOOTH®, APPLE® CONTROL, AM/FM DASH STEREO AMPLIFIER BY MB QUART®

- This add-on amplifier is used when adding additional speakers. See charts on following page for when necessary

» 2883408 • \$249⁹⁹

XP 1000 '18-19, CREW XP 1000 '19

3-SEAT & CREW

XP 1000

ROOFS

GLASS WINDSHIELDS & REAR PANELS

POLY WINDSHIELDS & REAR PANELS

DOORS

CAB COMFORT

AUDIO

STORAGE & PROTECTION

RANGER XP 1000

HEAD UNIT DASH STEREO & SPEAKERS

LOUDEST

ROOF + DOOR + VISOR SPEAKERS



10
SPEAKERS

HEAD UNIT

2882750 Dash Stereo \$809⁹⁹

SPEAKERS

2882876 Rear Roof Speakers* \$269⁹⁹
2882889 Door Speakers** \$269⁹⁹
2882891 Visor Speakers \$809⁹⁹

HARNESSES

2882904 Polaris PULSE™ Roof 6* \$124⁹⁹

TOTAL:

3-SEAT \$2,284⁹⁹

CREW*** \$2,315⁹⁹

XP 1000 '18-19, CREW XP 1000 '19

DOOR + VISOR SPEAKERS



8
SPEAKERS

HEAD UNIT

2882750 Dash Stereo \$809⁹⁹

SPEAKERS

2882889 Door Speakers** \$269⁹⁹
2882891 Visor Speakers \$809⁹⁹

HARNESSES

2882904 Polaris PULSE™ Roof 6* \$124⁹⁹

TOTAL:

3-SEAT \$2,014⁹⁹

CREW*** \$2,045⁹⁹

XP 1000 '18-19, CREW XP 1000 '19

REAR ROOF + VISOR SPEAKERS



8
SPEAKERS

HEAD UNIT

2882750 Dash Stereo \$809⁹⁹

SPEAKERS

2882876 Rear Roof Speakers* \$269⁹⁹
2882891 Visor Speakers \$809⁹⁹

HARNESSES

2882904 Polaris PULSE™ Roof 6* \$124⁹⁹

TOTAL:

3-SEAT \$2,014⁹⁹

CREW*** \$2,045⁹⁹

XP 1000 '18-19, CREW XP 1000 '19

VISOR SPEAKERS



6
SPEAKERS

HEAD UNIT

2882750 Dash Stereo \$809⁹⁹

SPEAKERS

2882891 Visor Speakers \$809⁹⁹

HARNESSES

2882904 Polaris PULSE™ Roof 6* \$124⁹⁹

TOTAL:

3-SEAT \$1,744⁹⁹

CREW*** \$1,775⁹⁹

XP 1000 '18-19, CREW XP 1000 '19

HEAD UNIT VISOR STEREO

LOUDEST

LOUD

REAR ROOF + DOOR SPEAKERS



8
SPEAKERS

HEAD UNIT

2882888 Visor Stereo \$1,069⁹⁹

SPEAKERS

2882876 Rear Roof Speakers* \$269⁹⁹
2882889 Door Speakers** \$269⁹⁹

HARNESSES

2882904 Polaris PULSE™ Roof 6* \$124⁹⁹

TOTAL:

3-SEAT \$1,734⁹⁹

CREW*** \$1,765⁹⁹

XP 1000 '18-19, CREW XP 1000 '19

REAR ROOF SPEAKERS



6
SPEAKERS

HEAD UNIT

2882888 Visor Stereo \$1,069⁹⁹

SPEAKERS

2882876 Rear Roof Speakers* \$269⁹⁹

HARNESSES

2882904 Polaris PULSE™ Roof 6* \$124⁹⁹

TOTAL:

3-SEAT \$1,464⁹⁹

CREW*** \$1,495⁹⁹

XP 1000 '18-19, CREW XP 1000 '19

DOOR SPEAKERS



6
SPEAKERS

HEAD UNIT

2882888 Visor Stereo \$1,069⁹⁹

SPEAKERS

2882889 Door Speakers** \$269⁹⁹

HARNESSES

2882904 Polaris PULSE™ Roof 6* \$124⁹⁹

TOTAL:

3-SEAT \$1,464⁹⁹

CREW*** \$1,495⁹⁹

XP 1000 '18-19, CREW XP 1000 '19

VISOR STEREO



4
SPEAKERS

HEAD UNIT

2882888 Visor Stereo \$1,069⁹⁹

HARNESSES

2882904 Polaris PULSE™ Roof 6* \$124⁹⁹

TOTAL:

3-SEAT \$1,194⁹⁹

CREW*** \$1,225⁹⁹

XP 1000 '18-19, CREW XP 1000 '19

AUDIO SYSTEMS

▶ LOUD

REAR ROOF + DOOR SPEAKERS



6

SPEAKERS

HEAD UNIT

2882750 Dash Stereo \$809⁹⁹

SPEAKERS

2882876 Rear Roof Speakers* \$269⁹⁹
2882889 Door Speakers** \$269⁹⁹

HARNESSES

2883408 Amplifier \$249⁹⁹

TOTAL:

3-SEAT \$1,599⁹⁹

CREW \$1,630⁹⁹

XP 1000 '18-19, CREW XP 1000 '19

REAR ROOF SPEAKERS



6

SPEAKERS

HEAD UNIT

2882750 Dash Stereo \$809⁹⁹

SPEAKERS

2882876 Rear Roof Speakers* \$269⁹⁹

HARNESSES

None Required

TOTAL:

3-SEAT \$1,079⁹⁹

CREW \$1,079⁹⁹

XP 1000 '18-19, CREW XP 1000 '19

DOOR SPEAKERS



4

SPEAKERS

HEAD UNIT

2882750 Dash Stereo \$809⁹⁹

SPEAKERS

2882889 Door Speakers** \$269⁹⁹

HARNESSES

None Required

TOTAL:

3-SEAT \$1,079⁹⁹

CREW \$1,079⁹⁹

XP 1000 '18-19, CREW XP 1000 '19

DASH STEREO + SPEAKERS



2

SPEAKERS

HEAD UNIT

2882750 Dash Stereo \$809⁹⁹

HARNESSES

None Required

TOTAL:

3-SEAT \$809⁹⁹

CREW \$809⁹⁹

XP 1000 '18-19, CREW XP 1000 '19

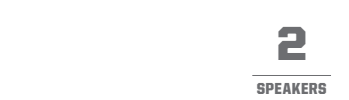

2

SPEAKERS

HEAD UNIT

2882030 Dash Radio \$809⁹⁹

HARNESSES

2879685 Battery Connection \$74⁹⁹

TOTAL:

CREW \$884⁹⁹

CREW XP 1000 '17-18



XP 1000 '18-19, CREW XP 1000 '19

* POLARIS PULSE™ READY ROOF REQUIRED - 3-SEAT: 2882911, 2882912 OR 2882913; CREW: 2883277 OR 2883274 AND POLARIS PULSE™ CREW EXTENSION 2993231

** REQUIRES DOORS: 2882562, 2882561 OR 2882559

*** TOTAL INCLUDES REQUIRED ITEM: 2883231 POLARIS PULSE™ CREW EXTENSION \$30.99

3-SEAT & CREW

XP 1000

ROOFS

GLASS WINDSHIELDS & REAR PANELS

POLY WINDSHIELDS & REAR PANELS

DOORS

CAB COMFORT

AUDIO

STORAGE & PROTECTION

HUNT



View this RANGER® & make it your own
[POLARIS.COM/RANGERhunt900](https://www.polaris.com/RANGERhunt900)

RANGER XP® 900 EPS
Military Tan

WORK

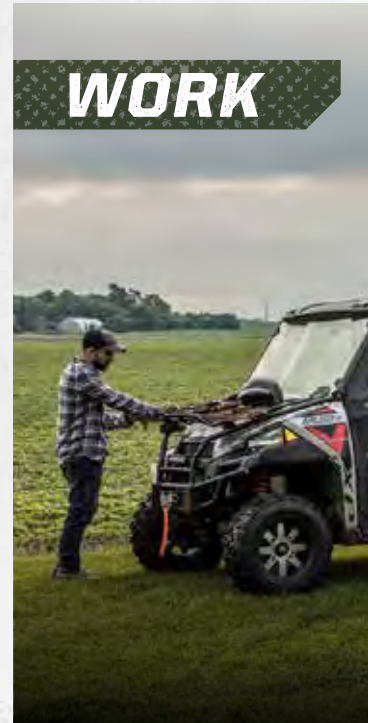

RANGER XP®

WORK HARD AND GET IT DONE with Polaris Engineered Accessories™ for your RANGER®. Start with the ultimate in all-season performance and comfort with the best cab components in the industry. Then add in lighting, wheels, tires, a winch, Glacier® plows and more. Find everything you need to outfit your trusted partner for the task at hand.

MAKE

RANCH



View this RANGER® & make it your own
[POLARIS.COM/RANGERranch900](https://www.polaris.com/RANGERranch900)

RANGER XP® 900 EPS
Sage Green

TRAIL





View this RANGER® & make it your own
POLARIS.COM/RANGERwork900

RANGER CREW® XP 900 EPS
 Turbo Silver

900 IT YOURS.



View this RANGER® & make it your own
POLARIS.COM/RANGERtrail900

RANGER XP® 900 EPS
 Orange Madness

RANGER XP® 900 BUILD THE RIGHT TOOL FOR THE JOB.

CAB COMFORT WITH THE RANGER PRO SHIELD™ CAB SYSTEM

- Roof Pg 36
- Windshield Pg 38
- Rear Panel Pg 39
- Doors Pg 42
- Cab Comfort Pg 44
- Off-Road Grade Audio Pg 45

MAKE WORK EASIER WITH THE RIGHT TOOLS FOR THE JOB

- Polaris® Winches Pg 54
- Rigid® & Pro Armor® Lighting Pg 64
- Kolpin® & Polaris® Hunting Acces. Pg 76
- Cargo Bed Storage Options Pg 48
- GLACIER® Plow Systems Pg 58
- Pro Armor® Wheels & Tires Pg 66

THE RIGHT STUFF TO MAINTAIN YOUR RANGER®

- Oil & Lubricants Pg 94
- Maintenance Parts Pg 96

EVERYTHING YOU NEED TO GEAR UP FOR THE RIDE

- Apparel & Helmets Pg 108



BUILD YOUR OWN RANGER.®
POLARIS.COM/RANGER

OVERHEAD PROTECTION

TO SHIELD AGAINST DRIVING RAIN OR THE BLISTERING SUN, a roof is the first must-have of the Polaris Engineered™ cab components. Choose from poly, steel or canvas, and get on your way with protective peace of mind.

POLY

Lightweight, durable and impact-resistant. A poly roof can take the abuse of a tough trail and still protect.

ROOF LINERS

Get a touch of premium comfort, reduce cab noise and hide wiring. Roof liners are included with all premium poly roofs.

STEEL

For the ultimate in strength and protection.

CANVAS

Lightweight and easy to clean. Canvas roofs install simply and store easily.

PREMIUM ROOF - POLY

- » POLARIS[®] PURSUIT[®] CAMO • 2882913 • \$929⁹⁹
- » BLACK • 2882912 • \$699⁹⁹
XP 900 '13-19, DIESEL '15-18
* INCLUDES ROOF LINER

SPORT ROOF - POLY TOP SELLER

- » BLACK • 2882911 • \$429⁹⁹
XP 900 '13-19, DIESEL '15-18

PREMIUM ROOF LINER

- » 2882914 • \$269⁹⁹
XP 900 '13-19, DIESEL '15-18
* WORKS WITH 2882911, 2882912, 2882913

HD ROOF - STEEL

- » 2879881 • \$929⁹⁹
XP 900 '13-19, DIESEL '15-18
* ROOF LINER INCLUDED

LIGHTWEIGHT ROOF - CANVAS

- » 2879039 • \$339⁹⁹
XP 900 '13-19, DIESEL '15-18

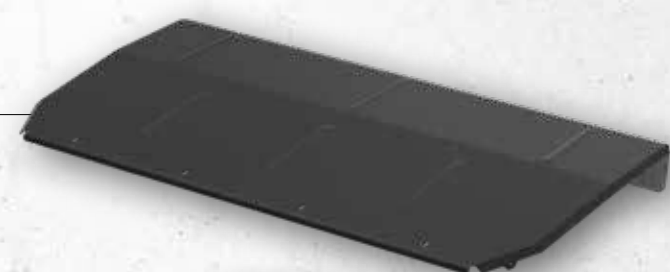
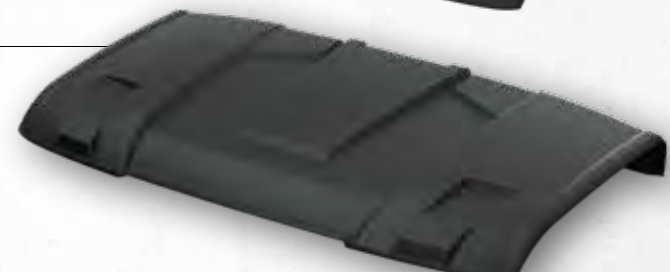



**PREMIUM ROOF
CREW - POLY** NEW

» POLARIS® PURSUIT® CAMO • 2883277 • \$1,599⁹⁹
 CREW XP 900 '14-19, CREW DIESEL '15-18
 * ROOF LINER INCLUDED WITH CAMO

**SPORT ROOF
CREW - POLY** NEW
TOP SELLER

» BLACK • 2883274 • \$709⁹⁹
 CREW XP 900 '14-19, CREW DIESEL '15-18

**PREMIUM ROOF
CREW LINER** NEW

» 2883457 • \$339⁹⁹
 CREW XP 900 '14-19, CREW DIESEL '15-18

**HD ROOF
CREW - STEEL**

» 2880334 • \$1,209⁹⁹
 CREW XP 900 '14-18, CREW DIESEL '15-18

**LIGHTWEIGHT
ROOF CREW - CANVAS**

» 2879898 • \$539⁹⁹
 CREW XP 900 '14-19, CREW DIESEL '15-18

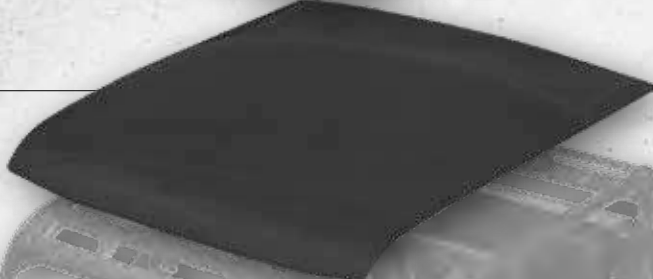
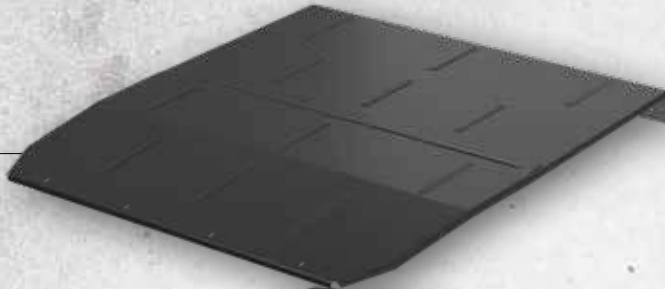

POLARIS ENGINEERED™
ADVANTAGES



SEALED COVERAGE

Just as roof shingles overlap for seamless coverage, roofs extend over other cab components to add even more protection against the elements, delivering the best fit - and the best seal.



KEEP MOISTURE MOVING

Keep precipitation moving with integrated roof water channels that direct water away from the cab even when you're stationary.



**PREMIUM FINISH &
QUIETER RIDE**

Roof liners provide a clean look by hiding wiring, and absorb noise for a quieter ride.



**REVOLUTIONARY
INSTALLATION**

Roofs install directly into mounting points in the cab frame.

3-SEAT & CREW

XP 900

ROOFS

GLASS WINDSHIELDS
& REAR PANELS

POLY WINDSHIELDS
& REAR PANELS

DOORS

CAB COMFORT

AUDIO

STORAGE &
PROTECTION

ULTIMATE CLARITY WITH GLASS

FOR THE ULTIMATE IN SCRATCH RESISTANCE AND CLARITY, nothing beats glass. It has the most optical clarity of any windshield material, so you can keep riding regardless of the weather. Reduce the dust swirl from the windshield and roof by adding a rear panel to keep the cab clean and comfortable.

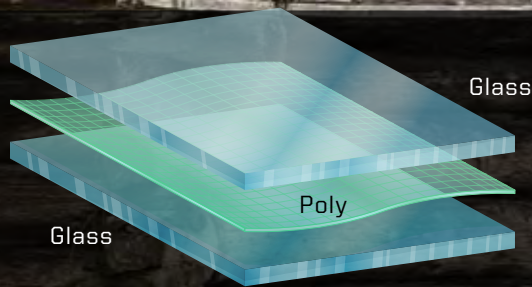

TEMPERED SAFETY GLASS

For the ultimate in scratch resistance, tempered safety glass is the top choice. Optically, it is the clearest glass available, and because it is tempered, it's shatterproof.

WINDSHIELDS

3-Position Adjustable

Open
Venting
Closed



WIPER READY



TIP-OUT WINDSHIELD - GLASS TOP SELLER

- Offers 3 positions—open, closed and vented
- Tip-out design allows for partial venting or open-air freedom
- Gas shocks assist in easy opening and closing
- 360° gasket for reliable protection and comfort
- Automotive-style curved glass
- Scratch-resistant safety glass
- Improved interior sound dampening and optimized visibility
- Bolt-on design installs directly on the cab frame
- Designated mounting locations

» 2882189 • \$1,599⁹⁹

XP 900 '14-19, CREW XP 900 '14-19, DIESEL '15-18, CREW DIESEL '15-18

WIPER READY



ADD ALL-WEATHER VISIBILITY
WINDSHIELD WIPER & WASHER SYSTEM
P. 44

LOCK & RIDE FULL WINDSHIELD - GLASS TOP SELLER

- Provides the highest level of scratch resistance

» 2882191 • \$929⁹⁹

XP 900 '13-19, CREW XP 900 '14-19, DIESEL '15-18, CREW DIESEL '15-18



AIRTIGHT GASKET SEAL

RANGER® windshields feature a 360° gasket seal, preventing moisture and dust from entering the cab.



MULTI-FUNCTION FEATURES

Venting options are useful for controlling airflow into the cab. This allows you to regulate the temperature inside. A low-profile exterior framework on the windshields gives an unobstructed field of vision.

REAR PANELS

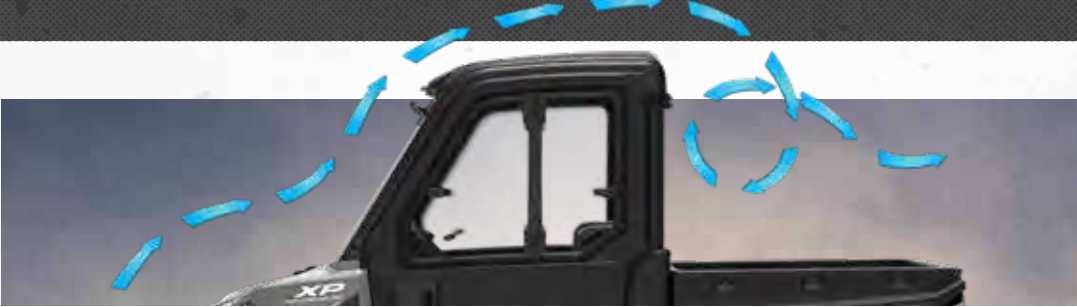

REDUCE IN-CAB DUST SWIRL BY ADDING A REAR PANEL
With a windshield and roof installed, turbulent air develops behind the cab. Add a rear panel to reduce dust intrusion from this swirl.

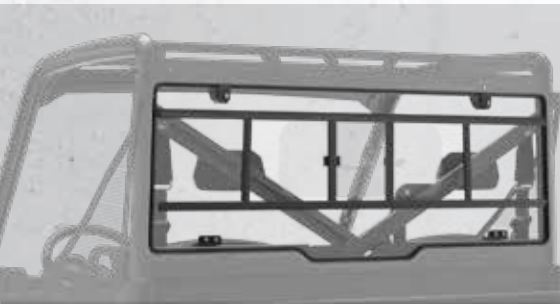

LOCK & RIDE

REAR PANEL - SLIDING GLASS

• Sliding window provides ventilation, cab comfort and access to cargo in rear box

» 2879015 • \$929⁹⁹

XP 900 '13-19, CREW XP 900 '14-19,
DIESEL '15-18, CREW DIESEL '15-18



LOCK & RIDE

REAR PANEL - GLASS TOP SELLER

» 2879013 • \$509⁹⁹

XP 900 '13-19, CREW XP 900 '14-19,
DIESEL '15-18, CREW DIESEL '15-18



REVOLUTIONARY INSTALLATION

Every Lock & Ride® windshield utilizes a unique clamp that secures your windshield with the perfect amount of hold for rough trail conditions, yet still allows for easy, tool-less removal.

DURABLE POLY PROTECTION

LIGHT AND FLEXIBLE, poly is impact-resistant, providing long-term value and protection. Whether you choose hard coat or general poly, you can hit the trail or job site with confidence, protection, and durability.

HARD COAT POLY

Poly windshields covered by hard coat provide **30x MORE** scratch resistance than any standard poly windshields.

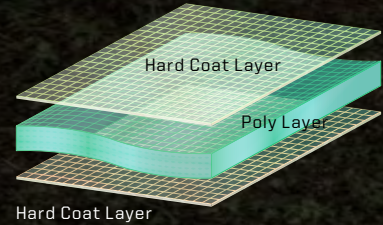

WINDSHIELDS

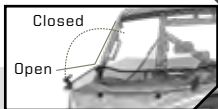

FLIP-DOWN WINDSHIELD - HARD COAT POLY

- Two venting options: fully sealed, flip-down or remove upper half for some protection with maximum ventilation

» 2881919 • \$609⁹⁹

XP 900 '13-19, CREW XP 900 '14-19, DIESEL '15-18, CREW DIESEL '15-18

LOCK & RIDE

FULL WINDSHIELD VENTED - HARD COAT POLY

- Frameless design for maximum visibility
- Added vents for airflow on a hot day or defrosting on a cold day

» 2883266 • \$739⁹⁹

XP 900 '13-19, CREW XP 900 '14-19, DIESEL '15-18, CREW DIESEL '15-18

LOCK & RIDE

FULL WINDSHIELD - HARD COAT POLY

TOP SELLER

- Frameless design for maximum visibility

» 2883300 • \$669⁹⁹

XP 900 '13-19, CREW XP 900 '14-19, DIESEL '15-18, CREW DIESEL '15-18

3-Position Adjustable

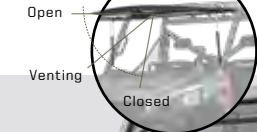

ADD ALL-WEATHER VISIBILITY
WINDSHIELD WIPER & WASHER SYSTEM
P. 40

WIPER & WASHER SYSTEM MOUNTING BRACKET

» 2207624 • \$74⁹⁹



TIP-OUT WINDSHIELD - POLY

- 3-position adjustable to control cab airflow
- New improved handle

» 2880091 • \$1,209⁹⁹

XP 900 '13-19, CREW XP 900 '14-19, DIESEL '15-18, CREW DIESEL '15-18

LOCK & RIDE

FULL WINDSHIELD - POLY

- Frameless design for maximum visibility

» 2883278 • \$539⁹⁹

XP 900 '13-19, CREW XP 900 '14-19, DIESEL '15-18, CREW DIESEL '15-18

LOCK & RIDE

HALF WINDSHIELD - POLY

- Deflects air flow from straight on, but still provides air flow in the cab

» 2879135 • \$269⁹⁹

XP 900 '13-19, CREW XP 900 '14-19, DIESEL '15-18, CREW DIESEL '15-18

POLARIS ENGINEERED™
ADVANTAGES

3-SEAT & CREW

XP 900

ROOFS

GLASS WINDSHIELDS
& REAR PANELS

POLY WINDSHIELDS
& REAR PANELS

DOORS

CAB COMFORT

AUDIO

STORAGE &
PROTECTION



AIRTIGHT GASKET SEAL

RANGER® windshields feature a 360° gasket seal, preventing moisture and dust from entering the cab.

REAR PANELS

REDUCE IN-CAB DUST SWIRL BY ADDING A REAR PANEL

With a windshield and roof installed, turbulent air develops behind the cab. Add a rear panel to reduce dust intrusion from this swirl.

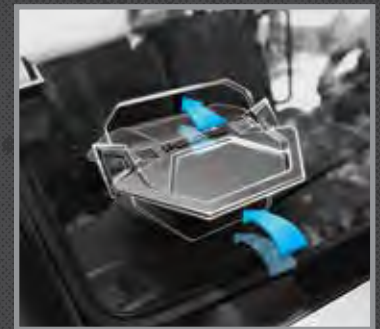

VENTING OPTIONS

Venting options are useful for controlling airflow into the cab. This allows you to regulate the temperature inside.



LOCK & RIDE

REAR PANEL - POLY POLARIS® PURSUIT® CAMO **NEW**

- Strong, thick polycarbonate provides outstanding impact and scratch resistance
- Installs in contours of cab frame with 360° gasketing for outstanding protection, comfort, fit and finish

» 2883774 • \$539⁹⁹

XP 900 '13-19, CREW XP 900 '14-19, DIESEL '15-18, CREW DIESEL '15-18



LOCK & RIDE

REAR PANEL - POLY CLEAR **NEW TOP SELLER**

- Strong, thick polycarbonate provides outstanding impact and scratch resistance
- Installs in contours of cab frame with 360° gasketing for outstanding protection, comfort, fit and finish

» 2883773 • \$469⁹⁹

XP 900 '13-19, CREW XP 900 '14-19, DIESEL '15-18, CREW DIESEL '15-18



LOCK & RIDE

REAR PANEL - CANVAS/POLY

- Heavy-duty cinch-tight buckles for a snug, secure fit
- Panel installs easily into integrated mounting locations

» 2879040 • \$269⁹⁹

XP 900 '13-19, CREW XP 900 '14-19, DIESEL '15-18, CREW DIESEL '15-18



REVOLUTIONARY INSTALLATION

Every Lock & Ride® windshield utilizes a unique clamp that secures your windshield with the perfect amount of hold for rough trail conditions, yet still allows for easy, tool-less removal.

RANGER XP[®] 900



PREMIUM POLY DOORS

POLY DOORS

POWER WINDOW

- The ultimate door offering power windows with switches mounted on the dash.

HINGED & FIXED WINDOW

- A premium, door offering hinged windows for airflow adjustment in the cab.
- Front Windows feature Glass

RANGER[®] CLEARVIEW

- Deliver nearly uninterrupted visibility and maximum ambient lighting inside the cab
- Clear poly shell extends from the bottom of the door until the upper-hinged glass window

POLY REAR DOOR LINERS

- Add comfort, a finished look, reduce interior cab noise.

FRONT DOORS (SET OF 2)
XP 900 '13-19, CREW XP 900 '14-19, DIESEL '15-18, CREW DIESEL '15-18



Power Window Doors - Poly - Black
2880503 | \$3,469⁹⁹

⚠ Requires Battery Connection Cable
DOES NOT FIT HVAC MODELS
DOES NOT FIT CREW MODELS



Hinged Window Doors - Poly - Black
2881253 | \$3,199⁹⁹

Hinged Window Doors - Poly - Polaris[®] Pursuit[™] Camo
2881460 | \$4,259⁹⁹



RANGER[®] ClearView Doors
2882188 | \$2,659⁹⁹

REAR DOORS (SET OF 2)
CREW XP 900 '14-19, CREW DIESEL '15-18

The Power Window Door is not an available option for the rear, the Fixed Window Door is recommended.



Fixed Window Doors - Rear - Poly
2879641 | \$2,399⁹⁹

Fixed Window Doors - Rear Poly - Polaris[®] Pursuit[™] Camo
2880641 | \$3,599⁹⁹



Poly Rear Door Liners
2882197 | \$339⁹⁹

GET UNMATCHED PERFORMANCE

with the RANGER® Cab System door line.

CANVAS DOORS

ZIP WINDOW

- Lightweight, durable protection with adjustable zipper ventilation and see-through bottom panel.



Zip Window Doors -
Canvas - Black
2878853 |
\$1,209⁹⁹

Zip Window Doors -
Canvas - Polaris® Pursuit® Camo
2882195 |
\$1,479⁹⁹

STEEL DOORS

HALF DOORS

- Keep the trail debris out while maintaining great airflow into the cab.
- Heavy-duty steel frame with slam latch fits perfectly to the chassis.



Half Doors -
Steel - Black
2879797 | \$1,069⁹⁹



Zip Window Doors - Rear
- Canvas - Black
2879899 | \$1,209⁹⁹

POLARIS ENGINEERED™ ADVANTAGES



PREMIUM FEATURES

Premium finish, solid latches, storage and more.

QUIETER AT IDLE

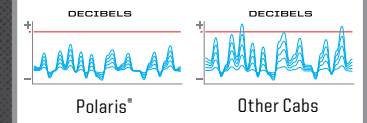

SOUND DAMPENING DOOR LINERS

Select doors come standard with sound-absorbing liners to help reduce in-cab noise.



UNPRECEDENTED VENTILATION OPTIONS

Choose from multiple window options –including power, hinged and zipper windows. This allows you to find the perfect amount of ventilation and temperature regulation.



REVOLUTIONARY INSTALLATION

Adding or removing your doors is as simple as dropping them in and pulling them off. Easy, convenient, and takes only seconds to remove the restraint rubber strap.

3-SEAT & CREW

XP 900

ROOFS

GLASS WINDSHIELDS & REAR PANELS

POLY WINDSHIELDS & REAR PANELS

DOORS

CAB COMFORT

AUDIO

STORAGE & PROTECTION

RANGER XP® 900

ADD COMFORT AND CAPABILITY

XP 900 CAB COMFORT



8-VENT HEATER & DEFROST SYSTEM TOP SELLER

- Easily control the climate inside your cab in any season
- Helps defrost windshields and keeps you warm or cool
- Heat and fan dash-mounted controls
- Manual vents

» 2880023 • \$1,029⁹⁹

XP 900 '13-19, CREW XP 900 '14-19, DIESEL '15-18, CREW DIESEL '15-18
 ⚠ Requires Battery Connection Cable

NOISE REDUCTION SYSTEM

» 2881508 • \$359⁹⁹

XP 900 '13-19, CREW XP 900 '14-19, DIESEL '15-18, CREW DIESEL '15-18

EPS SYSTEM (ELECTRIC POWER STEERING)

» 2880083 • \$1,739⁹⁹

XP 900 '13-19, CREW XP 900 '14-19, DIESEL '15-18, CREW DIESEL '15-18

ROOF SEAL SYSTEM - 3-PASSENGER

- Included in all Premium & Poly Doors

» 2879289 • \$64⁹⁹

XP 900 '13-19, DIESEL '15-18

HEATED SEAT SYSTEM

- Increase your comfort in the colder months with heated seats
- Installs into stock seats

» 2879271 • \$309⁹⁹

XP 900 '13-19, CREW XP 900 '14-19, DIESEL '15-18, CREW DIESEL '15-18
 CREW: FITS FRONT SEATS ONLY
 ⚠ Requires Battery Connection Cable

CAB SEAL SYSTEM - 3-PASSENGER / CREW FRONT

- Included with Premium Rear Doors

» 2879385 • \$339⁹⁹

XP 900 '13-19, CREW XP 900 '14-19, DIESEL '15-18, CREW DIESEL '15-18

CAB SEAL SYSTEM - CREW REAR

- Included with Premium Rear Doors

» 2879657 • \$239⁹⁹

CREW XP 900 '14-19, CREW DIESEL '15-18

POLARIS® RANGER XP® FULL-SIZE SEATSAVER® - SPLIT BENCH SEAT

- Covers the back & bottom of seat

» REALTREE XTRA® CAMO • 2882352-587 • \$299⁹⁹

» CARHARTT® BROWN • 2882352-218 • \$269⁹⁹

» CARHARTT® GRAVEL • 2882352-458 • \$269⁹⁹

XP 900 '13-19, CREW XP 900 '14-19, DIESEL '15-18, CREW DIESEL '15-18
 CREW: FITS FRONT SEATS ONLY

FULL-SIZE SEATSAVER® - FULL BENCH SEAT

- Covers the back & bottom of seat

» REALTREE XTRA® CAMO • 2882351-587 • \$299⁹⁹

» CARHARTT® BROWN • 2882351-218 • \$269⁹⁹

» CARHARTT® GRAVEL • 2882351-458 • \$269⁹⁹

XP 900 '13-19, CREW XP 900 '14-19, DIESEL '15-18, CREW DIESEL '15-18
 CREW: FITS FRONT SEATS ONLY

XP 900 CAB CONVENIENCE

WINDSHIELD WIPER & WASHER SYSTEM TOP SELLER

» 2879754 • \$669⁹⁹

XP 900 '13-19, CREW XP 900 '14-19, DIESEL '15-18, CREW DIESEL '15-18
 ⚠ Requires Battery Connection Cable

HARD COAT POLY WINDSHIELD WIPER & WASHER MOUNTING BRACKET NEW

- Works with Hard Coat Poly Windshields 2883266 & 2883300

» 2207624 • \$74⁹⁹

XP 900 '13-19, CREW XP 900 '14-19, DIESEL '15-18, CREW DIESEL '15-18

LARGE REAR VIEW MIRROR TOP SELLER

» 2879969 • \$89⁹⁹

XP 900 '13-19, CREW XP 900 '14-19, DIESEL '15-18, CREW DIESEL '15-18

WIDE ANGLE REAR VIEW MIRROR

- Large 2.5" x 14" adjustable convex mirrored surface gives you a full-spectrum view

» 2881439 • \$179⁹⁹

XP 900 '13-19, CREW XP 900 '14-19, DIESEL '15-18, CREW DIESEL '15-18



GATED SHIFTER

- Creates positive shift points between forward and reverse gears

- Eliminates accidental shifts to park or high-range

» 2880834 • \$134⁹⁹

XP 900 '13-19, CREW XP 900 '14-19, DIESEL '15-18, CREW DIESEL '15-18

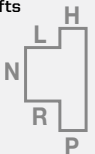

DOME LIGHT

- Fits Poly and Premium Roofs only see page 36

» 2879270 • \$99⁹⁹

XP 900 '13-19, CREW XP 900 '14-19, DIESEL '15-18, CREW DIESEL '15-18

REVERSE WARNING ALERT

» 2876228 • \$74⁹⁹

XP 900 '13-19, CREW XP 900 '14-19, DIESEL '15-18, CREW DIESEL '15-18

DIESEL BLOCK HEATER

» 2880826 • \$249⁹⁹

DIESEL '15-18, CREW DIESEL '15-18

SPEEDKEY®

- Alternate key governs vehicle speed to 25 mph max. Vehicle owner controls level of power available.

» 2879988 • \$409⁹⁹

XP 900 '14-19, CREW XP 900 '14-19

HORN

» 2879273 • \$89⁹⁹

XP 900 '13-19, CREW XP 900 '14-19, DIESEL '15-18, CREW DIESEL '15-18

WIRING YOUR XP 900

ADD ELECTRICAL SYSTEM ACCESSORIES IN 3 EASY STEPS

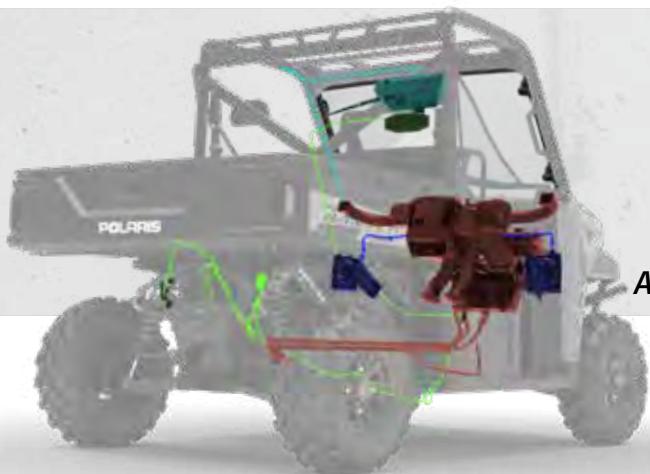

STEP 1

ADD A BATTERY CONNECTION CABLE

	3-SEAT	CREW
⚠ Battery Connection Cable	2879388 \$44 ⁹⁹	2879685 \$74 ⁹⁹

STEP 2 ADD ACCESSORIES

POWER WINDOW DOORS

	3-SEAT	CREW
Power Window Doors - Poly - Black	2880503 \$3,469 ⁹⁹	2880503 \$3,469 ⁹⁹

WINDSHIELD WIPER & WASHER SYSTEM

	3-SEAT	CREW
Windshield Wiper & Washer System	2879754 \$669 ⁹⁹	2879754 \$669 ⁹⁹

HEATER & DEFROST SYSTEM

	3-SEAT	CREW
8-Vent Heater & Defrost System	2880023 \$1,029 ⁹⁹	2880023 \$1,029 ⁹⁹

AUDIO: DASH RADIO

	3-SEAT	CREW
Bluetooth®, Apple® Control, AM/FM Dash Stereo & 2 x 5.25" Speakers by MB Quart®	2882030 \$809 ⁹⁹	2882030 \$809 ⁹⁹

DOOR LIGHT

	3-SEAT	CREW
Dome Light	2879270 \$99 ⁹⁹	2879270 \$99 ⁹⁹

GARAGE DOOR OPENER

	3-SEAT	CREW
Polaris® Remote Garage Door Opener by Homelink®	2882082 \$209 ⁹⁹	2882082 \$209 ⁹⁹

REAR VIEW CAMERA MIRROR

	3-SEAT	CREW
Rear View Camera Mirror	2881483 \$469 ⁹⁹	2881483 \$469 ⁹⁹

STEP 3

CONCEAL WIRING FOR A FINISHED, COMFORTABLE LOOK

	3-SEAT	CREW
Premium Roof Liner	2882914 \$269 ⁹⁹	2883457 \$339 ⁹⁹

BLUETOOTH®, APPLE® CONTROL, AM/FM DASH STEREO & 2 X 5.25" SPEAKERS BY MB QUART®

- All-in-one solution for giving your vehicle a performance-ready sound system
- AM/FM tuner with external antenna for reliable reception
- Powerful 45-watt x 4 channel amplifier
- Two off-road grade 5.25" speakers
- USB input and Bluetooth® compatible for wireless streaming
- System mounts into pre-designated mounting locations in the vehicle dash
- Easily add on other components to customize system

» 2882030 • \$809⁹⁹

XP 900 '13-19, CREW XP 900 '14-19, DIESEL '15-18, CREW DIESEL '15-18

⚠ Requires Battery Connection Cable

POLARIS® REMOTE GARAGE DOOR OPENER BY HOMELINK®

- HomeLink® technology allows you to control up to two garage doors

» 2882082 • \$209⁹⁹

XP 900 '13-19, CREW XP 900 '14-19, DIESEL '15-18, CREW DIESEL '15-18

⚠ Requires Battery Connection Cable



REAR VIEW CAMERA MIRROR

- Mirror automatically switches to a 4" back-up display when shifting to reverse

» 2881483 • \$469⁹⁹

XP 900 '13-19, CREW XP 900 '14-19, DIESEL '15-18, CREW DIESEL '15-18

⚠ Requires Battery Connection Cable

WATCH.



RECORD.



SHARE.



TO ADD LIGHTING, SEE WIRING INSTRUCTIONS ON P. 64

PRO ARMOR

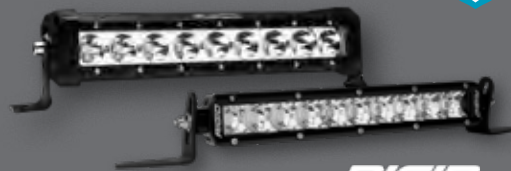

RIGID

RANGER® 570 FULL-SIZE

PERFORMANCE & COMFORT

THE RANGER® 570 FULL-SIZE builds on its legendary reputation for getting the job done. With the industry's most complete lineup of Polaris Engineered Accessories™, it's ready for anything your work demands.



ROOFS

ROOF/REAR PANEL

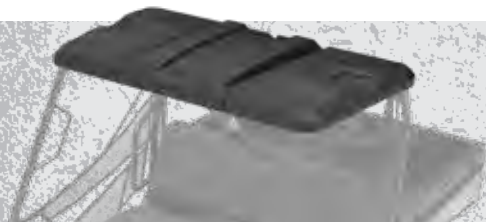

SPORT ROOF TOP SELLER

- Lightweight, rugged polyethylene construction
- Offers protection from sun and rain

» 2877946 • **\$409⁹⁹**
570 FULL-SIZE '16-19

» CREW • 2878755 • **\$669⁹⁹**
CREW 570 FULL-SIZE '16-19

BIMINI SOFT TOP

- Tight-fitting canvas soft top with easy on/off design
- Lightweight 600 denier, solution-dyed polyester construction

» 2876963-067 • **\$134⁹⁹**
570 FULL-SIZE '16-19

CANVAS ROOF/REAR PANEL

- Constructed from premium, mold-resistant polyester with UV stabilizers
- Durable, heat-sealed vinyl window for crack resistance

» 2883471 • **\$469⁹⁹**
570 FULL-SIZE '16-19

» 2877833-067 • **\$739⁹⁹**
CREW 570 FULL-SIZE '16-19

WINDSHIELDS

REAR PANEL



POLY WINDSHIELD

- Optical-grade, .236"-thick polycarbonate for outstanding protection and visibility

» HARD COAT • 2879489 • **\$669⁹⁹**
570 FULL-SIZE '16-19, CREW 570 FULL-SIZE '16-19

» GENERAL PURPOSE • 2876958 • **\$539⁹⁹**
570 FULL-SIZE '16-19, CREW 570 FULL-SIZE '16-19

HALF WINDSHIELD

- Durable, optical-grade .177"-thick polycarbonate for impact-resistance
- Half-height design delivers improved airflow for hot/dusty conditions
- Retains sporty, rugged look

» 2878756 • **\$269⁹⁹**
570 FULL-SIZE '16-19, CREW 570 FULL-SIZE '16-19

POLY REAR PANEL

- Constructed from thick, impact resistant polycarbonate
- Scratch-resistant for years of clear vision
- Delivers protection from the elements and a quieter ride
- Contoured design eliminates perimeter framework for full rearward visibility

» 2878165 • **\$339⁹⁹**
570 FULL-SIZE '16-19, CREW 570 FULL-SIZE '16-19



RANGER® 570 FULL-SIZE BUILD THE RIGHT TOOL FOR THE JOB.

CAB COMFORT WITH THE RANGER® CAB SYSTEM

- Roof
- Roof/Rear Panel
- Windshield
- Rear Panel
- Doors

MAKE WORK EASIER WITH THE RIGHT TOOLS FOR THE JOB

- Polaris® Winches Pg 54
- Rigid® & Pro Armor® Lighting Pg 64
- Kolpin® & Polaris® Hunting Acces. Pg 76
- Cargo Bed Storage Options Pg 48
- GLACIER® Plow Systems Pg 58
- Pro Armor® Wheels & Tires Pg 66

THE RIGHT STUFF TO MAINTAIN YOUR RANGER®

- Oil & Lubricants Pg 94
- Maintenance Parts Pg 96

EVERYTHING YOU NEED TO GEAR UP FOR THE RIDE

- Apparel & Helmets Pg 108

DOORS

RANGER® CANVAS DOORS

- Constructed from premium, mold-resistant polyester with UV stabilizers
- Durable, heat-sealed vinyl window for crack resistance
- Zip-down windows for adjustable ventilation

» 2876962-067 • **\$609⁹⁹**
570 FULL-SIZE '16-19



PROTECTION



BRUSHGUARDS

- Provides frontal impact resistance and headlight protection
- Durable, scratch-resistant black powdercoated finish
- Can be used with accessory winch or plow system
- Does not interfere with rear cargo drop gate

» FRONT • 2881662
\$269⁹⁹

570 FULL-SIZE '16-19, CREW 570 FULL-SIZE '16-19

» REAR • 2881661
\$209⁹⁹



HORN

» 2875048 • **\$99⁹⁹**
570 FULL-SIZE '16-19

REVERSE BEEPER

» 2880173 • **\$269⁹⁹**
570 FULL-SIZE '16-19



BUILD YOUR OWN RANGER.®
POLARIS.COM/RANGER

LOCK & RIDE

ADD STORAGE TO YOUR RANGER® 570 **P. 48**

BUILT TO HAUL MORE

75+ COMBINATIONS TO MAKE IT YOUR OWN

With a full line of Lock & Ride® accessories, you can haul more and do more. Use the chart below to see what combinations work together.

POLARIS RANGER STORAGE MATRIX XP 1000 XP 900 570 FULL-SIZE		LOCK & RIDE Tip-Down Headache Rack	LOCK & RIDE CargoMax System	LOCK & RIDE Bed Extender/Divider	LOCK & RIDE Storage Box	LOCK & RIDE Bed Rails	LOCK & RIDE Tool Rack	LOCK & RIDE Cargo Bed Enclosure System	LOCK & RIDE Wire Spooler	LOCK & RIDE Chainsaw Mount	LOCK & RIDE 60 Gallon Boomless Utility Sprayer	Gear Vault	Cargo Bed Mat
		2881531	2882177	2882752	2883279	2881532	2881533	2881312	2882157	2879354	2879799	2882353	2881484
LOCK & RIDE	Tip-Down Headache Rack	2881531	✓	✓	✓	✓			✓	✓	✓	✓	✓
LOCK & RIDE	CargoMax System	2882177	2882177		✓ ²							✓	✓
LOCK & RIDE	Bed Extender/Divider	2882752	✓	2882752	✓		✓		✓	✓			✓
LOCK & RIDE	Storage Box	2883279	✓	✓ ¹	2883279	✓ ¹	✓		✓	✓			✓
LOCK & RIDE	Bed Rails	2881532	✓		✓	2881532	✓ ³					✓	✓
LOCK & RIDE	Tool Rack	2881533		✓	✓	✓ ³	2881533		✓	✓		✓	✓
LOCK & RIDE	Cargo Bed Enclosure	2881312						2881312				✓	✓
LOCK & RIDE	Wire Spooler	2882157	✓		✓	✓	✓		2882157	✓	✓	✓	✓
LOCK & RIDE	Chainsaw Mount	2879354	✓	✓	✓		✓		✓	2879354	✓	✓	✓
LOCK & RIDE	60 Gallon Boomless	2879799	✓						✓	✓	2879799		✓
	Gear Vault	2882353	✓	✓		✓	✓	✓	✓	✓		2882353	✓
	Cargo Bed Mat	2881484	✓	✓	✓	✓	✓	✓	✓	✓	✓	✓	2881484

¹ Storage box at front of cargo box if not used with Tip-down Headache Rack

² Storage box at front of cargo box

³ Tool Rack at front of cargo box

LOCK & RIDE

EXCLUSIVELY ON POLARIS® VEHICLES, LOCK & RIDE® ACCESSORIES LET YOU QUICKLY CHANGE FROM ONE TASK TO ANOTHER WITH HUNDREDS OF OPTIONS.

WITH THE FLIP OF A LEVER, LOCK & RIDE® PLUNGERS USE OUTWARD PRESSURE TO EXPAND FOR A SECURE FIT.



LOCK & RIDE

TIP-DOWN HEADACHE RACK

- Rack tips down for additional storage solutions with space below and multiple tie-down points
- Lightweight and heavy-duty rack protects the cab of your *RANGER*® and lets you haul even more

» 2881531 • \$469⁹⁹

XP 1000 '17-19, CREW XP 1000 '17-19, XP 900 '13-19, CREW XP 900 '14-19, DIESEL '15-18, CREW DIESEL '15-18, 570 FULL-SIZE '16-19, CREW 570 FULL-SIZE '16-19 (DOES NOT FIT HIGHLIFTER MODELS)



LOCK & RIDE

CARGOMAX SYSTEM

- Comes standard with a support bar that ties the two sides together for a sturdy cargo hold.
- Designed to attach to the Lock & Ride® Tip-Down Headache Rack for additional support and three-sided containment
- Adjustable utility hooks provide more options for hanging tools, cords or gear

» 2882177 • \$669⁹⁹

XP 1000 '17-19, CREW XP 1000 '17-19, XP 900 '13-19, CREW XP 900 '14-19, DIESEL '15-18, CREW DIESEL '15-18, 570 FULL-SIZE '16-19, CREW 570 FULL-SIZE '16-19



LOCK & RIDE

BED RAILS

- Heavy-duty steel construction with a rugged powder-coat finish
- Features several additional tie-down points for load securing options

» 2881532 • \$169⁹⁹

XP 1000 '17-19, CREW XP 1000 '17-19, XP 900 '13-19, CREW XP 900 '14-19, DIESEL '15-18, CREW DIESEL '15-18, 570 FULL-SIZE '16-19, CREW 570 FULL-SIZE '16-19



LOCK & RIDE

BED EXTENDER/DIVIDER

- Extend or divide the cargo box
- Installs in any location in the box
- Multiple tie-down points available to secure cargo

» 2882752 • \$269⁹⁹

XP 1000 '18-19, CREW XP 1000 '19

» 2879117 • \$269⁹⁹

CREW XP 1000 '17-18, XP 900 '13-19, CREW XP 900 '14-19, DIESEL '14-18-18, CREW 570 FULL-SIZE '17-19



FRONT HOOD STORAGE RACK

- Front curve helps keep cargo in place when traveling
- Provides additional protection
- Fully integrated pivots to gain under-hood access

» 2882690 • \$469⁹⁹

XP 1000 '18-19, CREW XP 1000 '19

» 2881459 • \$469⁹⁹

CREW XP 1000 '17-18, XP 900 '13-19, CREW XP 900 '14-19, DIESEL '15-18, CREW DIESEL '15-18

LOCK & RIDE

QUICKSTRAP

- The Quickest and Most Secure Way to Mount Polaris® Accessories
- Sold as a pair

» 2882187 • \$59⁹⁹

ALL COOLERS, *RANGER*® CARGO BOXES

LOCK & RIDE

D-RINGS

- The most versatile Lock & Ride® accessory - add as many as you need to secure your cargo with bungee cords or straps

» 2881545 • \$43⁹⁹

ALL *RANGER*® CARGO BOXES

NEW

1.5" X 15' 5,500 LB RATCHET STRAP

- Heavy duty webbing
- 5,500 Lb. Maximum Load / 1,833 Lb. Working Load
- 2 Pack

» 2884031 • \$59⁹⁹

NEW

2" X 20' 10,000 LB RATCHET STRAP

- Heavy duty webbing
- 10,000 Lb. Maximum Load / 3,300 Lb. Working Load
- Floating D-Rings
- Double J-Hooks

» 2884032 • \$43⁹⁹



THE RIGHT TOOL FOR THE JOB

LOCK & RIDE

CHAINSAW MOUNT

- Can be secured to the outside of the bed wall so your chainsaw is within reach at all times

» 2879354 • \$179⁹⁹

XP 1000 '17-19, CREW XP 1000 '17-19,
XP 900 '13-19, CREW XP 900 '14-19,
DIESEL '15-18, CREW DIESEL '15-18,
570 FULL-SIZE '16-19, CREW 570 FULL-SIZE '16-19



LOCK & RIDE

BOOMLESS UTILITY SPRAYER - 60 GALLON

» 2879799 • \$1,209⁹⁹

XP 1000 '17-19, CREW XP 1000 '17-19,
XP 900 '13-19, CREW XP 900 '14-19,
DIESEL '15-18, CREW DIESEL '15-18,
570 FULL-SIZE '16-19, CREW 570 FULL-SIZE '16-19

BED ESSENTIALS

CARGO BOX LIFT

» 2882895 • \$809⁹⁹

XP 1000 '18-19, CREW XP 1000 '19

» 2882291 • \$809⁹⁹

CREW XP 1000 '17-18,
XP 900 '13-19,
CREW XP 900 '14-19



CARGO BED MAT

- Non-slip surface to better secure loads & keep cargo bed clean

» 2882751 • \$179⁹⁹

XP 1000 '18-19, CREW XP 1000 '19

» 2881484 • \$179⁹⁹

CREW XP 1000 '17-18, XP 900 '13-19,
CREW XP 900 '14-19, DIESEL '15-18,
CREW DIESEL '15-18, 570 FULL-SIZE '16-19,
CREW 570 FULL-SIZE '16-19



FIRE EXTINGUISHER HOLDER

- Only holds a 3.25" diameter extinguisher
- Quick release strap allows for easy use

» 2882158 • \$114⁹⁹

XP 1000 '17-19, CREW XP 1000 '17-19,
XP 900 '13-19, CREW XP 900 '14-19,
DIESEL '15-18, CREW DIESEL '15-18,
570 FULL-SIZE '16-19, CREW 570 FULL-SIZE '16-19



RIDE & REPAIR ESSENTIALS KIT

» 2881207 • \$134⁹⁹



TASK-SPECIFIC TOOLS



LOCK & RIDE TOOL RACK

- Attach on the inside or outside of the cargo bed

» 2881533 • \$269⁹⁹

XP 1000 '17-19, CREW XP 1000 '17-19,
XP 900 '13-19, CREW XP 900 '14-19,
DIESEL '15-18, CREW DIESEL '15-18,
570 FULL-SIZE '16-19, CREW 570 FULL-SIZE '16-19



LOCK & RIDE SPARE TIRE MOUNT

- Be ready for an unexpected flat with a spare that's conveniently along for the ride

» 2881529 • \$269⁹⁹

XP 1000 '17-19, CREW XP 1000 '17-19,
XP 900 '13-19, CREW XP 900 '14-19,
DIESEL '15-18, CREW DIESEL '15-18,
570 FULL-SIZE '16-19, CREW 570 FULL-SIZE '16-19



LOCK & RIDE WIRE SPOOLER

- Designed for a variety of wire spool sizes, does not work with barbed wire due to size of spools
- Manual crank or accepts cordless drill
- Mount post for hydraulic or manual fence post driver

» 2883280 • \$409⁹⁹

XP 1000 '17-19, CREW XP 1000 '17-19,
XP 900 '13-19, CREW XP 900 '14-19,
DIESEL '15-18, CREW DIESEL '15-18,
570 FULL-SIZE '16-19, CREW 570 FULL-SIZE '16-19

ORGANIZE & PROTECT



LOCK & RIDE CARGO BED ENCLOSURE SYSTEM

- Haul more with your *RANGER* and keep your items or gear protected from the elements
- Builds with Lock & Ride® anchors so it can store flat when not in use
- Top can be used as a tonneau cover

» 2881312 • \$1,209⁹⁹

XP 1000 '17-19, CREW XP 1000 '17-19,
XP 900 '13-19, CREW XP 900 '14-19,
DIESEL '15-18, CREW DIESEL '15-18,
570 FULL-SIZE '16-19, CREW 570 FULL-SIZE '16-19
(DOES NOT FIT HIGHLIFTER MODELS)



LOCK & RIDE STORAGE BOX

- Enough room to store all the tools you need to get the job done
- Internal organizational dividers keep gear from rolling around
- Easily detaches from vehicle

» 2883279 • \$439⁹⁹

XP 1000 '17-19, CREW XP 1000 '17-19,
XP 900 '13-19, CREW XP 900 '14-19,
DIESEL '15-18, CREW DIESEL '15-18,
570 FULL-SIZE '16-19, CREW 570 FULL-SIZE '16-19



RANGER® GEAR VAULT

- Designed for a perfect fit in the cargo bed for the Full-Size *RANGER*, can also be used in other trucks
- Water-resistant design, with two easy-to-pull handles with locking middle handle and two adjustable dividers to meet your hauling needs
- Integrated top depressions allow for an exact fit for the Lock & Ride® Dog Kennel, Polaris Northstar® Coolers (30 & 60 qt.), 5-gallon buckets and more

» 2882353 • \$869⁹⁹

XP 1000 '17-19, CREW XP 1000 '17-19,
XP 900 '13-19, CREW XP 900 '14-19,
DIESEL '15-18, CREW DIESEL '15-18,
570 FULL-SIZE '16-19, CREW 570 FULL-SIZE '16-19

TOW & HAUL



TRAILER BALLS

- » 2" WITH 3/4" SHANK
2877603 • \$18⁹⁹
- » 1 7/8" WITH 3/4" SHANK
2877602 • \$18⁹⁹



2" BALL MOUNT

- » 2" RECEIVER
2875320 • \$59⁹⁹



3:1 HITCHES **NEW**

- » 2" X 2" RECEIVER
2830522 • \$47⁹⁹
- » 1 3/4" X 1 3/4" RECEIVER
2830523 • \$47⁹⁹
- » 1 7/8" REPLACEMENT BALL
2830524 • \$11⁹⁹

ALL RANGER® MODELS

FRONT MOUNT RECEIVER HITCH

- Standard 2" receiver mount bolts directly to the frame
- UTV attachment works with Polaris® bumpers
- Rated at 100 lb tongue weight and 1000 lb towing

- » 2882782 • \$169⁹⁹
XP 1000 '18-19, CREW XP 1000 '19
- » 2878846 • \$169⁹⁹
CREW XP 1000 '17-18, XP 900 '13-19, CREW XP 900 '14-19, DIESEL '15-18, CREW DIESEL '15-18



3-SEAT & CREW

XP 1000 / XP 900
570 FULL-SIZE

ROOFS

GLASS WINDSHIELDS
& REAR PANELS

POLY WINDSHIELDS
& REAR PANELS

DOORS

CAB COMFORT

AUDIO

STORAGE &
PROTECTION

PROTECT YOUR INVESTMENT

THE BEST WAY TO PROTECT your *RANGER*® is with durable, rugged Polaris® brushguards and guards. Engineered for heavy-duty use, these items are your best line of defense against unexpected encounters, and will keep you going strong even when on the toughest job.



STANDARD BRUSHGUARDS

PERFECT FOR: **INCREASED PROTECTION AROUND LIGHTING AND FENDERS**

FRONT



INSTALLS DIRECTLY TO STOCK BUMPER



1 3/4" DIAMETER
STEEL TUBE CONSTRUCTION



INSTALLS DIRECTLY TO STOCK BUMPER



1 3/4" DIAMETER
STEEL TUBE CONSTRUCTION

REAR



CAN BE USED IN CONJUNCTION WITH A TOW HITCH



POLARIS

» FRONT • 2882531 • **\$339⁹⁹**

» REAR • 2882529 • **\$269⁹⁹**

XP 1000 '18-19, CREW XP 1000 '19
FRONT BRUSHGUARD DOES NOT FIT HIGHLIFTER MODELS

» FRONT • 2878839 • **\$339⁹⁹**

» REAR • 2878840 • **\$269⁹⁹**

CREW XP 1000 '17-18, XP 900 '13-19, CREW XP 900 '14-19, DIESEL '15-18, CREW DIESEL '15-18
FRONT BRUSHGUARD DOES NOT FIT HIGHLIFTER MODELS

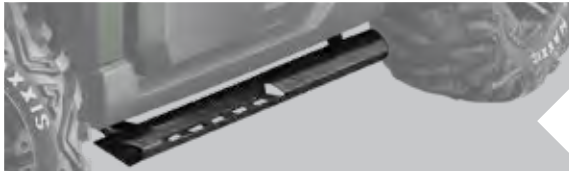

ROCK GUARD WITH STEP **NEW**

- Reliable, hard-working protection for edges of vehicle
- Integrated step with boot scraper
- Mounts directly to the frame, instead of underneath, for maximum ground clearance
- Steel construction
- Black e-coat and durable black powdercoated finish

» 3-SEAT • 2882530 • **\$269⁹⁹**

XP 1000 '18-19

» CREW • 2883398 • **\$469⁹⁹**

CREW XP 1000 '19

XP ROCK GUARD WITH STEP

- Durable, stamped plate steel construction
- Provides additional protection to side of vehicle
- Integrated boot scraper helps keep interior clean

» 3-SEAT • 2878843 • **\$269⁹⁹**

XP 900 '13-19, DIESEL '15-18

» CREW • 2879622 • **\$469⁹⁹**

CREW XP 1000 '17-18, CREW XP 900 '14-19,
CREW DIESEL '15-18

EXTREME BRUSHGUARDS

PERFECT FOR: **MAXIMUM PROTECTION, INTEGRATED MOUNTING POINTS**

REPLACES STOCK BUMPER

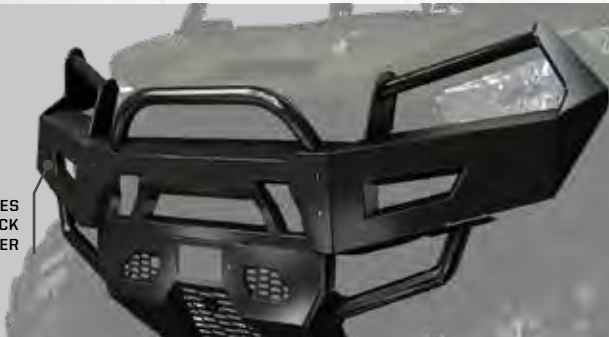

POLARIS



CONVENIENT STORAGE FOR TOWING OR TRAILERING ITEMS

» FRONT • 2879201 • **\$539⁹⁹**

CREW XP 1000 '17-18, XP 900 '13-19, CREW XP 900 '14-19,
DIESEL '15-18, CREW DIESEL '15-18

» REAR • 2878842 • **\$499⁹⁹**

HMW SKID PLATE

- Strong, 3/4" thick lightweight HMW (high molecular weight) polyethylene construction withstands off-road impacts, protecting vehicle components
- Molded specifically for the *RANGER XP* underbody for sure fit & low-profile presence
- Bolts quickly & easily into designated, integrated installation locations

» 2879686 • **\$269⁹⁹**

XP 900 '13-19, DIESEL '15-18

HMW A-ARM GUARDS

- Strong, 3/4" thick, durable, lightweight HMW (high molecular weight) polyethylene construction helps protect against off-road impacts
- Molded specifically for the *RANGER XP* front suspension for a sure fit & low-profile presence
- Easy bolt-on design with mounting hardware included

» FRONT • 2882784 • **\$269⁹⁹**

XP 1000 '18-19, CREW XP 1000 '19

» REAR • 2882787 • **\$269⁹⁹**

XP 1000 '18-19, CREW XP 1000 '19

» FRONT • 2880553 • **\$269⁹⁹**

CREW XP 1000 '17-18,
XP 900 '13-19, CREW XP 900 '14-19,
DIESEL '15-18, CREW DIESEL '15-18

» REAR • 2880554 • **\$269⁹⁹**

CREW XP 1000 '17-18,
XP 900 '13-19, CREW XP 900 '14-19,
DIESEL '15-18, CREW DIESEL '15-18

RANGER XP 900 SHOWN

TOUGH. DEPENDABLE. BUILT FOR THE OFF-ROAD.



WARRANTY

PRO PRO HEAVY DUTY SERIES

I-HID HEAVY DUTY SERIES

WINCH TYPES



RAPID ROPE RECOVERY	STANDARD	NOT AVAILABLE
AUTO STOP TECHNOLOGY	STANDARD	OPTION
SYNTHETIC ROPE	STANDARD	OPTION
FAIRLEAD	ALUMINUM	STEEL ROLLER
WIRELESS REMOTE	STANDARD	OPTION
WIRED REMOTE	OPTION	STANDARD
WINCHES AVAILABLE	6,000 LB. & 4,500 LB.	4,500 LB. & 3,500 LB.

PRO

PRO HEAVY DUTY SERIES

PREMIUM FEATURES FOR TOP-OF-THE-LINE POWER

INDUSTRY 1ST TECHNOLOGY

RAPID ROPE RECOVERY

5X
FASTER

RAPID ROPE RECOVERY

1. Set Winch Dial to FREE SPOOL (N) to attach Winch Hook
2. Set Winch Dial to PULL (L) for Winch Mode
3. Set Winch Dial to ROPE RECOVERY (H) for 5x Faster Rope Recovery

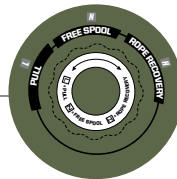

CUT STEEL GEARS & SEALED DRIVETRAIN

INTEGRATED WIRING INCLUDED

SEALED PERMANENT MAGNET MOTOR



AUTO STOP TECHNOLOGY

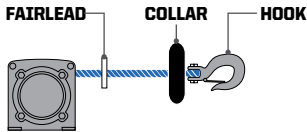

Winch stops when fairlead detects collar

Auto Stop Technology stops winch at end of pull to prevent driveline stress and plow overlifting

PREMIUM SYNTHETIC ROPE

- Lightweight & Easy to Handle
- Superior Flexibility
- Greater Strength than Steel Cable
- 50ft Long



HOOK WITH STRAP

WIRELESS REMOTE



50 Ft. range wireless remote control with unique code for interference-free operation

PREASSEMBLED



Winch ready to install out of the box. Attached to mount and pre-wired.

Offered on RANGER XP[®] 1000 MY18-19, and RANGER CREW[®] XP 1000 MY19.



H-D

HEAVY DUTY SERIES

PULLING POWER FOR EVERYDAY USE & PERFORMANCE

INTEGRATED WIRING INCLUDED

SEALED PERMANENT MAGNET MOTOR

INTEGRATED WIRED REMOTE

50 FT STEEL CABLE

HOOK WITH STRAP



MOUNT INCLUDED

CUT STEEL GEARS & SEALED DRIVETRAIN

STEEL ROLLER FAIRLEAD

THERE'S A REASON THESE ARE THE BEST WINCHES ON THE MARKET.

Polaris[®] winches are fully sealed to keep out water, dust and other debris.



✓ TESTED **1,200+** PULLS AT MAX LOAD, IT WORKS WHEN YOU NEED IT TO



✓ SEALED MOTOR & HEAVY DUTY GEARS OPERATE FULLY SUBMERGED UNDERWATER



✓ BUILT TO WITHSTAND **-20° F** TEMPERATURES



✓ **MILITARY** TESTED & APPROVED

COMMON

3-SEAT 6-BREW / 2-SEAT 6-BREW

WINCH

PLOWS

LIGHTING

WHEELS & TIRES

COOLERS

HUNT

FISH / YOUTH

PRO

PRO HEAVY DUTY SERIES

PREMIUM FEATURES FOR TOP-OF-THE-LINE POWER



INDUSTRY

NEW TECHNOLOGY

RAPID ROPE RECOVERY

5x FASTER

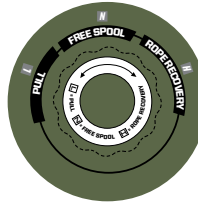

RAPID ROPE RECOVERY

1. Set Winch Dial to FREE SPOOL (N) to attach Winch Hook
2. Set Winch Dial to PULL (L) for Winch Mode
3. Set Winch Dial to ROPE RECOVERY (H) for 5x Faster Rope Recovery

PREASSEMBLED

Winch ready to install out of the box. Attached to mount and pre-wired.

Offered on RANGER XP® 1000 MY18-19, and RANGER CREW® XP 1000 MY19.

WIRELESS REMOTE

50 Ft. range wireless remote control with unique code for interference-free operation

PREMIUM SYNTHETIC ROPE

- Lightweight & Easy to Handle
- Superior Flexibility
- Greater Strength than Steel Cable
- 50ft Long

AUTO STOP TECHNOLOGY

Auto Stop Technology stops winch at end of pull to prevent driveline stress and plow overlifting

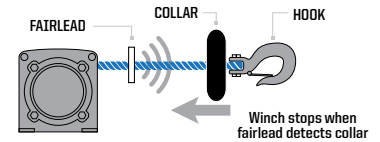

3 STEPS FOR ADDING A WINCH:

1 FIND YOUR MACHINE

2 CHOOSE BETWEEN POLARIS® PRO HD



		PRO PRO HEAVY DUTY SERIES	
MODEL		6,000 LB. WINCH SERIES	4,500 LB. WINCH SERIES
3-SEAT & CREW	XP 1000 '18-19 CREW XP 1000 '19	2882710 \$1,229.99	TOP SELLER 2882711 \$1,099.99
	CREW XP 1000 '17-18 XP 900 '13-19 CREW XP 900 '14-19 DIESEL '15-18 CREW DIESEL '15-18	2882237 \$1,229.99	TOP SELLER 2882236 \$1,099.99
	570 FULL SIZE '16-19 CREW 570 FULL-SIZE '16-19		2882238 \$1,099.99
2-SEAT & CREW	570 '15-19 CREW 570-4 '15-19 500 '17-19		2882238 \$1,099.99

H-D HEAVY DUTY SERIES PULLING POWER FOR EVERYDAY USE & PERFORMANCE



- Cut steel gears for improved durability
- Steel spool can handle extreme loads
- 40% quieter – near-silent free spooling
- Sealed motor and drivetrain
- High-powered contactor
- Integrated wiring and mount plates ensure perfect fit

OR POLARIS® HD WINCH 3 ADD CABLES

H-D HEAVY DUTY SERIES		REQUIRED BATTERY CONNECTION CABLES
4,500 LB. WINCH SERIES	3,500 LB. WINCH SERIES	
2882714 \$809 ⁹⁹		STANDARD ON ALL MODELS
<small>TOP SELLER</small> 2881667 \$809 ⁹⁹		<i>3-Seat Models:</i> 2879388 \$44 ⁹⁹ <i>Crew Models:</i> 2879685 \$74 ⁹⁹
	<small>TOP SELLER</small> 2881669 \$609 ⁹⁹	<i>3-Seat Models:</i> 2879388 \$44 ⁹⁹ <i>Crew Models:</i> 2879685 \$74 ⁹⁹
	<small>TOP SELLER</small> 2881669 \$609 ⁹⁹	<i>2-Seat Models:</i> 2879990 \$44 ⁹⁹ <i>Crew Models:</i> 2880929 \$74 ⁹⁹

UPGRADE YOUR POLARIS® HD WINCH WITH THESE ACCESSORIES

POLARIS® WIRELESS WINCH REMOTE

- Allows for remote operation of Polaris® HD winch
 - Up to 50' range with LED indicator
 - Direct plug and play operation
- » **2879316 • \$179⁹⁹**
Works with 2881667, 2881669
- » **2883455 • \$179⁹⁹**
Works with Polaris® HD 4,500 Lb. Winch 2882714

POWER CONTROLLER

- Control your winch and plow hydraulics directly from the shift knob
 - Ideal for plowing; lift and angle directly at your fingertips
- » **2883247 • \$269⁹⁹**
XP 1000 '18-19, CREW XP 1000 '19
CONTROLS HYDRAULICS, DOES NOT CONTROL WINCH
- » **2879227 • \$59⁹⁹**
CREW XP 1000 '17-18, XP 900 '13-19,
CREW XP 900 '14-19, DIESEL '14-18-18,
570 FULL-SIZE '17-19, 570 '14-19,
CREW 570-4 '14-19, 500 '11-19, EV '11-19,
EV LI-ION '18

AUTO STOP TECHNOLOGY WINCH UPGRADE

- Machined from billet aluminum and weighs less than common steel fairleads
 - Installs easily in place of stock fairlead
 - Requires synthetic winch rope (not included) (not compatible with steel cable)
- » **2883454 • \$129⁹⁹**
Works with Polaris® HD 4,500 Lb. Winch 2882714
- » **2881692 • \$134⁹⁹**
Works with Polaris® HD 4,500 Lb. Winch 2881667
- » **2881693 • \$134⁹⁹**
Works with Polaris® HD 3,500 Lb. Winch 2881669

POLARIS® WIRED WINCH REMOTE CONTROL

- Must order remote handle and socket together.
- » **REMOTE HANDLE • 4013466 • \$75⁹⁹**
Works with all models
- » **SOCKET • 4017102 • \$47⁹⁹**
XP 1000 '18-19, CREW XP 1000 '19
- » **SOCKET • 4014228 • \$47⁹⁹**
All RANGER® Models Except those listed for 4017102

SYNTHETIC WINCH ROPE

- 6,000 LB.
» **2879188 • \$229⁹⁹**
- 4,500 LB.
» **2879187 • \$179⁹⁹**
- 3,500 LB. (with Hook)
» **2878888 • \$104⁹⁹ NEW**



COMMON
3-SEAT & CREW / 2-SEAT & CREW
WINCH
PLOW
LIGHTING
WHEELS & TIRES
COOLERS
HUNT
FISH / YOUTH



PLOW SYSTEM

EASILY CONQUER WINTER'S WORST

Install a Polaris® Glacier® plow system and move some serious snow when winter's wrath comes calling. Only with a Glacier® plow do you get drive up and plow capability with simple Lock & Ride® installation and removal. Choose from the unbeatable capability of the top-of-the-line Glacier® Pro HD, or get amazing performance and value with the Glacier® HD.



View this RANGER® & make it your own
POLARIS.COM/RANGERprohd1000

RANGER XP® 1000 EPS
Steel Blue

THE POLARIS ENGINEERED™ ADVANTAGE

LOCK & RIDE

INSTALLATION

With the integrated Lock & Ride® attachment points, you can easily drive up to the plow frame, attach and be plowing in moments.

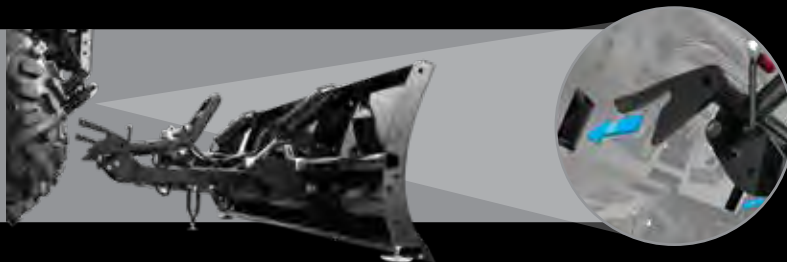

ROBUST PLOW FRAME

Constructed of heavy-duty steel with e-coated rust protection, giving you a durable system you can rely on season after season.



SHEAR PIN PROTECTION

Engineered to protect your vehicle, shear pins act as a fail-safe point in the instance of accidental collision or over-exertion of the plow system.

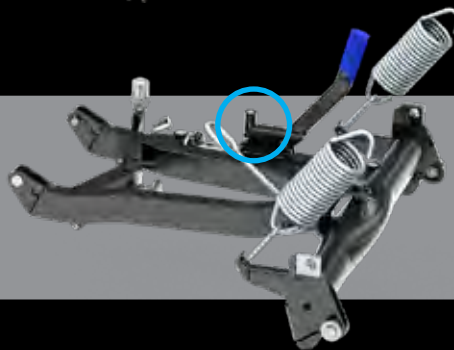

BLADE MATERIAL

Durable poly and steel blades are designed to push more. Choose a steel blade for longevity and increased rigidity or a lightweight non-stick, poly blade that's easier on plowing surfaces.

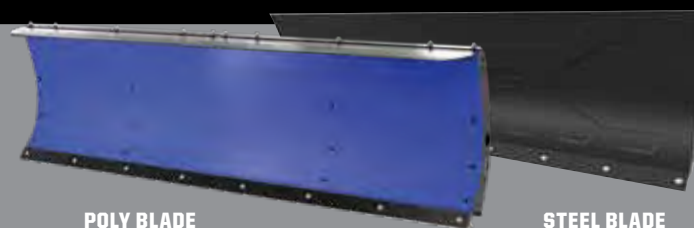

POLY BLADE

STEEL BLADE

CONVENIENT CONTROL

Lift and angle your blade right from the driver's seat with the addition of hydraulics on the Glacier® PRO HD Plow System.



ANGLE YOUR BLADE
RIGHT FROM YOUR SEAT
WITH THE GLACIER® PRO HD
PLOW SYSTEM HYDRAULIC
ANGLE SYSTEM

GLACIER[®] PRO HD

PLOW SYSTEM



HYDRAULIC CONTROL FOR EXTREME

SNOW REMOVAL

A robust frame and tough blades, combined with a convenient hydraulic angle system, allow your Glacier[®] Pro HD to move serious snow while you remain comfortable.

Thanks to Lock & Ride[®] technology, the Pro HD comes standard with a convenient kickstand attachment to the plow frame, giving you the easiest attachment.

View this RANGER[®] & make it your own
POLARIS.COM/RANGERprohd1000

RANGER XP[®] 1000 EPS
 Steel Blue

3-SEAT & CREW GLACIER[®] PRO HD » 72" Blades » Choice of poly or steel » Hydraulic lift & angle system option

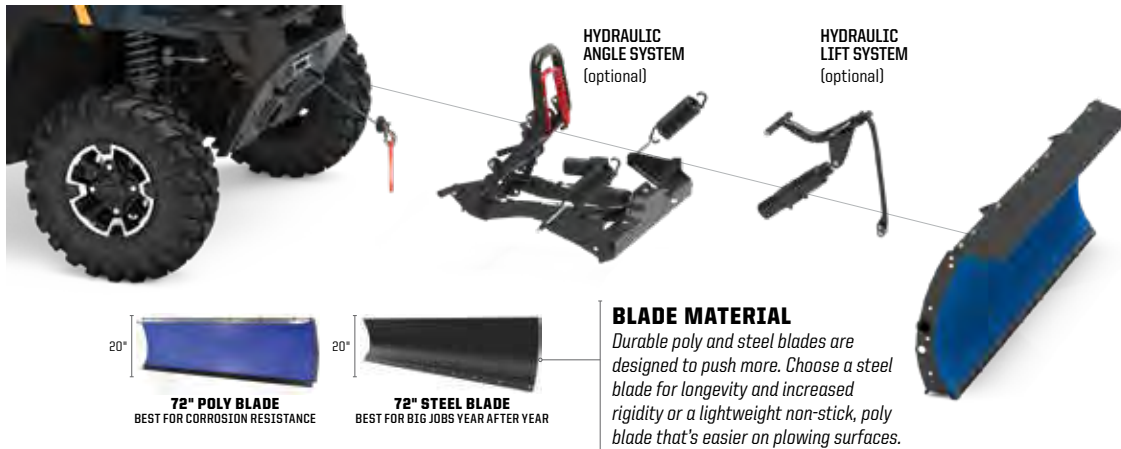

HYDRAULIC CONTROL FOR EXTREME SNOW REMOVAL

A robust frame and tough blades, combined with the option to add hydraulic controls, allow your Glacier[®] PRO HD to move serious snow while you remain comfortable. Thanks to Lock & Ride[®] technology, the PRO HD comes standard with a convenient kickstand attachment to the plow frame, giving you the easiest attachment.

BLADE MATERIAL

Durable poly and steel blades are designed to push more. Choose a steel blade for longevity and increased rigidity or a lightweight non-stick, poly blade that's easier on plowing surfaces.

	STEP 1 SELECT A MOUNT	STEP 2 SELECT A FRAME	STEP 3 SELECT PLOW CONFIGURATION	STEP 4 SELECT A BLADE	
MODELS	MOUNT	FRAME	HYDRAULICS	BLADES	
XP 1000 MY18-19 CREW XP 1000 MY19	Not Required Integrated into Factory Bumper	2883255 \$1,409 ⁹⁹ Track Extension 2879871 \$609 ⁹⁹ Plow Kickstand 2207382 \$30 ⁹⁹	Hydraulic Lift System 2883410 \$609 ⁹⁹ Hydraulic Angle System 2883409 \$669 ⁹⁹ Power Controller Required for hydraulic components 2883247 \$269 ⁹⁹	Polaris [®] PRO HD 6000 lb. Winch 2882710 \$1,229 ⁹⁹ Polaris [®] PRO HD 4500 lb. Winch 2882711 \$1,099 ⁹⁹	72" Poly 2879317 \$809 ⁹⁹ 72" Steel 2879874 \$609 ⁹⁹
XP 900 MY13-19 CREW XP 900 MY13-19 XP 1000 MY17 CREW XP 1000 MY17-18	2879106 \$209 ⁹⁹	Replacement Shear Pin 2204829 \$79 ⁹⁹	Hydraulic Lift System 2879220 \$669 ⁹⁹ Hydraulic Angle System 2879224 \$739 ⁹⁹ Power Controller Required for hydraulic components 2879227 \$59 ⁹⁹	Polaris [®] PRO HD 6000 lb. Winch 2882237 \$1,229 ⁹⁹ Polaris [®] PRO HD 4500 lb. Winch 2882236 \$1,099 ⁹⁹	72" Poly 2879317 \$809 ⁹⁹ 72" Steel 2879874 \$609 ⁹⁹

SELECT ACCESSORIES

PLOW BLADE SNOW DEFLECTOR

- » 72" • 2858541 • \$89⁹⁹
- » 66" • 2879866 • \$114⁹⁹
- » 60" • 2871808 • \$89⁹⁹

QUICK RELEASE SKID SHOES

- Helps prevent blade wear
- Hardened steel for industrial strength
- » PRO HD 2205071 • \$36⁹⁹

COIL SPRING SPACER

- Keep the front end of the vehicle up and improve ride quality when using a plow on strut or A-arm vehicles
- » 2872655 • \$24⁹⁹



LOCK & RIDE

DRIVE-UP. LINK UP.

The auto-retracting frame kickstand allows for convenient drive-in plow frame hook-up.

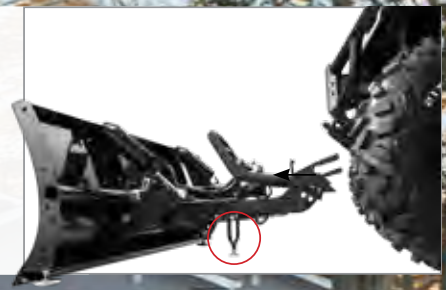

OPTIONAL HYDRAULIC CONTROL

Control the blade without leaving the comfort of your cab by adding hydraulic lift and angle systems exclusive to Glacier® Pro HD.



**2-SEAT & CREW
570 FULL-SIZE & CREW**

GLACIER® PRO HD

» 72" OR 66" Blades

» Choice of poly or steel

» Hydraulic angle system option

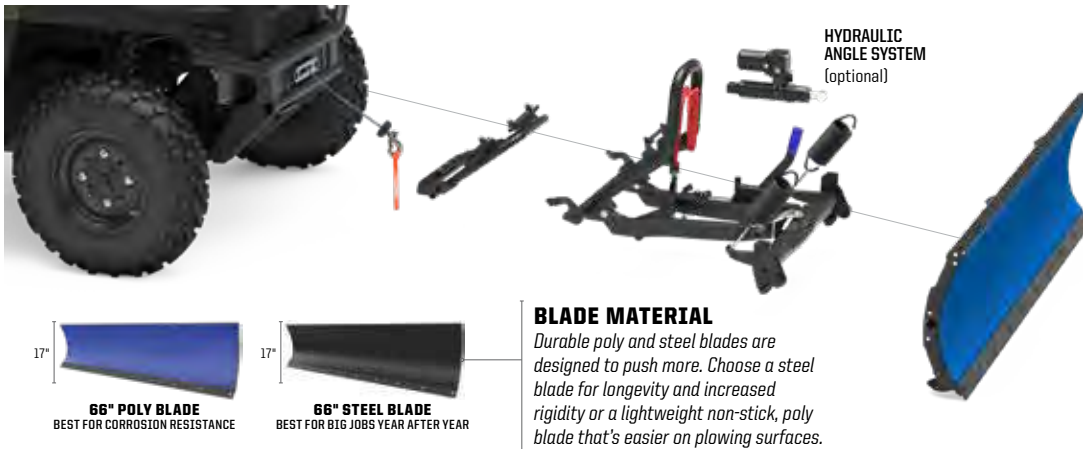

HYDRAULIC CONTROL FOR EXTREME SNOW REMOVAL

A robust frame and tough blades, combined with the option to add hydraulic controls, allow your Glacier® PRO HD to move serious snow while you remain comfortable. Thanks to Lock & Ride® technology, the PRO HD comes standard with a convenient kickstand attachment to the plow frame, giving you the easiest attachment.

BLADE MATERIAL

Durable poly and steel blades are designed to push more. Choose a steel blade for longevity and increased rigidity or a lightweight non-stick, poly blade that's easier on plowing surfaces.

	STEP 1 SELECT A MOUNT	STEP 2 SELECT A FRAME	STEP 3 SELECT PLOW CONFIGURATION		STEP 4 SELECT A BLADE
MODELS	MOUNT	FRAME	HYDRAULICS	WINCH	BLADES
570 FULL-SIZE MY16-19 CREW 570 FULL-SIZE MY16-19	2880261 \$339 ⁹⁹	2880260 \$609 ⁹⁹ Track Extension 2880267 \$339 ⁹⁹ Replacement Shear Pin 2205527 \$10 ⁹⁹	Hydraulic Angle System 2880266 \$809 ⁹⁹ Power Controller Required for hydraulic components 2879227 \$59 ⁹⁹	Polaris® PRO HD 4500 lb. Winch 2882238 \$1,099 ⁹⁹	72" Steel 2880270 \$609 ⁹⁹ 66" Poly 2880269 \$539 ⁹⁹ 66" Steel 2880268 \$469 ⁹⁹
570/500/ETX MY10-19 CREW 570 MY10-19 LI-ION EV & EV MY15-19	2880261 \$339 ⁹⁹		Hydraulic Angle System 2880266 \$809 ⁹⁹ Power Controller Required for hydraulic components 2879227 \$59 ⁹⁹	Polaris® PRO HD 4500 lb. Winch 2882238 \$1,099 ⁹⁹	72" Steel 2880270 \$609 ⁹⁹ 66" Poly 2880269 \$539 ⁹⁹ 66" Steel 2880268 \$469 ⁹⁹

WEAR BARS

- Protect your plow blade and minimize wear on the actual blade by installing Wear Bars
- » 72" • 2204976 • **\$74⁹⁹**
- » HD 72" • 2879875 • **\$139⁹⁹**
- » 66" • 2879867 • **\$74⁹⁹**
- » HD 66" • 2879868 • **\$134⁹⁹**
- » 60" • 2871806 • **\$59⁹⁹**

PLOW MARKER

- Helps driver monitor plow blade position
- Sold in pairs
- » 2872726 • **\$43⁹⁹**

PLOW LINK

- » 2204974 • **\$23⁹⁹**

COMMON

3-SEAT & CREW /
2-SEAT & CREW

WINCH

PLOWS

LIGHTING

WHEELS & TIRES

COOLERS

HUNT

FISH / YOUTH

GLACIER[®] HD

PLOW SYSTEM

MAKE QUICK WORK OF THE SMALLER JOBS

Move some snow with the robust and capable Glacier[®] HD plow system, and discover why a major snowfall can be the highlight of your week. With a robust frame, beefy poly and steel blade options, convenient Lock & Ride[®] mounting and dismounting and amazing value, Glacier[®] HD is a great choice in the dead of winter.



3-SEAT & CREW GLACIER[®] HD » **72" OR 66" Blades** » **Choice of poly or steel** » **Manual angle system standard**

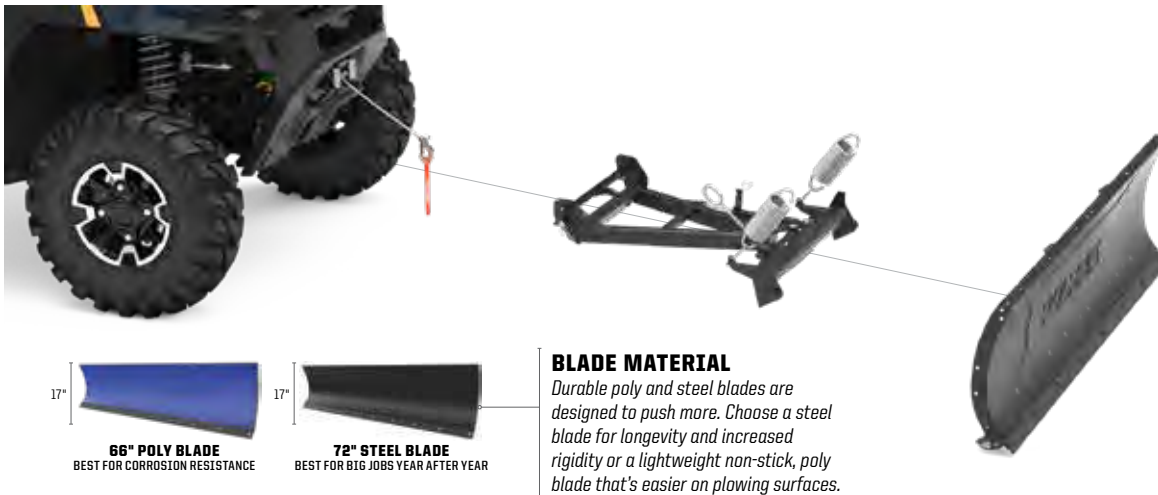

66" POLY BLADE
BEST FOR CORROSION RESISTANCE

72" STEEL BLADE
BEST FOR BIG JOBS YEAR AFTER YEAR

BLADE MATERIAL

Durable poly and steel blades are designed to push more. Choose a steel blade for longevity and increased rigidity or a lightweight non-stick, poly blade that's easier on plowing surfaces.

	STEP 1 SELECT A MOUNT	STEP 2 SELECT A FRAME	STEP 3 SELECT A LIFT METHOD	STEP 4 SELECT A BLADE
MODELS	MOUNT	FRAME	WINCHES	BLADES
XP 1000 MY18-19 CREW XP 1000 MY19	Not Required Integrated into Factory Brushguard	2882927 \$609 ⁹⁹ Replacement Shear Pin 2205527 \$10 ⁹⁹	Polaris[®] HD 4500 lb. Winch 2882714 \$809 ⁹⁹	72" Steel 2880270 \$609 ⁹⁹ 66" Poly 2880269 \$539 ⁹⁹ 66" Steel 2880268 \$469 ⁹⁹
XP 900 MY13-19 CREW XP 900 MY13-19 XP 1000 MY17 CREW XP 1000 MY17-18	2879106 \$209 ⁹⁹		Polaris[®] HD 4500 lb. Winch 2881667 \$809 ⁹⁹	72" Steel 2880270 \$609 ⁹⁹ 66" Poly 2880269 \$539 ⁹⁹ 66" Steel 2880268 \$469 ⁹⁹

SELECT ACCESSORIES

PLOW BLADE SNOW DEFLECTOR

- » 72" • 2858541 • \$89⁹⁹
- » 66" • 2879866 • \$114⁹⁹
- » 60" • 2871808 • \$89⁹⁹

QUICK RELEASE SKID SHOES

- Helps prevent blade wear
- Hardened steel for industrial strength
- » PRO HD 2205071 • \$36⁹⁹

COIL SPRING SPACER

- Keep the front end of the vehicle up and improve ride quality when using a plow on strut or A-arm vehicles
- » 2872655 • \$24⁹⁹



View this RANGER® & make it your own
POLARIS.COM/RANGERhd1000

RANGER XP® 1000 EPS
 Sage Green

2-SEAT & CREW 570 FULL-SIZE & CREW **GLACIER® HD** » 66" Blades » Choice of poly or steel » Hydraulic angle system option

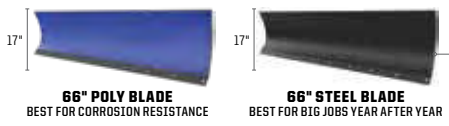
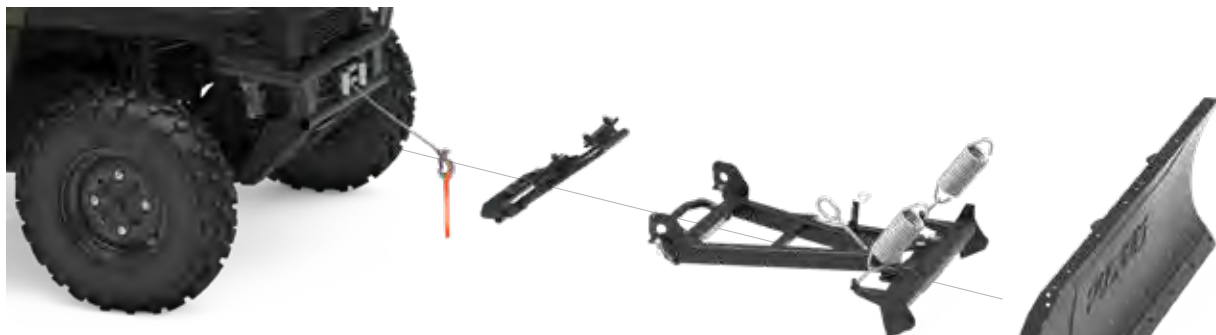

BLADE MATERIAL
 Durable poly and steel blades are designed to push more. Choose a steel blade for longevity and increased rigidity or a lightweight non-stick, poly blade that's easier on plowing surfaces.

	STEP 1 SELECT A MOUNT	STEP 2 SELECT A FRAME	STEP 3 SELECT A LIFT METHOD	STEP 4 SELECT A BLADE
MODELS	MOUNT	FRAME	WINCHES	BLADES
570 FULL-SIZE MY16-19 CREW 570 FULL-SIZE MY16-19	2879105 \$209 ⁹⁹	2882927 \$609 ⁹⁹ Replacement Shear Pin 2205527 \$10 ⁹⁹	Polaris® HD 3500 lb. Winch 2881669 \$609 ⁹⁹	66" Poly 2880269 \$539 ⁹⁹ 66" Steel 2880268 \$469 ⁹⁹
570/500/ETX MY10-19 CREW 570 MY10-19 LI-ION EV & EV MY15-19	2879105 \$209 ⁹⁹		Polaris® HD 3500 lb. Winch 2881669 \$609 ⁹⁹	66" Poly 2880269 \$539 ⁹⁹ 66" Steel 2880268 \$469 ⁹⁹

WEAR BARS

- Protect your plow blade and minimize wear on the actual blade by installing Wear Bars
- » 72" • 2204976 • \$74⁹⁹
- » HD 72" • 2879875 • \$139⁹⁹
- » 66" • 2879867 • \$74⁹⁹
- » HD 66" • 2879868 • \$134⁹⁹
- » 60" • 2871806 • \$59⁹⁹

PLOW MARKER

- Helps driver monitor plow blade position
- Sold in pairs
- » 2872726 • \$43⁹⁹

PLOW LINK

- » 2204974 • \$23⁹⁹

COMMON
 3-SEAT & CREW / 2-SEAT & CREW
 WINCH
 PLOWS
 LIGHTING
 WHEELS & TIRES
 COOLERS
 HUNT
 FISH / YOUTH

RIGID

POLARIS ENGINEERED™ ADVANTAGES

• **DESIGNED**
to mount perfectly to your Polaris Engineered™ bumper, roof or other mounting point

ADVANCED TECH

RIGID® lights are driven by Aluminum PCB Smart Boards™. 6063-T5 aircraft aluminum extruded housings and Tiger Drylac® UV protection polyester powdercoating.

EXCLUSIVE OPTICS

RIGID® lights feature impact-resistant polycarbonate lenses for a 100% water/dustproof seal.

RIGID® LIMITED LIFETIME WARRANTY*

If you own a RIGID® light and it breaks, we will replace or repair it for life.*

LIGHT BAR TYPES



SR-SERIES PRO

Sleek, powerful, low-profile (under 2" tall). Lights extreme distances with low energy usage.
Available in 10" & 32"



D-SERIES PRO

Compact to fit almost anywhere with high output and low energy usage.
Available in Driving, Flood & Spot

SEE THE RIGID® LIGHTING BUYERS GUIDE AT [YOUTUBE.COM/USER/POLARISORV](https://www.youtube.com/user/polarisorv) SEARCH "RIGID"



LIGHT BAR OPTIONS

OPTICS	DRIVING	FLOOD					SPOT		
1200 M									
960 M									
720 M									
480 M									
240 M									
BRAND SIZE TYPE	RIGID® POD D-SERIES	RIGID® 10" SR-SERIES	RIGID® 10" POD D-SERIES	PRO ARMOR® 10" DUAL-ROW	PRO ARMOR® 11" SINGLE-ROW	PRO ARMOR® 11" CUBE DUAL-ROW	RIGID® 10" SR-SERIES	RIGID® 10" POD D-SERIES	PRO ARMOR® 11" CUBE DUAL-ROW
RAW LUMENS	4,752	7,920	3,168	3,780	1,890	1,400	7,920	3,168	1,400
PN PRICE	2883128 • \$454 ⁹⁹ Comes in a pair	2883122 • \$349 ⁹⁹	2883126 • \$224 ⁹⁹ Comes in a pair	2882311 • \$269 ⁹⁹	2882313 • \$179 ⁹⁹	2882312 • \$114 ⁹⁹	2883121 • \$349 ⁹⁹	2883127 • \$224 ⁹⁹ Comes in a pair	2882076 • \$114 ⁹⁹

BUILD YOUR VISION

Consider the Optics, Angle & how you will use your vehicle to choose the right light or set of lights.

OPTICS LIGHT ANGLE	ACCENT	DRIVING (45°)	FLOOD (25°)	SPOT (10°)	COMBO (25°/10°)
DRIVING SPEED	All	Slow	Medium	Fast	Medium to Fast
BEAM	Diffused glow	Extra-wide	Wide/Shorter	Concentrated/Long	Inner Spot & Outer Flood
RECOMMENDED MOUNTING	Low/Wheel well	All points	Low &/or rear	High points	All points
TERRAIN & RIDING STYLE	Added style & personalization in any terrain	All riding & utility	Wide-open terrain or trails & utility	Trail & tight conditions	All riding & utility

COMPARE LIGHTS IN A REAL WORLD SETTING AT [POLARIS.COM/LIGHTING](https://www.polaris.com/lighting)

* If RIGID® determines, in its sole discretion, that your product is defective in material or workmanship, RIGID® will honor your warranty claim. In some cases the product will be replaced, depending on the specific timeframe of the purchase. If the product is repaired, all parts, labor, and return shipping may be covered by RIGID®.

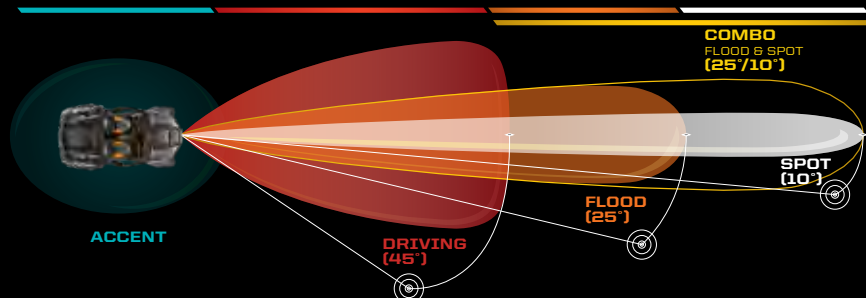

• **TESTED**
for maximum
performance

• **TRUSTED**
to not overtax
your machine

PRO ARMOR®



COMMON

3-SEAT & CREW /
2-SEAT & CREW

WINCH

PLOWS

LIGHTING

WHEELS & TIRES

COOLERS

HUNT

FISH / YOUTH

RUGGED CONSTRUCTION

Pro Armor® lights are designed to be big and beefy with an aggressive style all their own, and housed in IP67 marine-grade rated UV polyester powdercoating.

MASSIVELY BRIGHT

Pro Armor® builds bright lights designed for any riding experience. All that power is directed through heat dissipating aluminum for streamlined heat management.



DUAL-ROW LED LIGHT BARS

The most spread and farthest illumination downrange. Easy to mount.
Available in Cube, 10", 20" & 30"



SINGLE-ROW LED LIGHT BARS

Powerful, compact, low-profile light bars with sleek look.
Available in 11", 33" & 40"



CUBE LED LIGHTS

Small size allows mounting in strategic locations for added lighting.
Available in Flood & Spot

COMBO

OPTICS

1200 M
960 M
720 M
480 M
240 M



PRO ARMOR® 10" DUAL-ROW	PRO ARMOR® 11" SINGLE-ROW
3,780	1,890
2882075 • \$269 ⁹⁹	2882078 • \$209 ⁹⁹

RIGID® 32" SR-SERIES	RIGID® 10" SR-SERIES	PRO ARMOR® 30" DUAL-ROW	PRO ARMOR® 20" SINGLE-ROW	PRO ARMOR® 40" SINGLE-ROW	PRO ARMOR® 33" SINGLE-ROW
20,064	7,920	13,860	8,820	7,560	6,300
2883124 • \$1,024 ⁹⁹	2883123 • \$349 ⁹⁹	2882074 • \$649 ⁹⁹	2883107 • \$509 ⁹⁹	2882763 • \$649 ⁹⁹	2882077 • \$509 ⁹⁹

BRAND
SIZE
TYPE
RAW LUMENS
PN PRICE

ADD A HARNESS TO MOUNT YOUR LIGHTS

LIGHT BAR SET-UPS

MODEL	1 LIGHT IN 1 LOCATION ON 1 SWITCH	2 LIGHTS IN 2 LOCATIONS ON 1 SWITCH	2 LIGHTS IN 2 LOCATIONS ON 2 SWITCHES
2014-2019 ALL MODELS EXCEPT XP 1000 '18-19 & CREW XP 1000 '19	⚠ Requires Battery Connection Cable LIGHT BAR HARNESS 2882209 \$114 ⁹⁹	⚠ Requires Battery Connection Cable LIGHT BAR HARNESS 2882209 \$114 ⁹⁹ Y-HARNESS 2879860 \$23 ⁹⁹	⚠ Requires Battery Connection Cable LIGHT BAR HARNESS (x2) 2882209 \$114 ⁹⁹
XP 1000 '18-19, CREW '19	SEE PAGE 27 FOR  WIRING CONNECTIONS		

⚠ BATTERY CONNECTION CABLES

3-SEAT & CREW

- » 3-SEAT • 2879388 • \$44⁹⁹
XP 900 '13-19, DIESEL '15-18
- » CREW • 2879685 • \$74⁹⁹
CREW XP 1000 '17-18,
CREW XP 900 '14-19,
CREW DIESEL '15-18

2-SEAT & CREW

- » 2-SEAT • 2879990 • \$44⁹⁹
570 '15-19, 500 '17-19
- » CREW • 2880929 • \$74⁹⁹
CREW 570-4 '15-19

ACCENT LIGHTING

ACCENT LIGHTS

- Kit includes four LEDs and all harnessing/switching required
- Single light can be added on to the kit (kit required)
- Durable off-road ready construction that is both dust- and water-resistant
- Control hub and complete instructions included



COLOR	LIGHTING KIT	SINGLE LIGHT
RED	2880500 • \$209 ⁹⁹	2880532 • \$54 ⁹⁹
BLUE	2880506 • \$209 ⁹⁹	2880533 • \$54 ⁹⁹

CREW XP 1000 '17-18,
XP 900 '13-19, CREW XP 900 '14-19,
DIESEL '15-18, CREW DIESEL '15-18

PRO ARMOR®

Polaris® & Pro Armor® developed a deep partnership thanks to having similar histories and a passion for producing products that enhance vehicle performance. Each wheel & tire Pro Armor® designs and engineers for Polaris® Off-Road Vehicles performs perfectly in the intended environment for its intended use. Developed, tested and produced in partnership so you can tackle the terrain ahead.

TRIPLE-BELTED SIDEWALLS

Sidewalls can be a vulnerable area of any off-road tire. Thanks to reinforced construction in this critical area, Pro Armor® resists when others fail.

10-PLY

Pro Armor® builds the toughest tires to keep you running when the terrain turns tough. A higher ply rating means added protection.

INNOVATION

A dual-durometer design allows the tire to wear better with softer outer lugs and harder inner lugs.

TIRE: **DUAL-THREAT**

WHEEL: **BUCKLE ACCENT**

4,828+ KILOMETER RATED

Pile on the kilometers with Pro Armor® tires. Every tire is designed and constructed with longevity in mind, you are assured long life and performance.

KNOW YOUR TIRES

DIMENSIONS

28" x 9" R14

TIRE HEIGHT | TIRE WIDTH | WHEEL DIAMETER

TREAD DEPTH

Deeper tread = more grip & cleaner performance

WEIGHT

A lighter tire makes for improved vehicle performance

PLY RATING

Indicates the puncture-resistance of a tire

SIDEWALL BELTS

Increase your resistance to sidewall punctures

LOAD RATING

Tires with higher load ratings can handle more weight

BACKCOUNTRY/TRAIL



PRO ARMOR® DUAL-THREAT

- Dual-compound technology and radial construction offer performance in all terrains
- Softer durometer rubber on outer edge for overall superior grip and feel
- Harder durometer rubber in the middle for increased traction during acceleration and longer tread life

		TREAD DEPTH	TIRE WEIGHT	PLY RATING	SIDEWALL BELTS	LOAD RATING
14" ↓	26" x 9" R14 5416340 • 219 #	FRONT	12 kg	10	3	413 kg
14" ↓	26" x 11" R14 5416341 • 229 #	REAR	14 kg			503 kg
14" ↓	29" x 9" R14 5416342 • 269 #	FRONT	14 kg			503 kg
14" ↓	29" x 11" R14 5416343 • 279 #	REAR	16 kg			599 kg



DUAL-COMPOUND = MORE GRIP + LONGER LIFE

Firmer Durometer Rubber = Longer Life.
Softer Durometer Rubber = More Grip.

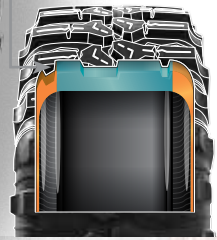

PRO ARMOR® ATTACK 2.0

- Engineered for excellent hard-pack performance
- Dual-compound technology and radial construction offer performance in all terrains.
- Tight tread pattern for quieter ride

		TREAD DEPTH	TIRE WEIGHT	PLY RATING	SIDEWALL BELTS	LOAD RATING
15" ↓	28" x 10" R15 5416344 • 269 #	FRONT/REAR	25mm	10	3	503 kg



WHEEL SIZE

15"

ATTACK 2.0 VS. ATTACK

- **Tighter Tread Pattern** = Better traction in hard pack
- **Dual-Durometer Lug** = Increased grip & traction in rough terrain, smoother ride in all terrain
- **10-Ply Rated** = Increased durability
- **Larger size offering in 28"** = More ground clearance & trail traction



PRO ARMOR® ATTACK

- The best all-purpose tire for all-season traction in any terrain
- Unique, full-face tread design
- Harder durometer lugs promote extended wear, increasing tire life
- Wider spaced lugs provide more grip in softer terrain

		TREAD DEPTH	TIRE WEIGHT	PLY RATING	SIDEWALL BELTS	LOAD RATING
14" ↓	26" x 9" R14 5415613 • 189 #	FRONT	13 kg	8	3	413 kg
14" ↓	26" x 11" R14 5415614 • 209 #	REAR	15 kg			599 kg



WHEEL SIZE

14"

COMMON

3-SEAT 8-BREW / 2-SEAT 8-BREW

WINCH

PLOWS

LIGHTING

WHEELS 6 TIRES

COOLERS

HUNT

FISH / YOUTH

THE RIGHT TIRES

FOR WORK. Pro Armor® Utility Tires are built to provide exactly what you need for your application. Need a high-kilometer work horse? We've got it. Need a turf-friendly tire with low-impact? We've got those too. Looking for the most extreme puncture resistance? Check.



"We use our RANGER® every day around the farm. We put the Pro Armor HARVESTER® Tires on last fall, We love them! We have received better traction as well as a gentler and quieter ride compared to the stock tires whether around the yard or out to the fields. They are so gentle on the lawn; we don't worry about driving the kids anywhere around the farm. We've had them on for a year and can't even see wear and tear, these are the best tires for my RANGER."

- BOB S., BARRON, WISCONSIN

PRO ARMOR HARVESTER®



PRO ARMOR PRESERVE™



PRO ARMOR XD-K



PICKING THE RIGHT UTILITY TIRE

UTILITY FEATURE	HARVESTER	PRESERVE™	XD-K
8,047 Kilometer Rated Long life and performance	X	X	
10-Ply Rated Higher ply ratings means added protection	X	X	X
Low Impact Tread Easy on soil		X	
Heavy Duty Tread Aggressive tread pattern for all day work on farms or ranches	X		X
Turf-Friendly Easy on grass & farm yard	X	X	
Aramid Fiber Belt 5x times stronger than steel and lighter			X
Wide Range of Sizes For exactly how you want to use your machine	28", 27", 26"	27", 26"	26"

UTILITY



PRO ARMOR HARVESTER®

- All-around work horse with tread life of 8047 km
- Tread pattern designed to withstand anything from the farmyard to the pastures and the trail
- With 10-ply, it can carry the load day in and day out

			TREAD DEPTH	TIRE WEIGHT	PLY RATING	SIDEWALL BELTS	LOAD RATING
14" ↓	28" × 10" R14 5416347 • 269 #	FRONT/ REAR	16mm	15 kg	10	3	599 kg
14" ↓	27" × 10" R14 5415965 • 249 #	FRONT/ REAR		15 kg			599 kg
12" ↓	26" × 8" R12 5416396 • 229 #	FRONT		11 kg			388 kg
12" ↓	26" × 10" R12 5415966 • 249 #	REAR		15 kg			615 kg



PRO ARMOR® PRESERVE™

- Turf-friendly for areas where low-impact from tire tread is needed
- Rounded profile and special tread pattern to limit footprint

			TREAD DEPTH	TIRE WEIGHT	PLY RATING	SIDEWALL BELTS	LOAD RATING
14" ↓	27" × 10" R14 5416348 • 249 #	FRONT/ REAR	16mm	13 kg	10	3	630 kg
12" ↓	26" × 8" R12 5416403 • 229 #	FRONT		11 kg			388 kg
12" ↓	26" × 10" R12 5416402 • 249 #	REAR		13 kg			599 kg



PRO ARMOR® XD-K

- 26" Aramid fiber-belted tire to tackle any terrain
- Unique full-face tread design
- Harder durometer lugs promotes extended wear, increasing tire life

			TREAD DEPTH	TIRE WEIGHT	PLY RATING	SIDEWALL BELTS	LOAD RATING
12" ↓	26" × 9" R12 5415656 • 247 #	FRONT	31.7mm	13 kg	10	3/1 Aramid Fiber Belt	388 kg
12" ↓	26" × 11" R12 5415757 • 260 #	REAR		15 kg			499 kg



COMMON

3-SEAT 8 BREW /
2-SEAT 8 BREW

WINCH

PLOWS

LIGHTING

WHEELS 6 TIRES

COOLERS

HUNT

FISH / YOUTH

ROCK



PRO ARMOR® CRAWLER XR

- Wanna race? This tire grips it all, from the trail to the rocks
- Square block profile for even surface contact
- A tougher durometer than the XG to take on the toughest the trail has to offer

	TREAD DEPTH	TIRE WEIGHT	PLY RATING	SIDEWALL BELTS	LOAD RATING	
14" 28" x 10" R14 5415536 • 259 ^{mm}	FRONT/ REAR	16mm	15 kg	8	3	517 kg



SINGLE-DUROMETER

Smaller lug height and single-durometer gives this high-speed tire added construction and lateral stability when cornering. Its unique lug design excels in hard-packed, fast terrain.



PRO ARMOR® CRAWLER XG

- Big or small, these tires crawl them all
- A soft, sticky compound makes this tire ideal for both rock crawling and desert running
- 8-ply, triple-belted ballistic sidewalls resist punctures

	TREAD DEPTH	TIRE WEIGHT	PLY RATING	SIDEWALL BELTS	LOAD RATING	
15" 28" x 10" R15 5416346 • 269 ^{mm}	FRONT/ REAR	20mm	15 kg	8	3	499 kg



DUAL-DUROMETER

With its taller lug height and dual-durometer construction, this tire has the perfect balance between high-speed performance, durability and flex in order to grip slick rock.

MUD



PRO ARMOR® DAGGER

- From the trails to the pits, this tire gets you through it all
- Deep, self-cleaning lugs and wide tire design for exceptional mud pit performance
- Rounded profile and full lug pattern for on-trail comfort

	TREAD DEPTH	TIRE WEIGHT	PLY RATING	SIDEWALL BELTS	LOAD RATING	
14" 27" x 9" R14 5415617 • 279 ^{mm}	FRONT	318mm	15 kg	8	3	499 kg
14" 27" x 11" R14 5415618 • 299 ^{mm}	REAR					18 kg



SELF-CLEANING AREAS

WHEELS

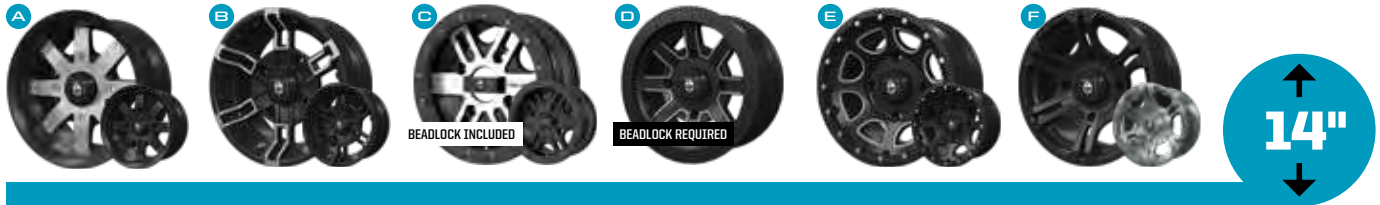

A AMPLIFY

FRONT:	Weight: 5.9 kg	Offset: -9		
	Load Rating: 408 kg			
REAR:	Weight: 6.4 kg	Offset: +4		
	Load Rating: 590 kg			
ACCENT:	FRONT	14" x 7"	1522956-266	\$189 ⁹⁹
	REAR	14" x 8"	1522957-266	\$209 ⁹⁹
MATTE BLACK:	FRONT	14" x 7"	1522956-458	\$169 ⁹⁹
	REAR	14" x 8"	1522957-458	\$179 ⁹⁹

E BUCKLE

FRONT:	Weight: 5.8 kg	Offset: +4		
	Load Rating: 408 kg			
REAR:	Weight: 6.1 kg	Offset: -9		
	Load Rating: 590 kg			
ACCENT:	FRONT	14" x 7"	1522544-266	\$189 ⁹⁹
	REAR	14" x 8"	1522545-266	\$209 ⁹⁹
MATTE BLACK:	FRONT	14" x 7"	1522544-458	\$169 ⁹⁹
	REAR	14" x 8"	1522545-458	\$179 ⁹⁹

C COMBAT (BEADLOCK RINGS INCLUDED)

FRONT/REAR:	Weight: 7.3 kg	Offset: +38		
	Load Rating: 726 kg			
ACCENT:	FRONT/REAR	14" x 7"	1523284	\$269 ⁹⁹
MATTE BLACK:	FRONT/REAR	14" x 7"	1523283	\$259 ⁹⁹

D REBLR (BEADLOCK RINGS SOLD SEPARATELY)

FRONT:	Weight: 5.9 kg	Offset: +4		
	Load Rating: 408 kg			
REAR:	Weight: 6.6 kg	Offset: -9		
	Load Rating: 590 kg			
ACCENT:	FRONT	14" x 7"	1522238-458	\$279 ⁹⁹
	REAR	14" x 8"	1522239-458	\$279 ⁹⁹

E SHACKLE

FRONT:	Weight: 5.9 kg	Offset: +4		
	Load Rating: 408 kg			
REAR:	Weight: 6.4 kg	Offset: -9		
	Load Rating: 590 kg			
ACCENT:	FRONT	14" x 7"	1522546-266	\$189 ⁹⁹
	REAR	14" x 8"	1522547-266	\$189 ⁹⁹
MATTE BLACK:	FRONT	14" x 7"	1522546-458	\$169 ⁹⁹
	REAR	14" x 8"	1522547-458	\$169 ⁹⁹

F SIX'R

FRONT:	Weight: 4.8 kg	Offset: +4		
	Load Rating: 408 kg			
REAR:	Weight: 5.7 kg	Offset: -9		
	Load Rating: 590 kg			
MATTE BLACK:	FRONT	14" x 7"	1521507-521	\$149 ⁹⁹
	REAR	14" x 8"	1521508-521	\$169 ⁹⁹
LUSTER:	FRONT	14" x 7"	1521507-410	\$189 ⁹⁹
	REAR	14" x 8"	1521508-410	\$199 ⁹⁹



G CYCLONE

FRONT/REAR:	Weight: 7.8 kg	Offset: +4		
	Load Rating: 590 kg			
ACCENT:	FRONT/REAR	15" x 7"	1523184-266	\$179 ⁹⁹
MATTE BLACK:	FRONT/REAR	15" x 7"	1523184-458	\$149 ⁹⁹

H HALO (BEADLOCK RINGS INCLUDED)

FRONT/REAR:	Weight: 7.7 kg	Offset: +38		
	Load Rating: 726 kg			
ACCENT:	FRONT/REAR	14" x 7"	1523282	\$299 ⁹⁹
MATTE BLACK:	FRONT/REAR	14" x 7"	1523286	\$269 ⁹⁹

I WYDE (BEADLOCK RINGS SOLD SEPARATELY)

FRONT/REAR:	Weight: 6.1 kg	Offset: +55		
	Load Rating: 590 kg			
ACCENT:	FRONT/REAR	15" x 7"	1522550-266	\$269 ⁹⁹
MATTE BLACK:	FRONT/REAR	15" x 7"	1522550-458	\$249 ⁹⁹

J HEXLR (BEADLOCK RINGS SOLD SEPARATELY)

FRONT/REAR:	Weight: 7.3 kg	Offset: +38		
	Load Rating: 590 kg			
ACCENT:	FRONT/REAR	15" x 7"	1522435-458	\$309 ⁹⁹

K FLARE

FRONT/REAR:	Weight: 8.1 kg	Offset: +4		
	Load Rating: 590 kg			
ACCENT:	FRONT/REAR	15" x 7"	1523102-266	\$179 ⁹⁹
MATTE BLACK:	FRONT/REAR	15" x 7"	1523102-458	\$149 ⁹⁹

LUG NUTS LUG NUTS REQUIRED

SEE PAGE 72

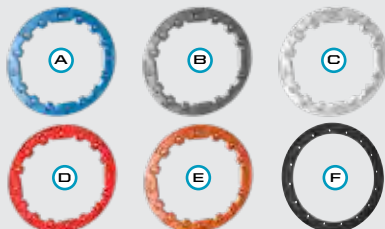

14" FORGED BEADLOCK RINGS

Only used on REBLR

	PART #	
A	Voodoo Blue	1522244-619 \$114 ⁹⁹
B	Machined	1522244-266 \$114 ⁹⁹
C	White	1522244-133 \$114 ⁹⁹
D	Indy Red	1522244-293 \$114 ⁹⁹
E	Orange Crush	1522244-589 \$114 ⁹⁹
F	Matte Black - Replacement Only used on Combat	1523146-458 \$74 ⁹⁹

15" FORGED BEADLOCK RINGS

Only used on HEXLR

	PART #	
A	Voodoo Blue	1522240-619 \$134 ⁹⁹
B	Machined	1522240-266 \$134 ⁹⁹
C	White	1522240-133 \$134 ⁹⁹
D	Indy Red	1522240-293 \$134 ⁹⁹
E	Orange Crush	1522240-589 \$134 ⁹⁹
F	Matte Black - Replacement Only used on Halo	1523147-458 \$79 ⁹⁹

WHEEL & TIRE SETS



UTILITY

ROCK/RACE

	HARVESTER 28" 5,000 Miles	HARVESTER 27" 5,000 Miles	PRESERVE™ 27" 5,000 Miles	CRAWLER XR 28" 3,000 Miles
AMPLIFY <i>Accent</i>	2883225 \$1,859 ⁹⁹	2882388 \$1,739 ⁹⁹	2883208 \$1,739 ⁹⁹	2882394 \$1,739 ⁹⁹
AMPLIFY <i>Matte Black</i>	2883226 \$1,739 ⁹⁹	2882389 \$1,599 ⁹⁹	2883209 \$1,599 ⁹⁹	2882395 \$1,599 ⁹⁹
BUCKLE <i>Accent</i>	2883220 \$1,859 ⁹⁹	2882383 \$1,739 ⁹⁹	2883203 \$1,739 ⁹⁹	2881343 \$1,739 ⁹⁹
BUCKLE <i>Matte Black</i>	2883221 \$1,739 ⁹⁹	2882384 \$1,599 ⁹⁹	2883204 \$1,599 ⁹⁹	2881344 \$1,599 ⁹⁹
COMBAT <i>Accent</i> BEADLOCKS PRE-MOUNTED				2883213 \$2,139 ⁹⁹
COMBAT <i>Matte Black</i> BEADLOCKS PRE-MOUNTED				2883212 \$1,999 ⁹⁹
REBLR <i>Matte Black</i> BEADLOCKS SOLD SEPARATELY				2881386 \$1,999 ⁹⁹
SHACKLE <i>Accent</i>	2883222 \$1,859 ⁹⁹	2882385 \$1,739 ⁹⁹	2883205 \$1,739 ⁹⁹	2881355 \$1,739 ⁹⁹
SHACKLE <i>Matte Black</i>	2883223 \$1,739 ⁹⁹	2882386 \$1,599 ⁹⁹	2883206 \$1,599 ⁹⁹	2881356 \$1,599 ⁹⁹
SIXR <i>Luster</i>				2881371 \$1,739 ⁹⁹
SIXR <i>Matte Black</i>	2883224 \$1,739 ⁹⁹	2882387 \$1,599 ⁹⁹	2883207 \$1,599 ⁹⁹	2881372 \$1,599 ⁹⁹



TRAIL

ROCK/RACE

	ATTACK 2.0 28" 3,000 Miles	CRAWLER XG 28" 3,000 Miles
CYCLONE <i>Accent</i>	2883160 \$1,799 ⁹⁹	2883188 \$1,799 ⁹⁹
CYCLONE <i>Matte Black</i>	2883159 \$1,669 ⁹⁹	2883187 \$1,669 ⁹⁹
FLARE <i>Accent</i>	2883158 \$1,799 ⁹⁹	2883186 \$1,799 ⁹⁹
FLARE <i>Matte Black</i>	2883157 \$1,669 ⁹⁹	2883185 \$1,669 ⁹⁹
HALO <i>Accent</i> BEADLOCKS PRE-MOUNTED	2883162 \$2,169 ⁹⁹	2883190 \$2,169 ⁹⁹
HALO <i>Matte Black</i> BEADLOCKS PRE-MOUNTED	2883161 \$2,059 ⁹⁹	2883189 \$2,059 ⁹⁹
HEXLR <i>Matte Black</i> BEADLOCKS SOLD SEPARATELY	2883154 \$2,059 ⁹⁹	2883182 \$2,059 ⁹⁹
WYDE <i>Accent</i>	2883156 \$1,799 ⁹⁹	2883184 \$1,799 ⁹⁹
WYDE <i>Matte Black</i>	2883155 \$1,669 ⁹⁹	2883183 \$1,669 ⁹⁹

LUG NUTS

⊗ LUG NUTS REQUIRED

12MM X 1.5 SPLINED LUG NUTS

16 LUG NUTS WITH WRENCH	ALL POLARIS RANGER® 3-SEAT & CREW MODELS	2879332 • \$54 ⁹⁹
4 LUG NUTS WITHOUT WRENCH		2879331 • \$18 ⁹⁹
SPLINED LUG WRENCH		2204966 • \$12 ⁹⁹

3/8" - 24 HEX LUG NUTS

16 HEX LUG NUTS	570 FULL-SIZE '16-19, CREW 570 FULL-SIZE '16-19, 570 '15-19, CREW 570-4 '15-19, 500 '17-19, EV '15-19, EV LHON '16-18	2877409 • \$43 ⁹⁹
4 HEX LUG NUTS		2876754 • \$18 ⁹⁹



2 WAYS TO PURCHASE

INDIVIDUAL WHEELS & TIRES
- OR -
COMPLETE SETS AS LISTED

VISIT Polaris.com/ProArmorRANGER TO BUILD YOUR CUSTOM SET

Exclusively at Polaris® Authorized Dealers or Polaris.com/ProArmorRANGER

BACKCOUNTRY/TRAIL

DUAL-THREAT 29" 4,828 km	DUAL-THREAT 26" 4,828 km	ATTACK 26" 4,828 km
2883146 \$1,859 ⁹⁹	2883138 \$1,669 ⁹⁹	2882390 \$1,489 ⁹⁹
2883147 \$1,739 ⁹⁹	2883139 \$1,539 ⁹⁹	2882391 \$1,359 ⁹⁹
2883148 \$1,859 ⁹⁹	2883140 \$1,699 ⁹⁹	2881335 \$1,599 ⁹⁹
2883149 \$1,739 ⁹⁹	2883141 \$1,539 ⁹⁹	2881336 \$1,479 ⁹⁹
2883219 \$2,269 ⁹⁹	2883217 \$2,059 ⁹⁹	
2883218 \$2,139 ⁹⁹	2883216 \$1,939 ⁹⁹	
		2881381 \$1,669 ⁹⁹
2883150 \$1,859 ⁹⁹	2883142 \$1,699 ⁹⁹	2881347 \$1,599 ⁹⁹
2883151 \$1,739 ⁹⁹	2883143 \$1,539 ⁹⁹	2881348 \$1,479 ⁹⁹
		2881359 \$1,599 ⁹⁹
2883152 \$1,739 ⁹⁹	2883144 \$1,539 ⁹⁹	2881360 \$1,479 ⁹⁹



2 EASY STEPS 1) CHOOSE YOUR MOUNT 2) CHOOSE YOUR TRACK

PROSPECTOR PRO® TRACK SYSTEM

- Polaris® exclusive optimized hub geometry that minimizes feedback and eases steering effort
- Flexible lug design for the highest level of deep snow performance by lifting up in deep snow as opposed to digging down
- Lightweight design with slight weight reduction over Camoplast® kit provides for better flotation, eases steering effort and provides better vehicle control

PROSPECTOR PRO® TRACK MOUNTS

- Install this track system mounting hardware in place of tires and wheels. Tracks sold separately
- » 2882783 • \$649⁹⁹
XP 1000 '18-19, CREW XP 1000 '19
DOES NOT FIT HIGHLIFTER MODELS
- » 2879621 • \$649⁹⁹
XP 1000 '17, CREW XP 1000 '17-18, XP 900 '13-19, CREW XP 900 '14-19, DIESEL '14-18, CREW DIESEL '16-18
DOES NOT FIT HIGHLIFTER MODELS
- » 2880071 • \$649⁹⁹
570 '14-19, CREW 570-4 '15-19, 500 '17-19

PROSPECTOR PRO® TRACK

- » 2883313 • \$6,449⁹⁹
XP 1000 '18-19, CREW XP 1000 '18-19, XP 900 '18-19, CREW XP 900 '18-19
DOES NOT FIT HIGHLIFTER MODELS
- » 2880757 • \$6,449⁹⁹
XP 900 / 900 (NON-EPS) '13-19, 570 (NON-EPS) '14-19, CREW 570-4 (NON-EPS) '14-19, 500 '17-19
- » 2880758 • \$6,449⁹⁹
XP 1000 '17, CREW XP 1000 '17, XP 900 EPS '16-17, CREW XP 900 EPS '16-17, DIESEL '14-18, CREW DIESEL '16-18, 570 (EPS) '14-19, CREW 570-4 (EPS) '14-19
DOES NOT FIT HIGHLIFTER MODELS

If using Glacier® Pro Plow System with tracks, Track Plow Extension is required (2889267)

For year-round use, Polaris recommends the use of Intake Update Kit (2880673) on any Ranger XP 900 '13-19, RANGER XP® 1000 '17, RANGER XP® 900/1000 CREW '14-18 with tracks installed. To keep intake system working optimally, this kit pre-filters out fine snow and dust.

REPLACEMENT CAPS

POLARIS® CAPS



LUSTER	ALL WHEELS EXCEPT WYDE & HEXLR	1521509-410 • \$15 ⁹⁹
MATTE BLACK		1521509-521 • \$15 ⁹⁹
LUSTER	HEXLR	1522243-410 • \$30 ⁹⁹
MATTE BLACK		1522243-458 • \$30 ⁹⁹

PRO ARMOR® CAPS



LUSTER	ALL WHEELS EXCEPT WYDE & HEXLR	5453209-410 • \$15 ⁹⁹
MATTE BLACK		5453209-458 • \$15 ⁹⁹
MATTE BLACK	WYDE	1523063-458 • \$15 ⁹⁹
LUSTER	HEXLR	1523015-410 • \$15 ⁹⁹
MATTE BLACK		1523015-458 • \$15 ⁹⁹

TIRE SEALANT

- » 32 OZ. • 2830484 • \$23⁹⁹
- » 1 GALLON • 2830485 • \$82⁹⁹
- » 5 GALLON • 2830486 • \$346⁹⁹
- » 5 GALLON PUMP • 2830487 • \$154⁹⁹



COLBY VALVE SHORT ULTIMATE VALVE - 2 PACK

- » 2883292 • \$54⁹⁹



COLBY VALVE EMERGENCY VALVE - 2 PACK

- » 2883293 • \$54⁹⁹



COLBY VALVE BOX COMBO

- Includes 8 Ultimate & 8 Emergency Valves
- » 2883294 • \$749⁹⁹

KEEP IT ICE COLD

POLARIS NORTHSTAR® COOLERS can survive just about anything - from extreme heat to a nasty tumble off a vehicle. So when we say ice will stay cold for hours on end and anything inside will stay locked up tight, we mean it.

POLARIS NORTHSTAR® COOLER



105

105 QUART

» GRAPHITE • 2883426 • **\$509⁹⁹**
» DESERT • 2883392 • **\$509⁹⁹**



60

60 QUART

» GRAPHITE • 2883425 • **\$409⁹⁹**
» DESERT • 2881259 • **\$409⁹⁹**



30

30 QUART

» GRAPHITE • 2883424 • **\$309⁹⁹**
» DESERT • 2881315 • **\$309⁹⁹**



15

15 QUART **NEW**

» GRAPHITE • 2883968 • **\$249⁹⁹**



20 QUART SOFTSIDE

» GRAPHITE • 2883390 • **\$209⁹⁹**

30, 60 & 105 QUART FEATURES



ComfortCarry
Handles



TravelLock
System



EasyOut
Drain System



NoSlip
Rubber Feet



PolarWall
Insulation



IceLock
Seal



TUMBLERS

» 30 OZ • 2883394 • **\$36⁹⁹**
» 20 OZ • 2883393 • **\$30⁹⁹**

GRIZZLY TESTED. POLARIS® APPROVED.



This cooler is IGBC-approved, meaning it withstands the power expended by a typical grizzly bear if it was trying to get inside. Seriously, there are experts who know what a grizzly is capable of doing, and they certify that the Polaris Northstar® Cooler can take it.



POLARIS NORTHSTAR® COOLER ACCESSORIES



WIRE BASKET

- » 105 QUART • 2883648 • **\$59⁹⁹** **NEW**
- » 60 QUART • 2882185 • **\$43⁹⁹**
- » 30 QUART • 2882438 • **\$36⁹⁹**



DIVIDERS

- » 105 QUART • 2883468 • **\$43⁹⁹** **NEW**
COMES WITH ONE DIVIDER
 - » 60 QUART • 2882184 • **\$59⁹⁹**
COMES WITH TWO DIVIDERS
 - » 30 QUART • 2882186 • **\$30⁹⁹**
COMES WITH ONE DIVIDER
- Divider doubles as a cutting board



SEAT CUSHION

- » 60 QUART • 2882179 • **\$114⁹⁹**
- » 30 QUART • 2882507 • **\$89⁹⁹**

COOLER WHEELS

- » 60 QUART • 2882180 • **\$124⁹⁹**

BOTTLE OPENER

- » 2882183 • **\$15⁹⁹**
ALL COOLERS

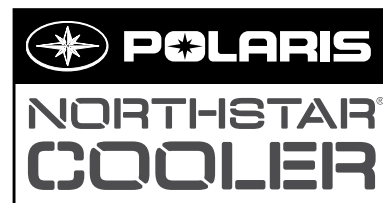

HOLDS ICE
30+
HOURS
LONGER
THAN YETI®*

*YETI® is a registered trademark of YETI COOLERS, LLC



LOCK & RIDE QUICKSTRAP

- » 2882187 • **\$59⁹⁹**
ALL COOLERS, RANGER® AND POLARIS GENERAL CARGO BOXES



NEW 1.5" X 15' 5,500 LB RATCHET STRAP

- Heavy duty webbing
- 5,500 Lb. Maximum Load / 1,833 Lb. Working Load
- 2 Pack
- » 2884031 • **\$59⁹⁹**



NEW 2" X 20' 10,000 LB RATCHET STRAP

- Heavy duty webbing
- 10,000 Lb. Maximum Load / 3,300 Lb. Working Load
- Floating D-Rings
- Double J-Hooks
- » 2884032 • **\$43⁹⁹**

COMMON

3-SEAT 8 DREW / 2-SEAT 8 DREW

WINCH

PLOWS

LIGHTING

WHEELS & TIRES

COOLERS

HUNT

FISH / YOUTH

PROTECT THE GEAR YOU NEED. LIVE THE LIFE YOU LOVE.



View this RANGER® & make it your own
[POLARIS.COM/RANGERhunt1000](https://www.polaris.com/RANGERhunt1000)

RANGER XP® 1000 EPS
Polaris® Pursuit® Camo

KOLPIN STRONGHOLD® SYSTEM

Polaris® is proud to partner with Kolpin® Outdoors, an industry leader in off-road accessories and the premier name in gun boots and mounts. If you need to secure a firearm, ice fishing rods, an ice auger or a pop-up blind while riding, simply attach the auto-latch mount and choose your case.

IDEAL FOR SCOPED RIFLES, SHOTGUNS AND LONG-BARRELED PISTOLS

STEP 1 CHOOSE YOUR MOUNT

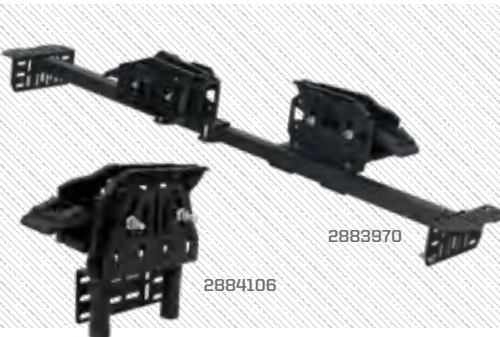

STEP 2 CHOOSE YOUR BOOTS



Includes
Transport Case

LOCK & RIDE AUTO-LATCH MOUNT

- Precision angle adjustable for a custom fit
- Provides a quick and secure attachment point

» **DOUBLE BOOT MOUNT** •
2883970 • **\$234⁹⁹**

» **SINGLE BOOT MOUNT** •
2884106 • **\$83⁹⁹**

XP 1000 '17-19, CREW XP 1000 '17-19, XP 900 '13-19, CREW XP 900 '14-19,
DIESEL '15-18, CREW DIESEL '15-18, 570 FULL-SIZE '16-19,
CREW 570 FULL-SIZE '16-19

GUN BOOT® XL – TRANSPORT

- 52" L x 3¾" W x 10½" H

» 2882430 • **\$129⁹⁹**

Requires Auto-Latch Mount
(2883970 or 2884106)

GUN BOOT® L – IMPACT

- 52" x 4¾" x 9-¼"H

» 2882426 • **\$83⁹⁹**

Requires Auto-Latch Mount
(2883970 or 2884106)

PISTOL BOOT

- 15½" L X 2½" W x 8¾" H

» 2882429 • **\$69⁹⁹**

Requires Auto-Latch Mount
(2883970 or 2884106)



KOLPIN STRONGHOLD® PRODUCTS SECURELY PROTECT THE ESSENTIALS WHEN ON THE TRAIL.

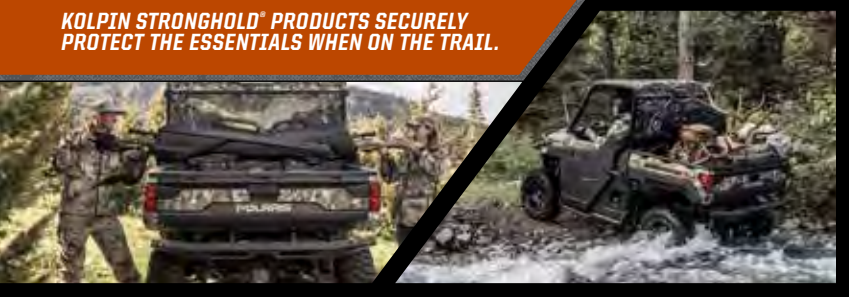

ICE AUGER / POP-UP BLIND BOOT

• 46" L X 12½" W

» 2882427 • \$109⁹⁹

Requires Auto-Latch Mount (2883970 or 2884106)

ICE ROD BOOT

• 39" x 18½" x 6" H

» 2882428 • \$129⁹⁹

Requires Auto-Latch Mount (2883970 or 2884106)

KOLPIN RHINO GRIPS®



IDEAL FOR BOWS, CROSSBOWS AND UNCASSED LONG GUNS



LOCK & RIDE

RHINO GRIP PRO BY KOLPIN®

» 2884107 • \$109⁹⁹

ALL RANGER® MODELS (EXCEPT 150)



LOCK & RIDE

RATCHETING RHINO GRIP® BY KOLPIN®

» 2881575 • \$90⁹⁹

ALL RANGER® MODELS (EXCEPT 150)



LOCK & RIDE

RHINO GRIP XL DOUBLE BY KOLPIN®

» 2884108 • \$94⁹⁹

ALL RANGER® MODELS (EXCEPT 150)



LOCK & RIDE

RHINO GRIP XL BY KOLPIN®

» 2881574 • \$62⁹⁹

ALL RANGER® MODELS (EXCEPT 150)



RHINO GRIP PRO RUBBER STRAPS BY KOLPIN

» 2884109 • \$11⁹⁹

RHINO GRIP® PRO



RHINO GRIP XL RUBBER STRAPS BY KOLPIN®

» 2881621 • \$7⁴⁹

RHINO GRIP® XL

THANKS TO OUR PARTNERS. We would like to thank our partners Browning® and Mathews® for helping to deliver a successful and safe off-road experience when out in the field.



Browning® is a registered trademark of Browning. Mathews® is a registered trademark of Mathews Archery Inc.

COMMON

3-SEAT 8 BREW / 2-SEAT 8 BREW

WINCH

PLOWS

LIGHTING

WHEELS & TIRES

COOLERS

HUNT

FISH / YOUTH

THIS SEASON

ELEVATE YOUR PURSUIT

AND LEAVE NOTHING TO CHANCE

GEAR UP WITH THE RIGHT ACCESSORIES THAT CAN TAKE YOU TO FIND THE NEXT TROPHY. After you customize your cab with the new *RANGER* Pro Shield™ Cab System, add on the hunting essentials to keep your gear and gun safe across the rugged terrain.



IN-CAB GUN MOUNT

- Gives you instant gun access in the field
- Mounts securely to the floor and adjusts up to 45° forward
- Robust, molded gun butt holder at base
- Quick-release barrel straps
- Easily removable
- Accommodates scope-equipped rifles

» 2883263 • \$209⁹⁹

XP 1000 '18-19, CREW XP 1000 '19

» 2881537 • \$209⁹⁹

CREW XP 1000 '17-18,
XP 900 '13-19, CREW XP 900 '14-19,
DIESEL '15-18, CREW DIESEL '15-18,



LOCK & RIDE GUN RACK 6

- Adjustable to store guns at an angle or vertical (shown at angle)
- Holds 6 rifles or shotguns securely with soft rubber v-grips
- Stock is secured in place with a soft molded rubber inlay along the bottom of the rack
- Rack can be adjusted into 3 positions based on firearm height

» 2882159 • \$509⁹⁹

XP 1000 '17-19, CREW XP 1000 '17-19,
XP 900 '13-19, CREW XP 900 '14-19,
DIESEL '15-18, CREW DIESEL '15-18,
570 FULL-SIZE '16-19, CREW 570 FULL-SIZE '16-19



POLARIS® PURSUIT® CAMO SXS FIELD COVER

- Full-coverage camo print cover hides your side-by-side while in the field
- Lightweight material protects your *RANGER* from inclement weather

» 2882160 • \$169⁹⁹

ALL 3-SEAT & 2-SEAT RANGER® MODELS



View this RANGER® & make it your own
POLARIS.COM/HuntCrew
 RANGER CREW® XP 1000 EPS
 Polaris® Pursuit® Camo



LOCK & RIDE DOG KENNEL

- Drain holes in the bottom
- Rubber feet seamlessly fit in the indentations of the RANGER® Gear Vault for a secure fit
- Use the Lock & Ride® QuickStrap to secure to the cargo bed
- Lightweight with a molded handle in the top for easy carrying

» 2882354 • \$339⁹⁹
 ALL RANGER® MODELS (EXCEPT 150)



RANGER® GEAR VAULT

- Designed for a perfect fit in the cargo bed for the Full-Size RANGER®, can also be used in other trucks
- Water-resistant design, with two easy-to-pull handles with locking middle handle and two adjustable dividers to meet your hauling needs
- Integrated top depressions allow for an exact fit for the Lock & Ride® Dog Kennel, Polaris Northstar® Coolers (30 & 60 qt.), 5-gallon buckets and more

» 2882353 • \$869⁹⁹
 XP 1000 '17-19, CREW XP 1000 '17-19,
 XP 900 '13-19, CREW XP 900 '14-19,
 DIESEL '15-18, CREW DIESEL '15-18,
 570 FULL-SIZE '16-19, CREW 570 FULL-SIZE '16-19

COMMON

3-SEAT 8 CREW /
 2-SEAT 8 CREW

WINCH

PLOWS

LIGHTING

WHEELS & TIRES

COOLERS

HUNT

FISH / YOUTH

Otter®

LOCK & RIDE

Polaris® XT **NEW**
Pro Lodge by Otter



OTTER THERMAL **TEC**

OUTER SHELL

Provides outstanding wind & light blocking capabilities

INNER LINING

The full thermal quilted inner shell provides higher lofting while locking in heat & virtually eliminating condensation



LIGHTWEIGHT

Oversized square tube aluminum frame with anodized receiver tubes and ultra-glide operation



"The full-thermal Otter® Ice House from Polaris® sets up in minutes, is spacious enough for two anglers to fish in comfort and stows quickly on the back of your Ranger. It is the premium shelter solution for ice anglers that rely on their Polaris RANGER® for mobility out on the ice."

- James Holst, InDepth Outdoors

EASY SET UP



FEATURES

- Fits 1-2 people
- 26.5 square feet
- Set up dimensions: 67" L x 59 ½" W x 78 ½" H
- Cover included
- 2 top sealable vents
- Front entry door with dual coil zippers
- 2 sewn-in TPU crack resistant windows
- Insulated corners for complete coverage
- Interior draft skirt w/ extra-long perimeter



WARRANTY

POLARIS RANGER COMPATIBLE MODELS



XP 1000 '17-19,
CREW XP 1000 '17-19,



XP 900 '13-19,
CREW XP 900 '14-19,
DIESEL '15-18,
CREW DIESEL '15-18



570 FULL-SIZE '16-19,
CREW 570 FULL-SIZE '16-19

LOCK & RIDE

Polaris® XT
Pro Lodge
by Otter®

» 2882199 \$1,289⁹⁹

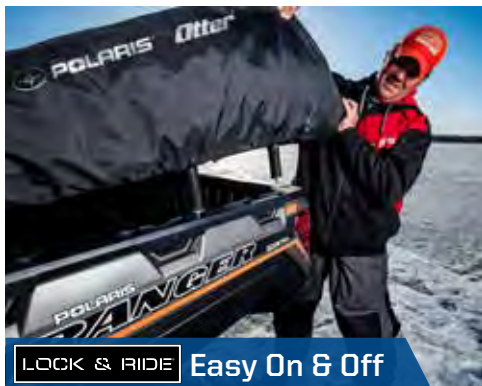

LOCK & RIDE Easy On & Off



Room for Ice Fishing Gear

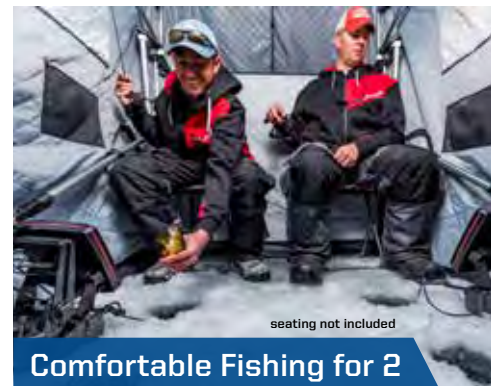

seating not included

Comfortable Fishing for 2

Otter® is a registered trademark of Otter Outdoors, LLC

HIT THE TRAILS

RANGER® 150

ACCESSORIES



COMMON

3-SEAT 8 CREW /
2-SEAT 6 CREW

WINCH

PLOW

LIGHTING

WHEELS & TIRES

COOLERS

HUNT

FISH / YOUTH



FULL-WINDSHIELD - POLY

- .125" clear poly carbonate
- Mounts with 4 simple p-clamps

» 2883288 **\$209⁹⁹**
150 '19



HALF-WINDSHIELD - POLY

- 13" tall
- .125" clear poly carbonate
- Mounts with 4 simple p-clamps

» 2883298 **\$134⁹⁹**
150 '19



SPORT ROOF - POLY

- Shields you from rain, snow, sun
- Easy install

» BLACK • 2883289 **\$269⁹⁹**
150 '19



FRONT & REAR BRUSHGUARD - SET

- Includes front & rear bumper
- Durable, E-coated steel construction

» BLACK • 2883287 **\$134⁹⁹**
150 '19



HUNT

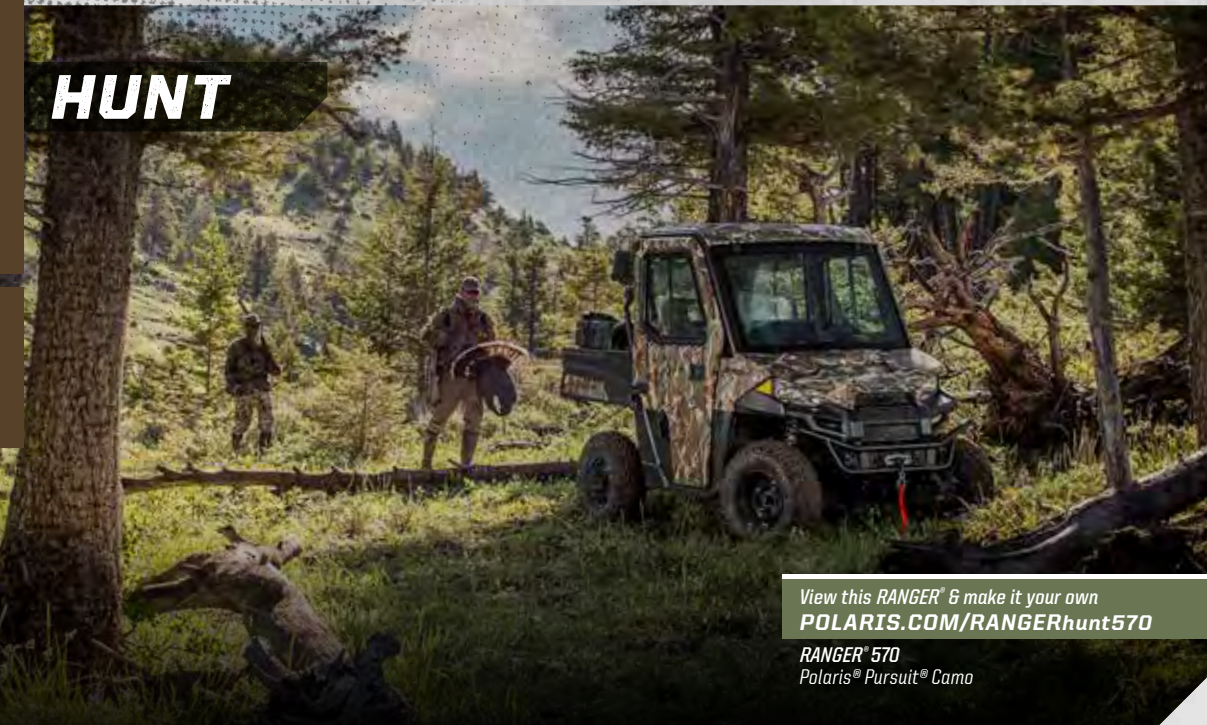

View this RANGER® & make it your own
[POLARIS.COM/RANGERhunt570](https://www.polaris.com/RANGERhunt570)

RANGER® 570
Polaris® Pursuit® Camo

WORK



RANGER® 570

POWER, COMFORT AND LEGENDARY RANGER® CAPABILITY combine to haul more, tow more and do more when you need it the most. Whether it's on your property, on the hunt, on the trail or at the work site, a mid-size RANGER® equipped with Polaris Engineered Accessories™ takes on all tasks.

MAKE

RANCH



View this RANGER® & make it your own
[POLARIS.COM/RANGERranch570](https://www.polaris.com/RANGERranch570)

RANGERCREW® 570-4 EPS
Nara Bronze

TRAIL



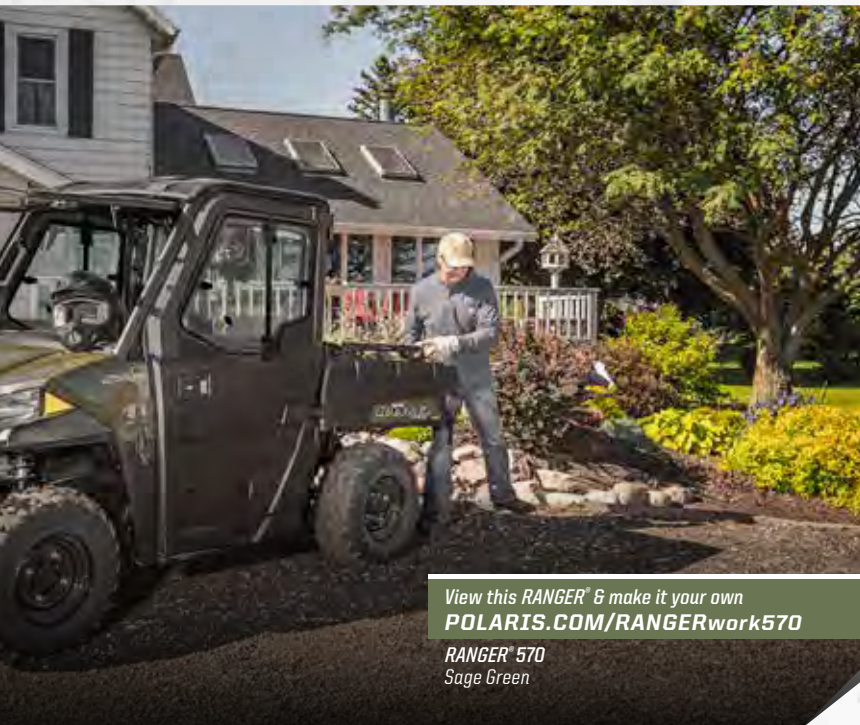

View this RANGER® & make it your own
POLARIS.COM/RANGERwork570

RANGER® 570
 Sage Green

/500/EV IT YOURS.



View this RANGER® & make it your own
POLARIS.COM/RANGERtrail500

RANGER® 500
 Solar Red

RANGER® 570 / 500 / EV BUILD THE RIGHT TOOL FOR THE JOB.

CAB COMFORT WITH THE RANGER® CAB SYSTEM

- Roof Pg 84
- Windshield Pg 86
- Rear Panel Pg 87
- Doors Pg 85
- Cab Comfort Pg 90

MAKE WORK EASIER WITH THE RIGHT TOOLS FOR THE JOB

- Polaris® Winches Pg 54
- Rigid® & Pro Armor® Lighting Pg 64
- Kolpin® & Polaris® Hunting Acces. Pg 76
- Cargo Bed Storage Options Pg 48
- GLACIER® Plow Systems Pg 58
- Pro Armor® Wheels & Tires Pg 66

THE RIGHT STUFF TO MAINTAIN YOUR RANGER®

- Oil & Lubricants Pg 94
- Maintenance Parts Pg 96

EVERYTHING YOU NEED TO GEAR UP FOR THE RIDE

- Helmets & Apparel Pg 108



BUILD YOUR OWN RANGER.®
POLARIS.COM/RANGER

POLARIS ENGINEERED™ ADVANTAGES



SEALED COVERAGE

Just as roof shingles overlap for seamless coverage, roofs extend over other cab components to add even more protection against the elements, delivering the best fit and seal.



KEEP MOISTURE MOVING

Keep precipitation moving with integrated roof water channels that direct water away from the cab, even when you're stationary.



REVOLUTIONARY INSTALLATION

Lock & Ride® roofs install directly into mounting points in the cab frame, and are easily installed or removed without tools.

OVERHEAD PROTECTION

TO SHIELD AGAINST DRIVING RAIN OR THE BLISTERING SUN, a roof is the first must-have of the Polaris Engineered Accessories™ line-up. Choose from poly or steel and know that you are protected from the elements with a seamless integrated roof.

POLY

Lightweight, durable and impact-resistant. A poly roof can take the abuse of a tight trail and still protect.



SPORT ROOF - POLY TOP SELLER

- Provides shade, superior overhead protection
- Tough injection-molded design resists distortion from the elements
- Polaris® Pursuit® Camo offers effective visual camouflage in the field

» 2-SEAT POLARIS® PURSUIT® CAMO • 2883237 • **\$809⁹⁹**

» 2-SEAT BLACK • 2883236 • **\$429⁹⁹**

570 '15-19, 500 '17-19, EV '15-19, EV LHON '16-18

» CREW BLACK • 2883238 • **\$709⁹⁹**

CREW 570-4 '15-19

STEEL

For the ultimate in strength and protection.

HD ROOF - STEEL

- Stout 12-gauge steel construction
- Powdercoated finish for scratch and corrosion resistance
- Interior fabric liner provides sound reduction

» 2-SEAT • 2879954 • **\$809⁹⁹**

570 '15-19, 500 '17-19, EV '15-19, EV LHON '16-18





COMPLETE YOUR CAB SYSTEM

POLY DOORS

CANVAS DOORS

HINGED WINDOW

- A premium, door offering hinged window for customizable ventilation in the cab.

ZIP WINDOW

- Lightweight, durable protection with adjustable zipper ventilation and see-through bottom panel.

FRONT DOORS

(SET OF 2) 570 '15-19, CREW 570-4 '15-19, 500 '17-19, EV '15-19, EV LHon '16-18



Hinged Window - Poly Doors - Polaris® Pursuit® Camo
2880636 | \$3,729⁹⁹

Hinged Window - Poly Doors - Black
2882247 | \$2,659⁹⁹



Zip Window Doors - Canvas - Black
2879963 | \$1,209⁹⁹

REAR DOORS

(SET OF 2) CREW 570-4 '15-19



Zip Window Doors - Rear - Canvas - Black
2879964 | \$1,209⁹⁹

POLARIS ENGINEERED™
ADVANTAGES



PREMIUM FEATURES

Automotive-like finish, solid latches, storage and more.

QUIETER AT IDLE

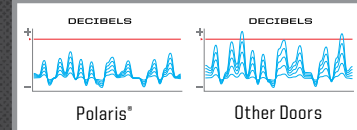

SOUND DAMPENING DOOR LINERS

Select doors come standard with sound-absorbing liners to help reduce in-cab noise.



UNPRECEDENTED VENTILATION OPTIONS

Choose from multiple window options –including hinged and zip-down windows. This allows you to find the perfect amount of ventilation and temperature regulation.



REVOLUTIONARY INSTALLATION

Adding or removing your doors is as simple as dropping them in and pulling them off. Easy, convenient, and takes only seconds to remove the restraint rubber strap.

2-SEAT & CREW

570/500

ROOFS & DOORS

GLASS WINDSHIELDS & REAR PANELS

POLY WINDSHIELDS & REAR PANELS

CAB COMFORT & PROTECTION

STORAGE

ULTIMATE CLARITY WITH GLASS

FOR THE ULTIMATE IN SCRATCH RESISTANCE AND CLARITY, nothing beats glass. It has the most optical clarity of any windshield material, and cuts the wind and harsh elements. Couple a rear panel with your windshield to reduce the dust swirl for a clean ride.



GLASS WINDSHIELDS



TIP-OUT WINDSHIELD - GLASS

- Made of strong, optical-grade laminate safety glass
- Provides optimal visibility and the best protection from wind, inclement weather and off-road hazards
- Minimal perimeter framework for a low profile and full visibility
- Tip-out feature lets riders adjust the windshield to an open position that allows riders to enjoy airflow in the cab

» 2881784 • \$1,329⁹⁹

570 '15-19, CREW 570-4 '15-19, 500 '17-19, EV '15-19, EV LI-ION '16-18



LOCK & RIDE FULL WINDSHIELD - GLASS

- Provides the highest level of scratch resistance

» 2881783 • \$809⁹⁹

570 '15-19, CREW 570-4 '15-19, 500 '17-19, EV '15-19, EV LI-ION '18

ADD ALL-WEATHER VISIBILITY
WINDSHIELD WIPER & WASHER SYSTEM
P. 90

POLARIS ENGINEERED™
ADVANTAGES

2-SEAT & CREW

570/500

ROOFS & DOORS

GLASS WINDSHIELDS & REAR PANELS

POLY WINDSHIELDS & REAR PANELS

CAB COMFORT & PROTECTION

STORAGE



TEMPERED SAFETY GLASS

For the ultimate in scratch resistance, tempered safety glass is the top choice. Optically, it is the clearest glass available, and because it is tempered, it's shatterproof.

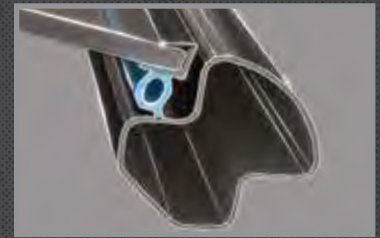

AIRTIGHT GASKET SEAL

RANGER® windshields feature a 360° gasket seal preventing moisture and dust from entering the cab.

REAR PANEL



REDUCE IN-CAB DUST SWIRL BY ADDING A REAR PANEL

With a windshield and roof installed, turbulent air develops behind the cab. Add a rear panel to reduce dust intrusion from this swirl.



MULTI-FUNCTION FEATURES

Venting options are useful for controlling airflow into the cab. This allows you to regulate the temperature inside. A low-profile exterior framework on the windshields gives an unobstructed field of vision.



LOCK & RIDE REAR PANEL - GLASS

• Durable, tempered laminate glass provides a high level of scratch resistance

» 2879965 • \$409⁹⁹

570 '15-19, CREW 570-4 '15-19, 500 '17-19, EV '15-19, EV LHON '16-18



REVOLUTIONARY INSTALLATION

Every Lock & Ride® windshield utilizes a unique clamp that secures your windshield with the perfect amount of hold for rough trail conditions, yet still allows for easy, tool-less removal.

DURABLE POLY PROTECTION

LIGHT AND FLEXIBLE, poly is impact-resistant, providing long-term value and protection. Whether you choose hard coat or general poly, you can hit the trail or job site with confidence, protection, and durability

HARD COAT POLY

Poly windshields covered by hard coat provide **30x MORE** scratch resistance than any standard poly windshields.

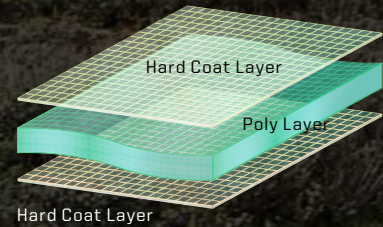

POLY WINDSHIELDS

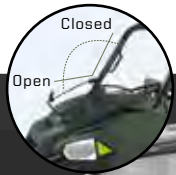

FLIP-DOWN WINDSHIELD - HARD COAT POLY

- 2 venting options: fully sealed or flip-down/remove upper half for some protection with maximum ventilation

» 2882178 • \$609⁹⁹

570 '15-19, CREW 570-4 '15-19, 500 '17-19, EV '15-19, EV LHON '16-18



LOCK & RIDE VENTED WINDSHIELD - HARD COAT POLY

- Frameless design for maximum visibility
- Added vents for airflow on a hot day or defrosting on a cold day

» 2883342 • \$669⁹⁹

570 '15-19, CREW 570-4 '15-19, 500 '17-19, EV '15-19, EV LHON '16-18



LOCK & RIDE FULL WINDSHIELD - HARD COAT POLY

- Durable, optical-grade, .236" thick polycarbonate offers outstanding rider protection & visibility
- Windshield has minimal perimeter framework for full visibility

» 2883319 • \$609⁹⁹

570 '15-19, CREW 570-4 '15-19, 500 '17-19, EV '15-19, EV LHON '16-18



LOCK & RIDE FULL WINDSHIELD - POLY

- Durable, optical-grade, .236" thick polycarbonate offers outstanding rider protection & visibility
- Windshield has minimal perimeter framework for full visibility

» 2883318 • \$469⁹⁹

570 '15-19, CREW 570-4 '15-19, 500 '17-19, EV '15-19, EV LHON '16-18



LOCK & RIDE HALF WINDSHIELD - POLY

- Strong, durable polycarbonate half windshield delivers a combination of protection & airflow into the cab
- Half windshield offers protection from rain, sleet, spray, & off-road hazards

» 2883320 • \$249⁹⁹

570 '15-19, CREW 570-4 '15-19, 500 '17-19, EV '15-19, EV LHON '16-18



POLARIS ENGINEERED™
ADVANTAGES

2-SEAT & CREW

570/500

ROOFS & DOORS

GLASS WINDSHIELDS
& REAR PANELS

POLY WINDSHIELDS
& REAR PANELS

CAB COMFORT &
PROTECTION

STORAGE

REAR PANELS



REDUCE IN-CAB DUST SWIRL BY ADDING A REAR PANEL
With a windshield & roof installed, turbulent air develops behind the cab. Add a rear panel to reduce dust intrusion from this swirl.



LOCK & RIDE **REAR PANEL - POLY** **TOP SELLER**

• Strong, .236" thick polycarbonate provides outstanding impact and scratch resistance

» 2879812 • \$339⁹⁹

570 '15-19, CREW 570-4 '15-19, 500 '17-19, EV '15-19, EV LHON '16-18

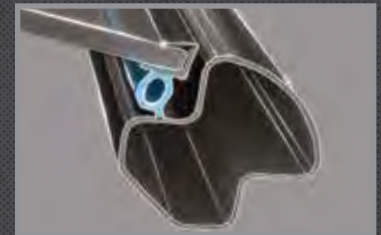

AIRTIGHT GASKET SEAL

RANGER® windshields feature a 360° gasket seal, preventing moisture and dust from entering the cab.

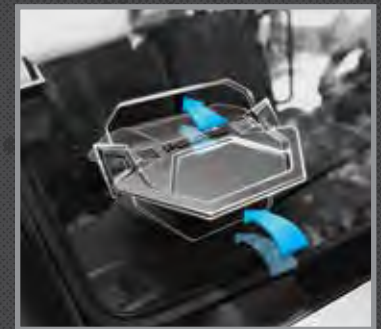

VENTING OPTIONS

Venting options are useful for controlling airflow into the cab. This allows you to regulate the temperature inside.



REVOLUTIONARY INSTALLATION

Every Lock & Ride® windshield utilizes a unique clamp that secures your windshield with the perfect amount of hold for rough trail conditions, yet still allows for easy, tool-less removal.

RANGER® 570 / 500 / EV

CONVENIENCE FEATURES

CAB SEAL SYSTEM

» 2 SEAT • 2880508 • \$159⁹⁹

570 '15-19, 500 '17-19, EV '15-19,
EV LHON '16-18

(INCLUDED WITH PREMIUM DOORS)

EPS SYSTEM (ELECTRIC POWER STEERING)

- Enjoy smooth, easy, precise, responsive automotive-quality power steering
- EPS provides a light steering feel in all situations, including low-speed maneuvering through challenging terrain

» 2879970 • \$1,739⁹⁹

570 '15-19, CREW 570-4 '15-19

HORN

» 2879273 • \$89⁹⁹

570 '15-19, CREW 570-4 '15-19, 500 '17-19,
EV '15-19, EV LHON '16-18

AUXILIARY BATTERY KIT

- Recommended to use up to two batteries

» 2880555 • \$409⁹⁹

EV '15-19, EV LHON '16-18

REMOTE GARAGE DOOR OPENER BY HOMELINK®

» 2882082 • \$209⁹⁹

570 '15-19, CREW 570-4 '15-19, 500 '17-19,
EV '15-19, EV LHON '16-18

REVERSE WARNING ALERT

» 2880631 • \$109⁹⁹

570 '15-19, CREW 570-4 '15-19, 500 '17-19,
EV '15-19, EV LHON '16-18

SPEEDKEY®

» 2879988 • \$409⁹⁹

570 '15-19, CREW 570-4 '15-19, 500 '17-19

EV QUICK CHARGING SYSTEM

» 2880556 • \$809⁹⁹

EV '15-19, EV LHON '16-18



FIELD TESTED INTERIOR

ADD SUPERIOR ALL-WEATHER FUNCTIONALITY and comfort to your *RANGER*® with premium Polaris Engineered Accessories™. Keep warm on the coldest of days with a heater kit and improve visibility with a Windshield Wiper and Washer System or Large Rear View Mirror.



8-VENT HEATER & DEFROST SYSTEM

» 2879967 • \$1,069⁹⁹

570 '15-19, CREW 570-4 '15-19, 500 '17-19

⚠ Requires Battery Connection Cable



LARGE REAR VIEW MIRROR TOP SELLER

» 2879969 • \$89⁹⁹

570 '15-19, CREW 570-4 '15-19, 500 '17-19, EV '15-19,
EV LHON '16-18

WINDSHIELD WIPER & WASHER SYSTEM

- Use with Full Glass Windshield 2881783 only

» 2879968 • \$669⁹⁹

570 '15-19, CREW 570-4 '15-19, 500 '17-19, EV '15-19,
EV LHON '16-18

⚠ Requires Battery Connection Cable



PROTECT YOUR INVESTMENT

THE BEST WAY TO PROTECT your RANGER® is with durable, rugged Polaris® bumpers and guards. Engineered for heavy-duty use, these items are your best line of defense against unexpected encounters, and will keep you going strong even when on the toughest job.



2-SEAT & CREW

570/500

ROOFS & DOORS

GLASS WINDSHIELDS & REAR PANELS

POLY WINDSHIELDS & REAR PANELS

CAB COMFORT & PROTECTION

STORAGE

STANDARD BRUSHGUARDS

PERFECT FOR: **INCREASED PROTECTION AROUND LIGHTING AND FENDERS**



FRONT

1.25" DIAMETER
STEEL TUBE CONSTRUCTION



REAR

» FRONT • 2879973 • \$339⁹⁹ » REAR • 2879972 • \$269⁹⁹
570, '15-19, CREW 570-4 '15-19, 500 '17-19, EV '15-19, EV LHON '16-18



ROCK GUARDS WITH STEP

- Durable, stamped plate steel construction
- Provides additional protection for side of vehicle
- Integrated boot scraper helps keep interior clean

» 2 SEAT • 2879974 • \$209⁹⁹
570 '15-19, 500 '17-19, EV '15-19, EV LHON '16-18

RANGER® 570 / 500 / EV

THE RIGHT TOOLS GET MORE DONE

LOCK & RIDE

EXCLUSIVE AND AVAILABLE ON ALL POLARIS® VEHICLES, LOCK & RIDE® ACCESSORIES LET YOU QUICKLY CHANGE FROM ONE TASK TO ANOTHER WITH HUNDREDS OF OPTIONS.

WITH THE FLIP OF A LEVER, LOCK & RIDE® PLUNGERS USE OUTWARD PRESSURE TO EXPAND FOR A SECURE FIT.



TIP DOWN HEADACHE RACK

CARGO MAX SYSTEM

LOCK & RIDE

TIP-DOWN HEADACHE RACK

- Tip-down feature converts from rear cab protection to versatile bed rack
- Designed to accept multiple accessories, including coolers, storage boxes and more

» 2879976 • \$454⁹⁹

570 '15-19, CREW 570-4 '15-19, 500 '17-19, EV '15-19, EV LHON '16-18

LOCK & RIDE

CARGOMAX SYSTEM

- Comes standard with a support bar that ties the two sides together for a sturdy cargo hold
- Adjustable utility hooks provide more options for hanging tools, cords or gear
- Two sides and a support bar included

» 2882177 • \$669⁹⁹

570 '15-19, CREW 570-4 '15-19, 500 '17-19, EV '15-19, EV LHON '16-18



FIRE EXTINGUISHER HOLDER

- Quick-release strap allows for easy access

» 2882158 • \$114⁹⁹

570 '15-19, CREW 570-4 '15-19, 500 '17-19, EV '15-19, EV LHON '16-18



UNDER SEAT STORAGE BOX

» 2880046 • \$134⁹⁹

570 '15-19, CREW 570-4 '15-19, 500 '17-19, EV '15-19, EV LHON '16-18



BED EXTENDER/DIVIDER

LOCK & RIDE BED EXTENDER/DIVIDER

- Installs in any location in the box to secure any cargo
- Use it to extend or divide the cargo box

» 2879977 • \$339⁹⁹

570 '15-19, CREW 570-4 '15-19, 500 '17-19, EV '15-19, EV LHON '16-18

LOCK & RIDE CHAINSAW MOUNT

» 2879354 • \$179⁹⁹

570 '15-19, CREW 570-4 '15-19, 500 '17-19, EV '11-19, EV LHON '16-18



RIDE & REPAIR ESSENTIALS KIT

» 2881207 • \$134⁹⁹

ALL RANGER® MODELS

LOCK & RIDE D-RINGS

- The most versatile Lock & Ride® accessory - add as many as you need to secure your cargo with bungee cords or straps

» 2881545 • \$43⁹⁹

ALL RANGER® CARGO BOXES



LOCK & RIDE QUICKSTRAP

- The Quickest and Most Secure Way to Mount Polaris® Accessories

• Sold as a pair

» 2882187 • \$59⁹⁹

ALL COOLERS, RANGER® CARGO BOXES



NEW 1.5" X 15' 5,500 LB RATCHET STRAP

- Heavy duty webbing
- 2 Pack

» 2884031 • \$59⁹⁹



LOCK & RIDE® STORAGE BOX

LOCK & RIDE STORAGE BOX

- Rugged roto-molded construction locks for security and is water-resistant
- Low-profile design retains additional hauling capacity on top of vault
- Sliding drawer features foam padding and adjustable dividers
- Fits perfectly in the bed of your RANGER® pickup box or full-size SUV

» 2877033 • \$439⁹⁹

570 '15-19, CREW 570-4 '15-19, 500 '17-19, EV '15-19, EV LHON '16-18



LOCK & RIDE® TOOL RACK

LOCK & RIDE TOOL RACK

- Attach on the inside or outside of the cargo bed

» 2881533 • \$269⁹⁹

570 '15-19, CREW 570-4 '15-19, 500 '17-19, EV '11-19, EV LHON '16-18

CARGO BED MAT

- Non-slip surface to better secure loads
- Protect the cargo bed from scratches and scuffs
- Lifts out & is easy to clean
- Can be cut to access factory tie-down cleats

» 2881485 • \$134⁹⁹

570 '15-19, CREW 570-4 '15-19, 500 '17-19, EV '15-19, EV LHON '16-18



CARGO BED MAT



NEW 2" X 20' 10,000 LB RATCHET STRAP

- Heavy duty webbing

» 2884032 • \$43⁹⁹

ENGINEERED TO MAXIMIZE THE LIFE OF YOUR RIDE

All Polaris® fluids—from AGL to Demand Drive Fluid—are developed for your vehicle. Trust the only fluids perfectly engineered for your needs.



SPECIFIC NEEDS, **SPECIFIC OILS**

Polaris® invests millions in engine development, and part of that investment is making sure its lubricants—critical to engine performance—are the right formula for your specific engine. The amount of testing data and engineering resources used in developing Polaris® lubricants would overwhelm an aftermarket company. Therefore, the aftermarket must produce an oil to an industry-wide standard that must account for a variety of operating parameters.

PS-4 is designed specifically for Polaris® 4-cycle engines and has high film strength and wear protection under extreme loads and temperatures. Exclusive anti-wear additives protect engine parts with extra rust and corrosion protection.



Everything needed to change your oil! The correct filter & amount of oil for your vehicle.



PS-4 OIL CHANGE KIT (OIL & FILTER)		PS-4 EXTREME DUTY OIL CHANGE KIT (OIL & FILTER)
PART NUMBER	VEHICLE FITMENT	PART NUMBER
2202166	RANGER®/RZR®/SPORTSMAN® 570, TWIN 600, TWIN 700, TWIN 800	2879004
2879323	RANGER®, POLARIS GENERAL®, RZR® 900/1000, RS1	2879324
2877473	RANGER®/SPORTSMAN® 300-500, SPORTSMAN®/SCRAMBLER® 500/850/1000	2878924
2881696	RZR® TURBO	2881697



PS-4 FULL-SYNTHETIC OIL

PS-4 is optimal for ambient operating temperatures of -40° F to 100° F

- » 1 QT. • 2876244
- » 1 GAL. • 2876245
- » 16 GAL. • 2876247



PS-4 EXTREME-DUTY FULL-SYNTHETIC OIL

PS-4 Extreme Duty is optimal for ambient operating temperatures of 0° F to 130° F

- » 1 QT. • 2878920
- » 1 GAL. • 2878919
- » 16 GAL. • 2879003



ORV MAINTENANCE KIT

This convenient kit includes everything you need, in the correct fluid volumes, to properly maintain your drive train, and keep your vehicle in top operating condition.

- Includes: 1.5 qt.s AGL, 1 qt. Angle Drive Fluid, 1 pint Demand Drive Fluid, 1-3 oz. tube of All-Season Grease
- » 2880425



15W40 SUMMER DIESEL ENGINE OIL

- » 1 QT. • 2882515

5W40 ALL-SEASON DIESEL ENGINE OIL

- » 1 QT. • 2879832
- » 1 GAL. • 2881083



PROVEN PROTECTION

Powersports grade, full-synthetic base oils and proprietary additive systems outperform leading automotive and aftermarket engine oils in 75 hour severe duty engine testing.

PS-4 vs. AUTO OIL

**60% MORE
ROD END BEARING
WEAR PROTECTION
WITH PS-4**

PS-4



AUTO OIL



WORN & GROOVED

**+ 40% LESS CYLINDER WEAR
WITH PS-4**

**+ 30% LESS GRAFAL WEAR*
WITH PS-4**

*The purpose of the grafal coating is primarily to decrease friction and protect the piston from wear.



PS-4 RACE PROVEN PERFORMANCE

"The Baja 1000 is probably the toughest race in the world! In the brutal Baja desert there are so many things that can ruin your race it is great to know that Polaris Engineered™ Lubricants will never let us down.

We trust in the Polaris® products like the PS-4 motor oil to protect our machines vitals, they are a critical part of a winning formula."

**BILL SCHUELER
CREW CHIEF JAGGED X**

MAINTENANCE FLUIDS



OIL

Maximum protection for your 4-cycle engine. Exclusive anti-wear additives protect your engine and extend the life of engine components.

Change every 100 hours, 6 months or 500 miles (800 km).



AGL

Extreme pressure additives protect gears, drive chain, and bearings from scoring and wear. Unlike typical gear case oils, AGL's unique viscosity range allows instant flow and film protection in extreme cold or high heat environments.

Change every 100 hours, 12 months or 1000 miles (1600 km).

- » 1 QT. • 2878068
- » 1 GAL. • 2878069
- » 2.5 GAL. • 2878070
- » 55 GAL. • 2879594



U-JOINT GREASE

A heavy-duty lubricant formulated with molybdenum disulfide to accept the high shock applications of Polaris' ATV shaft drive universal joints.

Add every 50 hours, 3 months or 500 miles (800km).

- » 3 QZ. • 2871515
- » 14 OZ. • 2871551



DOT 4 BRAKE FLUID

A high-quality brake fluid designed for use in Polaris' hydraulic brakes. Superior high-temp characteristics plus anti-corrosive additives extend the life of brake system components and provide consistent, positive braking.

Change every 200 hours, 2000 miles (3200 km) or every 2 years.

- » 12 OZ. • 2872189



ANTI-FREEZE

Organic acid technologies to prevent corrosion on metal components, eliminate scaling, and maximize cooling system performance.

Change every 60 months.

- » 1 QT. • 2880514
- » 1 GAL. • 2880513
- » 55 GAL. • 2880512



DEMAND DRIVE FLUID

Provides positive 4WD engagement in extreme cold or high heat conditions. Unique friction additives protect internal components under heavy loads and promote positive engagement.

Change every 100 hours or yearly.

- » 1 QT. • 2877922
- » 2.5 GAL. • 2877923



PREMIUM GAS SHOCK OIL

- » 1 QT. • 2870995
 - » 2.5 GAL. • 2872279
- FOX® REBUILDABLE SHOCKS

10WT GAS SHOCK OIL

- » 1 QT. • 2874124
- WALKER EVANS® REBUILDABLE SHOCKS

CHAIN LUBRICANT

- » 16 OZ. AEROSOL 2872348

ALL-SEASON GREASE TUBE

- » 3 OZ. • 2871322
- » 14 OZ. • 2871423

ANGLE DRIVE FLUID

- » 1 QT. • 2876160
 - » 2.5 GAL. • 2872276
- SPORTSMAN®, RANGER®, RZR® ANGLE DRIVE GEAR CASE SYSTEMS

CARBON CLEAN

Prevents ethanol corrosion, stabilizes fuel, and cleans fuel injectors, piston ring lands, intake systems, and combustion chambers. Helps maintain peak HP and improves fuel economy.

- » 12 OZ. • 2881413

ADVANCED FUEL TREATMENT

Prevents ethanol corrosion and stabilizes fuel for up to 2 years. Dual-antioxidant formula protects against gum and varnish for easy starting.

- » 12 OZ. • 2881416
- » 2.5 GAL. • 2881417

LUBRICANT ACCESSORIES



GREASE GUN KIT

- » 2871312 • \$44⁹⁹
- FITS 2871322 ALL-SEASON AND 2871322 U-JOINT 3 OZ.



2D BATTERY-OPERATED SIPHON PUMP

- Liquid transfer pumps 5-6 quarts/min suctioning power
 - Use with gas, water, oil, and other non-corrosive liquids
- » 2830513 • \$20⁹⁹



FLEX SPOUT

- Convenient easy pour flex spout fits all Polaris® quart, gallon, and 2.5 gallon bottles

- » 2871285 • \$3⁹⁹



PUMP

- Attaches to 1- or 2.5-gallon Bottle for easy, no-drip dispensing

- » 2870465 • \$9⁹⁹

TIRE SEALANT

HOW IT WORKS

Tire sealant remains liquefied inside your tire until a leak develops in the tire or wheel.

Once a leak occurs, the tire sealant rushes out of the tire and quickly creates a permanent solid plug.

The plug maintains the pressure of the tire so you can continue your ride.

PREMIUM TIRE SEALANT

- Instantly seals and repairs rim, bead leaks, and punctures up to 1/4" on standard tires, and 3/4" on heavy ply tires
- Helps maintain air pressure for the life of the tire
- Helps seal the tire bead against the wheel
- 100% water soluble for easy cleanup
- Will not rust, corrode, or pit wheels
- Creates permanent repair
- Remains fluid and effective in temperatures down to -45° F
- Easily installed through existing tire valve stem with valve core removed

» 32 OZ. • 2830484 • \$23⁹⁹

» 1 GALLON • 2830485 • \$82⁹⁹

» 5 GALLON • 2830486 • \$346⁹⁹

» 5 GALLON PUMP • 2830487 • \$154⁹⁹

» 55 GALLON • 2830489

» 275 GALLON • 2830488



24 X 7 COVERAGE | BE PREPARED FOR ANYTHING

NOTHING CAN STOP YOU.

COVERAGE WHEN YOU NEED IT.

FIX ON THE GO | TEMPORARY COVERAGE

CV BOOT REPAIR KIT*

- A quick trail side fix to increase trail time.
- The flexible and durable boot material expands over a cone tool for CV boot repairs, without disassembling CV axles.
- Universal fit - works as a temporary fix for most powersports axles.
- All components fit inside the cone, and a cover is provided for compact durable storage.
- Easily fits in a cargo box, attached to the roll cage, in the glovebox, or many other storage locations.



Items shown are contained inside cone

UTV CV BOOT REPAIR KIT

• Kit includes the following items:

- (1) Expandable XL CV Boot
 - (1) Reusable Cone Tool
 - (2) CV Boot Clamps
 - (1) Tube of Silicone Lube
 - (1) Grease Packet
 - (1) Cone Cover
- » 2830526 • \$35⁹⁹

UTV TRAIL BOOT ONLY

» 2830527 • \$17⁹⁹

ATV

- » CV REPAIR KIT 2830528 • \$31⁹⁹
- » TRAIL BOOT ONLY 2830529 • \$17⁹⁹

SEE HOW THE CV BOOT REPAIR KIT WORKS AT POLARIS.COM/MAINTENANCE-VIDEOS



HOW TO INSTALL

- Remove wheel and axle nut
- Remove brake caliper, hub, tie rod, & upper & lower ball joints
- Remove old boot & clean joint
- Spread silicone lube on entire cone tool. Slide boot over cone tool, large end first. See package for outer boot instructions.
- Empty the bag of grease into the CV joint/boot, clean sealing points & install clamps
- Reassemble tie rod, ball joints, brake caliper, axle nut, tire & wheel

Refer to your owner's manual for further instructions and torque specifications.

*Designed for temporary CV boot repair. Purchase the OEM CV Boot for a permanent repair.

FOR THE LIFE OF YOUR RIDE

AIR FILTERS

Critical to engine performance and reliability. A clogged air filter can restrict air flow to the engine leading to reduced engine performance. Dirt and debris ingestion can damage the engine leading to reduced engine life or catastrophic failure. Polaris® recommends changing the vehicle's air filter at the specified intervals outlined in the owner's manual, which may be shorter if your vehicle is subject to severe conditions.

BRAKE PADS

Check your brakes if you are close to the recommended service interval, hear grinding when applying the brakes, your vehicle is taking longer to stop or if you have to apply more pressure to your pedal to engage the brakes. Check the brake discs for signs of cracks, excessive corrosion or warping.

If the brake pads are contaminated with oils or grease (petroleum products), brake pads have to be discarded and replaced.

Discs need to be cleaned with brake cleaner or alcohol based cleaner only.



MAINTENANCE SCHEDULE

25 HRS/400 km

BREAK-IN MAINTENANCE

ENGINE OIL:
CHANGE

GENERAL LUBRICATION:
ALL FITTINGS, PIVOTS, CABLES, ETC.

AIR FILTER:
INSPECT & CLEAN
REPLACE AS NEEDED

EXHAUST SYSTEM:
INSPECT & CLEAN
INSPECT FOR LEAKAGE OR CARBON BUILD UP AT JOINTS

INSPECT & CLEAN SCREEN TYPE SPARK ARRESTOR

50 HRS/800 km

6 MONTHS

EXHAUST SYSTEM:
INSPECT & CLEAN
INSPECT FOR LEAKAGE OR CARBON BUILD UP AT JOINTS
INSPECT & CLEAN SCREEN TYPE SPARK ARRESTOR

GENERAL LUBRICATION:
ALL FITTINGS, PIVOTS, CABLES, ETC.

DRIVE BELT:
INSPECT & ADJUST
REPLACE AS NEEDED

100 HRS/1600 km

12 MONTHS

ENGINE OIL:
CHANGE

DRIVE BELT:
INSPECT & ADJUST
REPLACE AS NEEDED

TRANSMISSION FLUID:
CHANGE

EXHAUST SYSTEM:
INSPECT & CLEAN
INSPECT FOR LEAKAGE OR CARBON BUILD UP AT JOINTS

INSPECT & CLEAN SCREEN TYPE SPARK ARRESTOR

150 HRS/2400 km

18 MONTHS

ENGINE OIL:
CHANGE

BATTERY:
TEST, CLEAN, & CHECK FLUID LEVEL
REPLACE AS NEEDED

DRIVE BELT:
INSPECT & ADJUST
REPLACE AS NEEDED

TIRES:
INSPECT CONDITION & PRESSURE

EXHAUST SYSTEM:
INSPECT & CLEAN
INSPECT FOR LEAKAGE OR CARBON BUILD UP AT JOINTS

INSPECT & CLEAN SCREEN TYPE SPARK ARRESTOR

THE KEY TO KEEPING YOUR POLARIS® OFF-ROAD VEHICLE PERFORMING as well as the day you brought it home is proper maintenance. Items like belts, filters, and batteries represent only a few of these critical items engineered specifically by Polaris®.



DRIVE BELTS

Polaris Engineered™ belts deliver unmatched performance for your off-road vehicle. Developed and tested on all our engines for all environments and conditions. Check your belt for delamination, hour glassing and glazing.

OIL FILTERS

Change oil filters with every oil change to provide the best protection for your engine. Superior engine protection keeps your engine operating at peak performance. Be sure to follow the suggested service intervals for oil/oil filter changes.

BATTERIES

Never leave a battery unattended during the storage season. To ensure your battery maintains its level of charge when unused for extended periods of time or during freezing weather, the battery should be connected to a BatteryMINDER™. Be sure to check for corrosion from the terminals to the ends of the cables.

MAINTENANCE TIP

BREAK-IN PERIOD

The break-in period for your new *RANGER* is the first 25 hours of operation, or the time it takes to use the first two tanks of fuel. No single action on your part is as important as a proper break-in period. Careful treatment of a new engine will result in more efficient performance and longer life for the engine. Perform the listed procedures carefully.

NOTICE: Excessive heat build-up during the first three hours of operation will damage close-fitted engine parts. Do not operate at full throttle or high speeds for extended periods during the first three hours of use.

**SEE OUR LATEST MAINTENANCE TIPS
AT [POLARIS.COM/MAINTENANCE-VIDEOS](https://www.polaris.com/maintenance-videos)**



200 HRS/3200 km

24 MONTHS

ENGINE OIL:
CHANGE

**BRAKE PADS
& FLUID:**
INSPECT & CLEAN
REPLACE AS NEEDED

SPARK PLUGS:
INSPECT
REPLACE AS NEEDED

EXHAUST SYSTEM:
INSPECT & CLEAN
INSPECT FOR LEAKAGE OR
CARBON BUILD UP AT JOINTS

INSPECT & CLEAN SCREEN
TYPE SPARK ARRESTOR

350 HRS/4020 km

30 MONTHS

ENGINE OIL:
CHANGE

BATTERY:
TEST, CLEAN, &
CHECK FLUID LEVEL
REPLACE AS NEEDED

DRIVE BELT:
INSPECT & ADJUST
REPLACE AS NEEDED

**GENERAL
LUBRICATION:**
ALL FITTINGS, PIVOTS,
CABLES, ETC.

EXHAUST SYSTEM:
INSPECT & CLEAN
INSPECT FOR LEAKAGE OR
CARBON BUILD UP AT JOINTS

INSPECT & CLEAN SCREEN
TYPE SPARK ARRESTOR

500 HRS/8045 km

36 MONTHS

ENGINE OIL:
CHANGE

AIR FILTER:
INSPECT, CLEAN
REPLACE AS NEEDED

COOLANT:
CHECK LEVEL
REPLACE EVERY 2 YEARS

GEARCASES:
CHECK OIL LEVEL

EXHAUST SYSTEM:
INSPECT & CLEAN
INSPECT FOR LEAKAGE OR
CARBON BUILD UP AT JOINTS

INSPECT & CLEAN SCREEN
TYPE SPARK ARRESTOR

**CHECK YOUR
OWNER'S MANUAL
FOR ADDITIONAL
RECOMMENDED
SERVICE ITEMS
AND VEHICLE-
SPECIFIC TIMING**

SERVICE PARTS

Polaris Engineered™ service parts deliver unmatched performance and fit for your off-road vehicle.

All service parts are developed and tested for your vehicle. **Half shafts, bushings, bearings, decals, side panels, electrical components, and clutching components** are the same parts that are manufactured on the factory lines for each specific vehicle. This ensures it doesn't merely fit your vehicle - it outperforms your expectations!

**SHOP FOR SERVICE PARTS ONLINE
OR VISIT YOUR POLARIS® DEALER.**

*CHECK OUT OUR PARTS FINDER ON POLARIS.COM
FOR EASY PARTS LOOK-UP, PARTS IDENTIFICATION, VIEWS OF ASSEMBLIES & MORE!*



STEP 1

Visit **Polaris.com/RANGER**
Click "**Parts & Service**" tab
Click "**Service Parts**"



STEP 2

Enter **vehicle year/model** or
shop by **part number**

OVER
100,000
PARTS
AVAILABLE!



STEP 3

Clearly see what parts are required and **order**

Assembly
DRIVE TRAIN, FRONT HALF SHAFT - R17RTM9AMBM (701543)

R17RTM9 ROR 1000 XP ALL OPTIONS (2017) (R33)

Zoom In **Zoom Out**

Tag	Part #	Description	Price	Qty	
1	1033585	ASM-HALF SHAFT, FRONT (INCL ALL)	\$240.99	2	Add
2	3235775	ASM OUTER JOINT	\$704.99	1	Add
3	3235776	K-BOOT OUTER	\$45.99	1	Add
4	3235904	BOOT KIT (SP ONLY)	\$29.99	1	Add
5	3235905	INNER JOINT (SP ONLY)	\$114.99	1	Add
6	3235906	ORCLP (SP ONLY)	\$5.29	1	Add
7	3235907	ORCLP (SP ONLY)	\$5.29	1	Add
8	3235908	SHAFT-DRIVE, SERVICE	\$54.99	1	Add



POLARIS

POWER[®] GENERATORS



POWERFUL, PORTABLE, DURABLE.

Portable, quiet power great for remote locations. Tested to be tough, these generators are an excellent addition to any trip.

WHICH GENERATOR FITS YOUR NEEDS?

1 Add up the running watts of everything you might power at the same time.

2 Pick the device with the highest running watts and add its starting watts to the previous total.

3 Select a generator with a slightly higher wattage.

	Startup Wattage	Running Wattage
55" LCD TV	0	150
CROCK POT	0	200
RADIO	0	50-200
LAPTOP	0	200-250
625W MICROWAVE	0	625
FRIDGE OR FREEZER	700	700
COFFEE MAKER	1300	800
SUMP PUMP: 1/3 HP	1300	800
BLENDER	1000	1000
ELECTRIC GRIDDLE	0	1500
7 1/4" CIRCULAR SAW	1700	1400
AIR CONDITIONER	1500	1500

POLARIS POWER[®] INVERTER GENERATORS



P1000i

1000 WATT
PORTABLE / QUIET

- Dual handles and only 36.4 lbs.
 - Connect two units together for even more output
 - Quieter than casual conversation (54db @ 25%)
 - Up to 10 hours on 1 tank of gas
- » P136DGANA • **\$659⁹⁹**



P2000i

2000 WATT
VERSATILE / LIGHTWEIGHT

- Dual handles and only 53.3 lbs.
 - Connect two units together for even more output
 - Quieter than casual conversation (54db @ 25%)
 - Up to 10 hours on 1 tank of gas
- » P136DGBNA • **\$959⁹⁹**



P3000iE

3000 WATT
ROBUST / ELECTRIC START

- Locking 360 degree pivoting wheels
 - Easy electric start for minimal effort
 - Quieter than casual conversation (56db @ 25%)
 - Up to 21.5 hours on 3.5 gallons of gas
- » P136DGCNA • **\$1,899⁹⁹**

PORTABLE POWER



POLARIS® FLEX JUMPSTARTER

- 12,000 mAh capacity. Two 5V/2.1A USB outputs, 200-lumen flashlight, and a digital battery life monitor. Includes storage case, smart jumper cables, car charger, wall charger, and user guide.
 - 1-year limited warranty.
 - Jumpstart any engine up to 6.4L. The Polaris® Flex Jumpstarter is small enough to be stored in your glovebox and holds its charge so you can count on it when it's needed.
- » 2830495 • **\$143⁹⁹**

GENERATOR ACCESSORIES



POLARIS POWER® COLD WEATHER KIT

- Ensure smooth running of your Polaris® Generator in sub-zero temperatures
 - Prevents ice blockage in the crankcase breather tube, which may lead to operational issues including oil leakage
 - Installation required, no need to disconnect for warm weather operation
 - Exclusively designed for use with Polaris® P1000i & P2000i inverter generators
- » 2881433 • **\$119⁹⁹**



POLARIS POWER® TIE-DOWN LEADS

- Secure your Polaris Power® Generator by inserting the Lock & Ride™ Tie Down Leads into the handle and running a strap across to tie down the generator
 - Secures Lock & Ride™ accepting gear
 - Safely provides a point for 1" wide tie-down strap
- » 2880959 • **\$16⁹⁹**



POLARIS POWER® CABLE KIT

- Use a parallel cable kit to easily connect two Polaris Power® generators together to increase the total power available to a load
- » 3410281 • **\$169⁹⁹**



POLARIS POWER® GENERATOR OIL

- Corrosion inhibitors protect against rust and oxidation during long-term storage
- » 1 QUART • 2879383



POLARIS POWER® GENERATOR STORAGE COVERS

- Keep your generator looking like new with a strong, durable cover that is resistant to mold, mildew, tears, and abrasions

» 1000 WATT COVER • 2686441
\$34⁹⁹

» 2000 WATT COVER • 2686442
\$39⁹⁹

» 3000 WATT COVER • 2686443
\$44⁹⁹

BatteryMINDER®

ENSURE YOUR RIDE IS READY WHEN YOU ARE!

- Add years of capacity, power and range to new and older batteries, regardless of type or brand
- Never over or under charged in any temperature
- Leave your vehicle connected for months and return to fully charged and conditioned batteries
- Recover older-weak batteries that would normally need to be replaced
- Charge and maintain extra-backup batteries as well as those in your vehicle
- Automatic turn-on, sleeps while keeping your batteries at full-charge
- Easy Push-Button selector to change battery type or time



	BatteryMINDER® 2012 AGM 2 AMP	BatteryMINDER® 1510 1.5 AMP	BatteryMINDER® 1.5 AMP CONVERTIBLE
PRICE	\$119 ⁹⁹	\$77 ⁹⁹	\$89 ⁹⁹
PART NUMBER	2830438	2830404	2830511
VOLTAGE	12	12	12
CHARGING CURRENT	2AMP	1.5AMP	1.5AMP
OVERCHARGE PROTECTION	Yes	Yes	Yes
BATTERIES MAINTAINED AT ONE TIME	6	4	4
WARRANTY	5 Years	10 Years	5 Years
BATTERY COMPATIBILITY	12 Volt Sealed AGM Lead-Acid	12 Volt flooded (filler cap) and sealed maintenance free batteries	12 Volt flooded (filler cap) and sealed maintenance free batteries
COMES WITH	• Non-fused battery clip cord set with Quick Connector	• Ambient temperature sensor (installed) • 12ft. power cord • Battery clip cord set with Quick Connector • Optional Permanent Mounting Tab	• Auto-Temp compensation sensor (installed) • Optional permanent mounting brackets & screws • Battery clips (fully-insulated, aircraft grade, 15A replaceable fuse) • Ring terminal assembly with 15A replaceable fuse
KEY FEATURES	Designed for high performance specialty AGM sealed batteries	Easy to use, economical	Convertible on-vehicle or bench top use

BATTERY MAINTENANCE TIPS

Extend your battery life with a BatteryMINDER® and these tips.

1. Store batteries in a cool, dry location.
2. Check that the battery connections are tight. Cables should not be able to be rotated or shifted by hand.
3. If your battery has a drain tube, make sure it is free of clogs.
4. Clean your battery - use a soft brush to scrub the top of the battery. Use baking soda to remove grease.
5. Connect a BatteryMINDER® after using your vehicle even if the vehicle is in regular use.

BatteryMINDER® ACCESSORIES



**BatteryMINDER®
VPP-12:12/24 VOLT
VEHICLE POWER PLUG**

- Allows easy connection to vehicle's battery through lighter or 12/24V power port with replaceable 15 amp fuse.

» 2830518 • \$12⁰⁰



**BatteryMINDER®
12' EXTENSION
CABLE**

- Made with heavy-duty 16 gauge black zip cord featuring automotive SAE bullet connectors

» 2830410 • \$15⁹⁹



**BatteryMINDER®
MULTI-BATTERY
SPLITTER**

- A simple, safe, and affordable way to connect two batteries simultaneously for easy battery maintenance
- Includes a set of ring terminals

» 2830409 • \$29⁹⁹



**BatteryMINDER®
RING TERMINAL KIT**

- Features 24-inch long 18-gauge wire
- Plug has standard 5/16" negative and 3/8" positive terminals
- Replaceable 15 amp in-line fuse for circuit protection
- SAE quick connector and cap

» 2830437 • \$11⁹⁹



**BatteryMINDER®
EZ CONNECT**

- Allows for quick and easy connecting and disconnecting of your BatteryMINDER®
- Includes a set of ring terminals

» 2830411 • \$39⁹⁹

LIFT IT SECURELY

LIFT IT SAFELY

POLARIS® VEHICLE LIFT

- Get fast, easy access to the underside of your vehicle
- Manual and pneumatic operation available
- Raises vehicle up to 32" to make repairs and maintenance faster and easier

» 1200 LBS • 2830424 • **\$839⁹⁹**

LIFT ATTACHMENTS

- Add the appropriate attachment to use your lift for all your off-road vehicles

» ATV/POLARIS ACE® • 2830427 • **\$199⁹⁹**

» SNOWMOBILE • 2830426 • **\$199⁹⁹**



POLARIS® X3 CREEPER

- Three positions: flat, 45-degree angle or seated work stool
- Helps you perform any repair with ease
- Stay dry and warm away from cold, wet cement floors
- Easily stores away when not in use

» BLACK • 2830429 • **\$179⁹⁹**



SHOP ACCESSORIES



POLARIS® MAGNETIC PARTS TRAY

» SILVER • 2830432 • **\$14⁹⁹**



POLARIS® 33" TELESCOPIC MAGNET

» BLACK • 2830435 • **\$5⁹⁹**



POLARIS® 12" HI-TORQUE RATCHETING DRIVER

» BLACK / BLUE • 2830434 • **\$23⁹⁹**



POLARIS® LED POCKET FLASHLIGHT

» BLACK • 2830436 • **\$31⁹⁹**

KEEP IT CLEAN

CLEAN YOUR VEHICLE

PRE-TREAT

MUD SHIELD® PRE-TREATMENT

- Inhibits the adhesion of dirt, mud, and snow, making cleaning your vehicle faster and easier.

› 16 OZ. AEROSOL • 2830229 • \$13⁹⁹

NEVER RUST SPRAY®

- Synthetic formula highly resistant to water protects against rust and corrosion while lubricating metal surfaces.

› 16 OZ. AEROSOL • 2830230 • \$14⁹⁹



PROFESSIONAL GRADE CLEANERS

CLEAN

XP WASH®

- Foaming, highly-concentrated wash easily removes the most stubborn and intense dirt build-up.

› 32 OZ. • 2830225 • \$14⁹⁹

XP SPRAY WASH®

- Effortless biodegradable, high-performance wash ideal for removing dirt, oils and carbon—simply spray on, spray off and go.

› 32 OZ. • 2830224 • \$18⁹⁹

ALL-PURPOSE CLEANER

- Professional grade, non-streak, foam formula cuts through grease, dirt and film leaving an invisible, dirt-resistant barrier for long-lasting results.

› 16 OZ. • 2830227 • \$13⁹⁹

GLASS CLEANER

- Heavy-duty foam non-streak formula cuts through grease, dirt, dried bugs and film leaving a crystal clear dirt-resistant barrier for long-lasting results.

› 16 OZ. • 2830445 • \$5⁹⁹

VEHICLE

VEHICLE & EQUIPMENT WASH

- Concentrated professional grade formula powers through vehicle buildup, dirt and grease with a spot-free rinse. Treat up to 32 gals. Biodegradable product.

› 1 GAL. • 2830417 • \$19⁹⁹

› 5 GAL. • 2830422 • \$69⁹⁹

SHINE

POLARIS® POLISH

- Easy protection and shine—spray on, wipe off, and go. For ideal use on painted and plastic surfaces. Contains carnauba wax.

› 12 OZ. • 2830228 • \$11⁹⁹

INSTANT SHINE & DETAILER

- Spray and wipe formula—cleans, polishes, and protects plastic and painted surfaces.

› 16 OZ. • 2830226 • \$12⁹⁹

SHOP

ALL-PURPOSE CLEANER PLUS

- Professional-grade formula removes built-up stains from shop floors, work benches, and other hard surfaces. VOC-free, environmentally-friendly, and biodegradable.

› 1 GAL. • 2830414 • \$19⁹⁹

› 5 GAL. • 2830416 • \$69⁹⁹

CLEAN YOUR SHOP

TOWELS

POLARIS® SHOP TOWELS

› 200 CT WITH DISPENSER
2830402 • \$26⁹⁹

› 200 CT REFILL • 2830403 • \$18⁹⁹

› 64 CT REFILL • 2830440 • \$5⁹⁹



POLARIS® HEAVY-DUTY SCRUBBER WIPES

› 90 CT • 2830441 • \$29⁹⁹



HD CLEANER & DEGREASER

- Professional-grade, biodegradable, high-foaming formula dissolves and removes tough stains and soils.

› 1 GAL. • 2830418 • \$23⁹⁹

› 5 GAL. • 2830420 • \$95⁹⁹

BRING IT EVERYWHERE

TRAILERING



RAMP PRO BY CALIBER®

- Designed for ATVs and UTVs up to 50" wide
- Integrated grip glides for ultimate traction
- Folding sides for easy transportation & storing
- » 52" x 90" • 2883005 • \$519⁹⁹



ALUMINUM ARCHED LOADING RAMPS

- » 76" x 12" • 2,000 lb • 2875384 • \$279⁹⁹
- » 88" x 12" • 3,000 lb • 2875386 • \$459⁹⁹

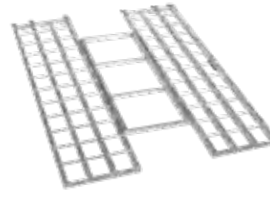

LIGHTWEIGHT TRI-FOLD RAMPS

- Ramp folds up for transport
- Capacity for up to 1,500 lb (680.7 kg)
- Safety straps included
- » 72" x 51" • 2875385 • \$309⁹⁹
- » 82" x 51" • 2875860 • \$369⁹⁹



FOLDING ALUMINUM ARCHED RAMPS

- Ramp folds up for transport
- Capacity up to 3,000 lb (1360.8 kg)
- Safety straps included
- » 88" x 12" • 2875387 • \$379⁹⁹

HITCHES

3:1 HITCHES

VERSATILE 3 IN 1 FUNCTIONALITY

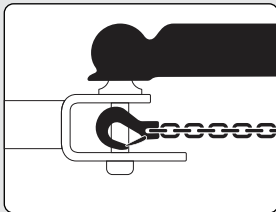

BALL

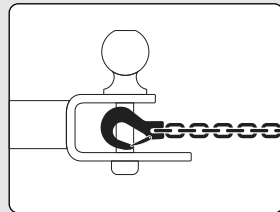

HOOK

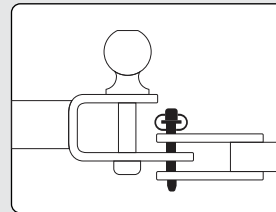

PIN

- Ball, pin and hook design
- Durable steel construction
- Rust resistant, black powder coated finish
- Removable ball
- HD 5/8" pin and clip



NEW HITCH WITH 2" BALL

- » 2" x 2" RECEIVER 2830522 • \$47⁹⁵
- » 1 1/4" x 1 1/4" RECEIVER 2830523 • \$47⁹⁵



NEW 1 7/8" BALL

- 1 7/8" replacement ball for hitch
- Designed to work with 3:1 Hitch
- » 2830524 • \$11⁹⁵



2" HITCH BALL MOUNT

- » 2" RECEIVER TONGUE 2875320 • \$59⁹⁹
- » FRONT HITCH RECEIVER 2878846 • \$169⁹⁹



TRAILER BALL 3/4" SHANK

- » 2" BALL • 2877603 • \$18⁹⁹
- » 1 7/8" BALL • 2877602 • \$18⁹⁹

STRAPS

NEW 2" X 30' RECOVERY STRAP

- Heavy duty webbing
- 18,000 Lb. Breaking Strength / 9,000 Lb. Max. Vehicle Weight
- Built in strap wrap - easy storage
- Loops sewn in to webbing
- 1 Strapbag
- » 2884033 • \$74⁹⁹



NEW 1.5" X 15' 5,500 LB RATCHET STRAP

- Heavy duty webbing
- 5,500 Lb. Maximum Load / 1,833 Lb. Working Load
- 2 Pack
- » 2884031 • \$59⁹⁹



NEW 2" X 20' 10,000 LB RATCHET STRAP

- Heavy duty webbing
- 10,000 Lb. Maximum Load / 3,300 Lb. Working Load
- Floating D-Rings
- Double J-Hooks
- » 2884032 • \$43⁹⁹



SHOCK STRAPS

- 1.5" 3000 lb breaking strength
- Keeps tension on tie-down straps to secure load
- 2 Pack
- » 2883296 • \$109⁹⁹
- » 2883295 • \$94⁹⁹

COVERS

2-SEAT & CREW TRAILERING COVERS

- » 2880632 • 570/500/EV • \$409⁹⁹
570 '15-19, 500 '17-19, EV '15-19, EV LHON '16-18
- » 2880633 • 570 CREW • \$519⁹⁹
CREW 570-4 '15-19



3-SEAT & CREW TRAILERING COVERS

- » 2883419 • XP 1000 • \$409⁹⁹
XP 1000 '18-19
- » 2879407-067 • XP 900/DIESEL • \$409⁹⁹
XP 900 '13-19, DIESEL '15-18
- » 2883840 • CREW XP 1000/900/DIESEL • \$409⁹⁹
CREW XP 1000 '17-19, CREW XP 900 '14-19, CREW DIESEL '15-18

**KINGPIN DIRT
509° GOGGLE**

- Quick change lens & triple layer foam
- Anti-fog & anti scratch
- » ONE SIZE • \$74⁹⁹
2868671 • LIME
2868668 • ORANGE

**ORV RIDING
JERSEY**

- » S-3XL • \$39⁹⁹
2868711 • LIME
2867941 • PINK
2867942 • RED

 **COOL**

BE PREPARED FOR ANYTHING NATURE

COOLING SHIRTS

- 100% Poly, chemical-free patented fabric from CoolCore™
- Moisture wicking to keep you dry and cool
- UPF 45+
- » S-3XL • \$59⁹⁹
- » MEN'S
2868753 • GRAY
- » WOMEN'S
2868755 • GRAY/PINK



 **COOL**

NEW

RAIN SUIT

- Lightweight
- Waterproof
- Packs small
- Removable hood
- YKK® zippers
- » JACKET • 2869527
S-3XL • \$144⁹⁹
- » PANT • 2869528
S-3XL • \$109⁹⁹



 **DRY**

SOFTSHELL JACKET

- Lined with 280 grams of fleece for warmth
- Removable hood
- Armpit zips for venting
- » S-3XL • **\$169** ⁹⁹

- » MEN'S
2869919 • BLUE/ORANGE
2869918 • BLACK
- » WOMEN'S
2869921 • CORAL
2869920 • BLACK



WARM



FIND YOUR PERFECT HELMET!

RIDE SAFE - OUR HELMETS ARE DOT/ECE CERTIFIED



509[®] ALTITUDE CARBON HELMET

- Durable, ultra lightweight, Carbon Fiber
- Full carbon fiber shell
- 1100 grams

- » S-4XL • **\$519** ⁹⁹
- 2867814 • MATTE BLACK
- 2867815 • GLOSS BLACK



509[®] ALTITUDE HELMET

- Stylish, Lightweight with 509 Fit and Finish
- Thermoplastic poly alloy out shell
- 1260 grams

- » S-4XL • **\$299** ⁹⁹
- 2868539 • LIME
- 2867820 • BLUE
- 2867818 • ORANGE
- 2867819 • RED
- 2867817 • GRAY



TENACITY HELMET

- All the style and protection in our most affordable helmet
- Injection molded plastic
- 1450 grams

- » XS-3XL • **\$144** ⁹⁹
- 2868624 • PINK GLOSS
- 2868620 • BLACK/GRAY
- 2868622 • BLUE GLOSS
- 2868619 • BLACK MATTE
- 2868623 • RED GLOSS
- 2868621 • LIME GLOSS

THROWS AT YOU

STAY WARM AND CHARGE YOUR PHONE

NEW HEATED VEST

- Three heat settings for changing weather
- Down-proof material
- Removable hood
- Powered by a small rechargeable battery (included)
- Battery can be recharged via USB or any 12V outlet
- Charge a cell phone with the rechargeable battery
- Machine washable

- » MEN'S • S-3XL • **\$269** ⁹⁹
- 2869924 • DARK GRAY
- » WOMEN'S • S-3XL • **\$284** ⁹⁹
- 2869923 • DARK GRAY

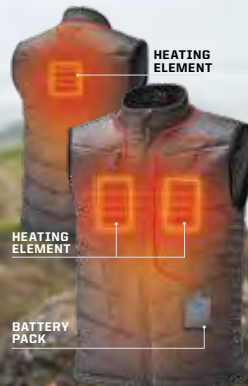

WARM

PROTECT YOUR HANDS

OFF-ROAD RIDING GLOVES

- As seen in images at left

- » S-3XL • **\$32** ⁹⁹
- 2867937 • PINK
- 2867933 • GRAY
- 2868712 • BLUE/LIME
- 2867936 • RED
- 2867935 • ORANGE
- 2867934 • BLUE



**WOMEN'S
ASYMMETRICAL
HOODIE**

» \$74⁹⁹ • S-3XL
BLACK • 2868597

**WOMEN'S
ROSEAU TEE**

» \$32⁹⁹ • S-3XL
GRAY FROST • 2869559
BLACK • 2868586



**MEN'S RETRO
LOGO HOODIE**

» \$74⁹⁹ • S-3XL
BLACK • 2869549
CHARCOAL/LIME • 2868578
GRAY/ORANGE • 2868577

MEN'S RETRO CAP

» \$32⁹⁹ • ONE SIZE
NAVY/LIME • 2869543

**MEN'S
ROSEAU HOODIE**

» \$74⁹⁹ • S-3XL
CHARCOAL HEATHER • 2869553
NAVY HEATHER • 2868575
OLIVE HEATHER • 2868576



**CAMO WATER
BOTTLE**

» 2867962 • \$26⁹⁹

**CAMO COFFEE
TRAVEL MUG**

» 2867961 • \$32⁹⁹

**CAMO BOTTLE
KOOZIE**

» 2867964 • \$14⁹⁹

**CAMO CAN
KOOZIE**

» 2867963 • \$8⁹⁹

**CAMO
STEERING
WHEEL COVER**

» 2868663 • \$19⁹⁹

**CAMO BOTTLE
OPENER** NOT SHOWN

» 2867965 • \$14⁹⁹



**WOMEN'S CAMO
HOODIE**

» \$74⁹⁹ • S-3XL
CAMO/PINK • 2867898

**MEN'S CAMO
TECH FULL ZIP**

» \$69⁹⁹ • S-3XL
CAMO • 2869590



**MEN'S POLARIS®
RANGER CAP**

» \$24⁹⁹ • GRAY
S/M • 2869604
L/XL • 2869605

**MEN'S POLARIS®
RANGER TEE**

» \$32⁹⁹ • S-3XL
HEATHER ASH GRAY • 2869580
HEATHER OLIVE • 2869581



MEN'S ESTA TEE

» \$26⁹⁹ • S-3XL
CHARCOAL HEATHER • 2869552
NAVY • 2869562
BLACK • 2868570

**MEN'S FULL
ZIP HOODIE**

» \$74⁹⁹ • S-3XL
BLACK/RED • 2869530
NAVY • 2869532 NOT SHOWN

MEN'S RETRO CAP

» \$32⁹⁹ • ONE SIZE
CHARCOAL • 2869542





**MEN'S LONG SLEEVE
TECH 1/4 ZIP**

» \$67⁹⁹ • S-3XL
BLACK/RED • 2869535
GRAY/LIME • 2869536



**MEN'S TRAIL
MID LAYER**

» \$119⁹⁹ • S-3XL
GRAY/BLACK • 2869925

**MEN'S TECH
MESH BEANIE**

» \$26⁹⁹ • ONE SIZE
BLACK • 2868650



**MEN'S RETRO
TRUCKER CAP**

» \$32⁹⁹ • ONE SIZE
RED • 2869540

**MEN'S LONG SLEEVE
RETRO TEE**

» \$54⁹⁹ • S-3XL
GRAY • 2868571

**WOMEN'S BASEBALL
3/4 SLEEVE TEE**

» \$46⁹⁹ • S-3XL
WHITE/GRAY • 2869563

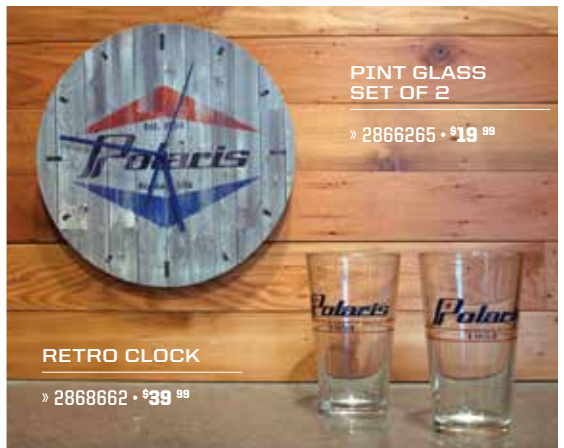

**PINT GLASS
SET OF 2**

» 2866265 • \$19⁹⁹

RETRO CLOCK

» 2868662 • \$39⁹⁹



**WOMEN'S
HEX TEE**

» \$32⁹⁹ • S-3XL
GRAY FROST • 2869566
NAVY FROST • 2869565

**WOMEN'S
RETRO CAP**

» \$32⁹⁹ • ONE SIZE
BLUE • 2869547

**WOMEN'S
SCRIPT CREW
SWEATSHIRT**

» \$67⁹⁹ • S-2XL
AQUA • 2869557

**WOMEN'S
RETRO
HOODIE**

» \$67⁹⁹ • S-3XL
NAVY • 2869555



MEN'S ROSEAU TEE

» \$32⁹⁹ • S-3XL
CHARCOAL HEATHER • 2869560
HEATHER BLUE • 2867778
ASH HEATHER • 2869561

BUILD WHAT THE PRO'S HAVE

These guys and gals know a thing or two about outfitting for what they do. They've done the leg work to build these up for you, all you have to do is visit the web address to view their machine, then you can customize it even further.



TYSON DURFEY WORLD CHAMPION TIE-DOWN ROPER



View this RANGER® & make it your own
[POLARIS.COM/RANGERrodeo](https://www.polaris.com/rangerrodeo)

RANGER XP® 1000 EPS
Pearl White

"As a Professional Rodeo Cowboy I depend on my Polaris RANGER® nearly every day of my life. I customize my RANGER® to efficiently handle my ranching tasks comfortably regardless of the weather. Not to mention it's a lot of fun on the trails on my days off."

- Tyler Durfey

UNLESS NOTED, TRADEMARKS ARE THE PROPERTY OF POLARIS® INDUSTRIES INC. 509® is a registered trademark of Polaris Industries Inc., Apple® is a registered trademark of Apple Inc., BatteryMinder® is a registered trademark of VDC Electronics Inc., Bluetooth® is a registered trademark of Bluetooth Sig. Inc., Browning® is a registered trademark of Browning Corporation, Calliper® is a trademark of Calliper, Inc., Camoplast® is a registered trademark of Camoplast Solideal Inc., Can-Am® and Defender® are trademarks of Bombardier Recreational Products Inc., Carhartt® is a registered trademark of Carhartt, Inc., CDOLLORE® is a registered trademark of Tempnology LLC, FOX® is a registered trademark of Fox Factory Inc., High Lifter is a trademark of High Lifter Products, Inc., Homelink® is a registered trademark of Johnson Controls Technology Inc., Honda® are registered trademarks of Honda Motor Company, Ltd., Mathews® is a registered trademark of MCP IP, MB Quart® is a registered trademark of Maxsonics USA Inc., Otter® is a registered trademark of Otter Outdoors, LLC, REALTREE Xtra® is a registered trademark of Jordan Outdoor Enterprises, Ltd., Rigid® is a registered trademark of Rigid Hitch, Inc., ScottSaver® is a registered trademark of Prince Lionheart, Inc., Tiger Drylac® is a registered trademark of Tiger Coatings GmbH & Co. KG, Yeti® is a registered trademark of Yeti Coolers, LLC, YKK® is a registered trademark of YKK Corporation. Prices and availability are subject to change at any moment. Copyright © 2018 Polaris Industries Inc. All rights reserved.

SCOTT SMITH

HIGH LIFTER PRODUCTS



"I test the limits of every High Lifter RANGER® that's made at the High Lifter Proving Grounds powered by Polaris®. Believe me, they pass the MUD Pit tests and in style with all the extras like Audio and Coolers so you can stay out all day."

- Scott Smith

View this RANGER® & make it your own
POLARIS.COM/RANGERmud

RANGER XP® 1000 EPS
RANGER CREW® XP 1000 EPS High Lifter Edition

THE LAKOSKY'S

CRUSH WITH LEE & TIFFANY

"We rely on Polaris RANGER® ...nothing's more powerful or more capable. We customize our RANGER® to help us find trophies in any terrain."

- Lee & Tiffany



View this RANGER® & make it your own
POLARIS.COM/RANGERcrush

RANGER XP® 1000 EPS
Polaris® Pursuit® Camo



BUILD YOUR ULTIMATE RANGER®

VISIT RANGER.POLARIS.COM TO SEE ALL YOUR OPTIONS & ACCESSORIES

Do the packages shown to the left not fill your specific need? No problem. Visit our website and build exactly what you want. See what a door looks like. Try on different wheels. **MAKE IT YOURS.**

1 CHOOSE MODEL

2 CHOOSE TRIM & COLOR

3 CHOOSE ACCESSORIES



ADD THE ACCESSORIES YOU WANT AND SEE YOUR NEW MACHINE FROM ANY ANGLE.

 POLARIS
RANGER®

BUILD YOUR **POLARIS RANGER**[®]

1 CHOOSE
MODEL

2 CHOOSE
TRIM & COLOR

3 CHOOSE
ACCESSORIES



VISIT POLARIS.COM/RANGER

TO SEE ALL YOUR OPTIONS & ACCESSORIES
ON YOUR NEW MACHINE FROM EVERY ANGLE!



CONNECT ONLINE
SEARCH "PolarisORV"



KEEP IT COLD.



SEE THE FULL LINE OF COOLERS
INCLUDING THE NEW 15 QT. MODEL
WITH AN EASY CARRY HANDLE

SEE P. 74



POLARIS[®]

MY19 RGR APP CAN • 9930484