

US VERSION



POLARIS®

SPORTSMAN®

2019

ACCESSORIES + APPAREL



LEGENDARY TOUGH

Sportsman® is legendary, giving you the ability to ride harder, go further and do more than any other ATV. From the farm yards to tearing up trails, the Polaris Sportsman line-up is chosen by more ATV owners than any other in the industry.

SPORTSMAN® MODELS & ACCESSORIES

COMMON ACCESSORIES

POLARIS ACE® MODELS & ACCESSORIES

PARTS & GARAGE

APPAREL & HELMETS

2019 LINEUP

RECREATION/UTILITY



SPORTSMAN® 450 H.O. (EPS)
33HP

SPORT/UTILITY



SPORTSMAN XP® 1000
90HP

2-UP & UTILITY



SPORTSMAN® TOURING 570 (EPS)
44HP

SPORT & MUD



SPORTSMAN XP® 1000 HIGH LIFTER EDITION
85HP



PRO ARMOR®
WHEELS & TIRES



POLARIS® PRO HD
WINCHES



RIGID® & PRO ARMOR®
LIGHTING



GLACIER® PLOW SYSTEMS



POLARIS ACE® 900 XC
78HP



POLARIS ACE® 570 EPS
45HP



POLARIS ACE® 500
32HP



POLARIS ACE® 150 EFI
15HP



2019 POLARIS® SPORTSMAN® ACCESSORIES

POLARIS ENGINEERED™ ACCESSORIES 02

SPORTSMAN®	
PROTECTION	06
XP 1000 • 850 SP • 850 STORAGE	08
570 SP • 570 • 450 STORAGE	10
XP TOURING STORAGE	12
BIG BOSS® / SCRAMBLER®	16

COMMON ACCESSORIES

HUNT	14
POLARIS NORTHSTAR® COOLERS	18
WINCHES	20
GLACIER® PLOW SYSTEMS	24
PRO ARMOR® WHEELS & TIRES	26
PROSPECTOR® PRO TRACKS / TECHNOLOGY	32
RIGID® & PRO ARMOR® LIGHTING	34
OFF-ROAD GRADE AUDIO SYSTEMS	36
ESSENTIALS	38

POLARIS ACE®

POLARIS ACE® 150	42
CAB SYSTEM	44
PROTECTION	46

PARTS & GARAGE

OIL & LUBRICANTS	48
MAINTENANCE	50
SERVICE PARTS	54
POLARIS POWER®	56
GARAGE & TRAILERING	58

APPAREL & HELMETS

RIDING GEAR	62
CASUALWEAR	64

KEEP YOUR STANDARDS HIGH

Ensuring Polaris Engineered Accessories™ fit and work in sync with your machine is the most critical phase of testing and validation. With seamless integration, you can trust that any Polaris® accessory you install will enhance your interaction beyond your expectations.

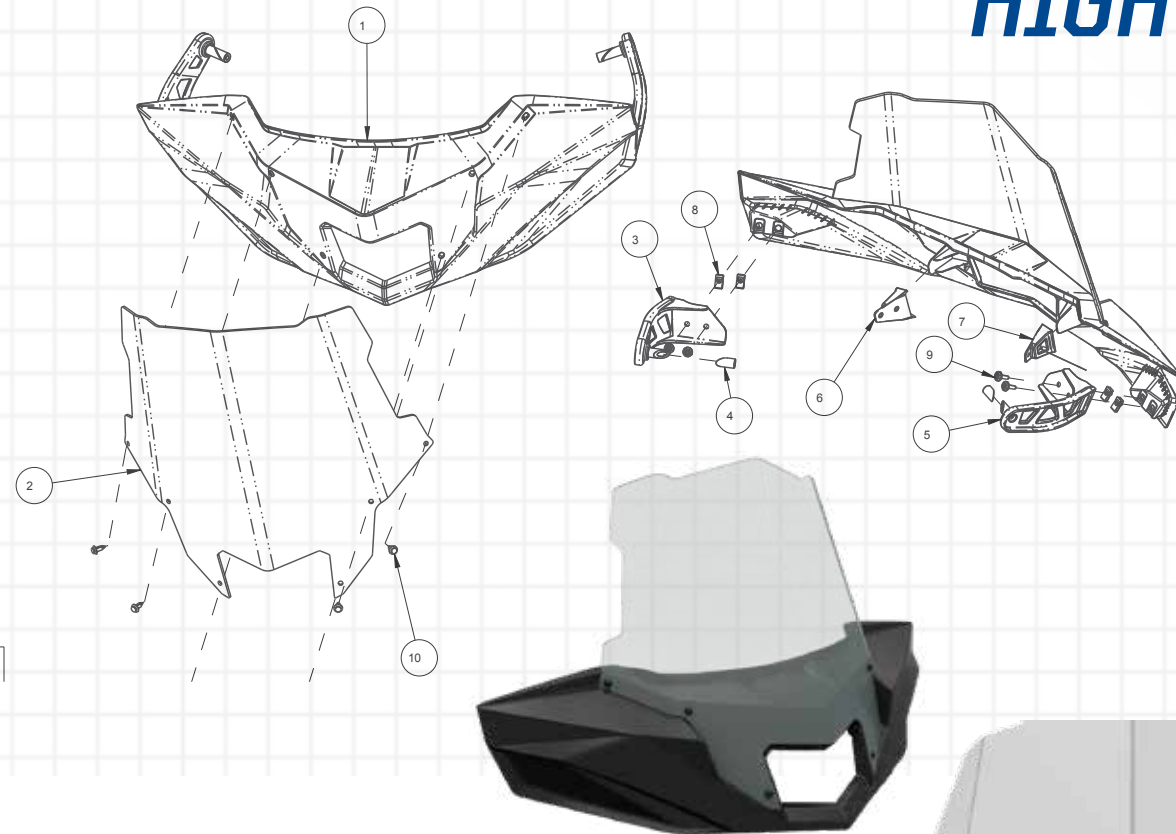

DESIGNED

Polaris offers the broadest lineup of accessories and most innovative solutions in off-road. Each one is meticulously crafted to match your machine.

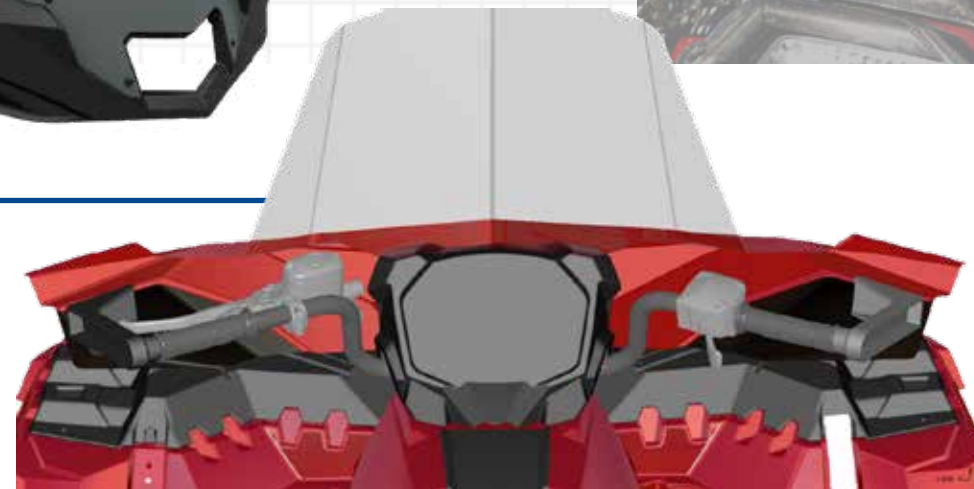

TESTED

By the time you get this gear, prototypes have gone through hell in our lab and been extensively tested in the field. You ride with 100% confidence.

TRUSTED

We've earned riders' trust over decades and we stand behind our work. Everything with our name on it comes with a one-year warranty.

BACKED BY A



WARRANTY

POLARIS® PARTNERS WITH THE BEST

We choose our partners carefully, selecting only the best in off-road. Every accessory is rigorously tested and validated at Polaris® standards, to ensure seamless integration and performance.

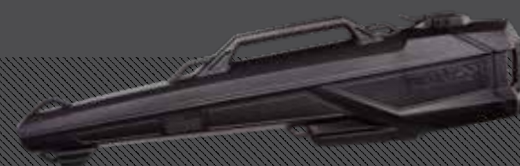

KOLPIN
OUTDOORS

HUNTING ACCESSORIES p.14



PRO ARMOR

WHEELS & TIRES p.26
LIGHTING SOLUTIONS p.34



RIGID

LIGHTING SOLUTIONS p.34



MBQUARTI

AUDIO COMPONENTS p.36

THE ULTIMATE ATV



POLARIS® SPORTSMAN XP® 1000
HAVASU RED PEARL

No matter where the trail takes you, you can rely on your legendary Sportsman XP® 1000, 850, & 850 SP and the new line of Polaris Engineered Ultimate Series Accessories™ to help you own your day off-road. Add everything from brushguards and lighting to windshields and storage racks to ensure you're equipped for the ultimate off-road ride.



A. WINDSHIELD FAIRING • 2882512

WINDSHIELD (MID) • 2882151

B. RACK EXTENDER 4"

(FRONT & REAR) • 2882022 & 2882023

C. FRONT BUMPER • 2882020

D. RIGID® 10" SR-SERIES COMBO LIGHT BAR • 2883123

LED LIGHT BAR HARNESS • 2882320

E. POLARIS® PRO HD 3500 LB WINCH • 2880435

F. BODY ARMOR • 2882090

G. POLARIS NORTHSTAR® COOLER - 30 QT • 2881315

H. POLARIS® RATCHET TIE-DOWN STRAPS BLACK • 2859047-02

I. PRO ARMOR® WHEEL & TIRE SET:

SIXR MATTE BLACK & ATTACK • 2881360

J. LOCK & RIDE® REAR CARGO BOX • 2882882

K. REAR BUMPER • 2882583

L. REAR CARGO HOLD BAG • 2882303

ALL-TERRAIN SAFEGUARDS



SPORTSMAN XP® 1000 / 850

A SPORTSMAN® ULTIMATE SERIES
-FRONT BUMPER

- Quick installation to the integrated mounting tubes on the vehicle using wedge-style expansion anchor mounts
- Attach the all-new Body Armor to the front bumper to provide the ultimate protection package for the front fenders

» 2882020 • \$259⁹⁹
XP 1000 '17-18, 850/850 SP '17-18

B SPORTSMAN® ULTIMATE SERIES
-BODY ARMOR

- Securely mounts to new Sportsman XP® Front Bumper (2882020)

» 2882090 • \$309⁹⁹
XP 1000 '17-18, 850/850 SP '17-18

C SPORTSMAN® ULTIMATE SERIES
-REAR BUMPER

» 2882583 • \$209⁹⁹
XP 1000 '17-18, 850/850 SP '17-18



EXPANSION WEDGE ANCHORS

Ultimate Series front and rear bumpers attach quickly and easily thanks to expansion wedge anchors. Since they fit into the integrated mounting points found on your Sportsman XP® 1000 or 850, there is no need to drill holes into the vehicle's frame.

SPORTSMAN® 570 / 450 H.O.
BRUSHGUARD TOP SELLER



- Durable black powdercoating for long-lasting, scratch-resistant finish

FRONT BRUSHGUARD

» 2879714 • \$229⁹⁹
X2 570 '15-19, TOURING 570 SP '15-19, TOURING 570 '14-19, ETX '15-16, 570 SP '15-19, 570 '14-19, 570 6X6 '17-19, 450 H.O. '16-19

REAR BRUSHGUARD

» 2879715 • \$179⁹⁹
TOURING 570 SP '15-19, TOURING 570 '14-19, ETX '15-16, 570 SP '15-19, 570 '14-19, 450 H.O. '16-19

SPORTSMAN XP®
BRUSHGUARD



- Integrated mounting location for easy installation and accessory lighting

FRONT BRUSHGUARD

» 2878709 • \$229⁹⁹
XP 1000 '15-16, X2 850 '11-12, X2 550 '10-14, TOURING XP 1000 '15-19, TOURING 850 SP '15-19, TOURING 850 '10-14, TOURING 550 '10-14, 850/XP 1000 '16-17, 850/850 SP '09-16, 550 '09-14

REAR BRUSHGUARD

» 2878710 • \$179⁹⁹
XP 1000 '15-16, 850/XP 1000 '16-19, 850/850 SP '09-16, 550 '09-14

SPORTSMAN®
DELUXE BRUSHGUARD

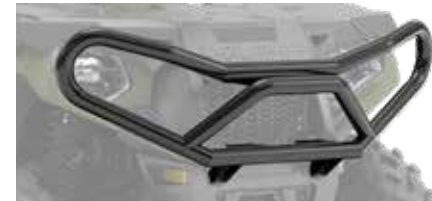

FRONT BRUSHGUARD

» 2878669 • \$209⁹⁹
TOURING 500 '13, 800 '12-14, 800 6X6 '12-14, 500 '12-14, 500 H.O. '12-13, 400 H.O. '12-14

REAR BRUSHGUARD

» 2878670 • \$144⁹⁹
800 '12-14, 500 '12-14, 500 H.O. '12-13, 400 H.O. '12-14



FARM & RANCH FRONT BUMPER

- Includes front receiver for additional functionality

» 2882301 • \$309⁹⁹
ETX '15, 570 '14-19, 450 H.O. '16-19
DOES NOT FIT 570 SP MODELS



SPORTSMAN®
TOURING
REAR BRUSHGUARD

- Adds heavy-duty rear protection and a custom look

» 2878324 • \$159⁹⁹
TOURING XP 1000 '15-19, TOURING 850 SP '15-19, TOURING 850 '10-14, TOURING 550 '10-14



SPORTSMAN® X2®
REAR BUMPER

- Distinctive off-road styling for customization

- Provides additional protection from trail hazards

- Designed specifically for the Sportsman X2®

» 2877686 • \$124⁹⁹
X2 850 '11-12, X2 550 '10-14, 570 X2 '17-19

SPORTSMAN® ULTIMATE SERIES XP 1000 – 850 SP – 850

The ultimate rec / utility ATVs deserve the ultimate line of accessories. Equip your Sportsman XP® 1000 or 850 with our line of Ultimate Accessories and enjoy all-day comfort. Add a windshield to cut the bitterly cold wind, keep your hands warm with a simple-to-install hand warmer kit, prevent items from sliding off your racks with an extension kit, or simply add more storage.

SPORTSMAN® ULTIMATE SERIES WINDSHIELDS

WINDSHIELD FAIRING

- Customizable system based on your style and protection needs
- All-new fairing is the base for the best wind protection system to date

» 2882512 • \$159⁹⁹
XP 1000 '17-18, 850/850 SP '17-18



WINDSHIELD FAIRING BAG

» 2882454 • \$39⁹⁹
XP 1000 '17-18, 850/850 SP '17-18



EASY TO CHANGE WINDSHIELDS
WITH 6-DART INSTALL

Our fairing system allows for changing out the windshield quickly and easily. Simply remove the six dart-type fasteners and swap out the windshield.

TALL VIEW

» 2882152 • \$104⁹⁹
XP 1000 '17-18, 850/850 SP '17-18

TALL VIEW HARD COAT

» 2881161 • \$209⁹⁹
XP 1000 '17-18, 850/850 SP '17-18

MID VIEW

» 2882151 • \$94⁹⁹
XP 1000 '17-18, 850/850 SP '17-18

LOW VIEW

» 2882150 • \$84⁹⁹
XP 1000 '17-18, 850/850 SP '17-18

HARD COAT

Give your impact-resistant poly windshield extra defense. Hard coat is 30x more scratch-resistant, meaning you'll be able to handle whatever gets thrown at you.

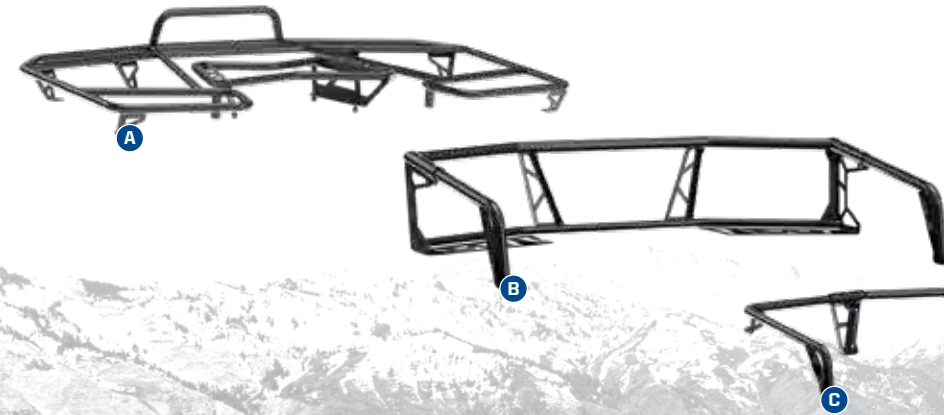
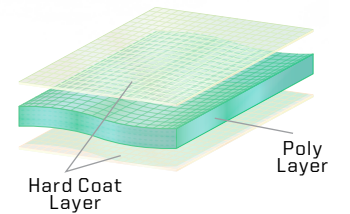

A	B	C	D
SPORTSMAN® STEEL RACK	ULTIMATE SERIES RACK EXTENDER 7"	ULTIMATE SERIES RACK EXTENDER 4"	MOVEABLE TIE-DOWN POINTS
REAR	REAR	REAR	FRONT / REAR
» 2883258 • \$209 ⁹⁹ XP 1000 '17-18, 850/850 SP '17-18	» 2882025 • \$159 ⁹⁹ XP 1000 '17-18, 850/850 SP '17-18 Does not fit with (2882882)	» 2882023 • \$104 ⁹⁹ XP 1000 '17-18, 850/850 SP '17-18 Fits with Rear Cargo Box (2882882)	» 2882270 • \$54 ⁹⁹ (SOLD IN PAIRS) XP 1000 '17-18, 850/850 SP '17-18



E	F	G
ULTIMATE SERIES RACK EXTENDER 4"	ULTIMATE SERIES RACK EXTENDER 7"	SPORTSMAN® STEEL RACK
FRONT	FRONT	FRONT
» 2882022 • \$104 ⁹⁹ XP 1000 '17-18, 850/850 SP '17-18	» 2882024 • \$159 ⁹⁹ XP 1000 '17-18, 850/850 SP '17-18	» 2883257 • \$159 ⁹⁹ XP 1000 '17, 850/850 SP '17-18



LOCK & RIDE SPORTSMAN® ULTIMATE SERIES REAR CARGO BOX

- Increase your ATV storage with an extra 25 gallons of capacity
 - Store two full-size helmets.
- » 2882882 • \$309⁹⁹
XP 1000 '17-18, 850/850 SP '17-18



SPORTSMAN® ULTIMATE SERIES REAR CARGO HOLD BAG

- Upgrade your stock rear storage component with this removable, divided storage bag
- » 2882303 • \$59⁹⁹
XP 1000 '17-18, 850/850 SP '17-18

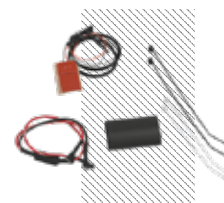

THROTTLE/THUMB WARMERS

- Low profile black switch
- » 2877364 • \$46⁹⁹
ALL SPORTSMAN® MODELS



HANDLEBAR HAND WARMERS

- Low profile black switch
- » 2877363 • \$59⁹⁹
ALL SPORTSMAN® MODELS



ULTIMATE SERIES - READYPACK

- Keep your trail essentials at the ready with this easy-to-access, weather-resistant storage compartment
- » 2882271 • \$64⁹⁹
XP 1000 '17-18, 850/850 SP '17-18



LOCK & RIDE FRONT CARGO BOX

- Replaces stock rack, adds convenient storage location
- » 2877951 • \$179⁹⁹
XP 1000 '15-16, TOURING XP 1000 '15-19, TOURING 850 SP '15-19, TOURING 850 '10-14, TOURING 550 '10-14, 850/850 SP '09-16, 550 '09-14

SPORTSMAN® 570 SP – 570 – 450 SERIES

Hardworking and smooth riding combine to give you the legendary Polaris Sportsman® ATV. On your land, on the farm, or at the job site, Sportsman® has accessories to make your day more comfortable and convenient.

SPORTSMAN® LOCK & RIDE® POLY WINDSHIELDS



Mid 15.5" (39.4 cm) Black Low 9.5" (24.1 cm) Black

LOCK & RIDE SPORTSMAN® WINDSHIELDS

SIZE	COLOR	PART #	PRICE	SIZE	COLOR	PART #	PRICE
TALL 19.25" (48.9 CM)	CLEAR	2878389	• \$134 ⁹⁹	TALL 19.25" (48.9 CM)	CLEAR	2880539-409	• \$159 ⁹⁹
MID 15.5" (39.4 CM)	BLACK	2878388-070	• \$159 ⁹⁹	MID 15.5" (39.4 CM)	BLACK	2880540-070	• \$169 ⁹⁹
MID 15.5" (39.4 CM)	SMOKE	2878388	• \$134 ⁹⁹	MID 15.5" (39.4 CM)	SMOKE	2880540-412	• \$144 ⁹⁹
LOW 9.5" (24.1 CM)	BLACK	2878387	• \$89 ⁹⁹	LOW 9.5" (24.1 CM)	BLACK	2880541-070	• \$124 ⁹⁹

X2 570 '15-19, TOURING 570 '14-19, TOURING 500 '13, ETX '15, 800 6X6 '12-14, 800 '12-14, 570 '14-17, 500 H.O. '12-13, 500 '12-14, 450 H.O. '16-17, 400 H.O. '12-14

XP 1000 '15-16, TOURING XP 1000 '15-19, TOURING 850 SP '15-19, TOURING 570 SP '15-19, 850/850 SP '09-16, 570 SP '15-19, 570 '18-19, 570 6X6 '17-19, 450 H.O. '18-19, X2 570 '18-19



HANDGUARDS

COLORS

BLACK	2876846	• \$30 ⁹⁹
BRIGHT WHITE	2876883	• \$30 ⁹⁹
INDY RED	2876845	• \$30 ⁹⁹

ALL SPORTSMAN® MODELS

HANDGUARD MOUNT

• This handguard mount is required when installing Polaris® Handguards

» 2879380 • \$30⁹⁹
ALL SPORTSMAN®



SPORTSMAN® 570/450 H.O. RACK EXTENDERS TOP SELLER

FRONT

» 2879716 • \$104⁹⁹
X2 570 '15-19, TOURING 570 SP '15-19, TOURING 570 '14-19, ETX '15, 570 SP '15-19, 570 '14-19, 570 6X6 '17-19, 450 H.O. '16-19

SPORTSMAN® 570/450 H.O. STEEL RACK

FRONT

» 2882321 • \$134⁹⁹
X2 570 '15-19, TOURING 570 '14-19, 570 SP '15-19, 570 '14-19, 570 6X6 '17-19, ETX '15, 450 H.O. '16-19



SPORTSMAN® 570/450 H.O. STEEL RACK

REAR

» 2882322 • \$209⁹⁹
ETX '15, 570 SP '15-19, 570 '14-19, 450 H.O. '16-19

SPORTSMAN® 570/450 H.O. RACK EXTENDERS TOP SELLER

REAR

» 2879717 • \$104⁹⁹
ETX '15, 570 SP '15-19, 570 '14-19, 450 H.O. '16-19

LOCK & RIDE SPORTSMAN® BACKREST

REAR

» 2879887 • \$209⁹⁹
ETX '15, 570 SP '15-19, 570 '14-19, 450 H.O. '16-19



BUILD YOUR OWN SPORTSMAN.
POLARIS.COM/SPORTSMAN



LOCK & RIDE SPORTSMAN® ULTIMATE SERIES REAR CARGO BOX

- Increase your ATV storage with an extra 25 gallons of capacity
- Store two full-size helmets.

» 2882882 • \$309⁹⁹
ETX '15, 570 SP '15-19, 570 '14-19, 450 H.O. '16-19



FENDER BAG

- Easy to access while seated
- Pockets hold water bottles

» 2876604 • \$54⁹⁹
ALL SPORTSMAN® MODELS
Bag does not work with the Front Storage Box (2877951)



HANDLEBAR HAND WARMERS

- Low profile black switch

» 2877363 • \$59⁹⁹
ALL SPORTSMAN® MODELS

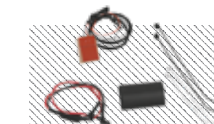

THROTTLE/THUMB WARMERS

- Low profile black switch

» 2877364 • \$46⁹⁹
ALL SPORTSMAN® MODELS

SPORTSMAN XP® TOURING

When you are enjoying the trails on your Sportsman® Touring XP 1000, you need a line of accessories that won't get in the way of your passenger's experience. All Sportsman XP® Touring accessories are designed specifically to enhance the 2-up experience.

SPORTSMAN® LOCK & RIDE® POLY WINDSHIELDS



Mid 15.5" (39.4 cm) Black



Low 9.5" (24.1 cm) Black

Poly windshields are flexible, **IMPACT RESISTANT**, and provide long-term value over the life of your machine.

LOCK & RIDE SPORTSMAN® WINDSHIELDS

COLOR	SIZE	SKU	PRICE
CLEAR	TALL 19.25" (48.9 CM)	2880539-409	» \$159 ⁹⁹
BLACK	MID 15.5" (39.4 CM)	2880540-070	» \$169 ⁹⁹
SMOKE	MID 15.5" (39.4 CM)	2880540-412	» \$144 ⁹⁹
BLACK	LOW 9.5" (24.1 CM)	2880541-070	» \$124 ⁹⁹

XP 1000 '15-16, TOURING XP 1000 '15-19, TOURING 850 SP '15-19, TOURING 570 SP '15-19, 850/850 SP '09-16, 570 SP '15-19, 570 '18-19, 570 6X6 '17-19, 450 H.O. '18-19



A XP RACK EXTENDER

FRONT

» 2879890 • \$104⁹⁹
 XP 1000 '15-16, X2 850 '11-12, X2 550 '10-14, TOURING XP 1000 '15-19, TOURING 850 SP '15-19, TOURING 850 '10-14, TOURING 550 '10-14, 850/850 SP '09-16, 550 '09-14

B SPORTSMAN® RACK EXTENDER

FRONT

» 2878671 • \$94⁹⁹
 TOURING 500 '13, 800 6X6 '12-14, 800 '12-14, 500 H.O. '12-13, 500 '12-14, 400 H.O. '12-14



SEMI-RIGID TOURING CARGO BAG

- Large-capacity, heavy-duty vinyl bag
- Three zippered openings, removable dividers
- Attaches to rack with Velcro® straps

» 2877220 • \$159⁹⁹
 TOURING 570 '14-19, TOURING 500 '13, 500 H.O. '12



LOCK & RIDE REAR STORAGE BOXES

- Made of heavy-duty polyethylene (Sold in pairs)

» 2878000 • \$199⁹⁹
 TOURING XP 1000 '15-19, TOURING 850 SP '15-19, TOURING 850 '10-14, TOURING 550 '10-14
 Slight interference with Sportsman® Touring 550/850 '11-14 passenger handles



LOCK & RIDE FRONT CARGO BOX

- Replaces stock rack, adds convenient storage location

» 2877951 • \$179⁹⁹
 XP 1000 '15-16, TOURING XP 1000 '15-19, TOURING 850 SP '15-19, TOURING 850 '10-14, TOURING 550 '10-14, 850/850 SP '09-16, 550 '09-14

The Front Rack Extender cannot be installed at the same time as the storage box.



FENDER BAG

- Perfect place to store gear and snacks
- Easy to access while seated

» 2876604 • \$54⁹⁹
 ALL SPORTSMAN® MODELS
 Bag does not work with the Front Storage Box (2877951)

BUILD YOUR OWN SPORTSMAN.[®]
POLARIS.COM/SPORTSMAN



**PROTECT THE GEAR YOU NEED.
LIVE THE LIFE YOU LOVE.**



KOLPIN STRONGHOLD® SYSTEM

Polaris® is proud to partner with Kolpin® Outdoors, an industry leader in off-road accessories and the premier name in gun boots and mounts. If you need to secure a firearm, ice fishing rods, an ice auger or a pop-up blind while riding, simply attach the auto-latch mount and choose your case.

IDEAL FOR SCOPED RIFLES, SHOTGUNS AND LONG-BARRELED PISTOLS

STEP 1 CHOOSE YOUR MOUNT



2882300

2882272

STEP 2 CHOOSE YOUR BOOTS



Includes Transport Case

KOLPIN STRONGHOLD® PRODUCTS SECURELY PROTECT THE ESSENTIALS WHEN ON THE TRAIL.



AUTO-LATCH MOUNT

- Precision angle adjustable for a custom fit
- Provides a quick and secure attachment point

» 2882300 • \$69⁹⁹ » 2882272 • \$69⁹⁹
ETX '15, 570 SP '15-19, 570 '14-19, 450 H.O. '16-19 XP 1000 '17-18, 850/850 SP '17-18

GUN BOOT® XL – TRANSPORT

- 52" L x 3 3/4" W x 10 1/2" H

» 2882430 • \$99⁹⁹
Requires Auto-Latch Mount (2882272 or 2882300)

GUN BOOT® L – IMPACT

- 52" x 4 1/4" x 9 1/4" H

» 2882426 • \$59⁹⁹
Requires Auto-Latch Mount (2882272 or 2882300)

PISTOL BOOT

- 15 1/2" L X 2 1/2" W x 8 3/4" H

» 2882429 • \$49⁹⁹
Requires Auto-Latch Mount (2882272 or 2882300)

ICE AUGER / POP-UP BLIND BOOT

- 46" L X 12 1/2" W

» 2882427 • \$79⁹⁹
Requires Auto-Latch Mount (2882272 or 2882300)

ICE ROD BOOT

- 39" x 18 1/2" x 6" H

» 2882428 • \$99⁹⁹
Requires Auto-Latch Mount (2882272 or 2882300)

KOLPIN RHINO GRIPS®



IDEAL FOR BOWS, CROSSBOWS AND UNCASSED LONG GUNS



LOCK & RIDE

RHINO GRIP® PRO BY KOLPIN® *NEW*

» 2884119 • \$79⁹⁹
ALL SPORTSMAN® MODELS (EXCEPT UTILITY EDITIONS & YOUTH)
ALL ACE® MODELS (EXCEPT 150)



LOCK & RIDE

RATCHETING RHINO GRIP® BY KOLPIN®

» 2881157 • \$59⁹⁹
ALL SPORTSMAN® MODELS (EXCEPT UTILITY EDITIONS & YOUTH)
ALL ACE® MODELS (EXCEPT 150)



LOCK & RIDE

RHINO GRIP® XL DOUBLE BY KOLPIN® *NEW*

» 2884120 • \$64⁹⁹
ALL SPORTSMAN® MODELS (EXCEPT UTILITY EDITIONS & YOUTH)
ALL ACE® MODELS (EXCEPT 150)



LOCK & RIDE

RHINO GRIP® XL BY KOLPIN®

» 2881513 • \$39⁹⁹
ALL SPORTSMAN® MODELS (EXCEPT UTILITY EDITIONS & YOUTH)
ALL ACE® MODELS (EXCEPT 150)

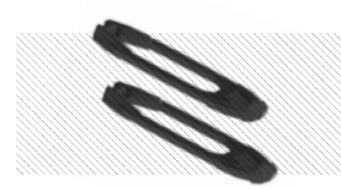

RHINO GRIP® PRO RUBBER STRAPS BY KOLPIN® *NEW*

» 2884109 • \$7⁹⁹
RHINO GRIP® PRO



RHINO GRIP® XL RUBBER STRAPS BY KOLPIN®

» 2881621 • \$4⁹⁹
RHINO GRIP® XL

THANKS TO OUR PARTNERS. We would like to thank our partners Browning® and Mathews® for helping to deliver a successful and safe off-road experience when out in the field.



SPORTSMAN® BIG BOSS® 6X6 ACCESSORIES

LOCK & RIDE® YUKON ADVENTURE RACK

- Adds increased storage volume by allowing you to increase storage height securely

» 2882084 • \$309⁹⁹
570 6X6 '17-19

LOCK & RIDE® CARGO BOX ADAPTOR KIT

- Required to add the Sportsman® Cargo Box (2875176) onto the '17-18 Sportsman® Big Boss® 6x6

» 2882302 • \$104⁹⁹
570 6X6 '17-19
Requires (2875176)



PROSPECTOR PRO® TRACK SYSTEM

- Delivers true 3-season performance with more flotation and less maintenance

- Rubber pivot system allows rear axles to move independently for maximum traction

- Includes Track Mount & Track Kit

» 2882169 • \$5,999⁹⁹
570 6X6 '17-19

SPORTSMAN® BIG BOSS® 6X6



ADDITIONAL ACCESSORIES

WINCHES p 22

PLOW p 24

FRONT BRUSHGUARD p 08

FRONT RACK EXTENDER p 10

LIGHTING p 34

WHEELS & TIRES p 26

POLARIS® SCRAMBLER®

Power, performance, and handling distinguish this unique ATV from the competition. Make sure to make it your own with accessories designed specifically for this hardworking sport performer.



A OGIO® SCRAMBLER® BAG

» 2879925 • \$179⁹⁹
SCRAMBLER® '13-18

B LARGE REAR RACK

» 2879139 • \$169⁹⁹
SCRAMBLER® '13-18
Not compatible with Ogio® Scrambler® Bag (2879925)

C REAR BASH GUARD

» 2879138 • \$144⁹⁹
SCRAMBLER® '13-18

D HANDGUARDS

» 2876846 • BLACK • \$30⁹⁹
SCRAMBLER® '13-18

HANDGUARD MOUNTS

» 2879380 • BLACK • \$30⁹⁹
ALL SPORTSMAN®

E POLARIS® HD 2500 LB WINCH

» 2880433 • \$399⁹⁹
SCRAMBLER® '13-18

POLARIS® HD 3500 LB WINCH

» 2880435 (NOT SHOWN) • \$469⁹⁹

WINCH WIRING HARNESS

» 2879919 • \$25⁹⁹
SCRAMBLER® XP 1000 '14-17,
SCRAMBLER® 850 '13-17,
Required to install Polaris® HD Winches

F HANDLEBAR HEADLIGHT

» 2879245 • \$349⁹⁹
SCRAMBLER® '13-18

G BRUSHGUARD

» 2879136 • \$209⁹⁹
SCRAMBLER® '13-18

H PRO ARMOR® WHEEL & TIRE SET: REBLR & ATTACK

» 2881381 • \$1,289⁹⁹

10MM X 1.25 HEX LUG NUTS (16 PACK)

» 2877384 • \$30⁹⁹

I FORGED BEADLOCK RINGS

» 14" VOODOO BLUE • 1522244-619
\$84⁹⁹

Sold individually. See other forged beadlock rings on pg 30.

LOCK & RIDE® GUN BOOT® MOUNTS

- High-impact case secures firearm over any terrain

- Lock & Ride® system mounts on right side

- Works with Lock & Ride® XL Storage Box, Lock & Ride® Rear Cargo Box, and Rear Rack Extenders

» 2879888 • \$124⁹⁹
570 6X6 '17-19

LOCK & RIDE® GUN BOOT® MOUNT ADAPTOR KIT

- Utilize this adapter kit to add the Lock & Ride® Gun Boot® Mount (2879888) onto the '17-19 Sportsman® Big Boss® 6x6

» 2882257 • \$36⁹⁹
570 6X6 '17-19

POLARIS® GUN BOOTS BY KOLPIN®

» BLACK • 2872677 • \$59⁹⁹

» MOSSY OAK® BREAK-UP® • 2872677-419 • \$89⁹⁹

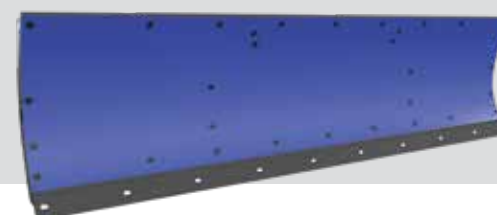

GLACIER^{PRO}
PLOW SYSTEM
Page 24 for Plow Systems



PROSPECTOR PRO® TRACKS
Page 32



PRO ARMOR® WHEELS & TIRES
Page 26

KEEP IT ICE COLD

POLARIS NORTHSTAR® COOLERS can survive just about anything - from extreme heat to a nasty tumble off a vehicle. So when we say ice will stay cold for hours on end and anything inside will stay locked up tight, we mean it.

POLARIS NORTHSTAR® COOLER



- | | | | | |
|--|---|---|--|--|
| 105 QUART
» GRAPHITE • 2883426 • \$399⁹⁹
» DESERT • 2883392 • \$399⁹⁹ | 60 QUART
» GRAPHITE • 2883425 • \$309⁹⁹
» DESERT • 2881259 • \$309⁹⁹ | 30 QUART
» GRAPHITE • 2883424 • \$239⁹⁹
» DESERT • 2881315 • \$239⁹⁹ | 15 QUART NEW
» GRAPHITE • 2883968 • \$189⁹⁹ | 20 QUART SOFTSIDE
» GRAPHITE • 2883390 • \$159⁹⁹ |
|--|---|---|--|--|

30, 60 & 105 QUART FEATURES

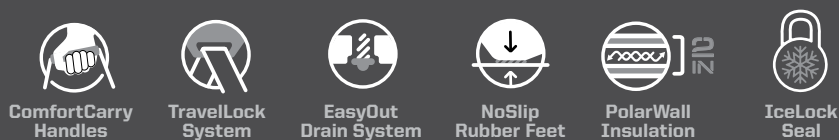

TUMBLERS

- » 30 OZ • 2883394 • **\$25⁹⁹**
- » 20 OZ • 2883393 • **\$20⁹⁹**

GRIZZLY TESTED. POLARIS® APPROVED.



This cooler is IGBC-approved, meaning it withstands the power expended by a typical grizzly bear if it was trying to get inside. Seriously, there are experts who know what a grizzly is capable of doing, and they certify that the Polaris Northstar® Cooler can take it.



POLARIS NORTHSTAR® COOLERS

POLARIS NORTHSTAR® COOLER ACCESSORIES



WIRE BASKET

- » 105 QUART • 2883648 • **\$41⁹⁹** **NEW**
- » 60 QUART • 2882185 • **\$30⁹⁹**
- » 30 QUART • 2882438 • **\$25⁹⁹**



DIVIDERS

- » 105 QUART • 2883468 • **\$30⁹⁹** **NEW**
COMES WITH ONE DIVIDER
 - » 60 QUART • 2882184 • **\$41⁹⁹**
COMES WITH TWO DIVIDERS
 - » 30 QUART • 2882186 • **\$20⁹⁹**
COMES WITH ONE DIVIDER
- Divider doubles as a cutting board



105 QUART
1 way to partition



60 QUART
2 ways to partition



30 QUART
1 way to partition



SEAT CUSHION

- » 60 QUART • 2882179 • **\$84⁹⁹**
- » 30 QUART • 2882507 • **\$64⁹⁹**

COOLER WHEELS

- » 60 QUART • 2882180 • **\$94⁹⁹**

BOTTLE OPENER

- » 2882183 • **\$10⁹⁹**
ALL COOLERS



HOLDS ICE 30+ HOURS LONGER THAN YETI®*

*YETI is a registered trademark of YETI COOLERS, LLC



NEW 1.5" X 16' 5,500 LB RATCHET STRAP

- Heavy duty webbing
- 5,500 Lb. Maximum Load / 1,833 Lb. Working Load
- 2 Pack

» 2884031 • **\$41⁹⁹**



NEW 2" X 20' 10,000 LB RATCHET STRAP

- Heavy duty webbing
- 10,000 Lb. Maximum Load / 3,300 Lb. Working Load
- Floating D-Rings
- Double J-Hooks

» 2884032 • **\$30⁹⁹**

SUPERIOR

INTEGRATION

POLARIS
ENGINEERED

WINCHES / PLOWS INTEGRATION

Right from the factory, your vehicle is built to make essential accessories like winches and plows quick and simple to install and use regularly. Mounting brackets are designed into the chassis and wiring is routed securely and properly. Perfect fit, perfect integration.

GLACIER^{PRO} HD
PLOW SYSTEM

**DEPENDABLE. TOUGH.
BUILT FOR THE OFF-ROAD.**



✓ **Tested 1,200+ pulls at max load, it works when you need it to**



✓ **Built to withstand -20° F temperatures**



✓ **Sealed motor & heavy duty gears OPERATE FULLY SUBMERGED UNDERWATER**



✓ **MILITARY tested & approved**

PRE-WIRED CHASSIS

Handlebar controls and wiring are installed at the factory. Mount the winch, connect the wires and trust that everything is routed safely, securely, and properly.

NO NEED TO CUT PANELS

FULLY INTEGRATED MOUNT & WIRING

WINCHES

PLOWS

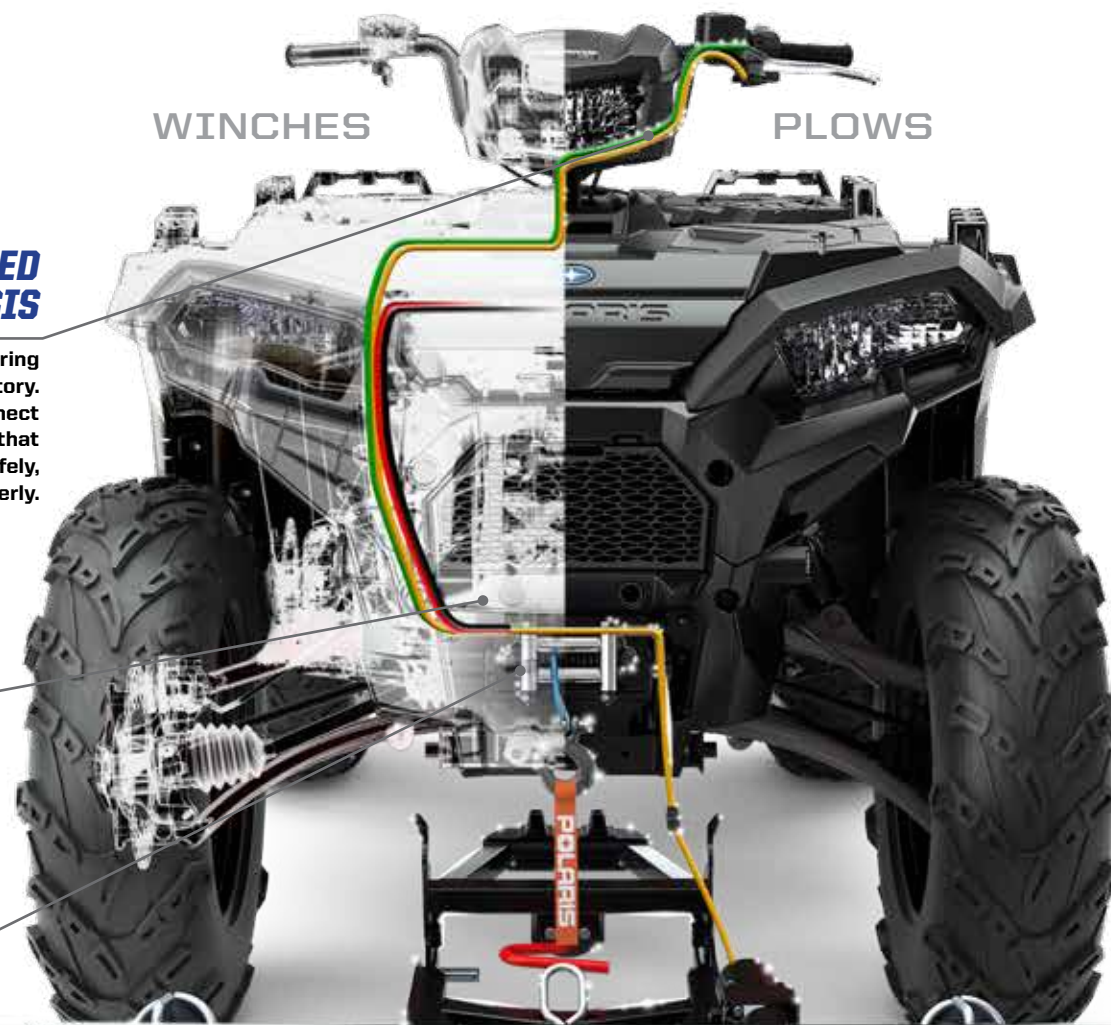

GLACIER[®] vs. COMPETITION



WARN[®]



MOOSE UTILITY DIVISION[®]



SUPERATV

- ✓ To install the plow, simply lift the mount lock handle and pull forward.
- ✓ No loss of factory ground clearance when not plowing.
- ✓ Don't have to crawl under the machine to release the plow blade from the vehicle.
- ✓ No trimming of vehicle plastic or fascia required to mount plow or winch.

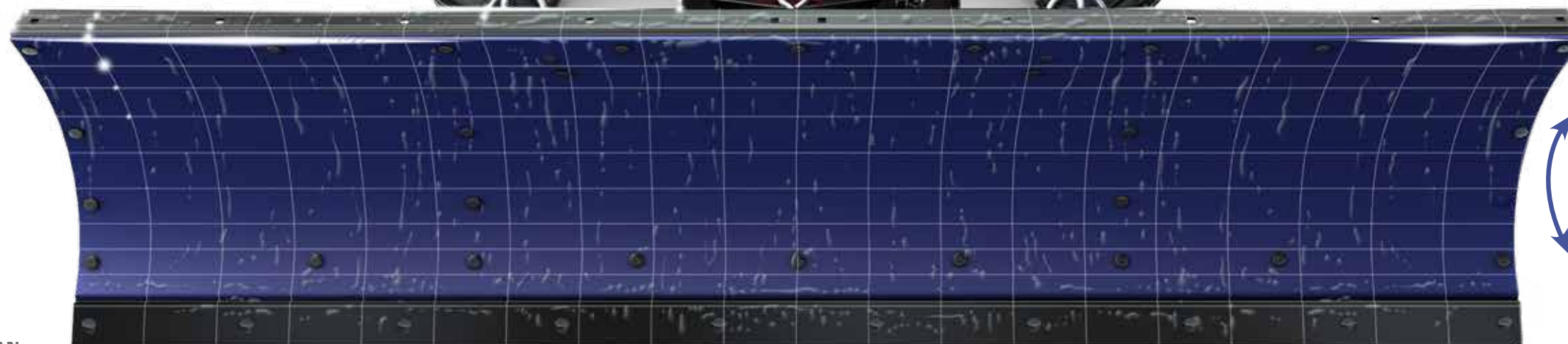

25°

LEFT AND RIGHT



ANGLE YOUR BLADE RIGHT FROM YOUR SEAT

PRO PRO HEAVY DUTY SERIES

PREMIUM FEATURES FOR TOP-OF-THE-LINE POWER



INDUSTRY **NEW** **TECHNOLOGY**

RAPID ROPE RECOVERY 5x FASTER

- RAPID ROPE RECOVERY**
1. Set Winch Dial to FREE SPOOL (N) to attach Winch Hook
 2. Set Winch Dial to PULL (L) for Winch Mode
 3. Set Winch Dial to ROPE RECOVERY (H) for 5x Faster Rope Recovery

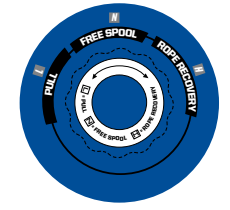

PREASSEMBLED

Winch ready to install out of the box. Attached to mount and pre-wired.

WIRELESS REMOTE

50 Ft. range wireless remote control with unique code for interference-free operation

PREMIUM SYNTHETIC ROPE

- Lightweight & Easy to Handle
- Superior Flexibility
- Greater Strength than Steel Cable
- 50ft Long

AUTO STOP TECHNOLOGY

Auto Stop Technology stops winch at end of pull to prevent driveline stress and plow overlifting

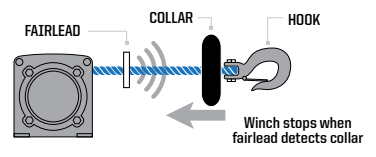

HD HEAVY DUTY SERIES

PULLING POWER FOR EVERYDAY USE & PERFORMANCE



- Cut steel gears for improved durability
- Steel spool can handle extreme loads
- 40% quieter – near-silent free spooling
- Sealed motor and drivetrain
- High-powered contactor
- Integrated wiring and mount plates ensure perfect fit

UPGRADE YOUR POLARIS® HD WINCH WITH THESE ACCESSORIES

POLARIS® WIRELESS WINCH REMOTE

» 2879316 • \$134⁹⁹

ALL SPORTSMAN® & POLARIS ACE® MODELS

POWER CONTROLLER

- Allows the rider to control plow angle and blade height from inside the cab

» 2880836 • \$104⁹⁹

POLARIS ACE® 900 XC '18-19, POLARIS ACE® 570 SP '16-17, POLARIS ACE® 570 '15-19, POLARIS ACE® 500 '17-19, POLARIS ACE® '14-16

POLARIS® AUTO-STOP TECHNOLOGY WINCH UPGRADE KIT

- Requires use of synthetic cable rope (not included)

» 2881693 • \$104⁹⁹

ALL SPORTSMAN® & POLARIS ACE® MODELS

SYNTHETIC WINCH ROPE

- Includes pre-woven hook

» 2878888 • \$79⁹⁹

2500 LB & 3500 LB WINCHES

WHY UPGRADE TO SYNTHETIC?

- Easier to work with - flexible and smooth texture
- More durable for plow usage
- Doesn't kink or bind like steel cable
- Lighter weight - even floats on water

3 STEPS FOR ADDING A WINCH:

1 FIND YOUR MACHINE

2 CHOOSE BETWEEN POLARIS® PRO HD

OR POLARIS® HD WINCH

3 ADD CABLES

MODEL	PRO PRO HEAVY DUTY SERIES		HD HEAVY DUTY SERIES		REQUIRED BATTERY CONNECTION CABLES
	4,500 LB. WINCH SERIES	3,500 LB. WINCH SERIES	3,500 LB. WINCH SERIES	2,500 LB. WINCH SERIES	
POLARIS® SPORTSMAN® 450 H.O. '16-19 570 '14-19 570 SP '15-19 570 X2 '15-19 TOURING 570 '14-19 570 X2 SP '16-19 570 6X6 '17-19		2882242 \$549 ⁹⁹	TOP SELLER 2880434 \$469 ⁹⁹ with Synthetic Rope	TOP SELLER 2880432 \$399 ⁹⁹	
POLARIS ACE® 570 SP '15-17 900 SP '16 500 '17-19 570 '16-19 900 XC '17-19		2882243 \$549 ⁹⁹	TOP SELLER 2880435 \$469 ⁹⁹ with Synthetic Rope	TOP SELLER 2880433 \$399 ⁹⁹	Only Scrambler Models MY14-15: 2879919 \$25 ⁹⁹
POLARIS® SPORTSMAN® XP 1000 / 850 SP / 850 '15-18 XP 1000 / 850 HIGHLIFTER EDITION '16-19 SCRAMBLER XP 1000/850 '14-18 TOURING XP 1000/850 '15-19		2882241 \$549 ⁹⁹	TOP SELLER 2880435 \$469 ⁹⁹ with Synthetic Rope	TOP SELLER 2880433 \$399 ⁹⁹	Only Scrambler Models MY14-15: 2879919 \$25 ⁹⁹

GLACIER®

PLOW SYSTEM

When you have the power of a Glacier® Pro Plow System on your machine, you can truly take command of clearing snow and moving whatever you need to. Find the blade that fits your needs and you'll make quick work of even the heaviest jobs.



THE POLARIS ENGINEERED™ ADVANTAGE

INSTALLATION

30 seconds: Drive up, clip in, lock down, and go – the integrated Polaris Engineered™ Glacier® Plow System simplifies plowing.

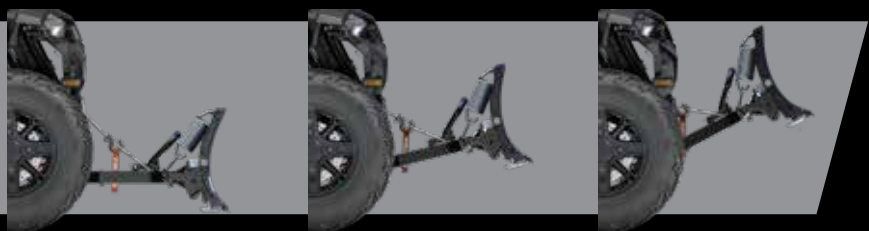

CONVENIENCE

Lift and angle adjustments can be made from the driver's seat.

ANGLE YOUR BLADE RIGHT FROM YOUR SEAT WITH THE GLACIER® PRO PLOW HYDRAULIC ANGLE SYSTEM



ROBUST FRAME

A plow system is only as strong as its frame, and Polaris Engineered™ plow frames have a wide frame to withstand the rigors of heavy plowing.



DURABILITY

Available in strong stamped steel or corrosion-resistant poly materials, Polaris Engineered™ plow blades cover a large surface area for quick snow removal.

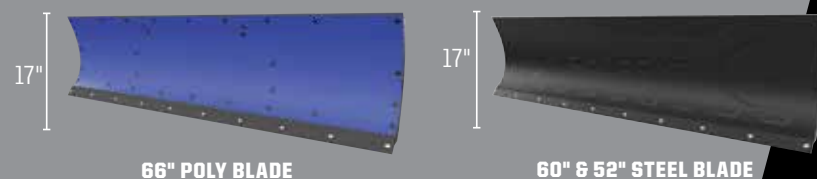

66" POLY BLADE

60" & 52" STEEL BLADE

BUILD YOUR PERFECT PLOW SYSTEM

GLACIER
PLOW SYSTEM



ANGLE YOUR BLADE RIGHT FROM YOUR SEAT WITH THE GLACIER® PRO PLOW HYDRAULIC ANGLE SYSTEM

1 SELECT A MOUNT

GLACIER® INTEGRATED PLOW MOUNT

• Fits all current Glacier® Pro Plow System components

- » 2881423 • \$179⁹⁹
XP 1000 '15-18, TOURING XP 1000 '15-19, TOURING 850 SP '15-19, SCRAMBLER '15-18, 850/XP 1000 HIGHLIFTER '16-19, 850/850 SP '15-18
- » 2881424 • \$179⁹⁹
X2 570 '15-19, TOURING 570 SP '15-19, TOURING 570 '15-19, ETX '15, 570 SP '15-19, 570 '15-19, 570 6X6 '17-19, 450 H.O. '16-19

PLOW MOUNT

- » 2879634 • \$209⁹⁹
POLARIS ACE® '14-16, POLARIS ACE® 570 SP '16, POLARIS ACE® 570 '15-16
- » 2882107 • \$209⁹⁹
POLARIS ACE® 900 XC '17-19, POLARIS ACE® 570 SP '17, POLARIS ACE® 570 '17-19, POLARIS ACE® 500 '17-19
- » 2879632 • \$179⁹⁹
X2 850 '11-12, X2 550 '10-14, TOURING 850 '10-14, TOURING 550 '10-14, 850/850 SP '09-14, 550 '09-14
- » 2879633 • \$179⁹⁹
TOURING 570 '14, TOURING 500 '13, 800 '12-14, 570 '14, 500 H.O. '12-13, 500 '12-14, 400 H.O. '12-14

2 SELECT A FRAME & ANGLE OPTIONS

GLACIER® PLOW FRAME

- » 2879630 • \$259⁹⁹
ALL SPORTSMAN® & POLARIS ACE® MODELS
For use with Glacier® Pro Sportsman® and Polaris ACE® plow systems

GLACIER® PRO PLOW HYDRAULIC ANGLE SYSTEM

- Angle your plow blade with the push of a button so you can clear more snow or other material
- » 2879635 • \$569⁹⁹
Power Controller Recommended (2880836)
For use with Glacier® Pro Sportsman® and Polaris ACE® plow systems

POWER CONTROLLER

- Allows the rider to control plow angle and blade height from the seat
- » 2880836 • \$104⁹⁹
ALL POLARIS ACE® MODELS



3 CONFIGURE PLOW

POLARIS® HD 3500 LB. WINCH

See page 22.

POLARIS® HD 2500 LB. WINCH

See page 23.

PLOW WINCH ROPE

- Improved durability for plow use vs. steel cable
- Thicker than standard synthetic rope
- 8' (2.4m) of 0.25" (6mm) braided rope
- » 2878483 • \$30⁹⁹
FOR USE WITH 2500 LB & 3500 LB WINCHES

4 SELECT A BLADE

GLACIER® PLOW BLADES

- Requires plow blade frame for mounting (sold separately)
- Includes plow blade and metal wear bar
- » 66" • POLY • 2880269 • \$419⁹⁹
- » 60" • STEEL • 2879638 • \$259⁹⁹
- » 52" • STEEL • 2879639 • \$219⁹⁹
FITS ALL SPORTSMAN® AND POLARIS ACE®

GOT TRACKS?



GLACIER® PRO PLOW TRACK EXTENSION

- » 2879719 • \$189⁹⁹
- Plow extension for use when using the prospector pro track system and Glacier® Pro Sportsman® or Polaris ACE® plow system

FOR USE WITH GLACIER® PRO SPORTSMAN® AND POLARIS ACE® PLOW SYSTEMS

SELECT ACCESSORIES

PLOW BLADE SNOW DEFLECTOR

- » 66" • 2879866 • \$84⁹⁹
- » 60" • 2871808 • \$64⁹⁹

QUICK RELEASE SKID SHOES

- Helps prevent blade wear
- Hardened steel for industrial strength
- » 2877245 • \$20⁹⁹

WEAR BARS

- Protect your plow blade and minimize wear on the actual blade by installing Wear Bars
- » 66" • 2879867 • \$54⁹⁹
- » 60" • 2871806 • \$41⁹⁹
- » HD 66" • 2879868 • \$104⁹⁹
- » 52" • 2877210 • \$36⁹⁹

COIL SPRING SPACER

- Keep the front end of the vehicle up and improve ride quality when using a plow on strut or A-arm vehicles
- » 2872655 • \$16⁹⁹

PLOW MARKER

- Helps driver monitor plow blade position
- Sold in pairs
- » 2872726 • \$30⁹⁹

SHEAR PIN REPLACEMENT

- Direct replacement for a Glacier® Pro ATV Plow System Shear Pin
- » 2205063 • \$14⁹⁹

PRO ARMOR®



TIRES

Polaris® and Pro Armor® developed a deep partnership thanks to having similar histories and passion for producing products that enhance vehicle performance. Each wheel and tire Pro Armor® designs and engineers for Polaris® off-road vehicles perform perfectly in the intended environment for its intended use. Developed, tested, and produced in partnership so you can tackle the terrain ahead.



10-PLY

Pro Armor® builds the toughest tires to keep you running when the terrain turns tough. A higher ply rating means added protection. Choose your tire and ply rating based on use and overall performance needs.

DUAL COMPOUNDS

You don't ride or drive in just one type of terrain, so Pro Armor® builds certain tires with multiple wear zones. A dual-durometer design allows the tire to wear better with softer outer lugs and harder inner lugs.

TRIPLE-BELTED SIDEWALLS

Sidewalls can be a vulnerable area of any off-road tire. Rocks jump out at your machine and tear into sidewalls. Thanks to reinforced construction in this critical area, Pro Armor® resists when others fail.

TORTURE-TESTED TOUGH

Pro Armor® pushes beyond normal-use testing, and blows by extreme-use testing. The duty cycle developed by Pro Armor® engineers puts other tires to shame. When you mount a set of Pro Armor® tires, be assured they're ready for rugged terrain.

PRO ARMOR® ATTACK	347 LB
MAXXIS® BIGHORN 2.0	162 LB
MAXXIS® BIGHORN	150 LB

3,000 MILE RATED

Pile on the miles with Pro Armor® tires. Every tire is designed and constructed with longevity in mind. With ratings of 3,000 miles and beyond, you are assured long life and performance.

TIRE: **DUAL-THREAT**

WHEEL: **BUCKLE ACCENT**

KNOW YOUR TIRES

DIMENSIONS
28" x 9" R14
TIRE HEIGHT | TIRE WIDTH | WHEEL DIAMETER

TREAD DEPTH
A deeper tread means more grip and better performance

WEIGHT
A lighter tire makes for improved vehicle performance

PLY RATING
Indicates the overall load capability of the tire

SIDEWALL BELTS
Sidewall belts increase your resistance to sidewall punctures

LOAD RATING
Tires with higher load ratings can handle more weight

PADDLE DEPTH
Increases grip and performance in the sand

TRAIL



FRONT

REAR

PRO ARMOR® DUAL-THREAT

Engineered with dual-compound technology and radial construction to offer revolutionary off-road performance in all terrains. The lateral-grip compound on the outer edges of the tire has a softer durometer rubber for cornering performance and superior grip. The long-wearing compound in the middle of the tire has harder durometer rubber for increased traction during acceleration, straight line stability, and overall longer tread life.

14" 26" x 9" R14 • FRONT • 5416340 • \$169⁹⁹
26" x 11" R14 • REAR • 5416341 • \$179⁹⁹

	TREAD DEPTH	WEIGHT	PLY RATING	SIDEWALL BELTS	LOAD RATING
FRONT	16mm	27 lbs	10	3	910 lbs
REAR		30 lbs			1,100 lbs



WHEEL SIZE

14"

UTILITY



WHEEL SIZE

14" 12"



PRO ARMOR HARVESTER®

- All-around workhorse with tread life of 5,000 miles
- Tread pattern designed to withstand anything from the farmyard and to the pastures to the trail
- With 10-Ply, it can carry the load day in and day out

14" 27" x 10" R14 • FRONT/REAR • 5415965 • \$189⁹⁹
12" 26" x 8" R12 • FRONT • 5416396 • \$179⁹⁹
12" 26" x 10" R12 • REAR • 5415966 • \$189⁹⁹

PRO ARMOR PRESERVE™

- Turf-friendly for areas where low impact from tire tread is needed
- Exceptionally quiet-running tire

14" 27" x 10" R14 • FRONT/REAR • 5416348 • \$189⁹⁹
12" 26" x 8" R12 • FRONT • 5416403 • \$179⁹⁹
12" 26" x 10" R14 • REAR • 5416402 • \$189⁹⁹

PRO ARMOR XD-K

- 26" Aramid fiber-belted tire can tackle any terrain
- Unique full-face tread design
- Harder durometer lugs promotes for extended wear increasing tire life

12" 26" x 9" R12 • FRONT • 5415756 • \$205⁹⁹
12" 26" x 11" R12 • REAR • 5415757 • \$216⁹⁹



FRONT / REAR

PRO ARMOR ATTACK

- The best all-purpose tire for all-season traction in any terrain
- Unique full-face tread design
- Harder durometer lugs promote extended wear, increasing tire life

14" 26" x 9" R14 • FRONT • 5415613 • \$144⁹⁹
14" 26" x 11" R14 • REAR • 5415614 • \$159⁹⁹

	TREAD DEPTH	WEIGHT	PLY RATING	SIDEWALL BELTS	LOAD RATING
FRONT	23mm	28 lbs	8	3	910 lbs
REAR		32 lbs			1,320 lbs



WHEEL SIZE

14"

	TREAD DEPTH	WEIGHT	PLY RATING	SIDEWALL BELTS	LOAD RATING
26" FRONT		24 lbs			855 lbs
26" REAR	16mm	32 lbs	10	3	1,320 lbs
27" FRONT/REAR		32 lbs			1,320 lbs

	TREAD DEPTH	WEIGHT	PLY RATING	SIDEWALL BELTS	LOAD RATING
26" FRONT		24 lbs			855 lbs
26" REAR	16mm	26 lbs	10	3	1,320 lbs
27" FRONT/REAR		28 lbs			1,320 lbs

	TREAD DEPTH	WEIGHT	PLY RATING	SIDEWALL BELTS	LOAD RATING
FRONT	31.7mm	28 lbs	8	3/1 Aramid	935 lbs
REAR		32 lbs			1,330 lbs

SNOW



FRONT / REAR

PRO ARMOR WHITEOUT

- Extra wide tires for flotation in snow
- Tread pattern designed for superior snow traction with limited digging

14" 27" x 14" R14 • FRONT/REAR • 5416032 • \$279⁹⁹

	TREAD DEPTH	WEIGHT	PLY RATING	SIDEWALL BELTS	LOAD RATING
27" R14	16mm	27 lbs	8	3	935 lbs



WHEEL SIZE

14"

MUD



FRONT

REAR

PRO ARMOR DAGGER

- From the trails to the pits, this tire gets you through it all
- Deep, self-cleaning lug and wide tire design for exceptional mud pit performance
- Rounded profile and full lug pattern for on-trail comfort

14" 27" x 9" R14 • FRONT • 5415617 • \$219⁹⁹
14" 27" x 11" R14 • REAR • 5415618 • \$229⁹⁹

	TREAD DEPTH	WEIGHT	PLY RATING	SIDEWALL BELTS	LOAD RATING
FRONT	38mm	32 lbs	8	3	1,100 lbs
REAR		40 lbs			1,170 lbs



WHEEL SIZE

14"



BEADLOCK INCLUDED



BEADLOCK REQUIRED



FORGED BEADLOCK RINGS

- Only used on REBLR wheels. 14" beadlock rings
- Sold individually

VooDoo Blue
14" • 1522244-619 • \$84⁹⁹

Machined
14" • 1522244-266 • \$84⁹⁹

White
14" • 1522244-133 • \$84⁹⁹

Tndy Red
14" • 1522244-293 • \$84⁹⁹

Orange Crush
14" • 1522244-589 • \$84⁹⁹

TIRE SEALANT

1 Gallon
2830485 • \$72⁹⁹

5 Gallon
2830486 • \$298⁹⁹

5 Gallon Pump
2830487 • \$133⁹⁹

32 oz
2830484 • \$20⁹⁹



AMPLIFY

ACCENT: FRONT 14" x 7" • 1522956-266 **\$144⁹⁹**
REAR 14" x 8" • 1522957-266 **\$159⁹⁹**
MATTE BLACK: FRONT 14" x 7" • 1522956-458 **\$124⁹⁹**
REAR 14" x 8" • 1522957-458 **\$134⁹⁹**

BUCKLE

ACCENT: FRONT 14" x 7" • 1522544-266 **\$144⁹⁹**
REAR 14" x 8" • 1522545-266 **\$159⁹⁹**
MATTE BLACK: FRONT 14" x 7" • 1522544-458 **\$124⁹⁹**
REAR 14" x 8" • 1522545-458 **\$134⁹⁹**

COMBAT

(BEADLOCK RINGS INCLUDED)

ACCENT: 14" x 7" • 1523284 **\$209⁹⁹**
MATTE BLACK: 14" x 7" • 1523283 **\$199⁹⁹**

REBLR (REQUIRES BEADLOCK RINGS)

ACCENT: FRONT 14" x 7" • 1522238-458 **\$219⁹⁹**
REAR 14" x 8" • 1522239-458 **\$219⁹⁹**

SIXR

MATTE BLACK: FRONT 14" x 7" • 1521507-521 **\$114⁹⁹**
REAR 14" x 8" • 1521508-521 **\$124⁹⁹**
LUSTER: FRONT 14" x 7" • 1521507-410 **\$144⁹⁹**
REAR 14" x 8" • 1521508-410 **\$149⁹⁹**

SHACKLE

ACCENT: FRONT 14" x 7" • 1522546-266 **\$144⁹⁹**
REAR 14" x 8" • 1522547-266 **\$144⁹⁹**
MATTE BLACK: FRONT 14" x 7" • 1522546-458 **\$124⁹⁹**
REAR 14" x 8" • 1522547-458 **\$124⁹⁹**

SPLIT

MATTE BLACK: FRONT 14" x 6" • 1522542-458 **\$124⁹⁹**
REAR 14" x 8" • 1522543-458 **\$134⁹⁹**

WHITEOUT

MATTE BLACK: 14" x 10" • 1522958 **\$179⁹⁹**

COMBAT REPLACEMENT 14" BEADLOCK RING



PART #

Matte Black - Replacement Only used on Combat 1523146-458 \$54⁹⁹

14" SETS

TIRES	ATTACK	DAGGER	DUAL-THREAT 26"	PRESERVE 27"	HARVESTER 27"	WHITEOUT 27"
WHEELS						
AMPLIFY Accent	2882390 \$1,239 ⁹⁹	2882392 \$1,499 ⁹⁹	2883138 \$1,289 ⁹⁹	2883208 \$1,339 ⁹⁹	2882388 \$1,339 ⁹⁹	
AMPLIFY Matte Black	2882391 \$1,139 ⁹⁹	2882393 \$1,399 ⁹⁹	2883139 \$1,189 ⁹⁹	2883209 \$1,239 ⁹⁹	2882389 \$1,239 ⁹⁹	
BUCKLE Accent	2881335 \$1,239 ⁹⁹	2881337 \$1,499 ⁹⁹	2883140 \$1,289 ⁹⁹	2883203 \$1,339 ⁹⁹	2882383 \$1,339 ⁹⁹	
BUCKLE Matte Black	2881336 \$1,139 ⁹⁹	2881338 \$1,399 ⁹⁹	2883141 \$1,189 ⁹⁹	2883204 \$1,239 ⁹⁹	2882384 \$1,239 ⁹⁹	
COMBAT Accent <small>*BEADLOCKS PRE-MOUNTED</small>			2883217 \$1,599 ⁹⁹			
COMBAT Matte Black <small>*BEADLOCKS PRE-MOUNTED</small>			2883216 \$1,499 ⁹⁹			
REBLR Matte Black <small>*BEADLOCKS SOLD SEPARATELY</small>	2881381 \$1,289 ⁹⁹	2881383 \$1,549 ⁹⁹				
SHACKLE Accent	2881347 \$1,239 ⁹⁹	2881349 \$1,499 ⁹⁹	2883142 \$1,289 ⁹⁹	2883205 \$1,339 ⁹⁹	2882385 \$1,339 ⁹⁹	
SHACKLE Matte Black	2881348 \$1,139 ⁹⁹	2881350 \$1,399 ⁹⁹	2883143 \$1,189 ⁹⁹	2883206 \$1,239 ⁹⁹	2882386 \$1,239 ⁹⁹	
SIXR Luster	2881359 \$1,239 ⁹⁹	2881362 \$1,499 ⁹⁹				
SIXR Matte Black	2881360 \$1,139 ⁹⁹	2881363 \$1,399 ⁹⁹	2883144 \$1,189 ⁹⁹	2883207 \$1,239 ⁹⁹	2882387 \$1,239 ⁹⁹	
SPLIT Matte Black	2881404 \$1,139 ⁹⁹	2881405 \$1,399 ⁹⁹	2883145 \$1,189 ⁹⁹			
WHITEOUT R14 Matte Black						2882382 \$1,859 ⁹⁹

LUGS



10MM X 1.25 HEX LUG NUTS

- » 2877385 • 4 HEX LUG NUTS • \$12⁹⁹
- » 2877384 • 16 HEX LUG NUTS • \$30⁹⁹

Sportsman™ XP

3/8" - 24 HEX LUG NUTS

- » 2876754 • 4 HEX LUG NUTS • \$12⁹⁹
- » 2877409 • 16 HEX LUG NUTS • \$30⁹⁹

Polaris ACE™, SPORTSMAN™ 450/570

REPLACEMENT CAPS



POLARIS™ CAPS

- » 1521509-410 • LUSTER • \$10⁹⁹
 - » 1521509-521 • MATTE BLACK • \$10⁹⁹
- AMPLIFY, BUCKLE, COMBAT, REBLR, SHACKLE, SIXR, SPLIT, WHITEOUT
- » 1522243-410 • LUSTER • \$20⁹⁹
 - » 1522243-458 • MATTE BLACK • \$20⁹⁹
- THRASHER



PRO ARMOR™ CAPS

- » 5453209-410 • LUSTER • \$10⁹⁹
 - » 5453209-458 • MATTE BLACK • \$10⁹⁹
- AMPLIFY, BUCKLE, COMBAT, REBLR, SHACKLE, SIXR, SPLIT, WHITEOUT
- » 1523015-410 • LUSTER • \$10⁹⁹
 - » 1523015-458 • MATTE BLACK • \$10⁹⁹
- THRASHER

ALL-TERRAIN TRACTION

It's tough to make Sportsman® and Polaris ACE® even more versatile than they already are. But with a set of Prospector Pro® Tracks, you'll do just that. Tread through deep snow without concern.

Polaris®-specific gearing provides 1:1 ratio to:

- Minimize track slip, providing better climbing ability and improved traction in deep snow
- Improve top speed over prior models by approximately 5%
- Reduce operating RPM for a quieter ride
- Improve driveline durability, which allows vehicle to run at a lower RPM, decreasing engine wear

Polaris® Exclusive optimized hub geometry that minimizes feedback and eases steering effort

Lightweight design provides for better flotation, eases steering effort, and provides better vehicle control

New front dual stabilizer for improved stability

Flexible lug design provides the highest level of deep snow performance by lifting up in deep snow as opposed to digging down



PROSPECTOR PRO
TRACK SYSTEM



POLARIS® INTERACTIVE DIGITAL DISPLAY 2.0



1. Speedometer
2. Real-Time Clock
3. Compass
4. Tachometer
5. Coolant Temperature
6. Gear Position
7. Odometer Trip Meter
8. Fuel Level Indicator
9. 4x4 Indicator

STANDARD FEATURES

- Control of Bluetooth® audio media streaming with track and artist display
- Exporting capabilities for created tracks and waypoints from the display to USB drive
- Course-up arrow option with rotating background map now available
- Distance to a selected waypoint shown on the map screen
- Automatic day/night brightness change based on time of day and day of year
- New riding screen with increased visibility to important diagnostics, gear indicator enlarges on gear change
- High resolution, 4.3" full color LCD display
- Bluetooth® connectivity allows you to pair your smart phone and check missed calls, text message, battery life and signal strength
- Diagnostics screen displays vehicle fault codes (NEW: Voltage and engine temp faults will pop up and turn red at critical levels)
- GPS connectivity offers exact location information including elevation, latitude/longitude, and compass bearings

» 2881554 • \$799⁹⁹

POLARIS ACE®, SPORTSMAN XP®, SPORTSMAN® SP

Must purchase Install Kit, information below

POLARIS® INTERACTIVE DIGITAL DISPLAY INSTALL KIT

- Includes all installation hardware and harnesses

» 2880536 • \$159⁹⁹

XP 1000 '15-16, TOURING XP 1000 '15-18, TOURING 850 SP '15-18, TOURING 570 SP '15-19, 850/850 SP '15-16, 570 SP '15-19, 570 6X6 '17-19, 450 H.O. '18-19, 570 '18-19 — Non-High Lifter models

» 2880537 • \$74⁹⁹

POLARIS ACE® 900 XC '17-19, POLARIS ACE® 900 SP '16, POLARIS ACE® 570 SP '16-17, POLARIS ACE® 570 '15-19, POLARIS ACE® 500 '17-19, POLARIS ACE® '14-16

» 2882275 • \$159⁹⁹

XP 1000 '17-18, 850/850 SP '17-18



GPS connectivity offers exact location information, including elevation, latitude/longitude, and compass bearings

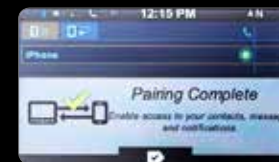

Bluetooth® functionality allows you to see your missed calls and text messages on the display



TPS, RPM, and ground speed playback for up to 90 seconds to easily monitor your vehicle's performance

1 SELECT A MOUNT

PROSPECTOR PRO® MOUNT

- Dual bogie wheels manage weight properly & deliver a great ride & outstanding traction in snow

» 2879457 • \$439⁹⁹

850 (NON-EPS) MY15-18, 850 SP MY15-18, XP 1000 MY15-16, SCRAMBLER 850 MY13-18, SCRAMBLER 1000 MY15-18, TOURING 850 SP MY15-19, TOURING XP 1000 MY15-19

» 2879497 • \$439⁹⁹

SPORTSMAN® ETX, 570 MY14-19, 570 EPS MY15-19, 570 SP MY15-19, TOURING 570 MY14-19, TOURING 570 SP MY15-19, X2 570 MY15-19

» 2882109 • \$439⁹⁹

XP 1000 MY17-18, XP 1000 (NON-EPS) MY18

- High Clearance Track Mount Kit
- Track sold separately

» 2879751 • \$439⁹⁹

POLARIS ACE® MY14-16, POLARIS ACE® 570 MY15, POLARIS ACE® 570 MY16 SP (EPS), POLARIS ACE® 900 SP (EPS)

» 2883019 • \$439⁹⁹

POLARIS ACE® 500/570 '17 (NON-EPS), POLARIS ACE® 500 '17 (EPS)

2 SELECT A KIT

PROSPECTOR PRO® TRACKS

- Polaris® track systems deliver the utmost in performance and productivity, with absolutely no compromise of vehicle cargo capacity or pulling power.

» 2879720 • \$4,199⁹⁹

850 (NON-EPS) MY15-18, SCRAMBLER 850 MY13-18, XP 1000 (NON-EPS) MY18

» 2881003 • \$4,199⁹⁹

850 SP MY15-18, XP 1000 MY15-16, SCRAMBLER 1000 MY15-18, TOURING 850 SP MY15-19, TOURING XP 1000 MY15-19, XP 1000 MY17-18

- They deliver the best in performance, reliability, durability and value in every season.

» 2881025 • \$4,199⁹⁹

570 SP MY15-19, TOURING 570 SP MY15-19, X2 570 MY15-19, POLARIS ACE® 570 SP (EPS) MY16, POLARIS ACE® 570 (EPS) MY17, POLARIS ACE® 900 SP (EPS)

» 2880020 • \$4,199⁹⁹

SPORTSMAN® ETX, 570 MY14-19, 570 (EPS) MY15-19, TOURING 570 MY14-19, POLARIS ACE® MY14-16, POLARIS ACE® 570 MY15, POLARIS ACE® 500/570 (NON-EPS) MY17

PROSPECTOR PRO® TRACK SYSTEM (6X6)

- Includes Track Mount & Track Kit

» 2882169 • \$5,999⁹⁹

570 6X6 MY17-19

QUICKTAP BATTERY POSTS

- Easy-to-access terminal posts give you quick access to the battery power

- Ideal for charging your battery, powering a temporary accessory, or when you need to offer an unexpected jump-start

- Connection posts feature covers to protect terminals when not in use

» 2882110 • \$54⁹⁹

X2 570 '15-19, TOURING 570 '14-19, 570 SP '15-19, 570 '14-19, 570 6X6 '17-19



INTRODUCING

RIGID®

ADVANCED TECH

Rigid® lights are driven by Aluminum PCB Smart Boards™ with copper thermal conductive pads, gold-plated electrical contacts, 6063-T5 aircraft aluminum extruded housings treated with Alodine® corrosion preventive, and Tiger Drylac® UV protection polyester powder coating.

EXCLUSIVE OPTICS

RIGID® hand-selects the brightest high-tech LEDs from the best manufacturers. The LEDs shine through patented optics that maximize total light output and efficiency. RIGID® lights feature impact-resistant polycarbonate lenses for a 100% water/dustproof seal.

PRO ARMOR®



RUGGED STYLING DURABLE CONSTRUCTION

Pro Armor® lights are designed to be big and beefy with an aggressive style all their own. Housed in IP67 marine-grade rated UV Polyester powder-coated with precision-cast end panels and oversized, extruded aluminum heat sinks to keep the temperature down.

MASSIVELY BRIGHT

Counting up to 66 3-5 watt Cree® LEDs pushing over 11,000 lumens, Pro Armor® lights are some of the brightest in the industry. All that power is directed through heat-dissipating aluminum printed circuit boards for streamlined heat management.

RIGID® LIMITED LIFETIME WARRANTY* BREAK YOUR LIGHT AND RIGID® WILL REPLACE OR REPAIR IT FOR LIFE

750 M

500 M

250 M

750 M

500 M

250 M

RIGID® SR-SERIES PRO DRIVING LED

LUMENS: 4,752

» 2883128 • \$349⁹⁹

Comes in a pair

RIGID® SR-SERIES PRO FLOOD LED

LUMENS: 3,168

» 2883126 • \$174⁹⁹

Comes in a pair

RIGID® SR-SERIES PRO SPOT LED

LUMENS: 3,168

» 2883127 • \$174⁹⁹

Comes in a pair

RIGID® SR-SERIES PRO 10" COMBO LED

LUMENS: 7,920

» 2883123 • \$269⁹⁹

RIGID® SR-SERIES PRO 10" FLOOD LED

LUMENS: 7,920

» 2883122 • \$269⁹⁹

RIGID® SR-SERIES PRO 10" SPOT LED

LUMENS: 7,920

» 2883121 • \$269⁹⁹

PRO ARMOR® 20" DUAL

LUMENS: 11,252

» 2883107 • \$399⁹⁹

Only fits POLARIS ACE®

PRO ARMOR® CUBE FLOOD

LUMENS: 1,300

» 2882312 • \$84⁹⁹

Each or single light

PRO ARMOR® CUBE SPOT

LUMENS: 1,400

» 2882076 • \$84⁹⁹

Each or single light

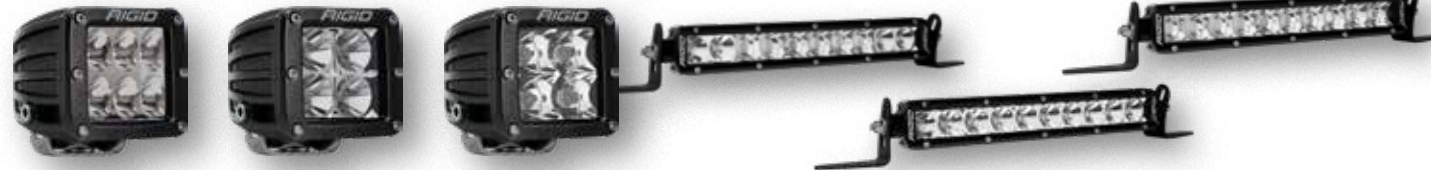

ACCENT LIGHTING KIT

- Set includes four LED pods
- Durable off-road ready construction that is both dust- and water-resistant

SINGLE ACCENT LIGHT

- Durable off-road ready construction that is both dust- and water-resistant
- Features Cree® LED for a long-lasting, brilliant light

COLOR	LIGHTING KIT	SINGLE LIGHT
RED	2880500 • \$159 ⁹⁹	2880532 • \$36 ⁹⁹
BLUE	2880506 • \$159 ⁹⁹	2880533 • \$36 ⁹⁹

ALL SPORTSMAN® MODELS AND POLARIS ACE®



BLUE XENON HEADLIGHT BULBS

- More than 50% brighter than stock bulbs
- » 2876464 • \$27⁹⁹
- XP '09-14, SPORTSMAN® '05-14

WIRING HARNESSES

LED LIGHT BAR HARNESS

- » 2882320 • \$54⁹⁹
- ALL SPORTSMAN® MODELS

LED HARNESS WITH TWO CONNECTORS

- Y-Harness requires 2882320 or 2879859 to control two cube lights with one switch
- » 2879860 • \$15⁹⁹

LED LIGHT BAR HARNESS

- » 2879859 • \$54⁹⁹
- ALL POLARIS ACE® MODELS

* If RIGID® determines, in its sole discretion, that your product is defective in material or workmanship, RIGID® will honor your warranty claim. In some cases the product will be replaced, depending on the specific time frame of the purchase. If the product is repaired, all parts, labor, and return shipping may be covered by RIGID®.

OFF-ROAD GRADE AUDIO

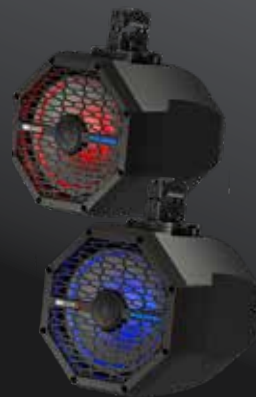

AUDIO PODS **POLARIS ACE**

- Two 8" coaxial speakers with 1" titanium tweeters in weatherproof enclosures
- Self-powered 200-watt per speaker output
- Backlit LED illumination selectable between red and blue
- Rotating, low-profile, rubber isolated mounts
- Durable black satin finish

» 2883739 • \$829⁹⁹
ALL POLARIS ACE[®] MODELS



BLUETOOTH[®] AUDIO REMOTE **POLARIS ACE**

- Bluetooth[®] technology allows you to play music through speakers of choice
- Mount anywhere and control music with easy-to-use push-button pad

» 2883113 • \$134⁹⁹
ALL POLARIS ACE[®] MODELS



MTX[®] OVERHEAD AUDIO POD **POLARIS ACE**

- Bluetooth[®] connectivity for wireless audio
- USB port for charging mobile devices in waterproof storage locker
- LCD display shows audio information; convenient LED lights shine toward rider
- Auxiliary connection through headphone jack
- Dual 6" speakers and tweeters that direct sound toward rider
- Installs in less than 15 minutes; includes all wiring
- Durable, sealed, hard plastic black housing
- Can be used with a roof and windshield; not compatible with Overhead Storage Bag

» 2879703 • \$499⁹⁹
ALL POLARIS ACE[®] MODELS



SOUND BAR 4 **POLARIS ACE**

- Dual mid-range/mid-bass speaker and two dedicated tweeters
- Integrated, self-powered amplifier for easy installation
- Bluetooth[®] or wired audio input with variable output
- Large, easy-to-use external controls
- Aluminum, black finish housing with low profile, clamp-on mounts
- Includes mounts, audio bar, waterproof connections, and instructions

» 2881230 • \$399⁹⁹
ALL POLARIS ACE[®] MODELS
Requires Audio Harness [2882280]
» 2882280 • \$74⁹⁹



WATERPROOF BLUETOOTH[®] AUDIO **POLARIS ACE** **SPORTSMAN**

- Kit includes four mounting configurations
- Mounts easily to the handlebars or roll cage or fits in your dashboard storage area
- IPX4 -rated for water and dust resistance
- Internal LiPo rechargeable battery provides 12 hours of music between charges

» 2880458 • \$259⁹⁹
ALL SPORTSMAN[®] & POLARIS ACE[®] MODELS



BE PREPARED AND GET MORE DONE



POLARIS® SPORTSMAN® & POLARIS ACE® ESSENTIAL ACCESSORIES

NEW 2" X 30' RECOVERY STRAP

- Heavy duty webbing
- 18,000 Lb. Breaking Strength / 9,000 Lb. Max. Vehicle Weight
- Built in strap wrap - easy storage
- Loops sewn in to webbing
- 1 Strapbag



» 2884033 • \$54⁹⁹

NEW 2" X 20' 10,000 LB RATCHET STRAP

- Heavy duty webbing
- 10,000 Lb. Maximum Load / 3,300 Lb. Working Load
- Floating D-Rings
- Double J-Hooks



» 2884032 • \$30⁹⁹

NEW 1.5" X 15' 5,500 LB RATCHET STRAP

- Heavy duty webbing
- 5,500 Lb. Maximum Load / 1,833 Lb. Working Load
- 2 Pack



» 2884031 • \$41⁹⁹

SHOCKSTRAP

- » 2883295 • 1.5" X 7' (2 PACK) \$69⁹⁹
- » 2883296 • 1.5" X 15' (2 PACK) \$79⁹⁹

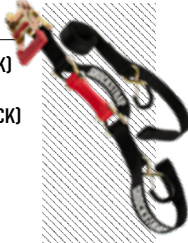

LOCK & RIDE PLUNGER

» 2876420 • \$20⁹⁹
ALL SPORTSMAN® AND POLARIS ACE®



LOCK & RIDE D-RING PLUNGER

» 2881544 • \$25⁹⁹
ALL SPORTSMAN® AND POLARIS ACE®

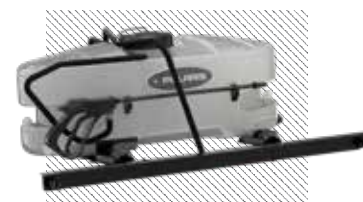

SPORTSMAN® BOOM SPRAYER - 15 GAL

» 2882266 • \$419⁹⁹
ALL SPORTSMAN® MODELS EXCEPT TOURING



HANDLEBAR HAND WARMERS

- Low profile black switch **NEW**
- Keep both hands warm while riding
- Complete kit includes all wiring

» 2877363 • \$59⁹⁹
ALL SPORTSMAN® MODELS

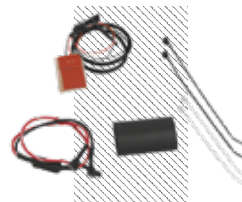

THROTTLE/THUMB WARMERS

- Low profile black switch **NEW**
- Keeps throttle thumb warm
- Complete kit includes all wiring

» 2877364 • \$46⁹⁹
ALL SPORTSMAN® MODELS



HANDLEBAR-MOUNTED MIRROR

- For added safety on or off the trail

» 2877222 • \$36⁹⁹
ALL SPORTSMAN® MODELS



LICENSE PLATE KIT

- Includes numbers & letters

» 2873270 • \$13⁹⁹
ALL SPORTSMAN® MODELS



RIDE & REPAIR ESSENTIALS KIT

- 12-volt DC portable air compressor
- Tire repair kit with 6 plugs
- Basic first-aid kit with bandages, scissors, safety pins, and more
- 12-volt jumper cables
- Duct tape - 300mm x 1 roll
- Zip ties - 150mm length
- Electrical tape
- Ratchet strap - 50mm
- Microfiber cloth
- Carry bag

» 2881207 • \$104⁹⁹

TOTAL FREEDOM REALIZED



POLARIS ACE® 900 XC
BLACK PEARL

Run your favorite trail in the machine you want that's built the way you want. Accessorize your Polaris ACE® 900 to express your passion, and step up your experience. Roofs, windshields, lower doors, and more await your vision.

SHOWN WITH:

- A. AUDIO PODS • 2881227
- B. LOWER DOOR EXTENSIONS • 2880272
- C. LOCK & RIDE CARGO BOX • 2881447
- D. XC FRONT BUMPER • 2882258
- E. LOCK & RIDE FLIP-DOWN WINDSHIELD
HARD COAT POLY • 2882443
- F. LOCK & RIDE SPORT ROOF - POLY • 2881147

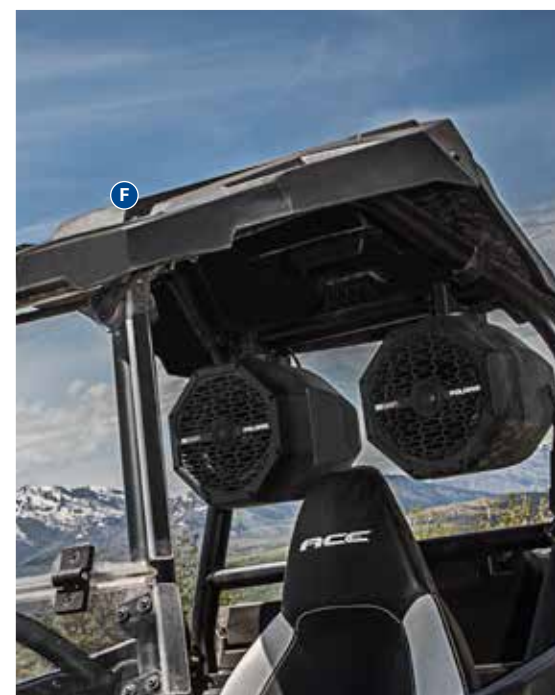

TAKE ON

THE TRAIL



POLARIS ACE 570 SP
GHOST GRAY

POLARIS ACE® 150

THE ONLY SINGLE SEAT
YOUTH ATV WITH A
FULL CAB FRAME



Make it happen. Build it the way you want. Write a story of freedom and adventure on the trail in your Polaris ACE® 570. It's there for the taking. What are you waiting for?

SHOWN WITH:

- A. FOLDING SIDE MIRRORS • 2881517
- B. **LOCK & RIDE** SPORT ROOF - POLY • 2881147
- C. MTX® OVERHEAD AUDIO POD • 2879703
- D. **LOCK & RIDE** MID WINDSHIELD - POLY • 2879694
- E. LOWER DOOR EXTENSION • 2880272
- F. PRO ARMOR® WHEEL & TIRE SET: SIXR - LUSTER & ATTACK • 2881359
- G. POLARIS NORTHSTAR® COOLER - 30QT • 2881315

- | | | |
|---|---|---|
| <p>A. POLY ROOF</p> <p>» 2882263 • \$134⁹⁹
POLARIS ACE® 150 '17-19</p> | <p>B. HALF WINDSHIELD</p> <p>» 2882264 • \$104⁹⁹
POLARIS ACE® 150 '17-19</p> | <p>C. FRONT & REAR BRUSHGUARD</p> <p>» 2882472 • \$104⁹⁹
POLARIS ACE® 150 '17-19</p> |
|---|---|---|

COMFORTABLE AND CAPABLE



LOCK & RIDE
FLIP-DOWN WINDSHIELD
- HARD COAT POLY

• In its up position, experience full protection from wind, mud, rain, or whatever you encounter

» 2882443 • \$309⁹⁹

POLARIS ACE® '14-16, POLARIS ACE® 900 XC '17-19, POLARIS ACE® 900 SP '16, POLARIS ACE® 570 SP '16-17, POLARIS ACE® 570 '15-19, POLARIS ACE® 500 '17-19



A SPORT DOORS

- Steel frame and strong plastic exterior
- Premium fit and finish; no cutting, welding, or drilling required
- Add style with custom POLARIS ACE® Sport Door Graphics (sold separately)

» 2881429 • \$519⁹⁹

POLARIS ACE® '14-16, POLARIS ACE® 900 XC '17-19, POLARIS ACE® 900 SP '16, POLARIS ACE® 570 SP '16-17, POLARIS ACE® 570 '15-19, POLARIS ACE® 500 '17-19

B LOWER DOOR EXTENSIONS

- Extensions install on Sport Doors (2879697, sold separately) and create a single, integrated door unit
- Extensions feature strong, durable steel frame with black hard-plastic exterior

» 2880272 • \$309⁹⁹

POLARIS ACE® '14-16, POLARIS ACE® 900 XC '18-19, POLARIS ACE® 900 SP '16, POLARIS ACE® 570 SP '16, POLARIS ACE® 570 '15-19, POLARIS ACE® 500 '18-19



CANVAS CAB

• Cab provides riders with protection and enhanced comfort for a more enjoyable riding experience

• Included are: canvas roof/rear panel and canvas doors

• Components can be used to suit rider preference and the day's conditions, i.e., doors can be easily removed to suit conditions

• Doors and rear panel feature clear plastic windows for excellent visibility

• Doors feature aluminum frames with durable canvas exterior and durable, reliable hinges and latches

• Requires the use of accessory Full Poly Windshield (2879693; sold separately)

• Requires the removal of accessory Polaris ACE® Sport Doors (2879697) if previously installed

» 2880646 • \$829⁹⁹

POLARIS ACE® '14-16, POLARIS ACE® 900 XC '17-19, POLARIS ACE® 900 SP '16, POLARIS ACE® 570 SP '16-17, POLARIS ACE® 570 '15-19, POLARIS ACE® 500 '17-19



LOCK & RIDE **FULL WINDSHIELD - POLY**

• Windshield is made of impact- and shatter-resistant 0.177" polycarbonate with hard coat on both sides

» 2879693 • \$289⁹⁹

POLARIS ACE® '14-16, POLARIS ACE® 900 XC '17-19, POLARIS ACE® 900 SP '16, POLARIS ACE® 570 SP '16-17, POLARIS ACE® 570 '15-19, POLARIS ACE® 500 '17-19



LOCK & RIDE **MID WINDSHIELD - POLY**

• Provides protection while also allowing airflow to reach the rider

• Strong, durable, impact-resistant polycarbonate

» 2879694 • \$134⁹⁹

POLARIS ACE® '14-16, POLARIS ACE® 900 XC '17-19, POLARIS ACE® 900 SP '16, POLARIS ACE® 570 SP '16-17, POLARIS ACE® 570 '15-19, POLARIS ACE® 500 '17-19



LOCK & RIDE **REAR PANEL - POLY**

• Can be used with other accessories such as roof, cargo bags, etc.

» 2879696 • \$189⁹⁹

POLARIS ACE® '14-16, 570 SP '15-16, 570 '16

» 2881774 • \$189⁹⁹

POLARIS ACE® 900 XC '17-19, POLARIS ACE® 900 SP '16, POLARIS ACE® 570 SP '17, POLARIS ACE® 570 '17-19, POLARIS ACE® 500 '17-19

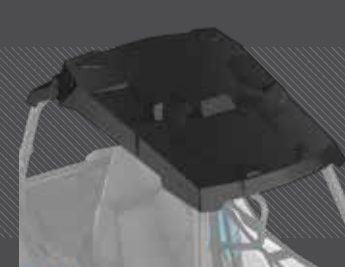

LOCK & RIDE
SPORT ROOF - POLY

• Works with Rear Rops Extender 2881154

» 2881147 • \$209⁹⁹

POLARIS ACE® '14-16, POLARIS ACE® 900 XC '17-19, POLARIS ACE® 900 SP '16, POLARIS ACE® 570 SP '16-17, POLARIS ACE® 570 '15-19, POLARIS ACE® 500 '17-19

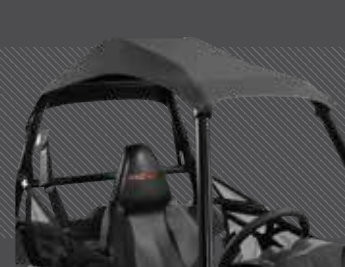

CANVAS ROOF

• Roof attaches securely to vehicle frame using integrated, self-locking mounting hardware

» 2879692 • \$134⁹⁹

POLARIS ACE® '14-16, POLARIS ACE® 900 XC '17-19, POLARIS ACE® 900 SP '16, POLARIS ACE® 570 SP '16-17, POLARIS ACE® 570 '15-19, POLARIS ACE® 500 '17-19



SIDE MIRRORS

• Hinges feature breakaway design for tight trail conditions and easy trailering

» 2881517 • \$159⁹⁹

POLARIS ACE® '14-16, POLARIS ACE® 900 XC '17-19, POLARIS ACE® 900 SP '16, POLARIS ACE® 570 SP '16-17, POLARIS ACE® 570 '15-19, POLARIS ACE® 500 '17-19



REAR VIEW MIRROR

• Can be used in conjunction with accessories such as roof, windshield, etc.

» 2879712 • \$64⁹⁹

POLARIS ACE® '14-16, POLARIS ACE® 900 XC '17-19, POLARIS ACE® 900 SP '16, POLARIS ACE® 570 SP '16-17, POLARIS ACE® 570 '15-19, POLARIS ACE® 500 '17-19

PROTECT YOUR RIDE

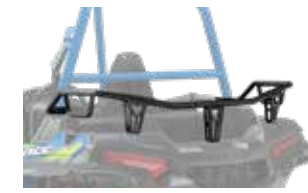

BED EXTENDER

- Creates up to 28 gallons of storage volume on your storage bed
 - Adds 4.5" of height to the rear perimeter of storage bed
 - Steel construction
- » 2882886 • **\$159⁹⁹**
ALL POLARIS ACE[®] MODELS



SUBZERO HARNESS

- Exclusive controlled deceleration tech
 - Easy one-click buckle
 - Secure restraint allows for improved vehicle control
- » 2882281 • **\$189⁹⁹**
POLARIS ACE[®] 500 '18-19, POLARIS ACE[®] 570 '18-19, POLARIS ACE[®] 900 XC '18-19

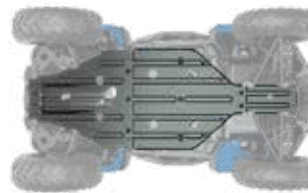

SKID PLATE

- Strong, durable, lightweight 3/8" HMW (high-molecular weight) polyethylene construction
- » 2880543 • **\$339⁹⁹**
POLARIS ACE[®] '14-16, POLARIS ACE[®] 900 SP '16, POLARIS ACE[®] 570 SP '16-17, POLARIS ACE[®] 570 '15-19, POLARIS ACE[®] 500 '17-19

FRONT RACK EXTENDER

- Increase front rack carrying capacity
 - 4"-tall support design around the front and side perimeter of the rack
 - Steel construction
 - Angular design enhances the look of your machine
 - Easily mounts with four bolts
- » 2882885 • **\$104⁹⁹**
ALL POLARIS ACE[®] MODELS



XC BUMPER

- Contoured steel tube design fits perfectly and flows with the sculpted design cues of the Polaris ACE[®] 900 XC
- » FRONT • 2882258 • **\$144⁹⁹**
POLARIS ACE[®] 900 XC '17-19



XC BUMPER

- Contoured steel tube design fits perfectly and flows with the sculpted design cues of the Polaris ACE[®] 900 XC
- » REAR • 2882259 • **\$134⁹⁹**
POLARIS ACE[®] 900 XC '17-19



EXTREME BRUSHGUARD

- Strong 1.25" (3.2cm) diameter steel tube construction with a durable, scratch-resistant black powder-coated finish
- » FRONT • 2882504 • **\$239⁹⁹**
POLARIS ACE[®] '14-16, POLARIS ACE[®] 900 SP '16, POLARIS ACE[®] 570 SP '16-17, POLARIS ACE[®] 570 '15-19, POLARIS ACE[®] 500 '17-19



EXTREME BRUSHGUARD

- Strong 1.25" (3.2cm) diameter steel tube construction with a durable, scratch-resistant black powder-coated finish
- » REAR • 2882924 • **\$159⁹⁹**
POLARIS ACE[®] '14-16, POLARIS ACE[®] 900 SP '16, POLARIS ACE[®] 570 SP '16-17, POLARIS ACE[®] 570 '15-19, POLARIS ACE[®] 500 '17-19



FENDER FLARE KIT

- Extends bodywork additional 3" for extra protection from mud and water
- » 2879718 • **\$259⁹⁹**
POLARIS ACE[®] 900 SP '16, POLARIS ACE[®] 570 SP '16-17, POLARIS ACE[®] 570 '15-17, POLARIS ACE[®] 500 '17, POLARIS ACE[®] '14-16



LOW PROFILE ROCK SLIDERS

- Low-profile design hugs bodywork without compromising ground clearance
- » 2881151 • **\$159⁹⁹**
POLARIS ACE[®] 900 SP '16, POLARIS ACE[®] 570 SP '16-17, POLARIS ACE[®] 570 '15-17, POLARIS ACE[®] 500 '17, POLARIS ACE[®] '14-16
Expanding Anchor Technology - minimal tools required



NERF BARS

- 5" kick-out protects the side of the vehicle, acting as a buffer between the vehicle and obstacles
- » 2879700 • **\$209⁹⁹**
POLARIS ACE 900 SP '16, POLARIS ACE 570 SP '16-17, POLARIS ACE 570 '15-17, POLARIS ACE 500 '17, POLARIS ACE '14-16



BODY ARMOR

- Helps protect vehicle plastics
- » 2882087 • **\$219⁹⁹**
POLARIS ACE[®] '14-16, POLARIS ACE[®] 570 SP '16-17, POLARIS ACE[®] 570 '15-17, POLARIS ACE[®] 900 SP '16, POLARIS ACE[®] 500 '17



LOCK & RIDE[®] REAR CARGO BOX

- Installs without tools using twin Lock & Ride[®] plungers, locks into vehicle's cargo space
 - Handles make it easy to carry Cargo Box to and from vehicle
 - D-rings on top of box serve as tie-down points for bungees, straps, cargo nets, etc.
- » 2881447 • **\$259⁹⁹**
POLARIS ACE[®] '14-16, POLARIS ACE[®] 900 XC '17-19, POLARIS ACE[®] 900 SP '16, POLARIS ACE[®] 570 SP '16-17, POLARIS ACE[®] 570 '15-19, POLARIS ACE[®] 500 '17-19



SIDE BAGS

- Bag has a zippered compartment to securely hold cargo and a mesh outside pocket
 - Sold as a set of 2
- » 2880542 • **\$84⁹⁹**
ALL POLARIS ACE[®] MODELS WITHOUT DOORS



TRAIL BAG

- Securely holds cargo in four zippered compartments
 - Adjustable Velcro[®] straps secure bag to vehicle frame
- » 2879705 • **\$74⁹⁹**
POLARIS ACE[®] '14-17

ENGINEERED TO MAXIMIZE THE LIFE OF YOUR RIDE

All Polaris® fluids—from AGL to Demand Drive Fluid—are developed for your vehicle. Trust the only fluids perfectly engineered for your needs.



SPECIFIC NEEDS, SPECIFIC OILS

Polaris® invests millions in engine development, and part of that investment is making sure its lubricants—critical to engine performance—are the right formula for your specific engine. The amount of testing data and engineering resources used in developing Polaris® lubricants would overwhelm an aftermarket company. Therefore, the aftermarket must produce an oil to an industry-wide standard that must account for a variety of operating parameters.

PS-4 is designed specifically for Polaris® 4-cycle engines and has high film strength and wear protection under extreme loads and temperatures. Exclusive anti-wear additives protect engine parts with extra rust and corrosion protection.



Everything needed to change your oil! The correct filter & amount of oil for your vehicle.



PS-4 OIL CHANGE KIT (OIL & FILTER)		PS-4 [EXTREME DUTY] OIL CHANGE KIT (OIL & FILTER)	
PART NUMBER	VEHICLE FITMENT	PART NUMBER	
2202166	RANGER®/RZR®/SPORTSMAN® 570, TWIN 600, TWIN 700, TWIN 800	2879004	
2879323	RANGER®, POLARIS GENERAL®, RZR® 900/1000, RS1	2879324	
2877473	RANGER®/SPORTSMAN® 300-500, SPORTSMAN®/SCRAMBLER® 500/850/1000	2878924	
2881696	RZR® TURBO	2881697	



PS-4 FULL-SYNTHETIC OIL

PS-4 is optimal for ambient operating temperatures of -40° F to 100° F

- » 1 QT. • 2876244
- » 1 GAL. • 2876245
- » 16 GAL. • 2876247



PS-4 EXTREME-DUTY FULL-SYNTHETIC OIL

PS-4 Extreme Duty is optimal for ambient operating temperatures of 0° F to 130° F

- » 1 QT. • 2878920
- » 1 GAL. • 2878919
- » 16 GAL. • 2879003



ORV MAINTENANCE KIT

This convenient kit includes everything you need, in the correct fluid volumes, to properly maintain your drive train, and keep your vehicle in top operating condition.

- Includes: 1.5 qt.s AGL, 1 qt. Angle Drive Fluid, 1 pint Demand Drive Fluid, 1-3 oz. tube of All-Season Grease
- » 2880425

PROVEN PROTECTION

Powersports grade, full-synthetic base oils and proprietary additive systems outperform leading automotive and aftermarket engine oils in 75 hour severe duty engine testing.

PS-4 vs. AUTO OIL

60% MORE ROD END BEARING WEAR PROTECTION WITH PS-4



WORN & GROOVED

+ 40% LESS CYLINDER WEAR WITH PS-4

+ 30% LESS GRAFAL WEAR* WITH PS-4

*The purpose of the grafal coating is primarily to decrease friction and protect the piston from wear.



PS-4 RACE PROVEN PERFORMANCE

"The Baja 1000 is probably the toughest race in the world! In the brutal Baja desert there are so many things that can ruin your race it is great to know that Polaris Engineered Lubricants will never let us down.

We trust in the Polaris products like the PS-4 motor oil to protect our machines vitals, they are a critical part of a winning formula."

**BILL SCHUELER
CREW CHIEF JAGGED X**

MAINTENANCE FLUIDS



OIL

Maximum protection for your 4-cycle engine. Exclusive anti-wear additives protect your engine and extend the life of engine components.

Change every 100 hours, 6 months or 500 miles.



AGL

Extreme pressure additives protect gears, drive chain, and bearings from scoring and wear. Unlike typical gear case oils, AGL's unique viscosity range allows instant flow and film protection in extreme cold or high heat environments.

Change every 100 hours, 12 months or 1000 miles.

» 1 QT. • 2878068

» 1 GAL. • 2878069

» 2.5 GAL. • 2878070

» 55 GAL. • 2879594

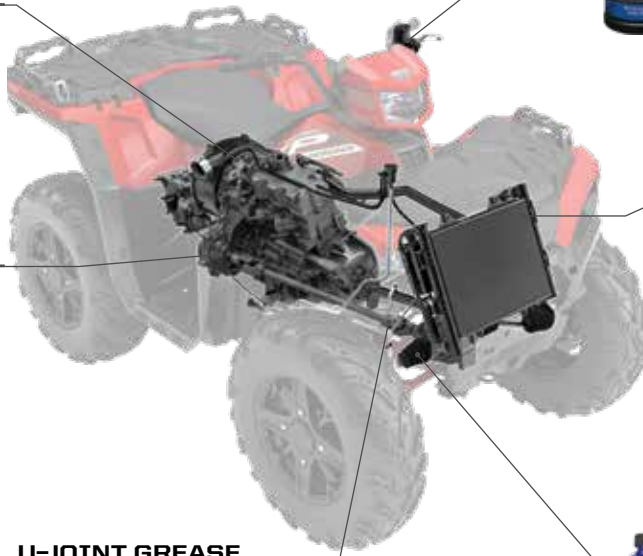

DOT 4 BRAKE FLUID

A high-quality brake fluid designed for use in Polaris' hydraulic brakes. Superior high-temp characteristics plus anti-corrosive additives extend the life of brake system components and provide consistent, positive braking.

Change every 200 hours, 2000 miles or every 2 years.

» 12 OZ. • 2872189



ANTI-FREEZE

Organic acid technologies to prevent corrosion on metal components, eliminate scaling, and maximize cooling system performance.

Change every 60 months.

» 1 QT. • 2880514

» 1 GAL. • 2880513

» 55 GAL. • 2880512



U-JOINT GREASE

A heavy-duty lubricant formulated with molybdenum disulfide to accept the high shock applications of Polaris' ATV shaft drive universal joints.

Add every 50 hours, 3 months or 500 miles.

» 3 OZ. • 2871515

» 14 OZ. • 2871551



DEMAND DRIVE FLUID

Provides positive 4WD engagement in extreme cold or high heat conditions. Unique friction additives protect internal components under heavy loads and promote positive engagement.

Change every 100 hours or yearly.

» 1 QT. • 2877922

» 2.5 GAL. • 2877923



PREMIUM GAS SHOCK OIL

» 1 QT. • 2870995

» 2.5 GAL. • 2872279

Fox® REBUILDABLE SHOCKS

10WT GAS SHOCK OIL

» 1 QT. • 2874124

Walker EVANS® REBUILDABLE SHOCKS

CHAIN LUBRICANT

» 16 OZ. AEROSOL

2872348

ALL-SEASON GREASE TUBE

» 3 OZ. • 2871322

» 14 OZ. • 2871423

ANGLE DRIVE FLUID

» 1 QT. • 2876160

» 2.5 GAL. • 2872276

Sportsman®, RANGER®, RZR® ANGLE DRIVE GEAR CASE SYSTEMS

CARBON CLEAN

Prevents ethanol corrosion, stabilizes fuel, and cleans fuel injectors, piston ring lands, intake systems, and combustion chambers. Helps maintain peak HP and improves fuel economy.

» 12 OZ. • 2881413

ADVANCED FUEL TREATMENT

Prevents ethanol corrosion and stabilizes fuel for up to 2 years. Dual-antioxidant formula protects against gum and varnish for easy starting.

» 12 OZ. • 2881416

» 2.5 GAL. • 2881417

LUBRICANT ACCESSORIES



GREASE GUN KIT

» 2871312 • \$39⁹⁹

Fits 2871322 ALL-SEASON AND 2871322 U-JOINT 3 OZ.



2D BATTERY-OPERATED SIPHON PUMP

• Liquid transfer pumps 5-6 quarts/ min suctioning power

• Use with gas, water, oil, and other non-corrosive liquids

» 2830513 • \$16⁹⁹



FLEX SPOUT

• Convenient easy pour flex spout fits all Polaris' quart, gallon, and 2.5 gallon bottles

» 2871285 • \$3⁴⁹



PUMP

• Attaches to 1- or 2.5-gallon bottle for easy, no-drip dispensing

» 2870465 • \$7⁹⁹

TIRE SEALANT

HOW IT WORKS

Tire sealant remains liquefied inside your tire until a leak develops in the tire or wheel.



Once a leak occurs, the tire sealant rushes out of the tire and quickly creates a permanent solid plug.

The plug maintains the pressure of the tire so you can continue your ride.

PREMIUM TIRE SEALANT

- Instantly seals and repairs rim, bead leaks, and punctures up to 1/4" on standard tires, and 3/4" on heavy ply tires
- Helps maintain air pressure for the life of the tire
- Helps seal the tire bead against the wheel
- 100% water soluble for easy cleanup

- Will not rust, corrode, or pit wheels
- Creates permanent repair
- Remains fluid and effective in temperatures down to -45° F
- Easily installed through existing tire valve stem with valve core removed

» 32 OZ. • 2830484 • \$19⁹⁹

» 1 GALLON • 2830485 • \$69⁹⁹

» 5 GALLON • 2830486 • \$289⁹⁹

» 5 GALLON PUMP • 2830487 • \$129⁹⁹

» 55 GALLON • 2830489

» 275 GALLON • 2830488



24 X 7 COVERAGE | BE PREPARED FOR ANYTHING

NOTHING CAN STOP YOU. COVERAGE WHEN YOU NEED IT.

FIX ON THE GO | TEMPORARY COVERAGE

CV BOOT REPAIR KIT*

- A quick trail side fix to increase trail time.
- The flexible and durable boot material expands over a cone tool for CV boot repairs, without disassembling CV axles.
- Universal fit - works as a temporary fix for most powersports axles.
- All components fit inside the cone, and a cover is provided for compact durable storage.
- Easily fits in a cargo box, attached to the roll cage, in the glovebox, or many other storage locations.



Items shown are contained inside cone

ATV CV BOOT REPAIR KIT

Kit includes the following items:

- (1) Expandable CV Boot
- (1) Reusable Cone Tool
- (2) CV Boot Clamps
- (1) Tube of Silicone Lube
- (1) Grease Packet
- (1) Cone Cover

» 2830528 • \$29⁹⁹

ATV TRAIL BOOT ONLY

» 2830529 • \$14⁹⁹

UTV

» CV REPAIR KIT

2830526 • \$25⁹⁹

» TRAIL BOOT ONLY

2830527 • \$14⁹⁹

SEE HOW THE CV BOOT REPAIR KIT WORKS AT POLARIS.COM/MAINTENANCE-VIDEOS

HOW TO INSTALL

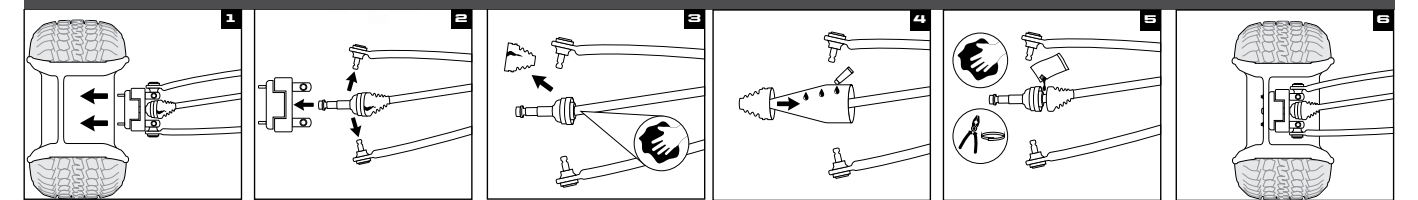

Remove wheel and axle nut

Remove brake caliper, hub, tie rod, & upper & lower ball joints

Remove old boot & clean joint

Spread silicone lube on entire cone tool. Slide boot over cone tool, large end first. See package for outer boot instructions.

Empty the bag of grease into the CV joint/boot, clean sealing points & install clamps

Reassemble tie rod, ball joints, brake caliper, axle nut, tire & wheel

Refer to your owner's manual for further instructions and torque specifications.

*Designed for temporary CV boot repair. Purchase the OEM CV Boot for a permanent repair.

FOR THE LIFE OF YOUR RIDE

THE KEY TO KEEPING YOUR POLARIS® OFF-ROAD VEHICLE PERFORMING as well as the day you brought it home is proper maintenance. Items like belts, filters, and batteries represent only a few of these critical items engineered specifically by Polaris®.

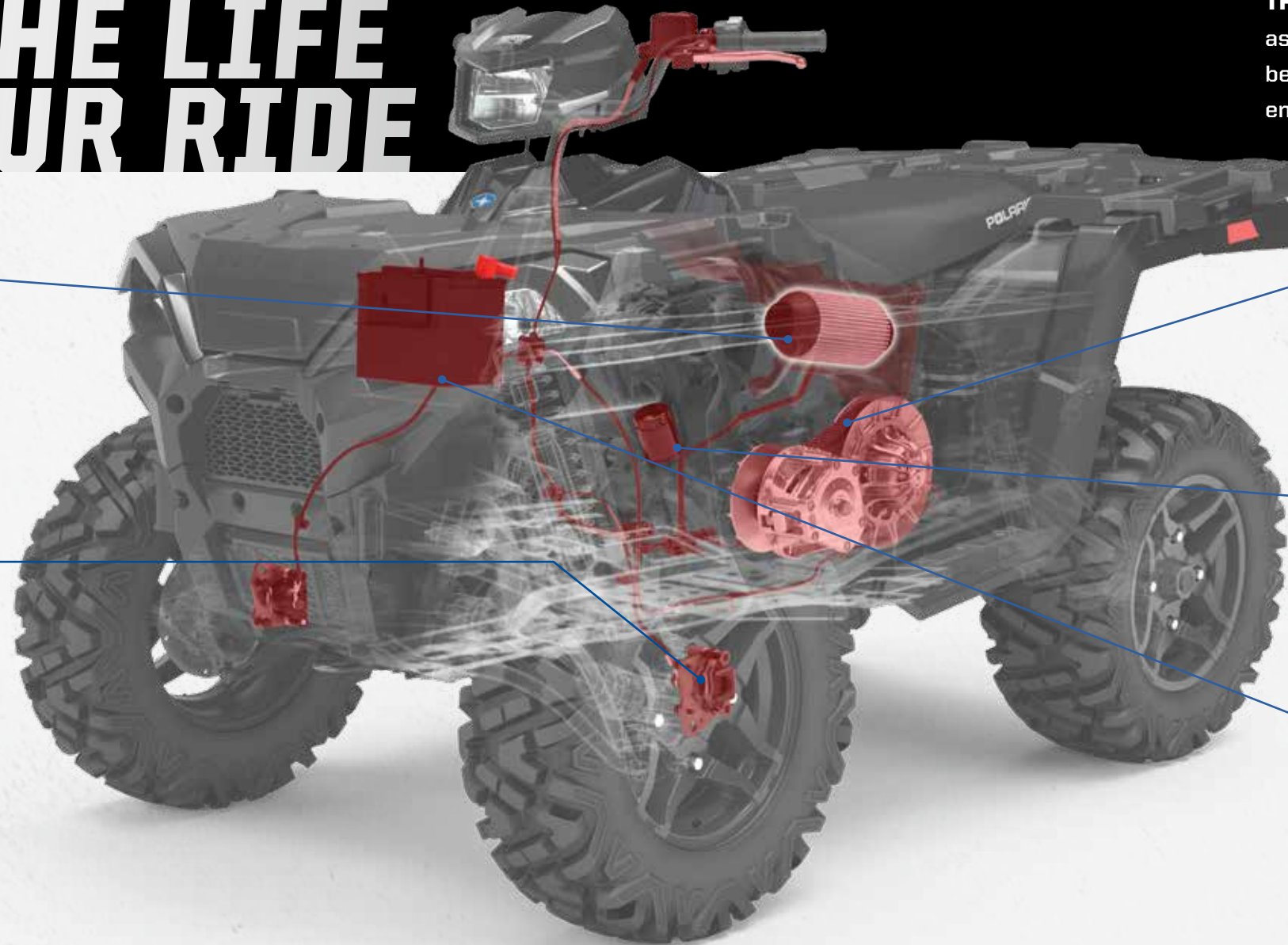

AIR FILTERS

Critical to engine performance and reliability. A clogged air filter can restrict air flow to the engine leading to reduced engine performance. Dirt and debris ingestion can damage the engine leading to reduced engine life or catastrophic failure. Polaris® recommends changing the vehicle's air filter at the specified intervals outlined in the owner's manual, which may be shorter if your vehicle is subject to severe conditions.

BRAKE PADS

Check your brakes if you are close to the recommended service interval, hear grinding when applying the brakes, your vehicle is taking longer to stop or if you have to apply more pressure to your pedal to engage the brakes. Check the brake discs for signs of cracks, excessive corrosion or warping.

If the brake pads are contaminated with oils or grease (petroleum products), brake pads have to be discarded and replaced.

Discs need to be cleaned with brake cleaner or alcohol based cleaner only.

DRIVE BELTS

Polaris Engineered™ belts deliver unmatched performance for your off-road vehicle. Developed and tested on all our engines for all environments and conditions. Check your belt for delamination, hour glassing and glazing.

OIL FILTERS

Change oil filters with every oil change to provide the best protection for your engine. Superior engine protection keeps your engine operating at peak performance. Be sure to follow the suggested service intervals for oil/oil filter changes.

BATTERIES

Never leave a battery unattended during the storage season. To ensure your battery maintains its level of charge when unused for extended periods of time or during freezing weather, the battery should be connected to a BatteryMINDER®. Be sure to check for corrosion from the terminals to the ends of the cables.

MAINTENANCE TIP

BREAK-IN PERIOD

The break-in period for your new Polaris Sportsman® is the first 25 hours of operation, or the time it takes to use the first two tanks of fuel. No single action on your part is as important as a proper break-in period. Careful treatment of a new engine will result in more efficient performance and longer life for the engine. Perform the listed procedures carefully.

NOTICE: Excessive heat build-up during the first three hours of operation will damage close-fitted engine parts. Do not operate at full throttle or high speeds for extended periods during the first three hours of use.

SEE OUR LATEST MAINTENANCE TIPS AT [POLARIS.COM/MAINTENANCE-VIDEOS](https://www.polaris.com/maintenance-videos)



MAINTENANCE SCHEDULE

25 HRS/250 MI

BREAK-IN MAINTENANCE

ENGINE OIL:
CHANGE

GENERAL LUBRICATION:
ALL FITTINGS, PIVOTS, CABLES, ETC.

AIR FILTER:
INSPECT & CLEAN
REPLACE AS NEEDED

EXHAUST SYSTEM:
INSPECT & CLEAN
INSPECT FOR LEAKAGE OR CARBON BUILD UP AT JOINTS
INSPECT & CLEAN SCREEN TYPE SPARK ARRESTOR

50 HRS/500 MI

6 MONTHS

EXHAUST SYSTEM:
INSPECT & CLEAN
INSPECT FOR LEAKAGE OR CARBON BUILD UP AT JOINTS
INSPECT & CLEAN SCREEN TYPE SPARK ARRESTOR

GENERAL LUBRICATION:
ALL FITTINGS, PIVOTS, CABLES, ETC.

DRIVE BELT:
INSPECT & ADJUST
REPLACE AS NEEDED

100 HRS/1000 MI

12 MONTHS

ENGINE OIL:
CHANGE

DRIVE BELT:
INSPECT & ADJUST
REPLACE AS NEEDED

TRANSMISSION FLUID:
CHANGE

EXHAUST SYSTEM:
INSPECT & CLEAN
INSPECT FOR LEAKAGE OR CARBON BUILD UP AT JOINTS
INSPECT & CLEAN SCREEN TYPE SPARK ARRESTOR

150 HRS/1500 MI

18 MONTHS

ENGINE OIL:
CHANGE

BATTERY:
TEST, CLEAN, & CHECK FLUID LEVEL
REPLACE AS NEEDED

DRIVE BELT:
INSPECT & ADJUST
REPLACE AS NEEDED

TIRES:
INSPECT CONDITION & PRESSURE

EXHAUST SYSTEM:
INSPECT & CLEAN
INSPECT FOR LEAKAGE OR CARBON BUILD UP AT JOINTS
INSPECT & CLEAN SCREEN TYPE SPARK ARRESTOR

200 HRS/2000 MI

24 MONTHS

ENGINE OIL:
CHANGE

BRAKE PADS & FLUID:
INSPECT & CLEAN
REPLACE AS NEEDED

SPARK PLUGS:
INSPECT
REPLACE AS NEEDED

EXHAUST SYSTEM:
INSPECT & CLEAN
INSPECT FOR LEAKAGE OR CARBON BUILD UP AT JOINTS
INSPECT & CLEAN SCREEN TYPE SPARK ARRESTOR

350 HRS/3500 MI

30 MONTHS

ENGINE OIL:
CHANGE

BATTERY:
TEST, CLEAN, & CHECK FLUID LEVEL
REPLACE AS NEEDED

DRIVE BELT:
INSPECT & ADJUST
REPLACE AS NEEDED

GENERAL LUBRICATION:
ALL FITTINGS, PIVOTS, CABLES, ETC.

EXHAUST SYSTEM:
INSPECT & CLEAN
INSPECT FOR LEAKAGE OR CARBON BUILD UP AT JOINTS
INSPECT & CLEAN SCREEN TYPE SPARK ARRESTOR

500 HRS/5000 MI

36 MONTHS

ENGINE OIL:
CHANGE

AIR FILTER:
INSPECT, CLEAN
REPLACE AS NEEDED

COOLANT:
CHECK LEVEL
REPLACE EVERY 2 YEARS

GEARCASES:
CHECK OIL LEVEL

EXHAUST SYSTEM:
INSPECT & CLEAN
INSPECT FOR LEAKAGE OR CARBON BUILD UP AT JOINTS
INSPECT & CLEAN SCREEN TYPE SPARK ARRESTOR

CHECK YOUR OWNER'S MANUAL FOR ADDITIONAL RECOMMENDED SERVICE ITEMS AND VEHICLE-SPECIFIC TIMING

SERVICE PARTS

Polaris Engineered™ service parts deliver unmatched performance and fit for your off-road vehicle.

All service parts are developed and tested for your vehicle. **Half shafts, bushings, bearings, decals, side panels, electrical components, and clutching components** are the same parts that are manufactured on the factory lines for each specific vehicle. This ensures it doesn't merely fit your vehicle - it outperforms your expectations!

SHOP FOR SERVICE PARTS ONLINE OR VISIT YOUR POLARIS® DEALER.

OVER
100,000
PARTS
AVAILABLE!



CHECK OUT OUR PARTS FINDER ON POLARIS.COM
FOR EASY PARTS LOOK-UP, PARTS IDENTIFICATION, VIEWS OF ASSEMBLIES & MORE!

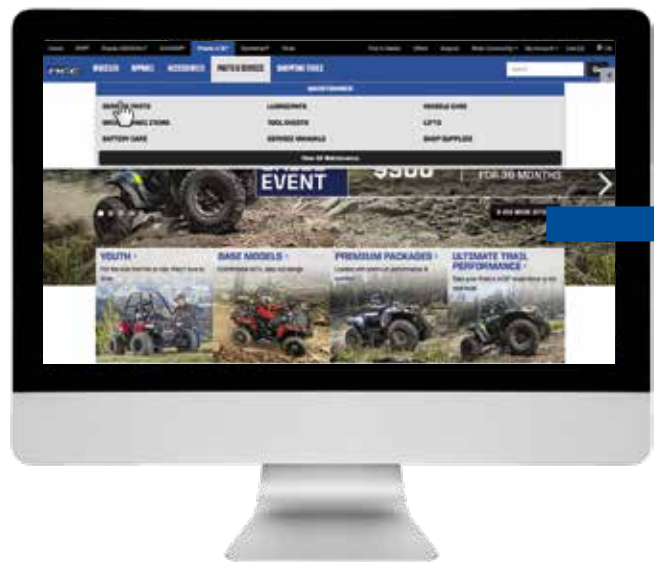

STEP 1

Visit Polaris.com/SPORTSMAN or Polaris.com/ACE

Click "Parts & Service" tab

Click "Service Parts"

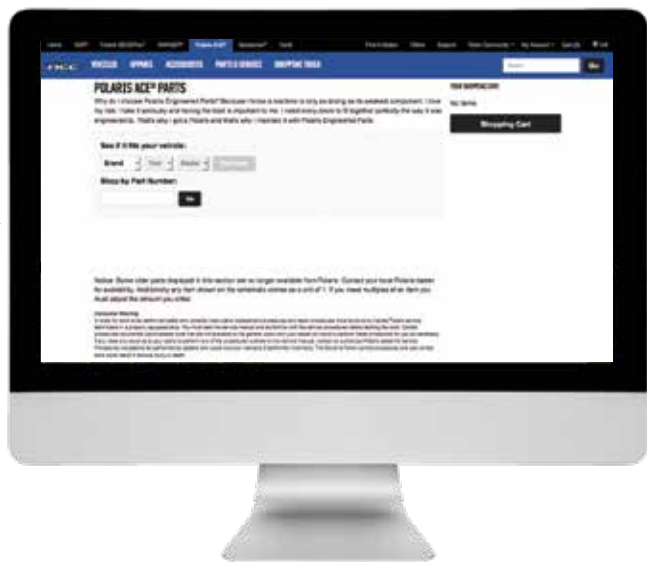

STEP 2

Enter **vehicle year/model** or shop by **part number**



STEP 3

Clearly see what parts are required and **order**

Assembly
DRIVE TRAIN FRONT HALF SHAFT - A17DAAB07 (10004)

A17DAAB07 ACE 800 SONG (2017) (214)

Zoom In Zoom Out

Click and drag to move diagram view

Qty	Part#	Description	Price	Qty	
1	133240	ASM-SHAFT-HALF-FRONT	\$249.99	2	Add
2	209801	K-JOINT, CV (INCL. BALL, INTER RACE, CAGE, BELL)	\$74.99	1	Add
3	209802	K-BOOT, OUTER (INCL. CLAMPS, BOOT, GREASE)	\$16.19	1	Add
4	209803	K-HALF-SHAFT BAR (INCL. SHAFT, CLIPS)	\$29.99	1	Add
5	209804	K-BOOT, INNER (INCL. CLAMPS, BOOT, GREASE)	\$16.19	1	Add
6	209805	K-DOG, INNER (INCL. CLIP, RING, RACE, BALLS, BELL)	\$26.19	1	Add
7		KIT, SNAP RING SET	Contact Dealer		
8	209807	GREASE	Contact Dealer		

Notice: Some older parts displayed in this section are no longer available from Polaris. Contact your local Polaris dealer for availability. Additionally any item shown on the schematic comes as a unit of 1. If you need multiples of an item you must adjust the amount you order.

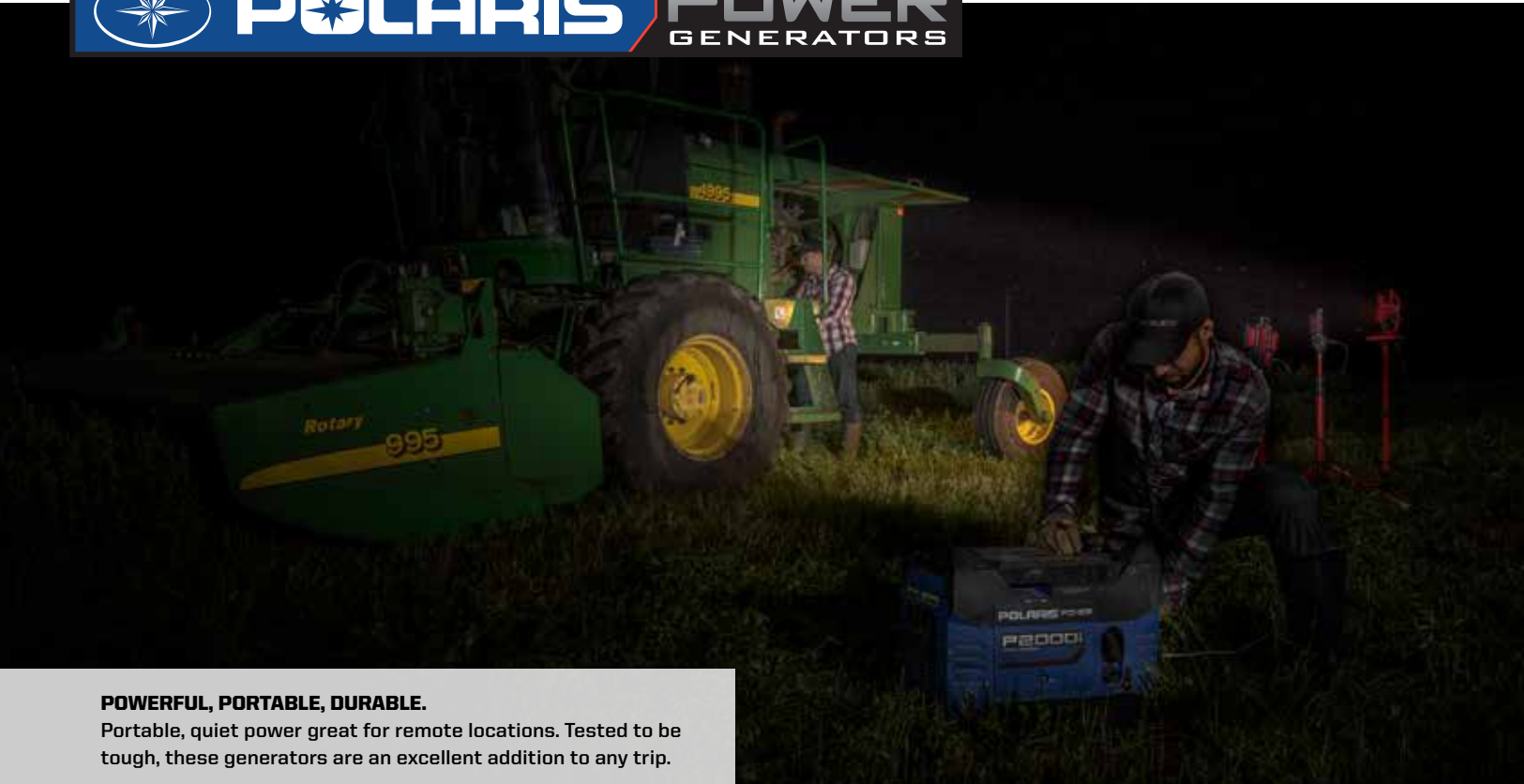

POWERFUL, PORTABLE, DURABLE.

Portable, quiet power great for remote locations. Tested to be tough, these generators are an excellent addition to any trip.

PORTABLE POWER



POLARIS® FLEX JUMPSTARTER

- 12,000 mAh capacity. Two 5V/2.1A USB outputs, 200-lumen flashlight, and a digital battery life monitor. Includes storage case, smart jumper cables, car charger, wall charger, and user guide.
- 1-year limited warranty.
- Jumpstart any engine up to 6.4L. The Polaris® Flex Jumpstarter is small enough to be stored in your glovebox and holds its charge so you can count on it when it's needed.

» 2830495 • \$119⁹⁹

WHICH GENERATOR FITS YOUR NEEDS?

- 1 Add up the running watts of everything you might power at the same time.
- 2 Pick the device with the highest running watts and add its starting watts to the previous total.
- 3 Select a generator with a slightly higher wattage.

	Startup Wattage	Running Wattage
55" LCD TV	0	150
CROCK POT	0	200
RADIO	0	50-200
LAPTOP	0	200-250
625W MICROWAVE	0	625
FRIDGE OR FREEZER	700	700
COFFEE MAKER	1300	800
SUMP PUMP: 1/3 HP	1300	800
BLENDER	1000	1000
ELECTRIC GRIDDLE	0	1500
7 1/4" CIRCULAR SAW	1700	1400
AIR CONDITIONER	1500	1500

POLARIS POWER® INVERTER GENERATORS



P1000i

1000 WATT
PORTABLE / QUIET

- Dual handles and only 36.4 lbs.
- Connect two units together for even more output
- Quieter than casual conversation (54db @ 25%)
- Up to 10 hours on 1 tank of gas

» P13GDGANA • \$549⁹⁹

P2000i

2000 WATT
VERSATILE / LIGHTWEIGHT

- Dual handles and only 53.3 lbs.
- Connect two units together for even more output
- Quieter than casual conversation (54db @ 25%)
- Up to 10 hours on 1 tank of gas

» P13GDGBNA • \$799⁹⁹

P3000iE

3000 WATT
ROBUST / ELECTRIC START

- Locking 360 degree pivoting wheels
- Easy electric start for minimal effort
- Quieter than casual conversation (56db @ 25%)
- Up to 21.5 hours on 3.5 gallons of gas

» P13GDGCNA • \$1,599⁹⁹

GENERATOR ACCESSORIES



POLARIS POWER® COLD WEATHER KIT

- Ensure smooth running of your Polaris® Generator in sub-zero temperatures
- Prevents ice blockage in the crankcase breather tube, which may lead to operational issues including oil leakage
- Installation required, no need to disconnect for warm weather operation
- Exclusively designed for use with Polaris® P1000i & P2000i inverter generators

» 2881433 • \$99⁹⁹



POLARIS POWER® CABLE KIT

- Use a parallel cable kit to easily connect two Polaris Power® generators together to increase the total power available to a load

» 3410281 • \$149⁹⁹



POLARIS POWER® TIE-DOWN LEADS

- Secure your Polaris Power® Generator by inserting the Lock & Ride® Tie Down Leads into the handle and running a strap across to tie down the generator
- Secures Lock & Ride® accepting gear
- Safely provides a point for 1" wide tie-down strap

» 2880959 • \$12⁹⁹



POLARIS POWER® GENERATOR OIL

- Corrosion inhibitors protect against rust and oxidation during long-term storage

» 1 QUART • 2879383



POLARIS POWER® GENERATOR STORAGE COVERS

- Keep your generator looking like new with a strong, durable cover that is resistant to mold, mildew, tears, and abrasions

» 1000 WATT COVER • 2686441
\$29⁹⁹

» 2000 WATT COVER • 2686442
\$34⁹⁹

» 3000 WATT COVER • 2686443
\$39⁹⁹



BatteryMINDER®

ENSURE YOUR RIDE IS READY WHEN YOU ARE!

- Add years of capacity, power and range to new and older batteries, regardless of type or brand
- Never over or under charged in any temperature
- Leave your vehicle connected for months and return to fully charged and conditioned batteries
- Recover older-weak batteries that would normally need to be replaced
- Charge and maintain extra-backup batteries as well as those in your vehicle
- Automatic turn-on, sleeps while keeping your batteries at full-charge
- Easy Push-Button selector to change battery type or time



	BatteryMINDER® 2012 AGM 2 AMP	BatteryMINDER® 1510 1.5 AMP	BatteryMINDER® 1.5 AMP CONVERTIBLE
PRICE	\$99 ⁹⁵	\$64 ⁹⁵	\$74 ⁹⁹
PART NUMBER	2830438	2830404	2830511
VOLTAGE	12	12	12
CHARGING CURRENT	2 AMP	1.5 AMP	1.5 AMP
OVERCHARGE PROTECTION	Yes	Yes	Yes
BATTERIES MAINTAINED AT ONE TIME	6	4	4
WARRANTY	5 Years	10 Years	5 Years
BATTERY COMPATIBILITY	12 Volt Sealed AGM Lead-Acid	12 Volt flooded (filler cap) and sealed maintenance free batteries	12 Volt flooded (filler cap) and sealed maintenance free batteries
COMES WITH	• Non-fused battery clip cord set with Quick Connector	• Ambient temperature sensor (installed) • 12ft. power cord • Battery clip cord set with Quick Connector • Optional Permanent Mounting Tab	• Auto-Temp compensation sensor (installed) • Optional permanent mounting brackets & screws • Battery clips (fully-insulated, aircraft grade, 15A replaceable fuse) • Ring terminal assembly with 15A replaceable fuse
KEY FEATURES	Designed for high performance specialty AGM sealed batteries	Easy to use, economical	Convertible on-vehicle or bench top use

BATTERY MAINTENANCE TIPS

Extend your battery life with a BatteryMINDER® and these tips.

1. Store batteries in a cool, dry location.
2. Check that the battery connections are tight. Cables should not be able to be rotated or shifted by hand.
3. If your battery has a drain tube, make sure it is free of clogs.
4. Clean your battery - use a soft brush to scrub the top of the battery. Use baking soda to remove grease.
5. Connect a BatteryMINDER® after using your vehicle even if the vehicle is in regular use.

BatteryMINDER® ACCESSORIES



BatteryMINDER® VPP-12/12/24 VOLT VEHICLE POWER PLUG

- Allows easy connection to vehicle's battery through lighter or 12/24V power port with replaceable 15 amp fuse.

» 2830518 • \$10⁰⁰



BatteryMINDER® 12' EXTENSION CABLE

- Made with heavy-duty 16 gauge black zip cord featuring automotive SAE bullet connectors

» 2830410 • \$12⁹⁹



BatteryMINDER® MULTI-BATTERY SPLITTER

- A simple, safe, and affordable way to connect two batteries simultaneously for easy battery maintenance

• Includes a set of ring terminals
» 2830409 • \$24⁹⁹



BatteryMINDER® RING TERMINAL KIT

- Features 24-inch long 18-gauge wire
- Plug has standard 5/16" negative and 3/8" positive terminals
- Replaceable 15 amp in-line fuse for circuit protection
- SAE quick connector and cap

» 2830437 • \$9⁹⁹



BatteryMINDER® EZ CONNECT

- Allows for quick and easy connecting and disconnecting of your BatteryMINDER®

• Includes a set of ring terminals
» 2830411 • \$34⁹⁹

LIFT IT SECURELY LIFT IT SAFELY



POLARIS® VEHICLE LIFT

- Get fast, easy access to the underside of your vehicle
- Manual and pneumatic operation available
- Raises vehicle up to 32" to make repairs and maintenance faster and easier

» 1200 LBS • 2830424 • \$699⁹⁹

LIFT ATTACHMENTS

- Add the appropriate attachment to use your lift for all your off-road vehicles

» ATV/POLARIS ACE® • 2830427 • \$169⁹⁹

» SNOWMOBILE • 2830426 • \$169⁹⁹

POLARIS® X3 CREEPER

- Three positions: flat, 45-degree angle or seated work stool
- Helps you perform any repair with ease
- Stay dry and warm away from cold, wet cement floors
- Easily stores away when not in use

» BLACK • 2830429 • \$149⁹⁹



SHOP ACCESSORIES



POLARIS® MAGNETIC PARTS TRAY

» SILVER • 2830432 • \$12⁹⁹



POLARIS® 33" TELESCOPIC MAGNET

» BLACK • 2830435 • \$4⁹⁹



POLARIS® 12" HI-TORQUE RATCHETING DRIVER

» BLACK / BLUE • 2830434 • \$19⁹⁹



POLARIS® LED POCKET FLASHLIGHT

» BLACK • 2830436 • \$24⁹⁹

KEEP IT CLEAN

BRING IT EVERYWHERE

LIFTS, VEHICLE CARE & TRAILERING

CLEAN YOUR VEHICLE

PRE-TREAT

MUD SHIELD® PRE-TREATMENT

- Inhibits the adhesion of dirt, mud, and snow, making cleaning your vehicle faster and easier.

» 16 OZ. AEROSOL • 2830208 • **\$9⁹⁹**

NEVER RUST SPRAY®

- Synthetic formula highly resistant to water protects against rust and corrosion while lubricating metal surfaces.

» 16 OZ. AEROSOL • 2830209 • **\$10⁹⁹**

CLEAN

XP WASH®

- Foaming, highly-concentrated wash easily removes the most stubborn and intense dirt build-up.

» 32 OZ. • 2830203 • **\$10⁹⁹**

XP SPRAY WASH®

- Effortless biodegradable, high-performance wash ideal for removing dirt, oils and carbon—simply spray on, spray off and go.

» 32 OZ. • 2830202 • **\$12⁹⁹**

ALL-PURPOSE CLEANER

- Professional grade, non-streak, foam formula cuts through grease, dirt and film leaving an invisible, dirt-resistant barrier for long-lasting results.

» 16 OZ. • 2830205 • **\$9⁹⁹**

GLASS CLEANER

- Heavy-duty foam non-streak formula cuts through grease, dirt, dried bugs and film leaving a crystal clear dirt-resistant barrier for long-lasting results.

» 16 OZ. • 2830443 • **\$4⁹⁹**

SHINE

POLARIS® POLISH

- Easy protection and shine—spray on, wipe off, and go. For ideal use on painted and plastic surfaces. Contains carnauba wax.

» 12 OZ. • 2830207 • **\$7⁹⁹**

INSTANT SHINE & DETAILER

- Spray and wipe formula—cleans, polishes, and protects plastic and painted surfaces.

» 16 OZ. • 2830204 • **\$8⁹⁹**

CLEAN YOUR SHOP

TOWELS

POLARIS® SHOP TOWELS

» 200 CT WITH DISPENSER 2830402 • **\$22⁹⁹**

» 200 CT REFILL • 2830403 • **\$15⁹⁹**

» 64 CT REFILL • 2830440 • **\$4⁹⁹**



POLARIS® HEAVY-DUTY SCRUBBER WIPES

» 90 CT • 2830441 • **\$19⁹⁹**



PROFESSIONAL GRADE CLEANERS

VEHICLE

VEHICLE & EQUIPMENT WASH

- Concentrated professional grade formula powers through vehicle buildup, dirt and grease with a spot-free rinse. Treat up to 32 gals. Biodegradable product.

» 1 GAL. • 2830417 • **\$16⁹⁹**

» 5 GAL. • 2830422 • **\$59⁹⁹**

SHOP

ALL-PURPOSE CLEANER PLUS

- Professional-grade formula removes built-up stains from shop floors, work benches, and other hard surfaces. VOC-free, environmentally-friendly, and biodegradable.

» 1 GAL. • 2830414 • **\$16⁹⁹**

» 5 GAL. • 2830416 • **\$59⁹⁹**

HD CLEANER & DEGREASER

- Professional-grade, biodegradable, high-foaming formula dissolves and removes tough stains and soils.

» 1 GAL. • 2830418 • **\$19⁹⁹**

» 5 GAL. • 2830420 • **\$79⁹⁹**

TRAILERING



RAMP PRO BY CALIBER®

- Designed for ATVs and UTVs up to 50" wide
 - Integrated grip glides for ultimate traction
 - Folding sides for easy transportation & storing
- » 52" x 90" • 2883005 • **\$399⁹⁹**



ALUMINUM ARCHED LOADING RAMPS

- » 76" x 12" • 2,000 lb • 2875384 • **\$219⁹⁹**
- » 88" x 12" • 3,000 lb • 2875386 • **\$359⁹⁹**



LIGHTWEIGHT TRI-FOLD RAMPS

- Ramp folds up for transport
 - Capacity for up to 1,500 lb
 - Safety straps included
- » 72" x 51" • 2875385 • **\$239⁹⁹**
- » 82" x 51" • 2875860 • **\$279⁹⁹**



FOLDING ALUMINUM ARCHED RAMPS

- Ramp folds up for transport
 - Capacity up to 3,000 lb
 - Safety straps included
- » 88" x 12" • 2875387 • **\$289⁹⁹**

HITCHES

3:1 HITCHES VERSATILE 3 IN 1 FUNCTIONALITY

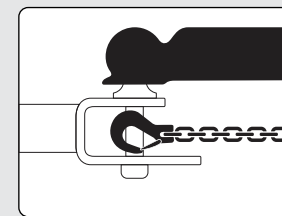

BALL

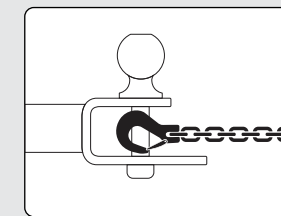

HOOK

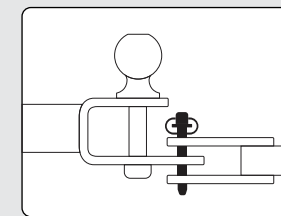

PIN

- Ball, pin and hook design
- Durable steel construction
- Rust resistant, black powdercoated finish
- Removable ball
- Heavy Duty 5/8" pin and clip



NEW HITCH WITH 2" BALL

» 2" x 2" RECEIVER 2830522 • **\$39⁹⁹**

» 1 1/2" x 1 1/4" RECEIVER 2830523 • **\$39⁹⁹**



NEW 1 7/8" BALL

- 1 7/8" replacement ball for hitch
 - Designed to work with 3:1 Hitch
- » 2830524 • **\$9⁹⁹**



RECEIVER HITCH

- » 2" RECEIVER TONGUE 2875320 • **\$41⁹⁹**
- » FRONT HITCH RECEIVER 2878846 • **\$124⁹⁹**



TRAILER BALL 3/4" SHANK

- » 1 7/8" BALL • 2877602 • **\$12⁹⁹**
- » 2" BALL • 2877603 • **\$12⁹⁹**

STRAPS & ROPES

NEW RECOVERY STRAP

- 2" x 30' (18,000 lb)
 - Comes with carry bag
- » 2884033 • **\$54⁹⁹**



NEW RATCHET STRAP

- 1.5" x 15' straps, 2 Pack
 - Heavy duty webbing
 - 5,500 lb. maximum load, 1,833 lb. working load
- » 2884031 • **\$41⁹⁹**



NEW RATCHET STRAP

- 2" x 20' Ratchet Straps
 - Heavy duty webbing, floating D-rings, double J-hooks
 - 10,000 lb. maximum load, 3,300 lb. working load
- » 2884032 • **\$30⁹⁹**



SHOCK STRAPS

- 1.5" 3000 lb breaking strength
 - Keeps tension on tie-down straps to secure load, 2 Pack
- » 1.5" x 15' • 2883296 • **\$79⁹⁹**
- » 1.5" x 7' • 2883295 • **\$69⁹⁹**



COVERS



TRAILERING COVERS BY POLARIS®

- » 2876614 • **\$159⁹⁹**
ALL SPORTSMAN® EXCEPT 300/400, X2, TOURING
- » 2877999 • **\$159⁹⁹**
ALL SPORTSMAN® TOURING

- » 2877998 • **\$159⁹⁹**
SPORTSMAN® X2
- » 2880056 • **\$229⁹⁹**
ALL POLARIS ACE® EXCEPT 900 XC

KINGPIN DIRT 509 GOGGLE

- Quick change lens & triple layer foam
- Anti-fog & anti scratch

» ONE SIZE • \$54⁹⁹
2868671 • LIME
2868668 • ORANGE

ORV RIDING JERSEY

» S-3XL • \$29⁹⁹
2868711 • LIME
2867941 • PINK
2867942 • RED



COOL

SOFTSHELL JACKET

- Lined with 280 grams of fleece for warmth
 - Removable hood
 - Armpit zips for venting
- » S-3XL • \$129⁹⁹

» MEN'S
2869919 • BLUE/ORANGE
2869918 • BLACK

» WOMEN'S
2869921 • CORAL
2869920 • BLACK



WARM



FIND YOUR PERFECT HELMET!

RIDE SAFE - OUR HELMETS ARE DOT/ECE CERTIFIED



509° ALTITUDE CARBON HELMET

- Durable, ultra lightweight, Carbon Fiber
- Full carbon fiber shell
- 1100 grams

» S-4XL • \$399⁹⁹
2867814 • MATTE BLACK
2867815 • GLOSS BLACK



509° ALTITUDE HELMET

- Stylish, Lightweight with 509 Fit and Finish
- Thermoplastic poly alloy out shell
- 1260 grams

» S-4XL • \$229⁹⁹
2868539 • LIME
2867820 • BLUE
2867818 • ORANGE

2867819 • RED
2867817 • GRAY



TENACITY HELMET

- All the style and protection in our most affordable helmet
- Injection molded plastic
- 1450 grams

» XS-3XL • \$109⁹⁹
2868624 • PINK GLOSS
2868620 • BLACK/GRAY
2868622 • BLUE GLOSS

2868619 • BLACK MATTE
2868623 • RED GLOSS
2868621 • LIME GLOSS

PROTECT YOUR HANDS

OFF-ROAD RIDING GLOVES

- As seen in images at left

» S-3XL • \$24⁹⁹
2867937 • PINK
2867933 • GRAY
2868712 • BLUE/LIME

2867936 • RED
2867935 • ORANGE
2867934 • BLUE

BE PREPARED FOR ANYTHING NATURE

THROWS AT YOU

COOLING SHIRTS

- 100% Poly, chemical-free patented fabric from CoolCore®
- Moisture wicking to keep you dry and cool
- UPF 45+

» S-3XL • \$44⁹⁹
» MEN'S
2868753 • GRAY
» WOMEN'S
2868755 • GRAY/PINK



COOL

NEW RAIN SUIT

- Lightweight
- Waterproof
- Packs small
- Removable hood
- YKK® zippers

» JACKET • 2869527
S-3XL • \$109⁹⁹
» PANT • 2869528
S-3XL • \$84⁹⁹



DRY

STAY WARM AND CHARGE YOUR PHONE

NEW HEATED VEST

- Three heat settings for changing weather
 - Down-proof material
 - Removable hood
 - Powered by a small rechargeable battery (included)
 - Battery can be recharged via USB or any 12V outlet
 - Charge a cell phone with the rechargeable battery
 - Machine washable
- » MEN'S • S-3XL • \$199⁹⁹
2869924 • DARK GRAY
» WOMEN'S • S-3XL • \$199⁹⁹
2869923 • DARK GRAY



WARM

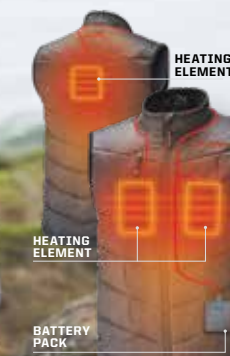



WOMEN'S ASYMMETRICAL HOODIE

» S-3XL • \$54⁹⁹
BLACK • 2868597

WOMEN'S ROSEAU TEE

» S-3XL • \$24⁹⁹
GRAY FROST • 2869559
BLACK • 2868586



MEN'S RETRO LOGO HOODIE

» S-3XL • \$54⁹⁹
BLACK • 2869549
CHARCOAL/LIME • 2868578
GRAY/ORANGE • 2868577

MEN'S RETRO CAP

» ONE SIZE • \$24⁹⁹
NAVY/LIME • 2869543

MEN'S ROSEAU HOODIE

» S-3XL • \$54⁹⁹
CHARCOAL HEATHER • 2869553
NAVY HEATHER • 2868575
OLIVE HEATHER • 2868576



MEN'S LONG SLEEVE TECH 1/4 ZIP

» S-3XL • \$59⁹⁹
BLACK/RED • 2869535
GRAY/LIME • 2869536



MEN'S TRAIL MID LAYER

» S-3XL • \$89⁹⁹
GRAY/BLACK • 2869925

MEN'S TECH MESH BEANIE

» ONE SIZE • \$19⁹⁹
BLACK • 2868650



WOMEN'S CAMO HOODIE

» S-3XL • \$54⁹⁹
CAMO/PINK • 2867898

MEN'S CAMO TECH FULL ZIP

» S-3XL • \$54⁹⁹
CAMO • 2869590



MEN'S RETRO TRUCKER CAP

» ONE SIZE • \$24⁹⁹
RED • 2869540

MEN'S LONG SLEEVE RETRO TEE

» S-3XL • \$39⁹⁹
GRAY • 2868571

WOMEN'S BASEBALL 3/4 SLEEVE TEE

» S-3XL • \$34⁹⁹
WHITE/GRAY • 2869563



PINT GLASS SET OF 2

» 2866265 • \$14⁹⁹

RETRO CLOCK

» 2868662 • \$29⁹⁹



CAMO WATER BOTTLE

» 2867962 • \$19⁹⁹

CAMO COFFEE TRAVEL MUG

» 2867961 • \$24⁹⁹

CAMO BOTTLE KOOZIE

» 2867964 • \$9⁹⁹

CAMO CAN KOOZIE

» 2867963 • \$5⁹⁹

CAMO STEERING WHEEL COVER

» 2868663 • \$14⁹⁹

CAMO BOTTLE OPENER [NOT SHOWN]

» 2867965 • \$9⁹⁹



MEN'S ESTA TEE

» S-3XL • \$19⁹⁹
CHARCOAL HEATHER • 2869552
NAVY • 2869562
BLACK • 2868570

MEN'S FULL ZIP HOODIE

» S-3XL • \$54⁹⁹
BLACK/RED • 2869530
NAVY • 2869532 [NOT SHOWN]

MEN'S RETRO CAP

» ONE SIZE • \$24⁹⁹
CHARCOAL • 2869542



WOMEN'S HEX TEE

» S-3XL • \$24⁹⁹
GRAY FROST • 2869566
NAVY FROST • 2869565

WOMEN'S RETRO CAP

» ONE SIZE • \$24⁹⁹
BLUE • 2869547

WOMEN'S SCRIPT CREW SWEATSHIRT

» S-2XL • \$49⁹⁹
AQUA • 2869557

WOMEN'S RETRO HOODIE

» S-3XL • \$49⁹⁹
NAVY • 2869555



MEN'S ROSEAU TEE

» S-3XL • \$24⁹⁹
CHARCOAL HEATHER • 2869560
HEATHER BLUE • 2867778
ASH HEATHER • 2869561

BUILD YOUR **POLARIS SPORTSMAN**[®]

1 CHOOSE
MODEL

2 CHOOSE
TRIM & COLOR

3 CHOOSE
ACCESSORIES



VISIT POLARIS.COM/SPORTSMAN

TO SEE ALL YOUR OPTIONS & ACCESSORIES
ON YOUR NEW MACHINE FROM EVERY ANGLE!



CONNECT ONLINE
SEARCH "PolarisORV"



KEEP IT COLD.



SEE THE FULL LINE OF COOLERS
INCLUDING THE NEW 15 QT. MODEL
WITH AN EASY CARRY HANDLE

SEE P. 18



POLARIS[®]

MY19 SPTSMN/ACE APP US • 9930477

FIND EVERYTHING YOU'RE LOOKING FOR AT POLARIS.COM/SHOP

UNLESS NOTED, TRADEMARKS ARE THE PROPERTY OF POLARIS INDUSTRIES INC. 509 is a registered trademark of 509, Inc. Amara is a registered trademark of Kuraray Co. Ltd. of Japan. AP-360 is a registered trademark of TK. BatteryMinder is a registered trademark of VDC Electronics Inc. Bluetooth is a registered trademark of Bluetooth SIG, Inc. Break-Up is a registered trademark of Haas Outdoors, Inc. Camoplast is a registered trademark of Camoplast Solideal Inc. CREE is a registered trademark of Cree, Inc. FOX is a registered trademark of Fox Factory Inc. GoPro is a registered trademark of GoPro Inc. Homelink is a registered trademark of Johnson Controls Technology Inc. Kevlar is a registered trademark of E.I. du Pont de Nemours & Company. Kolpin is a registered trademark of Kolpin Outdoors, Inc. Maxxis is a registered trademark of Cheng Shin Rubber Ind. Co. Ltd. MB Quart is a registered trademark of Maxxsonics USA Inc. Moose Utility Division is a registered trademark of LeMans Corporation. Mossy Oak is a registered trademark of Haas Outdoors, Inc. MTX is a registered trademark of Mitek Corporation. OGIO is a registered trademark of Ogio International, Inc. Rigid is a registered trademark of Rigid Hitch, Inc. Velcro is a registered trademark of Velcro Industries B.V. Ltd Co. Netherlands. Walker Evans is a registered trademark of Walker Evans Enterprises Corp. WARN is the registered mark of Warn Industries, Inc. Yeti is a registered trademark of Yeti Coolers, LLC. YKK is a registered trademark of YKK Corporation. Pro Armor is a registered trademark of Polaris Industries Inc. Prices and availability are subject to change at any moment. Copyright © 2018 Polaris Industries. All rights reserved.