

CANADA VERSION



POLARIS®

SPORTSMAN®

2019

ACCESSORIES + APPAREL



FOREVER OUTDOORS

SPORTSMAN® MODELS & ACCESSORIES (FULL LINEUP AT ATV.POLARIS.COM)

POLARIS ACE®

COMMON ACCESSORIES

PARTS & GARAGE

APPAREL & HELMETS

Sportsman® is legendary, giving you the ability to ride harder, go further and do more than any other ATV. From the farm yards to the scenic trails, the Polaris® Sportsman® line-up is chosen by more ATV owners than any other in the industry.

2019 LINEUP

RECREATION & UTILITY



SPORTSMAN® 450 H.O. (EPS)
33HP



SPORTSMAN® 570
44HP



SPORTSMAN® 850 SP
78HP



SPORTSMAN XP® 1000
90HP

TOURING



SPORTSMAN® TOURING 570 (EPS)
44HP

MUD & SPORT



SPORTSMAN XP® 1000 HIGH LIFTER EDITION
85HP



POLARIS ACE® 900 XC
78HP



POLARIS ACE® 150 EFI
15HP



PRO ARMOR® WHEELS & TIRES



POLARIS® PRO HD WINCHES



RIGID® & PRO ARMOR® LIGHTING



GLACIER® PLOW SYSTEMS



2019 POLARIS® SPORTSMAN® ACCESSORIES

POLARIS ENGINEERED® ACCESSORIES	04
WINCHES	08

SPORTSMAN®	
570 • 450	12
XP 1000 • 850	20
SCRAMBLER®	27

POLARIS ACE®	
POLARIS ACE® 900 XC • 570 • 500	30
POLARIS ACE® 150	34

COMMON ACCESSORIES	
ESSENTIALS	34
OFF-ROAD GRADE AUDIO SYSTEMS	35
PRO ARMOR® WHEELS & TIRES	38
PROSPECTOR® PRO TRACKS / TECHNOLOGY	42
GLACIER® PLOW SYSTEMS	44
RIGID® & PRO ARMOR® LIGHTING	46
HUNT	48
POLARIS NORTHSTAR® COOLERS	50

PARTS & GARAGE	
OIL & LUBRICANTS	52
MAINTENANCE	54
SERVICE PARTS	58
POLARIS POWER®	60
GARAGE & TRAILERING	64

APPAREL & HELMETS	
RIDING GEAR	66
CASUALWEAR	68

KEEP YOUR STANDARDS HIGH

DESIGNED

POLARIS® OFFERS THE BROADEST LINEUP OF ACCESSORIES AND MOST INNOVATIVE SOLUTIONS IN OFF-ROAD. EACH ONE IS METICULOUSLY CRAFTED TO MATCH YOUR MACHINE.

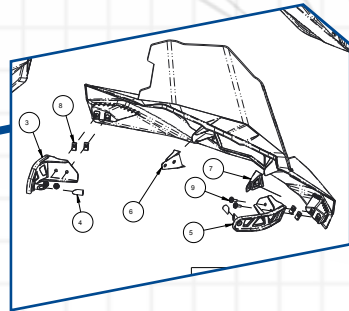

TESTED

BY THE TIME YOU GET THIS GEAR, PROTOTYPES HAVE GONE THROUGH HELL IN OUR LAB AND BEEN EXTENSIVELY TESTED IN THE FIELD. YOU RIDE WITH 100% CONFIDENCE.



TRUSTED

WE'VE EARNED RIDERS' TRUST OVER DECADES AND WE STAND BEHIND OUR WORK. EVERYTHING WITH OUR NAME ON IT COMES WITH A ONE-YEAR WARRANTY.

BACKED BY A



WARRANTY

POLARIS® PARTNERS WITH THE BEST

We choose our partners carefully, selecting only the best in off-road. Every accessory is rigorously tested and validated at Polaris® standards, to ensure seamless integration and performance.

PRO ARMOR®



WHEELS & TIRES P. 38
LED LIGHTS P. 47



RIGID®

LED LIGHTS P. 46



KOLPIN® OUTDOORS

ACCESSORIES P. 48



MBQUART®

OFF-ROAD GRADE AUDIO P. 35

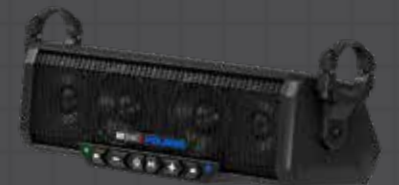

ENGINEERED

FOR MORE

Ensuring Polaris Engineered™ Accessories fit and work in sync with your machine is the most critical phase of testing and validation. With seamless integration, you can trust that any Polaris® accessory you install will enhance your interaction beyond your expectations.



LOCK & RIDE™

CARGO VERSATILITY

Lock & Ride® mounting locations allow for limitless customization to let you work the way you want.

PLUG & PLAY ELECTRICAL

Simple plug & play approach for adding power to Polaris Engineered™ Accessories.

PRO PRO HEAVY DUTY SERIES

WINCHES

INTEGRATED WINCH MOUNT & PRE-WIRED

Designated mounting points and pre-wired contactors ensure a perfect fit and the strongest place to attach the Polaris Engineered™ winch - the most dependable winch for your Sportsman®. With wiring built right into the vehicle, we made this the easiest Sportsman® winch ever made to install.

GLACIER® PLOW SYSTEM

INTEGRATED PLOW MOUNT

The attachment points for the best-in-class Glacier® Plow System are integrated right at the factory and feature an innovative drive-up and go installation process.

SUPERIOR

INTEGRATION

POLARIS
ENGINEERED

POLARIS® PRO HD WINCHES + GLACIER® PLOW SYSTEMS

Right from the factory, your vehicle is built to make essential accessories like winches and plows easy to use day-in and day-out. Mounting brackets are designed into the oversized factory bumper and wiring is routed securely and properly. When it comes to Sportsman®, Polaris Engineered™ Accessories make work easier so you can get more done.



POLARIS® PRO HD FEATURES



Tested **1,200+** pulls at max load, it works when you need it to



Built to withstand **-20° F** temperatures



Sealed motor & heavy duty gears **OPERATE FULLY SUBMERGED UNDERWATER**



RAPID ROPE RECOVERY
5X faster rope retrieval



MILITARY tested & approved

WINCHES

PLOWS

PRE-WIRED CHASSIS

Factory-installed wiring makes the controls simple to install. Mount the winch, connect the wires and trust that everything is routed safely, securely, and properly.

NO NEED TO CUT PANELS

FULLY INTEGRATED MOUNT & WIRING



GLACIER® PLOW SYSTEM



GLACIER® FEATURES

- ✓ Easily engage and disengage the plow system from your Polaris® Sportsman®.
- ✓ No loss of factory ground clearance when not plowing.
- ✓ Don't have to crawl under the machine to release the plow blade from the vehicle.
- ✓ No trimming of vehicle plastic or fascia required to mount plow or winch.



SEE FULL PLOW LINEUP ON PAGE 44
POLARIS.COM/ATVPLOWS



CHOOSE THE
RIGHT WINCH
FOR YOU.



WARRANTY

WINCH TYPES
POLARIS.COM/WINCHES

	PRO PRO HEAVY DUTY SERIES	HID HEAVY DUTY SERIES
		
		
RAPID ROPE RECOVERY	STANDARD	NOT AVAILABLE
AUTO STOP TECHNOLOGY	STANDARD	OPTION
SYNTHETIC ROPE	STANDARD	OPTION
FAIRLEAD	ALUMINUM	STEEL ROLLER
WIRELESS REMOTE	STANDARD	OPTION
HANDLEBAR CONTROL	OPTION	STANDARD
WINCHES AVAILABLE	3,500 LB.	2,500 LB. & 3,500 LB.

PRO PRO HEAVY DUTY SERIES

PREMIUM FEATURES FOR TOP-OF-THE-LINE POWER

INDUSTRY 1ST TECHNOLOGY

RAPID ROPE RECOVERY



1. Set Winch Dial to FREE SPOOL (N) to attach Winch Hook
2. Set Winch Dial to PULL (L) for Winch Mode
3. Set Winch Dial to ROPE RECOVERY (H) for 5x Faster Rope Recovery

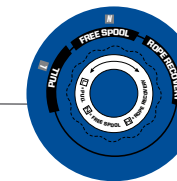

INTEGRATED WIRING INCLUDED

SEALED PERMANENT MAGNET MOTOR

CUT STEEL GEARS & SEALED DRIVETRAIN

AUTO STOP TECHNOLOGY

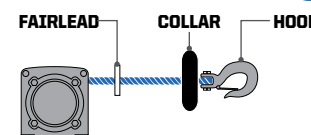

Winch stops when fairlead detects collar
Auto Stop Technology stops winch at end of pull to prevent driveline stress and plow overlifting

PREMIUM SYNTHETIC ROPE

- Lightweight & Easy to Handle
- Superior Flexibility
- Greater Strength than Steel Cable
- 50ft Long

HOOK WITH STRAP



WIRELESS REMOTE

50 Ft. range wireless remote control with unique code for interference-free operation

HID HEAVY DUTY SERIES

PULLING POWER FOR EVERYDAY USE & PERFORMANCE

INTEGRATED WIRING INCLUDED

SEALED PERMANENT MAGNET MOTOR

INTEGRATED WIRED REMOTE

50 FT STEEL CABLE

HOOK WITH STRAP



CUT STEEL GEARS & SEALED DRIVETRAIN

STEEL ROLLER FAIRLEAD

THERE'S A REASON THESE ARE THE BEST WINCHES ON THE MARKET.

Polaris® winches are fully sealed to keep out water, dust and other debris. Tested to ensure the heavy duty, quality components are strong enough to work when you need it the most.



TESTED 1,200+ PULLS AT MAX LOAD, IT WORKS WHEN YOU NEED IT TO



SEALED MOTOR & HEAVY DUTY GEARS OPERATE FULLY SUBMERGED UNDERWATER



BUILT TO WITHSTAND -20° F TEMPERATURES



MILITARY TESTED & APPROVED

PRO PRO HEAVY DUTY SERIES

PREMIUM FEATURES FOR TOP-OF-THE-LINE POWER



INDUSTRY-CLASS NEW TECHNOLOGY

RAPID ROPE RECOVERY 5x FASTER

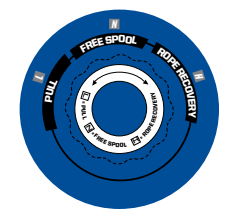

- RAPID ROPE RECOVERY**
1. Set Winch Dial to FREE SPOOL (N) to attach Winch Hook
 2. Set Winch Dial to PULL (L) for Winch Mode
 3. Set Winch Dial to ROPE RECOVERY (H) for 5x Faster Rope Recovery

PREASSEMBLED

Winch ready to install out of the box. Attached to mount and pre-wired.



WIRELESS REMOTE

50 Ft. range wireless remote control with unique code for interference-free operation



PREMIUM SYNTHETIC ROPE

- Lightweight & Easy to Handle
- Superior Flexibility
- Greater Strength than Steel Cable
- 50ft Long

AUTO STOP TECHNOLOGY

Auto Stop Technology stops winch at end of pull to prevent driveline stress and plow overlifting

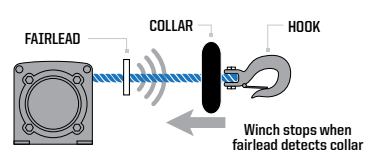

HID HEAVY DUTY SERIES

PULLING POWER FOR EVERYDAY USE & PERFORMANCE



- Cut steel gears for improved durability
- Steel spool can handle extreme loads
- 40% quieter - near-silent free spooling

- Sealed motor and drivetrain
- High-powered contactor
- Integrated wiring and mount plates ensure perfect fit

UPGRADE YOUR POLARIS® HD WINCH WITH THESE ACCESSORIES

POLARIS® WIRELESS WINCH REMOTE

» 2879316 • \$179⁹⁹
ALL SPORTSMAN® AND POLARIS ACE® MODELS

POWER CONTROLLER

- Allows the rider to control plow angle and blade height from inside the cab

» 2880836 • \$134⁹⁹
ACE® 570 '15-19, ACE® 500 '17-19

POLARIS® AUTO-STOP TECHNOLOGY WINCH UPGRADE KIT

- Requires use of synthetic cable rope (not included)

» 2881693 • \$134⁹⁹
ALL SPORTSMAN® AND POLARIS ACE® MODELS

REPLACEMENT STEEL CABLE

- 50' x 3/16"

» 2879919 • \$36⁹⁹
2500 LB WINCHES

SYNTHETIC WINCH ROPE

- Includes pre-woven loop

» 2878888 • \$104⁹⁹
2500 LB & 3500 LB WINCHES

WHY UPGRADE TO SYNTHETIC?

- Easier to work with - flexible and smooth texture
- More durable for plow usage
- Doesn't kink or bind like steel cable
- Lighter weight - even floats on water

NEW RECOVERY STRAP

- 5cm x 30' (8165 kg)
- 18,000 Lb. Breaking Strength / 9,000 Lb. Max. Vehicle Weight
- Comes with carry bag

» 2884033 • \$74⁹⁹

POLARIS.COM/WINCHES



		PRO PRO HEAVY DUTY SERIES	HID HEAVY DUTY SERIES	
MODEL		3,500 LB. WINCH SERIES	3,500 LB. WINCH SERIES with Synthetic Rope	2,500 LB. WINCH SERIES
POLARIS® SPORTSMAN®	450 H.O. '16-19	2882242 \$699 ⁹⁹	TOP SELLER 2880434 \$609 ⁹⁹	TOP SELLER 2880432 \$509 ⁹⁹
	570 '14-19			
	570 SP '15-19			
	570 X2 '15-19			
	TOURING 570 '14-19			
570 X2 SP '16-19	2882241 \$699 ⁹⁹	TOP SELLER 2880435 \$609 ⁹⁹	2880433 \$509 ⁹⁹	
570 6X6 '17-19				
XP 1000 / 850 SP / 850 '15-19	2882243 \$699 ⁹⁹	TOP SELLER 2882106 \$609 ⁹⁹	2882105 \$509 ⁹⁹	
TOURING XP 1000/850 '15-19				
XP 1000 / 850 HIGHLIFTER EDITION '16-19				
SCRAMBLER XP® 1000/850 '14-19**				
**MY14-15 REQUIRE CABLE (2879919)				
POLARIS ACE®	570 SP '15-17	2882243 \$699 ⁹⁹	TOP SELLER 2882106 \$609 ⁹⁹	2882105 \$509 ⁹⁹
	900 SP '16			
	500 '17-19			
	570 '16-19			
900 XC '17-19				

ALL WINCHES COME PRE-ASSEMBLED. NO ADDITIONAL COMPONENTS REQUIRED.

ACCESSORIES

WINCHES

570-450

XP 1000-850

POLARIS ACE®

AUDIO & ESSENTIALS

WHEELS & TIRES TRACKS

PLOW

LIGHTING

HUNT & COOLERS

TRAIL



View this Sportsman® & make it your own
[POLARIS.COM/570ride](https://Polaris.com/570ride)

SPORTSMAN® 570 SP
Magnetic Gray Metallic

WORK



View this Sportsman® & make it your own
[POLARIS.COM/570work](https://Polaris.com/570work)

SPORTSMAN® 570 EPS Utility Edition
Ghost Gray

570 • 450 SPORTSMAN®

MAKE IT YOURS

WORK HARD AND GET IT DONE with Polaris Engineered™ Accessories for your Sportsman®. Start with the ultimate in ATV performance and comfort, then add in lighting, wheels, tires, a winch, Glacier® plows and more. Find everything you need to outfit your trusted partner for the task at hand.

HUNT



View this Sportsman® & make it your own
[POLARIS.COM/570hunt](https://Polaris.com/570hunt)

SPORTSMAN® 570 SP
Polaris® Pursuit® Camo

PLOW



Check out all your plow options at
[POLARIS.COM/atvplows](https://Polaris.com/atvplows)

SPORTSMAN® 570 SP
Magnetic Gray Metallic

BUILD YOUR SPORTSMAN®

WINCHES

- Polaris® PRO HD 3,500 Lb. Winch 2882242
- Polaris® HD 3,500 Lb. Winch 2880434
- Polaris® HD 2,500 Lb. Winch 2880432

PROTECTION

- Front Brushguard 2879714
- Rear Brushguard 2879715
- Ultimate Series - Farm & Ranch Front Guard 2882301

RACKS

- Ultimate Series - Front Rack Extender 4" 2879716
- Ultimate Series - Rear Rack Extender 4" 2879717
- Tough Rack - Front 2882321
- Tough Rack - Rear 2882322
- Yukon Adventure Rack 2882084

COMFORT

- Throttle/Thumb Warmer 2877364
- Hand Warmers 2877363
- Handguards - Indy Red 2876845
- Handguards - Black 2876846
- Handguards - White 2876883
- Handguard Mount 2879380
- Handlebar Mounted Mirrors 2877222
- Lock & Ride® Sportsman® Backrest 2879887
- Waterproof Bluetooth® Audio 2880458

STORAGE

- Lock & Ride® Ultimate Series Rear Cargo Box 2882882
- Semi-rigid Touring Cargo Bag 2877220

WINDSHIELDS

- Sportsman® Windshield Tall 2880539-409
- Sportsman® Windshield Mid - Black 2880540-070
- Sportsman® Windshield Mid - Smoke 2880540-412
- Sportsman® Windshield Low - Black 2880541-070

DO MORE

- Rigid® & Pro Armor® Lighting P. 46
- Plows P. 44
- Hunt P. 48
- Wheels & Tires P. 38

SPORTSMAN[®] 570 • 450

View this Sportsman[®] & make it your own
POLARIS.COM/570ride

SPORTSMAN 570 SP
Magnetic Gray Metallic



View this Sportsman[®] & make it your own
POLARIS.COM/450sage

SPORTSMAN 450 H.O.
Sage Green

WINCHES

POLARIS[®] PRO HD 3,500 LB. WINCH TOP SELLER

» 2882242 • \$699⁹⁹

TOURING 570 SP '15-18, TOURING 570 '14-19, 6X6 570 '17-19,
570 X2 '15-19, 570 SP '15-19, 570 '14-19, 450 H.O. '16-19



INDUSTRY 1ST TECHNOLOGY

RAPID ROPE RECOVERY



LEARN MORE ON P. 10

A POLARIS[®] HD 3,500 LB. WINCH TOP SELLER

» 2880434 • \$609⁹⁹

TOURING 570 SP '15-18, TOURING 570 '14-19, 6X6 570 '17-19,
570 X2 '15-19, 570 SP '15-19, 570 '14-19, 450 H.O. '16-19



POLARIS[®] HD 2,500 LB. WINCH TOP SELLER

» 2880432 • \$509⁹⁹

TOURING 570 SP '15-18, TOURING 570 '14-19, 6X6 570 '17-19,
570 X2 '15-19, 570 SP '15-19, 570 '14-19, 450 H.O. '16-19



NEED A PLOW? SEE PAGE 44

BRUSHGUARDS

SPORTSMAN[®] 570 / 450 H.O. BRUSHGUARD TOP SELLER

- Durable black powdercoating for long-lasting, scratch-resistant finish
- Integrated mounting location for easy installation and accessory lighting



B FRONT BRUSHGUARD

» 2879714 • \$299⁹⁹ TOP SELLER

TOURING 570 SP '15-18, TOURING 570
'14-19, 6X6 570 '17-19, 570 X2 '15-19,
570 SP '15-19, 570 '14-19, 450 H.O. '16-19

REAR BRUSHGUARD

» 2879715 • \$229⁹⁹ TOP SELLER

TOURING 570 SP '15-18,
TOURING 570 '14-19,



C ULTIMATE SERIES – FARM & RANCH FRONT BRUSHGUARD

- Includes front receiver for additional functionality

» 2882301 • \$409⁹⁹

TOURING 570 '14-19, 6X6 570 '17-19,
570 X2 '15-19, 570 SP '19, 570 '14-19,
450 H.O. '19
DOES NOT FIT 570 SP MODELS

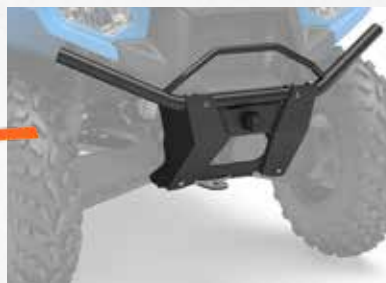

RACKS

ULTIMATE SERIES RACK EXTENDER 4" TOP SELLER

FRONT

» 2879716 • \$134⁹⁹

TOURING 570 SP '15-18, TOURING 570 '14-19, 6X6 570 '17-19, 570 X2 '15-19,
570 SP '15-19, 570 '14-19, 450 H.O. '16-19



REAR D

» 2879717 • \$134⁹⁹

570 SP '15-19, 570 '14-19, 450 H.O. '16-19

SPORTSMAN[®] 570/450 H.O. TOUGH RACK

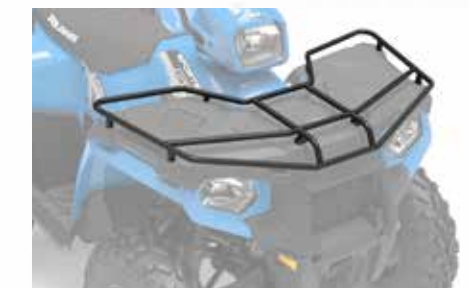

FRONT E

» 2882321 • \$179⁹⁹

TOURING 570 '14-19, 6X6 570 '17-19,
570 X2 '15-19, 570 SP '15-19,
570 '14-19, 450 H.O. '16-19



REAR F

» 2882322 • \$269⁹⁹

570 SP '15-19, 570 '14-19, 450
H.O. '16-19

LOCK & RIDE

YUKON ADVENTURE RACK

- Adds increased storage volume by allowing you to increase storage height securely

» 2882084 • \$409⁹⁹

6X6 570 '17-19



SPORTSMAN® 570 • 450

View this Sportsman® & make it your own
POLARIS.COM/450red

SPORTSMAN® 450 H.O. EPS
Indy Red



View this Sportsman® & make it your own
POLARIS.COM/570work

SPORTSMAN® 570 EPS Utility Edition
Ghost Gray

COMFORT



HAND WARMERS TOP SELLER

» 2877363 • \$79⁹⁹
ALL SPORTSMAN® MODELS



THROTTLE/THUMB WARMER

» 2877364 • \$64⁹⁹
ALL SPORTSMAN® MODELS

WATERPROOF BLUETOOTH® AUDIO

- Kit includes four mounting configurations
- Mounts easily to the handlebars or roll cage or fits in your dashboard storage area
- IPX4 -rated for water and dust resistance
- Internal LiPo rechargeable battery provides 12 hours of music between charges

» 2880458 • \$339⁹⁹

ALL SPORTSMAN® & POLARIS ACE® MODELS EXCEPT YOUTH



HANDGUARDS

COLORS

■ BLACK	2876846 • \$43 ⁹⁹
□ BRIGHT WHITE	2876883 • \$43 ⁹⁹
■ INDY RED	2876845 • \$43 ⁹⁹

- Handguard Mount (2879380) is required when installing Polaris Handguards
- Does not fit with windshield fairing or handlebar-mounted mirrors

» 2879380 • MOUNT • \$43⁹⁹

ALL SPORTSMAN® MODELS EXCEPT YOUTH



STORAGE



HANDLEBAR-MOUNTED MIRRORS TOP SELLER

- For added safety on or off the trail
- Sold as a pair
- Does not fit with windshield fairing or handguards

» 2877222 • \$54⁹⁹

ALL SPORTSMAN® MODELS EXCEPT YOUTH

LOCK & RIDE

SPORTSMAN® BACKREST

» 2879887 • \$269⁹⁹
570 SP '15-19, 570 '14-19, 450 H.O. '16-19
Does not fit with K-CARGO BOX, REAR, LOCK&RIDE® (2882882)



LOCK & RIDE

SPORTSMAN® ULTIMATE SERIES REAR CARGO BOX

- Increase your ATV storage with an extra 25 gallons of capacity
- Store two full-size helmets.

» 2882882 • \$409⁹⁹

XP 1000 '17-19, 850/850 SP '17-19, 570 SP '15-19, 570 '14-19, 450 H.O. '16-19
Cargo Box will not fit when Utility Rack is installed.



SEMI-RIGID TOURING CARGO BAG

- Large-capacity, heavy-duty vinyl bag
- Three zippered openings, removable dividers
- Attaches to rack with Velcro® straps

» 2877220 • \$209⁹⁹

TOURING 570 '14-19

SPORTSMAN® 570 · 450

View this Sportsman® & make it your own
[POLARIS.COM/570tour](https://www.polaris.com/570tour)

SPORTSMAN® Touring 570 EPS
Velocity Blue



View this Sportsman® & make it your own
[POLARIS.COM](https://www.polaris.com)

SPORTSMAN® 6x6 Big Boss 570 EPS
Sage Green

WINDSHIELDS



Tall 19.25" (48.9 cm) Clear

Mid 15.5" (39.4 cm) Black

Mid 15.5" (39.4 cm) Smoke

Low 9.5" (24.1 cm) Black

LOCK & RIDE® SPORTSMAN® WINDSHIELDS ^A

- Windshield installs on the ATV in seconds without tools with its Lock & Ride® technology. It can also be removed in seconds without tools.
- Lock & Ride® mounts allow a rider to adjust the height and angle of the windshield.
- Poly windshields are flexible, impact-resistant, and provide long-term value over the life of your machine.
- Three heights available for whatever coverage you prefer
- Does not work with handguards

TOP SELLER

SIZE	COLOR	PART #	PRICE
TALL 19.25" (48.9 CM)	CLEAR	2880539-409	\$209 ⁹⁹
MID 15.5" (39.4 CM)	BLACK	2880540-070	\$219 ⁹⁹
MID 15.5" (39.4 CM)	SMOKE	2880540-412	\$189 ⁹⁹
LOW 9.5" (24.1 CM)	BLACK	2880541-070	\$169 ⁹⁹

TOURING 570 '18-19, 570 X2 '18-19, 570 SP '15-19, 570 '18-19, 450 H.O. '18-19

DO MORE

LIGHTING SEE P. 46



HUNT SEE P. 48



PLOWS SEE P. 44



WHEELS & TIRES SEE P. 38



TRAIL



View this Sportsman® & make it your own
[POLARIS.COM/850ride](https://www.polaris.com/850ride)

SPORTSMAN® 850 SP
 White Lightning

WORK



View this Sportsman® & make it your own
[POLARIS.COM/850work](https://www.polaris.com/850work)

SPORTSMAN® 850
 Titanium Gray

XP® 1000 • 850 SPORTSMAN®

MAKE IT YOURS

WORK HARD AND GET IT DONE with Polaris Engineered™ Accessories for your Sportsman®. Start with the ultimate in ATV performance and comfort, then add in lighting, wheels, tires, a winch, Glacier® plows and more. Find everything you need to outfit your trusted partner for the task at hand.

HUNT



View this Sportsman® & make it your own
[POLARIS.COM/1000hunt](https://www.polaris.com/1000hunt)

SPORTSMAN XP® 1000
 Polaris® Pursuit® Camo

PLOW



View this Sportsman® & make it your own
[POLARIS.COM/1000plow](https://www.polaris.com/1000plow)

SPORTSMAN XP® 1000
 Radar Blue

BUILD YOUR SPORTSMAN® WINCHES

- Polaris® PRO HD 3,500 Lb. Winch 2882241
- Polaris® HD 3,500 Lb. Winch 2880435
- Polaris® HD 2,500 Lb. Winch 2880433

RACKS

- Ultimate Series - Front Rack Extender 4" 2882022
- Ultimate Series - Rear Rack Extender 4" 2882023
- Ultimate Series - Front Rack Extender 7" 2882024
- Ultimate Series - Rear Rack Extender 7" 2882025
- Sportsman Touring XP® - Front Rack Extender 2879890
- Ultimate Series - Steel Rack - Front 2883257
- Ultimate Series - Steel Rack - Rear 2883258
- Ultimate Series - Movable Tie-Down Points 2882270

PROTECTION

- Ultimate Series - Front Bumper 2882020
- Ultimate Series - Rear Bumper 2882583
- Ultimate Series - Body Armor 2882090
- Sportsman Touring XP® Brushguard - Front 2878709
- Sportsman Touring XP® Brushguard - Rear 2878324

STORAGE

- Lock & Ride® Ultimate Series Rear Cargo Box 2882882
- Ultimate Series - ReadyPack 2882271
- Ultimate Series - Rear Cargo Hold Bag 2882303
- Front Cargo Box 2877951
- Rear Storage Boxes 2878000

WINDSHIELDS

- Ultimate Series Windshield Tall View 2882152
- Ultimate Series Windshield Mid View 2882151
- Ultimate Series Windshield Low View 2882150
- Ultimate Series Windshield Tall View Hard Coat 2881161
- Ultimate Series Windshield Fairing 2882512
- Ultimate Series Windshield Fairing Bag 2882454
- Sportsman® Windshield Tall 2880539-409
- Sportsman® Windshield Mid - Black 2880540-070
- Sportsman® Windshield Mid - Smoke 2880540-412
- Sportsman® Windshield Low - Black 2880541-070

COMFORT

- Handlebar-Mounted Mirrors 2877222
- Hand Warmers 2877363
- Throttle/Thumb Warmer 2877364
- Waterproof Bluetooth® Audio 2880458
- Handguards - Indy Red 2876845
- Handguards - Black 2876846
- Handguards - White 2876883
- Handguard Mount 2879380

SPORTSMAN[®] XP 1000 • 850

View this Sportsman[®] & make it your own
POLARIS.COM/1000work

SPORTSMAN XP[®] 1000
Radar Blue



View this Sportsman[®] & make it your own
POLARIS.COM/850ride

SPORTSMAN[®] 850 SP
White Lightning

WINCHES

POLARIS[®] PRO HD 3,500 LB. WINCH TOP SELLER

» 2882241 • \$699⁹⁹

XP 1000/850 HIGH LIFTER '16-19, XP 1000 '15-19,
TOURING XP 1000 '15-19, TOURING 850 SP '15-19,
SCRAMBLER XP[®] 850 '14-19, SCRAMBLER XP[®] 1000 '14-18,
850/850 SP '12-19



INDUSTRY 1ST TECHNOLOGY

RAPID ROPE RECOVERY **5X**
FASTER

LEARN MORE ON P. 10

A POLARIS[®] HD 3,500 LB. WINCH TOP SELLER

» 2880435 • \$609⁹⁹

XP 1000/850 HIGH LIFTER '16-19, XP 1000 '15-19, TOURING XP
1000 '15-19, TOURING 850 SP '15-19, SCRAMBLER XP[®] 850 '14-19,
SCRAMBLER XP[®] 1000 '14-18, 850/850 SP '12-19



POLARIS[®] HD 2,500 LB. WINCH TOP SELLER

» 2880433 • \$509⁹⁹

XP 1000/850 HIGH LIFTER '16-19, XP 1000 '15-19, TOURING XP
1000 '15-19, TOURING 850 SP '15-19, SCRAMBLER XP[®] 850 '14-19,
SCRAMBLER XP[®] 1000 '14-18, 850/850 SP '12-19



NEED A PLOW, SEE PAGE 44

POLARIS.COM/ShopSPORTSMAN

RACKS

ULTIMATE SERIES RACK EXTENDER 4"

FRONT

» 2882022 • \$134⁹⁹

XP 1000 '17-19, 850/850 SP '17-19



REAR **B**

» 2882023 • \$134⁹⁹

XP 1000 '17-19, 850/850 SP '17-19

Fits with Rear Cargo Box (2882882)



ULTIMATE SERIES RACK EXTENDER 7"

C FRONT

» 2882024 • \$209⁹⁹

XP 1000 '17-19, 850/850 SP '17-19

REAR

» 2882025 • \$209⁹⁹

XP 1000 '17-19, 850/850 SP '17-19

Does not fit with (2882882)



SPORTSMAN XP[®] TOURING FRONT RACK EXTENDER

» 2879890 • \$134⁹⁹

TOURING XP 1000 '15-19, TOURING 850
SP '15-19

BRUSHGUARDS

SPORTSMAN[®] STEEL RACK

FRONT

» 2883257 • \$209⁹⁹

XP 1000 '17-19,
850/850 SP '17-19



REAR

» 2883258 • \$269⁹⁹

XP 1000 '17-19,
850/850 SP '17-19



D MOVEABLE TIE-DOWN POINTS

» 2882270 • \$74⁹⁹
(FRONT & REAR - SOLD IN PAIRS)

XP 1000 '17-19, 850/850 SP '17-19

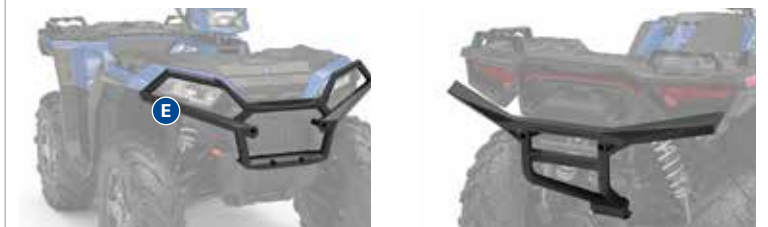

SPORTSMAN[®] ULTIMATE SERIES BUMPER TOP SELLER

• Quick installation to the integrated mounting tubes on the vehicle using wedge-style expansion anchor mounts

• Attach the Body Armor to the front bumper to provide the ultimate protection for the front fenders

» 2882020 • FRONT • \$339⁹⁹

XP 1000 '17-19, 850/850 SP '17-19

» 2882583 • REAR • \$269⁹⁹

XP 1000 '17-19, 850/850 SP '17-19



SPORTSMAN[®] ULTIMATE SERIES -BODY ARMOR

• Securely mounts to Ultimate Series Sportsman XP[®] Front Bumper (2882020)

• Comes as pair

» 2882090 • \$409⁹⁹

XP 1000 '17-19, 850/850 SP '17-19



SPORTSMAN TOURING XP[®] BRUSHGUARD

• Adds heavy-duty protection and a custom look

» 2878709 • \$299⁹⁹

TOURING XP 1000 '15-19, TOURING 850 SP '15-19

» 2878324 • REAR • \$209⁹⁹

TOURING XP 1000 '15-19, TOURING 850 SP '15-19

SPORTSMAN[®] XP 1000 • 850



View this Sportsman[®] & make it your own
[POLARIS.COM/850tour](https://www.polaris.com/850tour)

SPORTSMAN[®] TOURING 850 SP
Silver Pearl

View this Sportsman[®] & make it your own
[POLARIS.COM/1000WORK](https://www.polaris.com/1000work)

SPORTSMAN XP[®] 1000
Radar Blue

STORAGE



LOCK & RIDE[™] ULTIMATE SERIES REAR CARGO BOX TOP SELLER

- Increase your ATV storage with an extra 25 gallons of capacity
- Store two full-size helmets.

» 2882882 • \$409⁹⁹

XP 1000 '17-19, 850/850 SP '17-19, 570 SP '15-19, 570 '14-19, 450 H.O. '16-19

Does not fit with utility rack installed



ULTIMATE SERIES - READYPACK

- Keep your trail essentials at the ready with this easy-to-access, weather-resistant storage compartment

» 2882271 • \$89⁹⁹

XP 1000 '17-19, 850/850 SP '17-19



ULTIMATE SERIES REAR CARGO HOLD BAG

- Upgrade your stock rear storage component with this removable, divided storage bag

» 2882303 • \$83⁹⁹

XP 1000 '17-19, 850/850 SP '17-19



LOCK & RIDE[™] FRONT CARGO BOX A

» 2877951 • \$229⁹⁹

TOURING XP 1000 '15-19, TOURING 850 SP '15-19

The Front Rack Extender cannot be installed at the same time as the storage box



LOCK & RIDE[™] REAR STORAGE BOXES B

» 2878000 • \$259⁹⁹

TOURING XP 1000 '15-19, TOURING 850 SP '15-19

Slight interference with Sportsman[®] Touring 550/850 '11-14 passenger handles

WINDSHIELDS

SPORTSMAN[®] ULTIMATE SERIES WINDSHIELDS

Fairing required to add your preferred windshield or storage bag.

WINDSHIELD FAIRING

- Customizable system based on your style and protection needs
- Run just the fairing or add any of the windshields listed to the right
- Does not work with handguards or handlebar mounted mirror

» 2882512 • \$209⁹⁹

XP 1000 '17-19, 850/850 SP '17-19

WINDSHIELD FAIRING BAG

» 2882454 • \$55⁹⁹

XP 1000 '17-19, 850/850 SP '17-19



TALL VIEW

» 2882152 • \$134⁹⁹

XP 1000 '17-19, 850/850 SP '17-19

TALL VIEW HARD COAT

» 2881161 • \$269⁹⁹

XP 1000 '17-19, 850/850 SP '17-19

MID VIEW

» 2882151 • \$124⁹⁹

XP 1000 '17-19, 850/850 SP '17-19

LOW VIEW

» 2882150 • \$114⁹⁹

XP 1000 '17-19, 850/850 SP '17-19



EASY TO CHANGE WINDSHIELDS WITH 6-DART INSTALL

Our fairing system allows for changing out the windshield quickly and easily. Simply remove the six dart-type fasteners and swap out the windshield.

Mid 15.5" (39.4 cm) Black

Mid 15.5" (39.4 cm) Smoke

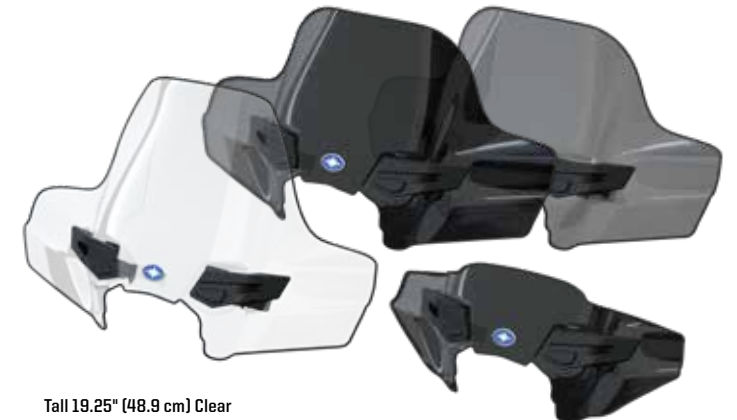

Tall 19.25" (48.9 cm) Clear

Low 9.5" (24.1 cm) Black

LOCK & RIDE[™] SPORTSMAN[®] WINDSHIELDS C

- Windshield installs on the ATV in seconds without tools with its Lock & Ride[™] technology. It can also be removed in seconds without tools.
- Lock & Ride[™] mounts allow a rider to adjust the height and angle of the windshield.
- Poly windshields are flexible, impact-resistant, and provide long-term value over the life of your machine.
- Three heights available for whatever coverage you prefer
- Does not work with handguards

TOP SELLER

SIZE	COLOR	PART #	PRICE
TALL 19.25" (48.9 CM)	CLEAR	2880539-409	\$209 ⁹⁹
MID 15.5" (39.4 CM)	BLACK	2880540-070	\$219 ⁹⁹
MID 15.5" (39.4 CM)	SMOKE	2880540-412	\$189 ⁹⁹
LOW 9.5" (24.1 CM)	BLACK	2880541-070	\$169 ⁹⁹

XP 1000 '15-16, TOURING XP 1000 '15-19, TOURING 850 SP '15-19, TOURING 570 SP '15-17, 850/850 SP '09-16, 570 SP '15-19, 570 '18-19, 570 6X6 '17-19, 450 H.O. '18-19

SPORTSMAN[®] XP 1000 • 850

View this Sportsman[®] & make it your own
POLARIS.COM/1000tour
SPORTSMAN[®] TOURING XP 1000
Rusty Maroon



SCRAMBLER[®] XP 1000 • 850

SCRAMBLER[®] 850
Ghost Gray



COMFORT



HANDGUARDS

COLORS

- BLACK 2876846 • \$43⁹⁹
- BRIGHT WHITE 2876883 • \$43⁹⁹
- INDY RED 2876845 • \$43⁹⁹

• Handguard Mount (2879380) is required when installing Polaris Handguards

• Does not fit with windshield fairing or handlebar-mounted mirrors

» 2879380 • MOUNT • \$43⁹⁹

ALL SPORTSMAN[®] MODELS EXCEPT YOUTH

WATERPROOF BLUETOOTH[®] AUDIO

- Kit includes four mounting configurations
- Mounts easily to the handlebars or roll cage or fits in your dashboard storage area
- IPX4-rated for water and dust resistance
- Internal LiPo rechargeable battery provides 12 hours of music between charges

» 2880458 • \$339⁹⁹

ALL SPORTSMAN[®] & POLARIS ACE[®] MODELS EXCEPT YOUTH MODELS



A HANDLEBAR-MOUNTED MIRRORS TOP SELLER

- For added safety on or off the trail
- Does not work with windshield fairing

» 2877222 • \$54⁹⁹

ALL SPORTSMAN[®] MODELS EXCEPT YOUTH

HAND WARMERS TOP SELLER

» 2877363 • \$79⁹⁹

ALL SPORTSMAN[®] MODELS



THROTTLE/THUMB WARMER

» 2877364 • \$64⁹⁹

ALL SPORTSMAN[®] MODELS

DO MORE

LIGHTING

SEE P. 46



PLOWS

SEE P. 44



HUNT

SEE P. 48



WHEELS & TIRES

SEE P. 38



WINCH



POLARIS[®] TOP SELLER
PRO HD 3,500 LB. WINCH NEW

» 2882241 • \$699⁹⁹

XP 1000/850 HIGH LIFTER '16-19, XP 1000 '15-19, TOURING XP 1000 '15-19, TOURING 850 SP '15-19, SCRAMBLER XP[®] 850 '14-19, SCRAMBLER XP[®] 1000 '14-18, 850/850 SP '12-19



A POLARIS[®] TOP SELLER
HD 3,500 LB. WINCH

» 2880435 • \$609⁹⁹

XP 1000/850 HIGH LIFTER '16-19, XP 1000 '15-19, TOURING XP 1000 '15-19, TOURING 850 SP '15-19, SCRAMBLER XP[®] 850 '14-19, SCRAMBLER XP[®] 1000 '14-18, 850/850 SP '12-19



POLARIS[®] TOP SELLER
HD 2,500 LB. WINCH

» 2880433 • \$509⁹⁹

XP 1000/850 HIGH LIFTER '16-19, XP 1000 '15-19, TOURING XP 1000 '15-19, TOURING 850 SP '15-19, SCRAMBLER XP[®] 850 '14-19, SCRAMBLER XP[®] 1000 '14-18, 850/850 SP '12-19

RACKS



LARGE REAR RACK

» 2879139 • \$219⁹⁹

SCRAMBLER XP[®] 850 '14-19, SCRAMBLER XP[®] 1000 '14-18
Not compatible with Ogio[®] Scrambler[®] Bag (2879925)

STORAGE



B OGIO[®] SCRAMBLER[®] BAG

» 2879925 • \$229⁹⁹

SCRAMBLER XP[®] 850 '14-19, SCRAMBLER XP[®] 1000 '14-18

PROTECTION



FRONT BRUSHGUARD

» 2879136 • \$269⁹⁹

SCRAMBLER XP[®] 850 '14-19, SCRAMBLER XP[®] 1000 '14-18
Replaces existing lower bumper will not work together



REAR BASH GUARD

» 2879138 • \$189⁹⁹

SCRAMBLER XP[®] 850 '14-19, SCRAMBLER XP[®] 1000 '14-18



View the full Polaris ACE® lineup at
[POLARIS.COM/ace](https://www.polaris.com/ace)

POLARIS ACE 900 XC
Black Pearl

900 XC • 570 • 500 POLARIS ACE®

MAKE IT YOURS

WORK HARD AND GET IT DONE with Polaris Engineered™ Accessories for your Polaris ACE®. Start with the ultimate in Polaris ACE® performance and comfort, then add in lighting, wheels, tires, a winch, Glacier® plows and more. Find everything you need to outfit your trusted partner for the task at hand.

BUILD YOUR POLARIS ACE®

WINCHES

- Polaris® PRO HD 3,500 Lb. Winch 2882243
- Polaris® HD 3,500 Lb. Winch 2882106
- Polaris® HD 2,500 Lb. Winch 2882105

RACKS

- Bed Extender 2882886
- Front Rack Extender 2882885

PROTECTION

- XC Bumper - Front 2882258
- XC Bumper - Rear 2882259
- Extreme Brushguard - Front 2882504
- Extreme Brushguard - Rear 2882924
- Low Profile Rock Sliders 2881151
- Nerf Bars 2879700
- Skid Plate 2880543

COMFORT

- Flip-Down Windshield - Hard Coat - Poly 2882443
- Full Windshield - Poly 2879693
- Mid Windshield - Poly 2879694
- Rear Panel - Poly 2881774
- Canvas Cab 2880646
- Sport Doors 2881429
- Lower Door Extensions 2880272
- Sport Roof - Poly 2881147
- Canvas Roof 2879692
- Side Mirrors 2881517
- Rear View Mirror 2879712

STORAGE

- Lock & Ride® Rear Cargo Box 2881447

DO MORE

- Rigid® & Pro Armor® Lighting P. 46
- Plows P. 44
- Hunt P. 48
- Wheels & Tires P. 38



POLARIS ACE[®] 900 XC • 570 • 500



WINCHES

TOP SELLER
**POLARIS[®] PRO HD
3,500 LB. WINCH**

» 2882243 • **\$699**⁹⁹
POLARIS ACE[®] 900 XC '17-19,
POLARIS ACE[®] 570 '15-19,
POLARIS ACE[®] 500 '17-19



INDUSTRY 1ST TECHNOLOGY
RAPID ROPE RECOVERY **5X**
FASTER

LEARN MORE ON P. 10

A **TOP SELLER**
**POLARIS[®] HD
3,500 LB. WINCH**

» 2882106 • **\$609**⁹⁹
POLARIS ACE[®] 900 XC '17-19, POLARIS ACE[®] 570 '15-19,
POLARIS ACE[®] 500 '17-19



TOP SELLER
**POLARIS[®] HD
2,500 LB. WINCH**

» 2882105 • **\$509**⁹⁹
POLARIS ACE[®] 900 XC '17-19, POLARIS ACE[®] 570 '15-19,
POLARIS ACE[®] 500 '17-19



NEED A PLOW, SEE PAGE 44

RACKS



BED EXTENDER

- Creates up to 28 gallons of storage volume on your storage bed
 - Adds 4.5" of height to the rear perimeter of storage bed
 - Steel construction
- » 2882886 • **\$209**⁹⁹
POLARIS ACE[®] 900 XC '17-19, POLARIS ACE[®] 570 '15-19,
POLARIS ACE[®] 500 '17-19



FRONT RACK EXTENDER

- Increase front rack carrying capacity
 - 4"-tall support design around the front and side perimeter of the rack
 - Steel construction
 - Angular design enhances the look of your machine
 - Easily mounts with four bolts
- » 2882885 • **\$134**⁹⁹
POLARIS ACE[®] 900 XC '17-19, POLARIS ACE[®] 570 '15-19,
POLARIS ACE[®] 500 '17-19

PROTECTION

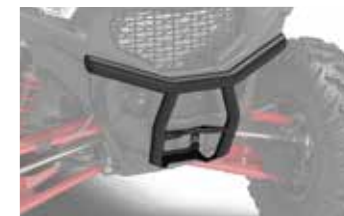

B XC BUMPER

- Contoured steel tube design fits perfectly and flows with the sculpted design cues of the Polaris ACE[®] 900 XC
- » FRONT • 2882258 • **\$189**⁹⁹
POLARIS ACE[®] 900 XC '17-19



XC BUMPER

- Contoured steel tube design fits perfectly and flows with the sculpted design cues of the Polaris ACE[®] 900 XC
- » REAR • 2882259 • **\$179**⁹⁹
POLARIS ACE[®] 900 XC '17-19

PROTECTION



TOP SELLER EXTREME BRUSHGUARD

- Strong 1.25" (3.2cm) diameter steel tube construction with a durable, scratch-resistant black powder-coated finish
- » FRONT • 2882504 • **\$309**⁹⁹
POLARIS ACE[®] 570 '15-19,
POLARIS ACE[®] 500 '17-19



EXTREME BRUSHGUARD

- Strong 1.25" (3.2cm) diameter steel tube construction with a durable, scratch-resistant black powder-coated finish
- » REAR • 2882924 • **\$209**⁹⁹
POLARIS ACE[®] 570 '15-19,
POLARIS ACE[®] 500 '17-19



LOW PROFILE ROCK SLIDERS

- Low-profile design hugs bodywork without compromising ground clearance
- » 2881151 • **\$209**⁹⁹
POLARIS ACE[®] 570 '15-19,
POLARIS ACE[®] 500 '17-19
Expanding Anchor Technology - minimal tools required



NERF BARS

- 5" kick-out protects the side of the vehicle, acting as a buffer between the vehicle and obstacles
- » 2879700 • **\$269**⁹⁹
POLARIS ACE[®] 570 '15-19,
POLARIS ACE[®] 500 '17-19

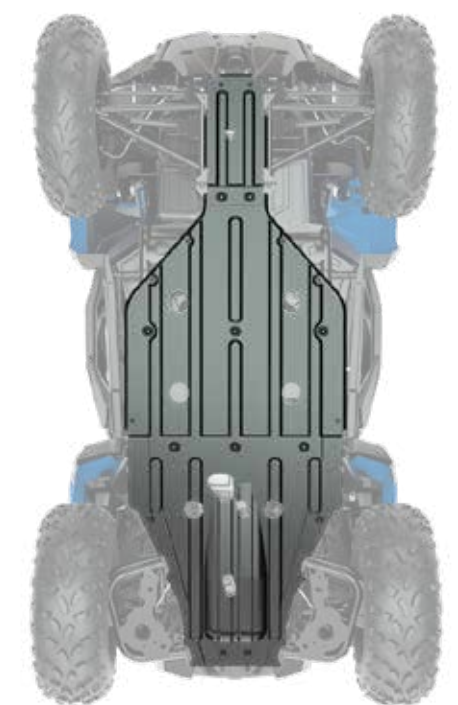

SKID PLATE

- Strong, durable, lightweight 3/8" HMW (high-molecular weight) polyethylene construction
- » 2880543 • **\$439**⁹⁹
POLARIS ACE[®] 570 '15-19, POLARIS ACE[®] 500 '17-19

POLARIS ACE[®] 900 XC • 570 • 500



COMFORT

A LOCK & RIDE FLIP-DOWN WINDSHIELD - HARD COAT POLY

- In its up position, experience full protection from wind, mud, rain, or whatever you encounter

» 2882443 • \$409⁹⁹
POLARIS ACE[®] 900 XC '17-19, POLARIS ACE[®] 570 '15-19, POLARIS ACE[®] 500 '17-19



LOCK & RIDE FULL WINDSHIELD - POLY

- Windshield is made of impact- and shatter-resistant 0.177" polycarbonate with hard coat on both sides

» 2879693 • \$379⁹⁹
POLARIS ACE[®] 900 XC '17-19, POLARIS ACE[®] 570 '15-19, POLARIS ACE[®] 500 '17-19



B LOCK & RIDE MID WINDSHIELD - POLY

- Provides protection while also allowing airflow to reach the rider
- Strong, durable, impact-resistant polycarbonate

» 2879694 • \$179⁹⁹
POLARIS ACE[®] 900 XC '17-19, POLARIS ACE[®] 570 '15-19, POLARIS ACE[®] 500 '17-19



LOCK & RIDE REAR PANEL - POLY

- Can be used with other accessories such as roof, cargo bags, etc.

» 2881774 • \$249⁹⁹
POLARIS ACE[®] 900 XC '17-19, POLARIS ACE[®] 570 '15-19, POLARIS ACE[®] 500 '17-19



C LOWER DOOR EXTENSIONS TOP SELLER

- Extensions install on Sport Doors (2881429, sold separately) and create a single, integrated door unit
- » 2880272 • \$409⁹⁹
POLARIS ACE[®] 900 XC '17-19, POLARIS ACE[®] 570 '15-19, POLARIS ACE[®] 500 '17-19

D SPORT DOORS

- Steel frame and strong plastic exterior
- » 2881429 • \$669⁹⁹
POLARIS ACE[®] 500 '17-18



CANVAS CAB

- Included are: canvas roof/rear panel and canvas doors
- Requires the use of accessory Full Poly Windshield (2879693; sold separately)
- Not compatible with Polaris ACE[®] Sport Doors (2879697)

» 2880646 • \$1,069⁹⁹
POLARIS ACE[®] 900 XC '17-19, POLARIS ACE[®] 570 '15-19, POLARIS ACE[®] 500 '17-19



E LOCK & RIDE SPORT ROOF - POLY

» 2881147 • \$269⁹⁹
POLARIS ACE[®] 900 XC '17-19, POLARIS ACE[®] 570 '15-19, POLARIS ACE[®] 500 '17-19

CANVAS ROOF

» 2879692 • \$179⁹⁹
POLARIS ACE[®] 900 XC '17-19, POLARIS ACE[®] 570 '15-19, POLARIS ACE[®] 500 '17-19

DO MORE...



LOCK & RIDE REAR CARGO BOX TOP SELLER

- Installs without tools using twin Lock & Ride[®] plungers, locks into vehicle's cargo space
- Handles make it easy to carry Cargo Box to and from vehicle
- D-rings on top of box serve as tie-down points for bungees, straps, cargo nets, etc.

» 2881447 • \$339⁹⁹
POLARIS ACE[®] '14-16, POLARIS ACE[®] 900 XC '17-19, POLARIS ACE[®] 900 SP '16, POLARIS ACE[®] 570 SP '16-17, POLARIS ACE[®] 570 '15-19, POLARIS ACE[®] 500 '17-19



F SIDE MIRRORS

» 2881517 • \$209⁹⁹
POLARIS ACE[®] 900 XC '17-19, POLARIS ACE[®] 570 '15-19, POLARIS ACE[®] 500 '17-19



REAR VIEW MIRROR

» 2879712 • \$89⁹⁹
POLARIS ACE[®] 900 XC '17-19, POLARIS ACE[®] 570 '15-19, POLARIS ACE[®] 500 '17-19

LIGHTING SEE P. 46



PLOWS SEE P. 36



HUNT SEE P. 48



WHEELS & TIRES SEE P. 38



POLARIS ACE® 150

**THE ONLY SINGLE SEAT
YOUTH ATV WITH A
FULL CAB FRAME**



A. POLY ROOF

» 2882263 • **\$179⁹⁹**
POLARIS ACE® 150 '17-19

B. HALF WINDSHIELD

» 2882264 • **\$134⁹⁹**
POLARIS ACE® 150 '17-19

C. FRONT & REAR BRUSHGUARD

» 2882472 • **\$134⁹⁹**
POLARIS ACE® 150 '17-19

TRAILERING AND RECOVERY STRAPS



NEW 2" X 30' RECOVERY STRAP

- Heavy duty webbing
- 18,000 Lb. Breaking Strength / 9,000 Lb. Max. Vehicle Weight
- Built in strap wrap - easy storage
- Loops sewn in to webbing
- 1 Strapbag

» 2884033 • **\$74⁹⁹**

NEW 2" X 20' 10,000 LB RATCHET STRAP

- Heavy duty webbing
- 10,000 Lb. Maximum Load / 3,300 Lb. Working Load
- Floating D-Rings
- Double J-Hooks

» 2884032 • **\$43⁹⁹**

NEW 1.5" X 15' 5,500 LB RATCHET STRAP

- Heavy duty webbing
- 5,500 Lb. Maximum Load / 1,833 Lb. Working Load
- 2 Pack

» 2884031 • **\$59⁹⁹**

SHOCKSTRAP

- » 2883295 • 1.5" X 7' (2 PACK) **\$94⁹⁹**
- » 2883296 • 1.5" X 15' (2 PACK) **\$109⁹⁹**

POLARIS® SPORTSMAN® & POLARIS ACE® AUDIO & ESSENTIAL ACCESSORIES



MTX® OVERHEAD AUDIO POD **POLARIS ACE®**

- Bluetooth® connectivity for wireless audio
- USB port for charging mobile devices in waterproof storage locker
- LCD display shows audio information; convenient LED lights shine toward rider
- Auxiliary connection through headphone jack
- Dual 6" speakers and tweeters that direct sound toward rider
- Installs in less than 15 minutes; includes all wiring
- Durable, sealed, hard plastic black housing
- Can be used with a roof and windshield; not compatible with Overhead Storage Bag

» 2879703 • **\$649⁹⁹**

ALL POLARIS ACE® MODELS



SOUND BAR 4 **POLARIS ACE®**

- Dual mid-range/mid-bass speaker and two dedicated tweeters
- Integrated, self-powered amplifier for easy installation
- Bluetooth® or wired audio input with variable output
- Large, easy-to-use external controls
- Aluminum, black finish housing with low profile, clamp-on mounts
- Includes mounts, audio bar, waterproof connections, and instructions

» 2881230 • **\$509⁹⁹**

ALL POLARIS ACE® MODELS

Requires Audio Harness (2882280)

» 2882280 • **\$99⁹⁹**



WATERPROOF BLUETOOTH® AUDIO **POLARIS ACE® SPORTSMAN®**

- Kit includes four mounting configurations
- Mounts easily to the handlebars or roll cage or fits in your dashboard storage area
- IPX4 -rated for water and dust resistance
- Internal LiPo rechargeable battery provides 12 hours of music between charges

» 2880458 • **\$339⁹⁹**

ALL SPORTSMAN® & POLARIS ACE® MODELS EXCEPT YOUTH



SPORTSMAN® BOOM SPRAYER - 15 GAL

» 2882266 • **\$539⁹⁹**

ALL SPORTSMAN® MODELS EXCEPT TOURING



RIDE & REPAIR ESSENTIALS KIT

- 12-volt DC portable air compressor
- Tire repair kit with 6 plugs
- Basic first-aid kit with bandages, scissors, safety pins, and more
- 12-volt jumper cables
- Duct tape - 300mm x 1 roll
- Zip ties - 150mm length
- Electrical tape
- Ratchet strap - 50mm
- Microfiber cloth
- Carry bag

» 2881207 • **\$134⁹⁹**

QUICKTAP BATTERY POSTS

- Easy-to-access terminal posts give you quick access to the battery power
- Ideal for charging your battery, powering a temporary accessory, or when you need to offer an unexpected jump-start
- Connection posts feature covers to protect terminals when not in use

» 2882110 • **\$74⁹⁹**

X2 570 '15-19, TOURING 570 '14-19, 570 SP '15-19, 570 '14-19, 570 6X6 '17-19

LICENSE PLATE KIT

- Includes numbers & letters

» 2873270 • **\$20⁹⁹**

ALL SPORTSMAN® MODELS



PRO ARMOR®

Each wheel and tire Pro Armor® designs for off-road vehicles performs perfectly in the intended environment for its intended use. Developed, tested, and produced in partnership so you can tackle the terrain ahead with Polaris®.



TIRES

8 OR 10-PLY RATED

- Pro Armor® builds the toughest tires
- Higher ply ratings mean added protection

INNOVATION

DUAL-DUROMETER LUGS (Crawler XG & Attack 2.0)

- Firm durometer rubber on base of lug for stability
- Soft durometer rubber on top of lug for sticky grip

DUAL COMPOUND TREAD (Dual-Threat)

- Firm durometer rubber on center of tread for long wear life
- Soft durometer rubber on shoulders of tread for superior grip



TRIPLE-BELTED SIDEWALLS

- Sidewalls are the most vulnerable puncture area of any off-road tire
- Pro Armor® makes tires with extra protection exactly where it's needed most - the sidewall

Sidewall puncture force vs. competition independently tested at Smithers Rapra (smithers.com). The results speak for themselves.

PRO ARMOR® ATTACK	157.4 kg
MAXXIS® BIGHORN 2.0	73.5 kg
MAXXIS® BIGHORN	68 kg

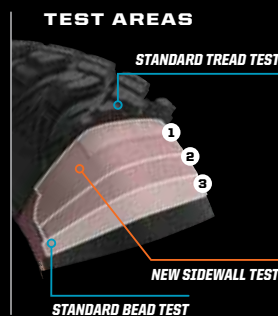

TORTURE-TESTED TOUGH SIDEWALLS

4,828+ km RATED

Pile on the kilometers with Pro Armor® tires. Every tire is designed and constructed with longevity in mind. With ratings of 4,828 km and beyond, you are assured long life and performance.

KNOW YOUR TIRES

DIMENSIONS
28" x 9" R14
TIRE HEIGHT / TIRE WIDTH / WHEEL DIAMETER

TREAD DEPTH
Deeper tread = more grip in all conditions

PADDLE DEPTH
Increases grip and performance in the sand

WEIGHT
A lighter tire makes for improved vehicle performance

SIDEWALL BELTS
Increase your resistance to sidewall punctures

PLY RATING
Indicates the puncture-resistance of a tire

LOAD RATING
Tires with higher load ratings can handle more weight

KNOW YOUR TERRAIN

- TRAIL**
 - Tread patterns optimized for extreme traction
 - Ideal for both hard pack and loose trail
- DUNES**
 - Paddles provide traction and durability in soft sand
 - Built to float on top of sand

- ROCK**
 - Flexible "grippy" tread
 - Aggressive side bite
- UTILITY**
 - Industry leading anti-puncture side walls
 - Purpose-built, long lasting tread patterns

- DESERT**
 - Provides traction and durability
 - Built to perform in hard sand, jagged rocks or any other extreme terrain
- SNOW**
 - Handles extreme cold
 - Holds shape and provides traction

- MUD**
 - Extra deep treads
 - Self-cleaning lugs

TRAIL



FRONT

REAR

PRO ARMOR® DUAL-THREAT

Engineered with dual-compound technology and radial construction to offer revolutionary off-road performance in all terrains. The lateral-grip compound on the outer edges of the tire has a softer durometer rubber for cornering performance and superior grip. The long-wearing compound in the middle of the tire has harder durometer rubber for increased traction during acceleration, straight line stability, and overall longer tread life.

- 14" 26" x 9" R14 • FRONT • 5416340 • \$219⁹⁹
- 14" 26" x 11" R14 • REAR • 5416341 • \$229⁹⁹

	TREAD DEPTH	WEIGHT	PLY RATING	SIDEWALL BELTS	LOAD RATING
FRONT	16mm	27 lbs	10	3	910 lbs
REAR	30 lbs				1,100 lbs



WHEEL SIZE

14"

UTILITY

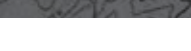

WHEEL SIZE

14" 12"



PRO ARMOR HARVESTER®

- All-around workhorse with tread life of 5,000 miles
- Tread pattern designed to withstand anything from the farmyard and to the pastures to the trail
- With 10-Ply, it can carry the load day in and day out

- 14" 27" x 10" R14 • FRONT/REAR • 5415965 • \$249⁹⁹
- 12" 26" x 8" R12 • FRONT • 5416396 • \$229⁹⁹
- 12" 26" x 10" R12 • REAR • 5415966 • \$249⁹⁹



PRO ARMOR PRESERVE™

- Turf-friendly for areas where low impact from tire tread is needed
- Exceptionally quiet-running tire
- Low impact tire

- 14" 27" x 10" R14 • FRONT/REAR • 5416348 • \$249⁹⁹
- 12" 26" x 10" R12 • REAR • 5415966 • \$249⁹⁹



PRO ARMOR XD-K

- 26" Aramid fiber-belted tire can tackle any terrain
- Unique full-face tread design
- Harder durometer lugs promotes for extended wear increasing tire life

- 12" 26" x 9" R12 • FRONT • 5415756 • \$249⁹⁹
- 12" 26" x 11" R12 • REAR • 5415757 • \$269⁹⁹



FRONT / REAR

PRO ARMOR ATTACK

- The best all-purpose tire for all-season traction in any terrain
- Unique full-face tread design
- Harder durometer lugs promote extended wear, increasing tire life

- 14" 26" x 9" R14 • FRONT • 5415613 • \$189⁹⁹
- 14" 26" x 11" R14 • REAR • 5415614 • \$209⁹⁹

	TREAD DEPTH	WEIGHT	PLY RATING	SIDEWALL BELTS	LOAD RATING
FRONT	23mm	28 lbs	8	3	910 lbs
REAR	32 lbs				1,320 lbs



WHEEL SIZE

14"

SNOW



FRONT / REAR

PRO ARMOR WHITEOUT

- Extra wide tires for flotation in snow
- Tread pattern designed for superior snow traction with limited digging

- 14" 27" x 14" R14 • FRONT/REAR • 5416032 • \$369⁹⁹

	TREAD DEPTH	WEIGHT	PLY RATING	SIDEWALL BELTS	LOAD RATING
FRONT	16mm	27 lbs	8	3	935 lbs
REAR					



WHEEL SIZE

14"

MUD



FRONT

REAR

PRO ARMOR DAGGER

- From the trails to the pits, this tire gets you through it all
- Deep, self-cleaning lug and wide tire design for exceptional mud pit performance
- Rounded profile and full lug pattern for on-trail comfort

- 14" 27" x 9" R14 • FRONT • 5415617 • \$279⁹⁹
- 14" 27" x 11" R14 • REAR • 5415618 • \$299⁹⁹

	TREAD DEPTH	WEIGHT	PLY RATING	SIDEWALL BELTS	LOAD RATING
FRONT	38mm	32 lbs	8	3	1,100 lbs
REAR	40 lbs				1,170 lbs



WHEEL SIZE

14"

WHEELS



A AMPLIFY

FRONT:	Weight: 5.9 kg	Offset: -9
	Load Rating: 408 kg	
REAR:	Weight: 6.4 kg	Offset: +4
	Load Rating: 590 kg	
ACCENT:	FRONT 14" x 7"	1522956-266 \$189 ⁹⁹
	REAR 14" x 8"	1522957-266 \$209 ⁹⁹
MATTE BLACK:	FRONT 14" x 7"	1522956-458 \$169 ⁹⁹
	REAR 14" x 8"	1522957-458 \$179 ⁹⁹

B BUCKLE

FRONT:	Weight: 5.8 kg	Offset: +4
	Load Rating: 408 kg	
REAR:	Weight: 6.1 kg	Offset: -9
	Load Rating: 590 kg	
ACCENT:	FRONT 14" x 7"	1522544-266 \$189 ⁹⁹
	REAR 14" x 8"	1522545-266 \$209 ⁹⁹
MATTE BLACK:	FRONT 14" x 7"	1522544-458 \$169 ⁹⁹
	REAR 14" x 8"	1522545-458 \$179 ⁹⁹

C COMBAT (BEADLOCK RINGS INCLUDED)

FRONT/REAR:	Weight: 7.3 kg	Offset: +38
	Load Rating: 726 kg	
ACCENT:	FRONT/REAR 14" x 7"	1523284 \$269 ⁹⁹
MATTE BLACK:	FRONT/REAR 14" x 7"	1523283 \$259 ⁹⁹

D REBLR (BEADLOCK RINGS SOLD SEPARATELY)

FRONT:	Weight: 5.9 kg	Offset: +4
	Load Rating: 408 kg	
REAR:	Weight: 6.6 kg	Offset: -9
	Load Rating: 590 kg	
ACCENT:	FRONT 14" x 7"	1522238-458 \$279 ⁹⁹
	REAR 14" x 8"	1522239-458 \$279 ⁹⁹

E SHACKLE

FRONT:	Weight: 5.9 kg	Offset: +4
	Load Rating: 408 kg	
REAR:	Weight: 6.4 kg	Offset: -9
	Load Rating: 590 kg	
ACCENT:	FRONT 14" x 7"	1522546-266 \$189 ⁹⁹
	REAR 14" x 8"	1522547-266 \$189 ⁹⁹
MATTE BLACK:	FRONT 14" x 7"	1522546-458 \$169 ⁹⁹
	REAR 14" x 8"	1522547-458 \$169 ⁹⁹

F SIX'R

FRONT:	Weight: 4.8 kg	Offset: +4
	Load Rating: 408 kg	
REAR:	Weight: 5.7 kg	Offset: -9
	Load Rating: 590 kg	
MATTE BLACK:	FRONT 14" x 7"	1521507-521 \$149 ⁹⁹
	REAR 14" x 8"	1521508-521 \$169 ⁹⁹
LUSTER:	FRONT 14" x 7"	1521507-410 \$189 ⁹⁹
	REAR 14" x 8"	1521508-410 \$199 ⁹⁹

G SPLIT

FRONT:	Weight: 4.3 kg	Offset: +4
	Load Rating: 408 kg	
REAR:	Weight: 4.9 kg	Offset: -9
	Load Rating: 590 kg	
MATTE BLACK:	FRONT 14" x 6"	1522542-458 \$169 ⁹⁹
	REAR 14" x 8"	1522543-458 \$179 ⁹⁹

H WHITEOUT

FRONT:	Weight: 6.6 kg	Offset: -35
	Load Rating: 363 kg	
REAR:	Weight: 6.6 kg	Offset: -35
	Load Rating: 363 kg	
MATTE BLACK:	FRONT/REAR 14" x 10"	1522958 \$229 ⁹⁹

2 WAYS TO PURCHASE INDIVIDUAL WHEELS & TIRES - OR - COMPLETE SETS AS LISTED

VISIT Polaris.com/ProArmorSPORTSMAN TO BUILD YOUR CUSTOM SET

Exclusively at Polaris® Authorized Dealers or Polaris.com/ProArmorSPORTSMAN

14" FORGED BEADLOCK RINGS



14" FORGED BEADLOCK RINGS Sold individually
Only used on REBLR

	PART #	
A	1522244-619	\$114 ⁹⁹
B	1522244-266	\$114 ⁹⁹
C	1522244-133	\$114 ⁹⁹
D	1522244-293	\$114 ⁹⁹
E	1522244-589	\$114 ⁹⁹
F	1523146-458	\$74 ⁹⁹

Matte Black - Replacement
Only used on Combat

WHEEL & TIRE SETS

14" WHEELS	TRAIL		MUD		UTILITY		SNOW	
	ATTACK 26"	DUAL-THREAT 26"	DAGGER 27"	PRESERVE 27"	HARVESTER 27"	WHITEOUT 27"		
AMPLIFY Accent	2882390 \$1,489 ⁹⁹	2883138 \$1,669 ⁹⁹	2882392 \$1,799 ⁹⁹	2883208 \$1,599 ⁹⁹	2882388 \$1,739 ⁹⁹			
AMPLIFY Matte Black	2882391 \$1,359 ⁹⁹	2883139 \$1,539 ⁹⁹	2882393 \$1,669 ⁹⁹	2883209 \$1,599 ⁹⁹	2882389 \$1,599 ⁹⁹			
BUCKLE Accent	2881335 \$1,599 ⁹⁹	2883140 \$1,699 ⁹⁹	2881337 \$1,999 ⁹⁹	2883203 \$1,739 ⁹⁹	2882383 \$1,739 ⁹⁹			
BUCKLE Matte Black	2881336 \$1,479 ⁹⁹	2883141 \$1,539 ⁹⁹	2881338 \$1,799 ⁹⁹	2883204 \$1,599 ⁹⁹	2882384 \$1,599 ⁹⁹			
COMBAT Accent *BEADLOCKS PRE-MOUNTED		2883217 \$2,059 ⁹⁹						
COMBAT Matte Black *BEADLOCKS PRE-MOUNTED		2883216 \$1,939 ⁹⁹						
REBLR Matte Black *BEADLOCKS SOLD SEPARATELY	2881381 \$1,669 ⁹⁹		2881383 \$1,999 ⁹⁹					
SHACKLE Accent	2881347 \$1,599 ⁹⁹	2883142 \$1,699 ⁹⁹	2881349 \$1,999 ⁹⁹	2883205 \$1,739 ⁹⁹	2882385 \$1,739 ⁹⁹			
SHACKLE Matte Black	2881348 \$1,479 ⁹⁹	2883143 \$1,539 ⁹⁹	2881350 \$1,799 ⁹⁹	2883206 \$1,599 ⁹⁹	2882386 \$1,599 ⁹⁹			
SIXR Luster	2881359 \$1,599 ⁹⁹		2881362 \$1,999 ⁹⁹					
SIXR Matte Black	2881360 \$1,479 ⁹⁹	2883144 \$1,539 ⁹⁹	2881363 \$1,799 ⁹⁹	2883207 \$1,599 ⁹⁹	2882387 \$1,599 ⁹⁹			
SPLIT Matte Black	2881404 \$1,479 ⁹⁹	2883145 \$1,539 ⁹⁹	2881405 \$1,799 ⁹⁹					
WHITEOUT R14 Matte Black							2882382 \$2,399 ⁹⁹	

LUG NUTS
LUG NUTS REQUIRED

10MM X 1.25 HEX LUG NUTS

- » 2877385 - 4 HEX LUG NUTS
- » 2877384 - 16 HEX LUG NUTS Sportsman XP®

3/8" - 24 HEX LUG NUTS

- » 2876754 - 4 HEX LUG NUTS
- » 2877409 - 16 HEX LUG NUTS Polaris ACE®, SPORTSMAN® 450/570

REPLACEMENT CAPS

POLARIS® CAPS

LUSTER	All WHEELS EXCEPT WYDE & HEXLR	1521509-410 • \$15 ⁹⁹
MATTE BLACK		1521509-521 • \$15 ⁹⁹

PRO ARMOR® CAPS

LUSTER	All WHEELS EXCEPT WYDE & HEXLR	5453209-410 • \$15 ⁹⁹
MATTE BLACK		5453209-458 • \$15 ⁹⁹

TIRE SEALANT

- » 32 OZ. • 2830484 • \$23⁹⁹
- » 1 GALLON • 2830485 • \$82⁹⁹
- » 5 GALLON • 2830486 • \$346⁹⁹
- » 5 GALLON PUMP • 2830487 • \$154⁹⁹

COLBY VALVE SHORT ULTIMATE VALVE - 2 PACK

» 2883292 • \$54⁹⁹

COLBY VALVE EMERGENCY VALVE - 2 PACK

» 2883293 • \$54⁹⁹

ALL-TERRAIN TRACTION

It's tough to make Sportsman® and Polaris ACE® even more versatile than they already are. But with a set of Prospector Pro® Tracks, you'll do just that. Tread through deep snow without concern.

Polaris®-specific gearing provides 1:1 ratio to:

- Minimize track slip, providing better climbing ability and improved traction in deep snow
- Improve top speed over prior models by approximately 5%
- Reduce operating RPM for a quieter ride
- Improve driveline durability, which allows vehicle to run at a lower RPM, decreasing engine wear

New front dual stabilizer for improved stability

Polaris® Exclusive optimized hub geometry that minimizes feedback and eases steering effort

Lightweight design provides for better flotation, eases steering effort, and provides better vehicle control

Flexible lug design provides the highest level of deep snow performance by lifting up in deep snow as opposed to digging down



PROSPECTOR PRO TRACK SYSTEM

MODELS	TYPE	STEP 1 SELECT A MOUNT	STEP 2 SELECT A KIT
SPORTSMAN® 570 EPS '15-19 SPORTSMAN® 570 SP '15-19 SPORTSMAN® TOURING 570 SP '15-19 SPORTSMAN® X2 570 '15-19	EPS	2879497 \$569 ⁹⁹	2881025 \$5,419 ⁹⁹
SPORTSMAN XP® 1000 '17-19 SPORTSMAN® 850 SP '18-19	EPS	2882109 \$569 ⁹⁹	2881003 \$5,419 ⁹⁹
SCRAMBLER® 1000 '15-19 SPORTSMAN® TOURING XP 1000 '15-19 SPORTSMAN® TOURING 850 SP '15-19	EPS	2879457 \$569 ⁹⁹	2881003 \$5,419 ⁹⁹
SPORTSMAN® 570 '14-19 SPORTSMAN® TOURING 570 '15-19	NON-EPS	2879497 \$569 ⁹⁹	2880020 \$5,419 ⁹⁹
SCRAMBLER® 850 '13-19 SPORTSMAN® 850 '15-19	NON-EPS	2879457 \$569 ⁹⁹	2879720 \$5,419 ⁹⁹
SPORTSMAN XP® 1000 '18-19	NON-EPS	2882109 \$569 ⁹⁹	2879720 \$5,419 ⁹⁹
570 6X6 '17-19	EPS	2882169 \$7,739 ⁹⁹ Includes Track Mount & Track Kit	

WANT TO PLOW? GLACIER® PRO PLOW TRACK EXTENSION



» 2879719 • \$249⁹⁹

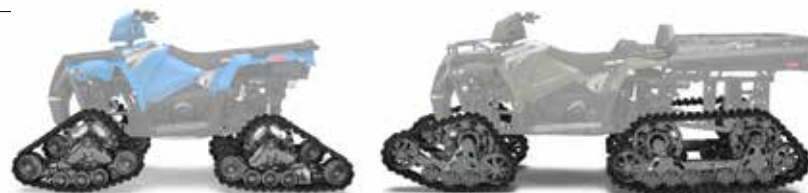

- Plow extension for use when using the prospector pro track system and Glacier® Pro Sportsman® or Polaris ACE® plow system

FOR USE WITH GLACIER® PRO SPORTSMAN® AND POLARIS ACE® PLOW SYSTEMS



WANT TO PLOW? SEE PAGE 44

SPORTSMAN® SNOW TRACTION OPTIONS

TREAD THROUGH SNOW WITH THESE OPTIONS	CONTACT PATCH	TURNING RADIUS
 <p>STOCK TIRES</p>	<p>GOOD</p> 	 <p>139.5"</p>
 <p>PRO ARMOR® WHITEOUT</p>	<p>BETTER</p>  <p>MORE SURFACE AREA FOR BETTER FLOTATION ON SNOW</p>	 <p>138.875"</p>
 <p>PROSPECTOR PRO® TRACKS</p>	<p>BEST</p>  <p>LESS AGGRESSIVE TREAD DISPLACES SNOW FOR BETTER HANDLING</p>	 <p>175.375"</p>

GLACIER®

PLOW SYSTEM

When you have the power of a Glacier® Pro Plow System on your machine, you can truly take command of clearing snow and moving whatever you need to. Find the blade that fits your needs and you'll make quick work of even the heaviest jobs.



BUILD YOUR PERFECT PLOW SYSTEM

***GLACIER**
PLOW SYSTEM

ADD HYDRAULICS



CONTROL FROM THE PALM OF YOUR HAND

Change the angle of the plow blade with the Power Controller.



HYDRAULIC CONTROL FOR EXTREME SNOW REMOVAL

A robust frame and tough blades, combined with the option to add a hydraulic control, allow your Glacier® PRO HD to move serious snow while you remain comfortable. Thanks to Lock & Ride® technology, the PRO HD system allows you to easily add or remove the plow blade without pins or tools.

GLACIER® PRO HD GIVES YOU » 66", 60" or 52" Blades » Choice of poly or steel » Ability to add a hydraulic angle system

THE POLARIS ENGINEERED™ ADVANTAGE

INSTALLATION

30 seconds: Drive up, clip in, lock down, and go – the integrated Polaris Engineered™ Glacier® Plow System simplifies plowing.

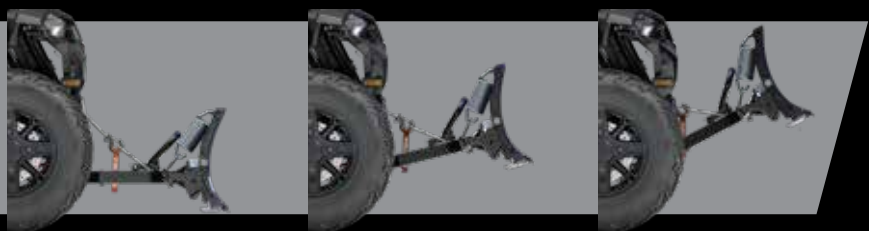

CONVENIENCE

Lift and angle adjustments can be made from the driver's seat.

ANGLE YOUR BLADE RIGHT FROM YOUR SEAT WITH THE GLACIER® PRO PLOW HYDRAULIC ANGLE SYSTEM



ROBUST FRAME

A plow system is only as strong as its frame, and Polaris Engineered™ plow frames have a wide frame to withstand the rigors of heavy plowing.



DURABILITY

Available in strong stamped steel or corrosion-resistant poly materials, Polaris Engineered™ plow blades cover a large surface area for quick snow removal.

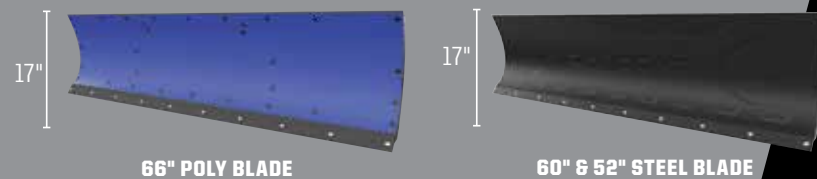

66" POLY BLADE

60" & 52" STEEL BLADE

MODELS	MANDATORY STEPS				OPTIONAL
	STEP 1 SELECT A MOUNT	STEP 2 SELECT A FRAME	STEP 3 SELECT PLOW CONFIGURATION		STEP 4 ADD HYDRAULICS
	MOUNT	FRAME	WINCHES	BLADES	HYDRAULICS
XP 1000 '15-19 850/850 SP '15-19 850/XP 1000 HIGHLIFTER '16-19 TOURING XP 1000 '15-19 TOURING 850 SP '15-19 SCRAMBLER® '15-19	2881423 \$229 ⁹⁹	2879630 \$339 ⁹⁹	Polaris® PRO HD 3500 lb. Winch 2882241 \$699 ⁹⁹ Polaris® HD 3500 lb. Winch 2880435 \$609 ⁹⁹ Polaris® HD 2500 lb. Winch 2880433 \$509 ⁹⁹	66" Poly 2880269 \$539 ⁹⁹ 60" Steel 2879638 \$339 ⁹⁹ 52" Steel 2879639 \$279 ⁹⁹	Hydraulic Angle System 2879635 \$739 ⁹⁹ Power Controller 2880836 \$134 ⁹⁹ Power Controller Recommended
570 SP '15-19 570 '15-19 570 6X6 '17-19 X2 570 '15-19 TOURING 570 SP '15-19 TOURING 570 '15-19 450 H.O. '16-19 ETX '15	2879633 \$229 ⁹⁹				
570 '14 TOURING 570 '14 500 '12-14 500 H.O. '12-13 TOURING 500 '13 800 '12-14 400 H.O. '12-14	2881424 \$229 ⁹⁹				
POLARIS ACE® 570 SP '14-16 POLARIS ACE® 570 '15-16 POLARIS ACE® '14-16	2879634 \$269 ⁹⁹		Polaris® PRO HD 3500 lb. Winch 2882243 \$699 ⁹⁹ Polaris® HD 3500 lb. Winch 2882106 \$609 ⁹⁹ Polaris® HD 2500 lb. Winch 2882105 \$509 ⁹⁹		
POLARIS ACE® 900 XC '17-19 POLARIS ACE® 570 SP '17 POLARIS ACE® 570 '17-19 POLARIS ACE® 500 '17-19	2882107 \$229 ⁹⁹				

STEP 5 SELECT ACCESSORIES & REPLACEMENT ITEMS

ACCESSORIES & REPLACEMENT ITEMS

66" HD Wear Bar 2879868 \$134 ⁹⁹ 66" Wear Bar 2879867 \$74 ⁹⁹ 60" Wear Bar 2877243 \$59 ⁹⁹ 52" Wear Bar 2877210 \$54 ⁹⁹	66" Snow Deflector 2879866 \$114 ⁹⁹ 60" Snow Deflector 2871808 \$89 ⁹⁹ Skid Shoe 2205071 \$36 ⁹⁹ Shear Pin 2205063 \$17 ⁹⁹	Plow Winch Rope 2878483 • For 2,500 & 3,500 winches \$38 ⁹⁹ Plow Marker 2872726 • Sold in Pairs \$43 ⁹⁹ 25" / 26" Tire Chains 2881422 • Recommended for rear tires only \$129 ⁹⁹ Extension for Tracks 2879719 • Required for track equipped vehicles \$249 ⁹⁹
--	---	--

NEED TRACKS? SEE PAGE 42



ADVANCED TECH

RIGID® lights are driven by Aluminum PCB Smart Boards™.6063-T5 aircraft aluminum extruded housings and Tiger Drylac® UV protection polyester powdercoating.

EXCLUSIVE OPTICS

RIGID® lights feature impact-resistant polycarbonate lenses for a 100% water/dustproof seal.

RIGID® LIMITED LIFETIME WARRANTY

If you own a RIGID® light and it breaks, we will replace or repair it for life.*

RUGGED CONSTRUCTION

Pro Armor® lights are designed to be big and beefy with an aggressive style all their own, and housed in IP67 marine-grade rated UV polyester powdercoating.

MASSIVELY BRIGHT

Pro Armor® builds bright lights designed for any riding experience. All that power is directed through heat dissipating aluminum for streamlined heat management.

LIGHT BAR TYPES



SR-SERIES PRO

Sleek, powerful, low-profile (under 2" tall). Lights extreme distances with low energy usage.
Available in 10"



D-SERIES PRO

Compact to fit almost anywhere with high output and low energy usage.
Available in Driving, Flood & Spot



SEE THE RIGID® LIGHTING BUYERS GUIDE ON THE POLARIS® YOUTUBE CHANNEL Search "RIGID"



DUAL-ROW LED LIGHT BARS

The most spread and farthest illumination downrange. Easy to mount.
Available in Cube, 10" & 20"



SINGLE-ROW LED LIGHT BARS

Powerful, compact, low-profile light bars with sleek look.
Available in 20"



CUBE LED LIGHTS

Small size allows mounting in strategic locations for added lighting.
Available in Flood & Spot

LIGHT BAR OPTIONS

OPTICS DRIVING

FLOOD

SPOT

COMBO

OPTICS



BUILD YOUR VISION

Consider the Optics, Angle & how you will use your vehicle to choose the right light or set of lights.

OPTICS LIGHT ANGLE	ACCENT	DRIVING (45°)	FLOOD (25°)	SPOT (10°)	COMBO (25°/10°)
DRIVING SPEED	All	Slow	Medium	Fast	Medium to Fast
BEAM	Diffused glow	Extra-wide	Wide/Shorter	Concentrated/Long	Inner Spot & Outer Flood
RECOMMENDED MOUNTING	Low/Wheel well	All points	Low &/or rear	High points	All points
TERRAIN & RIDING STYLE	Added style & personalization in any terrain	All riding & utility	Wide-open terrain or trails & utility	Trail & tight conditions	All riding & utility

COMPARE LIGHTS IN A REAL WORLD SETTING AT POLARIS.COM/LIGHTING

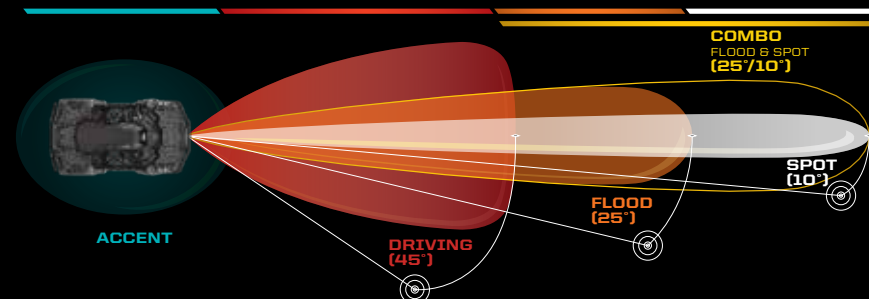

ACCENT LIGHTING

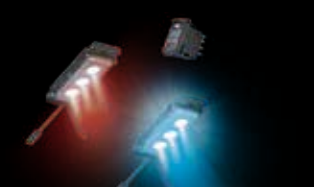

ACCENT LIGHTING KIT

- Durable off-road ready construction that is both dust- and water-resistant
- Features CREE® LED for a long-lasting, brilliant light
- Set includes four LED pods

COLOR	LIGHTING KIT
RED	2880500 • \$209 ⁹⁹
BLUE	2880506 • \$209 ⁹⁹

ALL FULL-SIZE SPORTSMAN® MODELS & FULL-SIZE POLARIS ACE®, DOES NOT FIT ACE® 150.

* If RIGID® determines, in its sole discretion, that your product is defective in material or workmanship, RIGID® will honor your warranty claim. In some cases the product will be replaced, depending on the specific timeframe of the purchase. If the product is repaired, all parts, labor, and return shipping may be covered by RIGID®.

WIRING HARNESSES

LED LIGHT BAR HARNESS

- Control one light with one switch
- » 2882320 • \$74⁹⁹
ALL SPORTSMAN® MODELS.

LED HARNESS WITH TWO CONNECTORS

- Y-Harness requires 2882320 to control two cubes or two lights with one switch
- » 2879860 • \$23⁹⁹
ALL SPORTSMAN® MODELS.

PROTECT THE GEAR YOU NEED. LIVE THE LIFE YOU LOVE.

KOLPIN STRONGHOLD® SYSTEM

Polaris® is proud to partner with Kolpin® Outdoors, an industry leader in off-road accessories and the premier name in gun boots and mounts. If you need to secure a firearm, ice fishing rods, an ice auger or a pop-up blind while riding, simply attach the auto-latch mount and choose your case.

IDEAL FOR SCOPED RIFLES, SHOTGUNS AND LONG-BARRELED PISTOLS

KOLPIN STRONGHOLD® PRODUCTS SECURELY PROTECT THE ESSENTIALS WHEN ON THE TRAIL.
WWW.KOLPIN.COM

STEP 1 CHOOSE YOUR MOUNT



2882272

STEP 2 CHOOSE YOUR BOOTS



Includes Transport Case

AUTO-LATCH MOUNT

- Precision angle adjustable for a custom fit
- Provides a quick and secure attachment point

» 2882300 • \$94⁹⁹ » 2882272 • \$94⁹⁹

ETX '15, 570 SP '15-19, 570 '14-19, 450 H.O. '16-19 DOES NOT WORK ON 450 UTILITY MODELS

XP 1000 '17-19, 850/850 SP '17-19 DOES NOT FIT IF BODYGUARD BUMPER 2882090 IS INSTALLED

GUN BOOT® XL – TRANSPORT

- Lockable and TSA Approved
- 52" L x 3 3/4" W x 10 1/2" H

» 2882430 • \$129⁹⁹

Requires Auto-Latch Mount (2882272 or 2882300)

GUN BOOT® L – IMPACT

- 52" x 4 3/4" x 9 1/4" H

» 2882426 • \$83⁹⁹

Requires Auto-Latch Mount (2882272 or 2882300)

PISTOL BOOT

- 15 1/2" L X 2 1/2" W x 8 1/4" H

» 2882429 • \$69⁹⁹

Requires Auto-Latch Mount (2882272 or 2882300)

ICE AUGER / POP-UP BLIND BOOT

- 46" L X 12 1/2" W

» 2882427 • \$109⁹⁹

Requires Auto-Latch Mount (2882272 or 2882300)

ICE ROD BOOT

- 39" x 18 1/2" x 6" H

» 2882428 • \$129⁹⁹

Requires Auto-Latch Mount (2882272 or 2882300)

KOLPIN® RHINO GRIP®

IDEAL FOR BOWS, CROSSBOWS AND UNCASSED LONG GUNS



LOCK & RIDE RHINO GRIP PRO BY KOLPIN® **NEW**

» 2884119 • \$109⁹⁹

» 2884109 • STRAP • \$11⁹⁹

ALL SPORTSMAN® MODELS (EXCEPT UTILITY EDITIONS & YOUTH)
ALL ACE® MODELS (EXCEPT 150)



LOCK & RIDE RATCHETING RHINO GRIP® BY KOLPIN®

» 2881157 • \$83⁹⁹

ALL SPORTSMAN® MODELS (EXCEPT UTILITY EDITIONS & YOUTH)
ALL ACE® MODELS (EXCEPT 150)



LOCK & RIDE RHINO GRIP XL DOUBLE BY KOLPIN® **NEW**

» 2884120 • \$90⁹⁹

» 2881621 • STRAP • \$7⁴⁹

ALL SPORTSMAN® MODELS (EXCEPT UTILITY EDITIONS & YOUTH)
ALL ACE® MODELS (EXCEPT 150)



LOCK & RIDE RHINO GRIP XL BY KOLPIN®

» 2881513 • \$55⁹⁹

» 2881621 • STRAP • \$7⁴⁹

ALL SPORTSMAN® MODELS (EXCEPT UTILITY EDITIONS & YOUTH)
ALL ACE® MODELS (EXCEPT 150)

POLARIS® GUN BOOTS BY KOLPIN®

» BLACK • 2872677 • \$83⁹⁹

» MOSSY OAK® BREAK-UP® • 2872677-419 • \$119⁹⁹

LOCK & RIDE GUN BOOT® MOUNTS

- High-impact case secures firearm over any terrain
- Lock & Ride® system mounts on right side
- Works with Lock & Ride® XL Storage Box, Lock & Ride® Rear Cargo Box, and Rear Rack Extenders

» 2877381 • \$169⁹⁹

850/XP 1000 HL '16-19, 850/850 SP '09-16

» 2878001 • \$169⁹⁹

TOURING XP 1000 '15-19, TOURING 850 SP '15-19

» 2879888 • \$169⁹⁹

570 SP '15-19, 570 '14-19, 450 H.O. '16-19

» 2881143 • \$169⁹⁹

POLARIS ACE® 570 '15-19, POLARIS ACE® 500 '17-19

THANKS TO OUR PARTNERS. We would like to thank our partners Browning® and Mathews® for helping to deliver a successful and safe off-road experience when out in the field.



Browning® is a registered trademark of Browning, Mathews® is a registered trademark of Mathews Archery Inc.

KEEP IT ICE COLD



POLARIS NORTHSTAR® COOLERS can survive just about anything - from extreme heat to a nasty tumble off a vehicle. So when we say ice will stay cold for hours on end and anything inside will stay locked up tight, we mean it.

POLARIS NORTHSTAR® COOLER



- | | | | | |
|--|---|---|--|--|
| 105 QUART
» GRAPHITE • 2883426 • \$509⁹⁹
» DESERT • 2883392 • \$509⁹⁹ | 60 QUART
» GRAPHITE • 2883425 • \$409⁹⁹
» DESERT • 2881259 • \$409⁹⁹ | 30 QUART
» GRAPHITE • 2883424 • \$309⁹⁹
» DESERT • 2881315 • \$309⁹⁹ | 15 QUART <i>NEW</i>
» GRAPHITE • 2883968 • \$249⁹⁹ | 20 QUART SOFTSIDE
» GRAPHITE • 2883390 • \$209⁹⁹ |
|--|---|---|--|--|

30, 60 & 105 QUART FEATURES

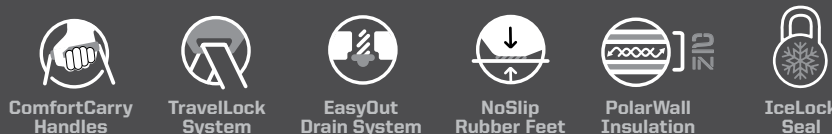

- TUMBLERS**
- » 30 OZ • 2883394 • **\$36⁹⁹**
 - » 20 OZ • 2883393 • **\$30⁹⁹**

GRIZZLY TESTED. POLARIS® APPROVED.



This cooler is IGBC-approved, meaning it withstands the power expended by a typical grizzly bear if it was trying to get inside. Seriously, there are experts who know what a grizzly is capable of doing, and they certify that the Polaris Northstar® Cooler can take it.



POLARIS NORTHSTAR® COOLER ACCESSORIES



- WIRE BASKET**
- » 105 QUART • 2883648 • **\$59⁹⁹** *NEW*
 - » 60 QUART • 2882185 • **\$43⁹⁹**
 - » 30 QUART • 2882438 • **\$36⁹⁹**



- DIVIDERS**
- » 105 QUART • 2883468 • **\$43⁹⁹** *NEW*
COMES WITH ONE DIVIDER
 - » 60 QUART • 2882184 • **\$59⁹⁹**
COMES WITH TWO DIVIDERS
 - » 30 QUART • 2882186 • **\$30⁹⁹**
COMES WITH ONE DIVIDER
- Divider doubles as a cutting board



SEAT CUSHION

- » 60 QUART • 2882179 • **\$114⁹⁹**
- » 30 QUART • 2882507 • **\$89⁹⁹**

COOLER WHEELS

- » 60 QUART • 2882180 • **\$124⁹⁹**

BOTTLE OPENER

- » 2882183 • **\$15⁹⁹**
ALL COOLERS

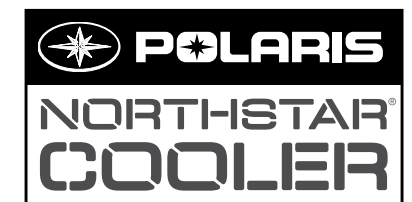

HOLDS ICE
30+
HOURS
LONGER
THAN YETI®*

*YETI is a registered trademark of YETI COOLERS, LLC

ENGINEERED TO MAXIMIZE THE LIFE OF YOUR RIDE

All Polaris® fluids—from AGL to Demand Drive Fluid—are developed for your vehicle. Trust the only fluids perfectly engineered for your needs.



SPECIFIC NEEDS, SPECIFIC OILS

Polaris® invests millions in engine development, and part of that investment is making sure its lubricants—critical to engine performance—are the right formula for your specific engine. The amount of testing data and engineering resources used in developing Polaris® lubricants would overwhelm an aftermarket company. Therefore, the aftermarket must produce an oil to an industry-wide standard that must account for a variety of operating parameters.

PS-4 is designed specifically for Polaris® 4-cycle engines and has high film strength and wear protection under extreme loads and temperatures. Exclusive anti-wear additives protect engine parts with extra rust and corrosion protection.



Everything needed to change your oil! The correct filter & amount of oil for your vehicle.



PS-4 OIL CHANGE KIT (OIL & FILTER)		PS-4 [EXTREME DUTY] OIL CHANGE KIT (OIL & FILTER)	
PART NUMBER	VEHICLE FITMENT	PART NUMBER	
2202166	RANGER®/RZR®/SPORTSMAN® 570, TWIN 600, TWIN 700, TWIN 800	2879004	
2879323	RANGER®, POLARIS GENERAL®, RZR® 900/1000, RS1	2879324	
2877473	RANGER®/SPORTSMAN® 300-500, SPORTSMAN®/SCRAMBLER® 500/850/1000	2878924	
2881696	RZR® TURBO	2881697	



PS-4 FULL-SYNTHETIC OIL

PS-4 is optimal for ambient operating temperatures of -40° C to 38° C

- » .95 L • 2876244
- » 3.8 L • 2876245
- » 60.6 L • 2876247



PS-4 EXTREME-DUTY FULL-SYNTHETIC OIL

PS-4 Extreme Duty is optimal for ambient operating temperatures of -18° C to 54° C

- » .95 L • 2878920
- » 3.8 L • 2878919
- » 60.6 L • 2879003



ORV MAINTENANCE KIT

This convenient kit includes everything you need, in the correct fluid volumes, to properly maintain your drive train, and keep your vehicle in top operating condition.

- Includes: 1.4 L AGL, .95 L Angle Drive Fluid, 1 pint Demand Drive Fluid, 1-3 oz. tube of All-Season Grease
- » 2880425

PROVEN PROTECTION

Powersports grade, full-synthetic base oils and proprietary additive systems outperform leading automotive and aftermarket engine oils in 75 hour severe duty engine testing.

PS-4 vs. AUTO OIL

60% MORE ROD END BEARING WEAR PROTECTION WITH PS-4



WORN & GROOVED

+ 40% LESS CYLINDER WEAR WITH PS-4

+ 30% LESS GRAFAL WEAR* WITH PS-4

*The purpose of the grafal coating is primarily to decrease friction and protect the piston from wear.



PS-4 RACE PROVEN PERFORMANCE

"The Baja 1000 is probably the toughest race in the world! In the brutal Baja desert there are so many things that can ruin your race it is great to know that Polaris Engineered Lubricants will never let us down.

We trust in the Polaris products like the PS-4 motor oil to protect our machines vitals, they are a critical part of a winning formula."

**BILL SCHUELER
CREW CHIEF JAGGED X**

MAINTENANCE FLUIDS



OIL
Maximum protection for your 4-cycle engine. Exclusive anti-wear additives protect your engine and extend the life of engine components.
Change every 100 hours, 6 months or 800 km.



AGL
Extreme pressure additives protect gears, drive chain, and bearings from scoring and wear. Unlike typical gear case oils, AGL's unique viscosity range allows instant flow and film protection in extreme cold or high heat environments.

Change every 100 hours, 12 months or 1600 km.

- » .95 L • 2878068
- » 3.8 L • 2878069
- » 9.5 L • 2878070
- » 208 L • 2879594



U-JOINT GREASE

A heavy-duty lubricant formulated with molybdenum disulfide to accept the high shock applications of Polaris' ATV shaft drive universal joints.

Add every 50 hours, 3 months or 800 km.

- » 89 ml • 2871515
- » 414 ml • 2871551

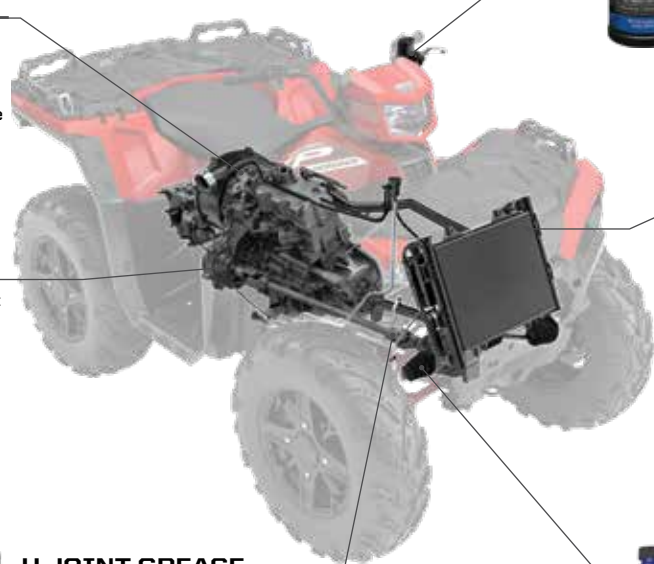

DOT 4 BRAKE FLUID

A high-quality brake fluid designed for use in Polaris' hydraulic brakes. Superior high-temp characteristics plus anti-corrosive additives extend the life of brake system components and provide consistent, positive braking.

Change every 200 hours, 3200 km or every 2 years.

- » 355 ml • 2872189



ANTI-FREEZE

Organic acid technologies to prevent corrosion on metal components, eliminate scaling, and maximize cooling system performance.

Change every 60 months.

- » .95 L • 2880514
- » 3.8 L • 2880513
- » 208 L • 2880512



DEMAND DRIVE FLUID

Provides positive 4WD engagement in extreme cold or high heat conditions. Unique friction additives protect internal components under heavy loads and promote positive engagement.

Change every 100 hours or yearly.

- » .95 L • 2877922
- » 9.5 L • 2877923



PREMIUM GAS SHOCK OIL

- » .95 L • 2870995
 - » 9.5 L • 2872279
- Fox® REBUILDABLE SHOCKS

10WT GAS SHOCK OIL

- » .95 L • 2874124
- Walker EVANS® REBUILDABLE SHOCKS

CHAIN LUBRICANT

- » 473 ml AEROSOL 2872348

ALL-SEASON GREASE TUBE

- » 89 ml • 2871322
- » 414 ml • 2871423

ANGLE DRIVE FLUID

- » .95 L • 2876160
 - » 9.5 L • 2872276
- Sportsman®, RANGER®, RZR® ANGLE DRIVE GEAR CASE SYSTEMS

CARBON CLEAN

Prevents ethanol corrosion, stabilizes fuel, and cleans fuel injectors, piston ring lands, intake systems, and combustion chambers. Helps maintain peak HP and improves fuel economy.

- » 355 ml • 2881413

ADVANCED FUEL TREATMENT

Prevents ethanol corrosion and stabilizes fuel for up to 2 years. Dual-antioxidant formula protects against gum and varnish for easy starting.

- » 355 ml • 2881416
- » 9.5 L • 2881417

LUBRICANT ACCESSORIES



GREASE GUN KIT

- » 2871312 • \$44⁹⁹
- Fits 2871322 ALL-SEASON AND 2871322 U-JOINT 88.7 ml



2D BATTERY-OPERATED SIPHON PUMP

- Liquid transfer pumps 5-6 quarts/ min suctioning power
 - Use with gas, water, oil, and other non-corrosive liquids
- » 2830513 • \$20⁹⁹



FLEX SPOUT

- Convenient easy pour flex spout fits all Polaris' quart, gallon, and 9.5 L bottles

- » 2871285 • \$3⁹⁹



PUMP

- Attaches to 3.8- or 9.5-liter bottle for easy, no-drip dispensing

- » 2870465 • \$9⁹⁹

TIRE SEALANT

HOW IT WORKS

Tire sealant remains liquefied inside your tire until a leak develops in the tire or wheel.



Once a leak occurs, the tire sealant rushes out of the tire and quickly creates a permanent solid plug.

The plug maintains the pressure of the tire so you can continue your ride.

PREMIUM TIRE SEALANT

- Instantly seals and repairs rim, bead leaks, and punctures up to 0.64 cm on standard tires, and 1.9 cm on heavy ply tires
- Will not rust, corrode, or pit wheels
- Creates permanent repair
- Helps maintain air pressure for the life of the tire
- Remains fluid and effective in temperatures down to -43° C
- Helps seal the tire bead against the wheel
- Easily installed through existing tire valve stem with valve core removed
- 100% water soluble for easy cleanup

- » 946 ml • 2830484 • \$23⁹⁹
- » 3.8 LITER • 2830485 • \$82⁹⁹
- » 19 LITER • 2830486 • \$346⁹⁹
- » 19 LITER PUMP • 2830487 • \$154⁹⁹

- » 208 LITER • 2830489
- » 1041 LITER • 2830488



24 X 7 COVERAGE | BE PREPARED FOR ANYTHING

NOTHING CAN STOP YOU.

COVERAGE WHEN YOU NEED IT.

FIX ON THE GO | TEMPORARY COVERAGE

CV BOOT REPAIR KIT*

- A quick trail side fix to increase trail time.
- The flexible and durable boot material expands over a cone tool for CV boot repairs, without disassembling CV axles.
- Universal fit - works as a temporary fix for most powersports axles.
- All components fit inside the cone, and a cover is provided for compact durable storage.
- Easily fits in a cargo box, attached to the roll cage, in the glovebox, or many other storage locations.



Items shown are contained inside cone

ATV CV BOOT REPAIR KIT

Kit includes the following items:

- (1) Expandable CV Boot
- (1) Reusable Cone Tool
- (2) CV Boot Clamps
- (1) Tube of Silicone Lube
- (1) Grease Packet
- (1) Cone Cover

- » 2830528 • \$31⁹⁹

ATV TRAIL BOOT ONLY

- » 2830529 • \$17⁹⁹

UTV

- » CV REPAIR KIT 2830526 • \$35⁹⁹
- » TRAIL BOOT ONLY 2830527 • \$17⁹⁹

SEE HOW THE CV BOOT REPAIR KIT WORKS AT POLARIS.COM/MAINTENANCE-VIDEOS

HOW TO INSTALL

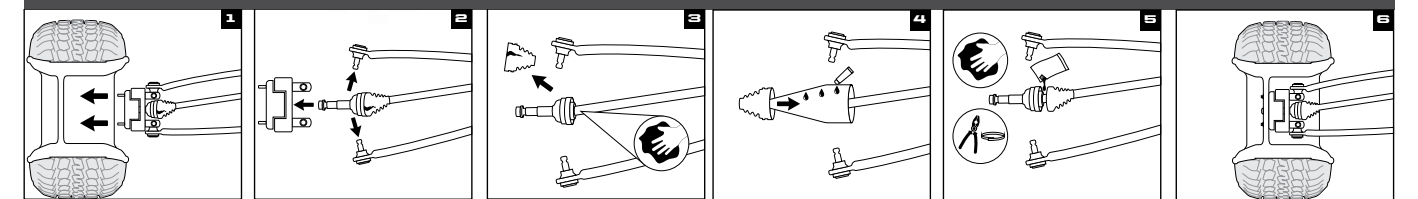

1. Remove wheel and axle nut
2. Remove brake caliper, hub, tie rod, & upper & lower ball joints
3. Remove old boot & clean joint
4. Spread silicone lube on entire cone tool. Slide boot over cone tool, large end first. See package for outer boot instructions.
5. Empty the bag of grease into the CV joint/boot, clean sealing points & install clamps
6. Reassemble tie rod, ball joints, brake caliper, axle nut, tire & wheel

Refer to your owner's manual for further instructions and torque specifications.

*Designed for temporary CV boot repair. Purchase the OEM CV Boot for a permanent repair.

FOR THE LIFE OF YOUR RIDE

THE KEY TO KEEPING YOUR POLARIS® OFF-ROAD VEHICLE PERFORMING as well as the day you brought it home is proper maintenance. Items like belts, filters, and batteries represent only a few of these critical items engineered specifically by Polaris®.

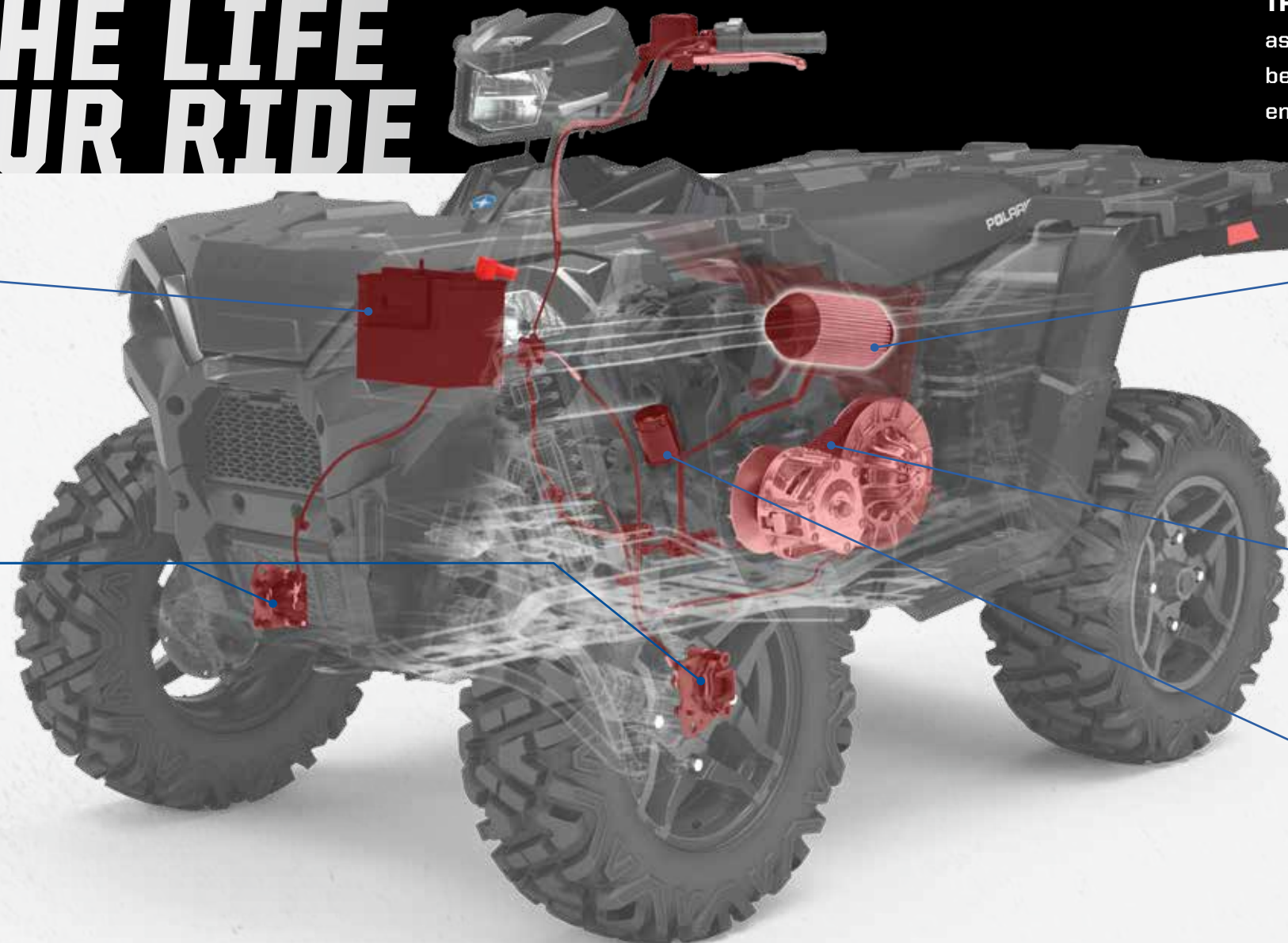

BATTERIES

Never leave a battery unattended during the storage season. To ensure your battery maintains its level of charge when unused for extended periods of time or during freezing weather, the battery should be connected to a BatteryMINDER®. Be sure to check for corrosion from the terminals to the ends of the cables.

BRAKE PADS

Check your brakes if you are close to the recommended service interval, hear grinding when applying the brakes, your vehicle is taking longer to stop or if you have to apply more pressure to your pedal to engage the brakes. Check the brake discs for signs of cracks, excessive corrosion or warping.

If the brake pads are contaminated with oils or grease (petroleum products), brake pads have to be discarded and replaced.

Discs need to be cleaned with brake cleaner or alcohol based cleaner only.

AIR FILTERS

Critical to engine performance and reliability. A clogged air filter can restrict air flow to the engine leading to reduced engine performance. Dirt and debris ingestion can damage the engine leading to reduced engine life or catastrophic failure. Polaris® recommends changing the vehicle's air filter at the specified intervals outlined in the owner's manual, which may be shorter if your vehicle is subject to severe conditions.

DRIVE BELTS

Polaris Engineered® belts deliver unmatched performance for your off-road vehicle. Developed and tested on all our engines for all environments and conditions. Check your belt for delamination, hour glassing and glazing.

OIL FILTERS

Change oil filters with every oil change to provide the best protection for your engine. Superior engine protection keeps your engine operating at peak performance. Be sure to follow the suggested service intervals for oil/oil filter changes.

MAINTENANCE TIP

BREAK-IN PERIOD

The break-in period for your new Polaris Sportsman® is the first 25 hours of operation, or the time it takes to use the first two tanks of fuel. No single action on your part is as important as a proper break-in period. Careful treatment of a new engine will result in more efficient performance and longer life for the engine. Perform the listed procedures carefully.

NOTICE: Excessive heat build-up during the first three hours of operation will damage close-fitted engine parts. Do not operate at full throttle or high speeds for extended periods during the first three hours of use.

SEE OUR LATEST MAINTENANCE TIPS AT [POLARIS.COM/MAINTENANCE-VIDEOS](https://www.polaris.com/maintenance-videos)



MAINTENANCE SCHEDULE

25 HRS/400 km	50 HRS/800 km	100 HRS/1600 km	150 HRS/2400 km	200 HRS/3200 km	350 HRS/4020 km	500 HRS/8045 km	CHECK YOUR OWNER'S MANUAL FOR ADDITIONAL RECOMMENDED SERVICE ITEMS AND VEHICLE-SPECIFIC TIMING
BREAK-IN MAINTENANCE ENGINE OIL: CHANGE GENERAL LUBRICATION: ALL FITTINGS, PIVOTS, CABLES, ETC. AIR FILTER: INSPECT & CLEAN REPLACE AS NEEDED EXHAUST SYSTEM: INSPECT & CLEAN INSPECT FOR LEAKAGE OR CARBON BUILD UP AT JOINTS INSPECT & CLEAN SCREEN TYPE SPARK ARRESTOR	6 MONTHS EXHAUST SYSTEM: INSPECT & CLEAN INSPECT FOR LEAKAGE OR CARBON BUILD UP AT JOINTS INSPECT & CLEAN SCREEN TYPE SPARK ARRESTOR GENERAL LUBRICATION: ALL FITTINGS, PIVOTS, CABLES, ETC. DRIVE BELT: INSPECT & ADJUST REPLACE AS NEEDED	12 MONTHS ENGINE OIL: CHANGE DRIVE BELT: INSPECT & ADJUST REPLACE AS NEEDED TRANSMISSION FLUID: CHANGE EXHAUST SYSTEM: INSPECT & CLEAN INSPECT FOR LEAKAGE OR CARBON BUILD UP AT JOINTS INSPECT & CLEAN SCREEN TYPE SPARK ARRESTOR	18 MONTHS ENGINE OIL: CHANGE BATTERY: TEST, CLEAN, & CHECK FLUID LEVEL REPLACE AS NEEDED DRIVE BELT: INSPECT & ADJUST REPLACE AS NEEDED TIRES: INSPECT CONDITION & PRESSURE EXHAUST SYSTEM: INSPECT & CLEAN INSPECT FOR LEAKAGE OR CARBON BUILD UP AT JOINTS INSPECT & CLEAN SCREEN TYPE SPARK ARRESTOR	24 MONTHS ENGINE OIL: CHANGE BRAKE PADS & FLUID: INSPECT & CLEAN REPLACE AS NEEDED SPARK PLUGS: INSPECT REPLACE AS NEEDED EXHAUST SYSTEM: INSPECT & CLEAN INSPECT FOR LEAKAGE OR CARBON BUILD UP AT JOINTS INSPECT & CLEAN SCREEN TYPE SPARK ARRESTOR	30 MONTHS ENGINE OIL: CHANGE BATTERY: TEST, CLEAN, & CHECK FLUID LEVEL REPLACE AS NEEDED DRIVE BELT: INSPECT & ADJUST REPLACE AS NEEDED GENERAL LUBRICATION: ALL FITTINGS, PIVOTS, CABLES, ETC. EXHAUST SYSTEM: INSPECT & CLEAN INSPECT FOR LEAKAGE OR CARBON BUILD UP AT JOINTS INSPECT & CLEAN SCREEN TYPE SPARK ARRESTOR	36 MONTHS ENGINE OIL: CHANGE AIR FILTER: INSPECT, CLEAN REPLACE AS NEEDED COOLANT: CHECK LEVEL REPLACE EVERY 2 YEARS GEARCASES: CHECK OIL LEVEL EXHAUST SYSTEM: INSPECT & CLEAN INSPECT FOR LEAKAGE OR CARBON BUILD UP AT JOINTS INSPECT & CLEAN SCREEN TYPE SPARK ARRESTOR	CHECK YOUR OWNER'S MANUAL FOR ADDITIONAL RECOMMENDED SERVICE ITEMS AND VEHICLE-SPECIFIC TIMING

SERVICE PARTS

Polaris Engineered™ service parts deliver unmatched performance and fit for your off-road vehicle.

All service parts are developed and tested for your vehicle. **Half shafts, bushings, bearings, decals, side panels, electrical components, and clutching components** are the same parts that are manufactured on the factory lines for each specific vehicle. This ensures it doesn't merely fit your vehicle - it outperforms your expectations!

SHOP FOR SERVICE PARTS ONLINE OR VISIT YOUR POLARIS® DEALER.

CHECK OUT OUR PARTS FINDER ON POLARIS.COM
FOR EASY PARTS LOOK-UP, PARTS IDENTIFICATION, VIEWS OF ASSEMBLIES & MORE!

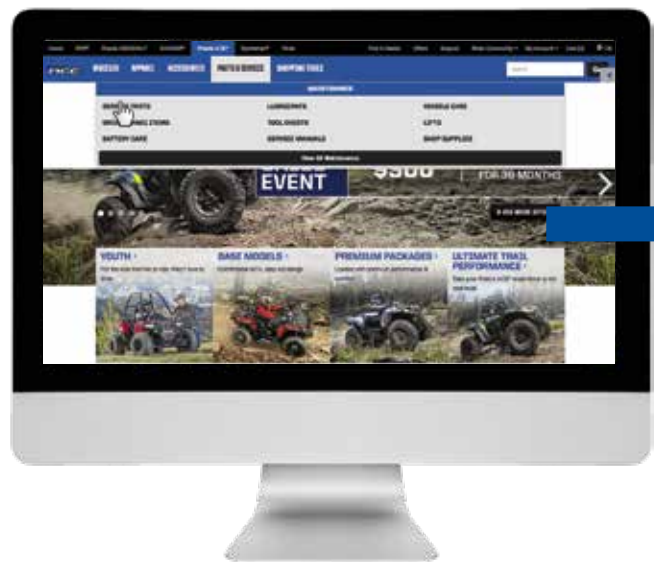

STEP 1

Visit Polaris.com/SPORTSMAN or Polaris.com/ACE

Click "Parts & Service" tab

Click "Service Parts"

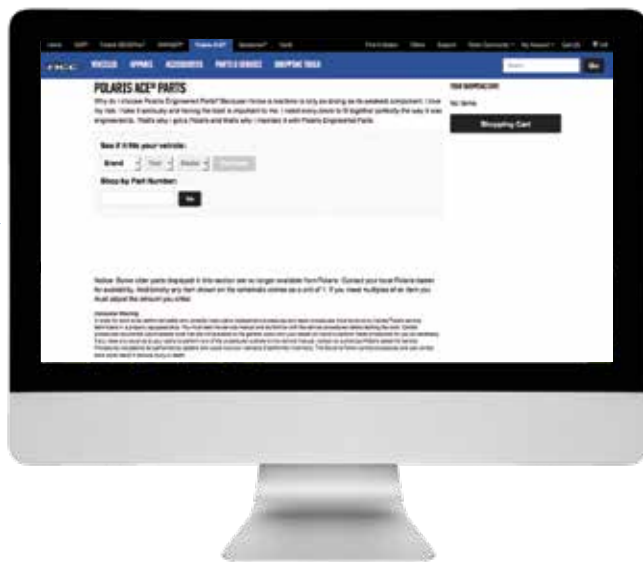

STEP 2

Enter **vehicle year/model** or shop by **part number**



STEP 3

Clearly see what parts are required and **order**

Assembly
DRIVE TRAIN FRONT HALF SHAFT - A17DAAB07 (10004)

A17DAAB07 ACE 800 SONG (2017) (R14)

Zoom In Zoom Out

Qty	Part#	Description	Price	Qty	
1	133240	ASM-SHAFT-HALF-FRONT	\$249.99	2	Add
2	209801	K-JOINT, CV (INCL. BALL, INTER RACE, CAGE, BELL)	\$74.99	1	Add
3	209802	K-BOOT, OUTER (INCL. CLAMPS, BOOT, GREASE)	\$16.19	1	Add
4	209803	K-HALF-SHAFT BAR (INCL. SHAFT, CLIPS)	\$29.99	1	Add
5	209804	K-BOOT, INNER (INCL. CLAMPS, BOOT, GREASE)	\$16.19	1	Add
6	209805	K-DOG, INNER (INCL. CLIP, RING, RACE, BALLS, BELL)	\$29.99	1	Add
7		KIT, SNAP RING SET	Contact Dealer		
8	209807	GREASE	Contact Dealer		

Notice: Some older parts displayed in this section are no longer available from Polaris. Contact your local Polaris dealer for availability. Additionally any item shown on the schematic comes as a unit of 1. If you need multiples of an item you must adjust the amount you order.



OVER
100,000
PARTS
AVAILABLE!

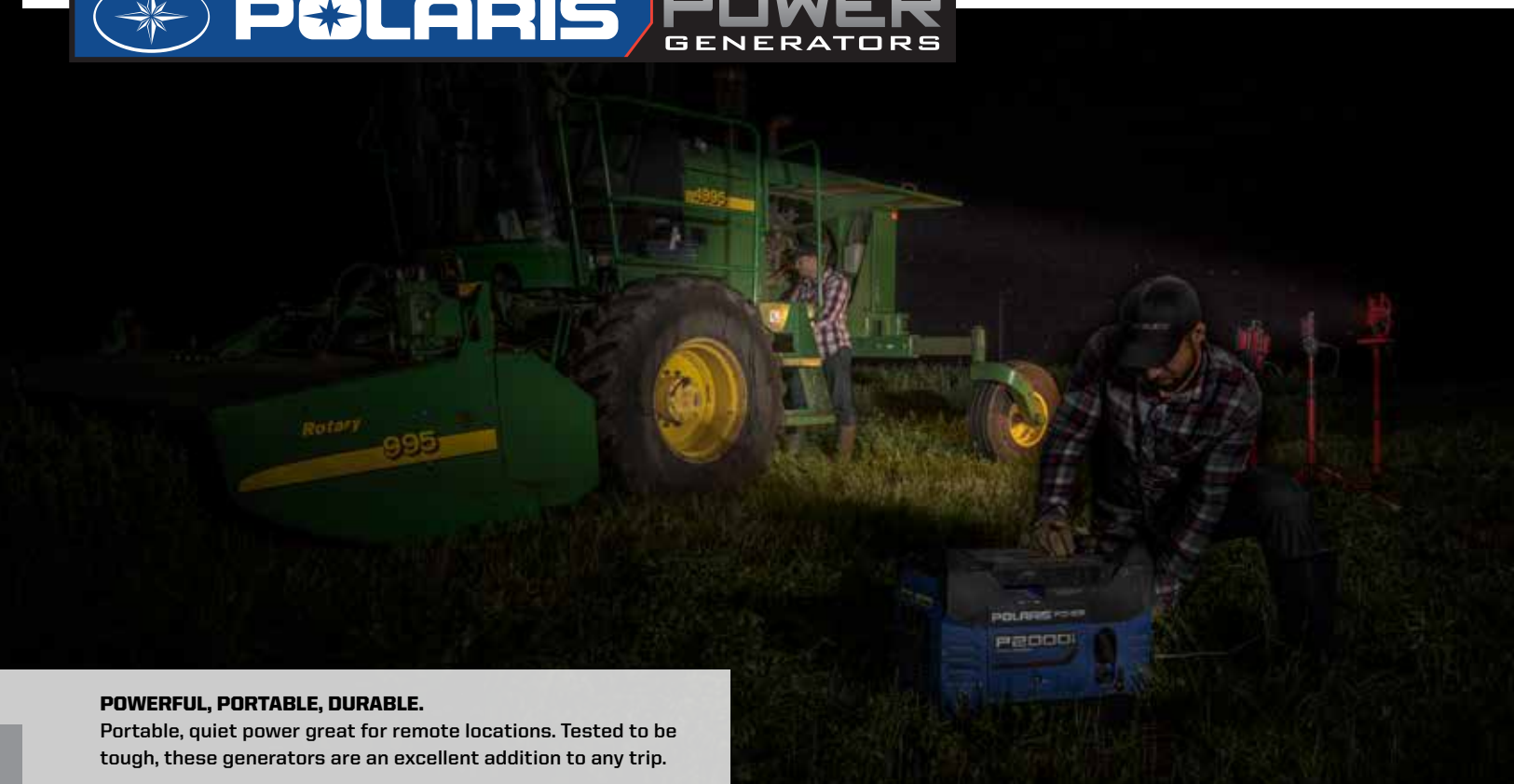

POWERFUL, PORTABLE, DURABLE.

Portable, quiet power great for remote locations. Tested to be tough, these generators are an excellent addition to any trip.

WHICH GENERATOR FITS YOUR NEEDS?

- 1 Add up the running watts of everything you might power at the same time.
- 2 Pick the device with the highest running watts and add its starting watts to the previous total.
- 3 Select a generator with a slightly higher wattage.

	Startup Wattage	Running Wattage
140 cm LCD TV	0	150
CROCK POT	0	200
RADIO	0	50-200
LAPTOP	0	200-250
625W MICROWAVE	0	625
FRIDGE OR FREEZER	700	700
COFFEE MAKER	1300	800
SUMP PUMP: 1/3 HP	1300	800
BLENDER	1000	1000
ELECTRIC GRIDDLE	0	1500
18 cm CIRCULAR SAW	1700	1400
AIR CONDITIONER	1500	1500

POLARIS POWER® INVERTER GENERATORS



P1000i

1000 WATT
PORTABLE / QUIET

- Dual handles and only 16.5 kg
- Connect two units together for even more output
- Quieter than casual conversation (54db @ 25%)
- Up to 10 hours on 1 tank of gas

» P13GDGANA • \$659 ⁹⁹

P2000i

2000 WATT
VERSATILE / LIGHTWEIGHT

- Dual handles and only 24 kg
- Connect two units together for even more output
- Quieter than casual conversation (54db @ 25%)
- Up to 10 hours on 1 tank of gas

» P13G0GBNA • \$959 ⁹⁹

P3000i

3000 WATT
ROBUST / ELECTRIC START

- Locking 360 degree pivoting wheels
- Easy electric start for minimal effort
- Quieter than casual conversation (56db @ 25%)
- Up to 21.5 hours on 13 L of gas

» P13G0GCNA • \$1,899 ⁹⁹

PORTABLE POWER



POLARIS® FLEX JUMPSTARTER

- 12,000 mAh capacity. Two 5V/2.1A USB outputs, 200-lumen flashlight, and a digital battery life monitor. Includes storage case, smart jumper cables, car charger, wall charger, and user guide.
- 1-year limited warranty.
- Jumpstart any engine up to 6.4L. The Polaris® Flex Jumpstarter is small enough to be stored in your glovebox and holds its charge so you can count on it when it's needed.

» 2830495 • \$143 ⁹⁹

GENERATOR ACCESSORIES



POLARIS POWER® COLD WEATHER KIT

- Ensure smooth running of your Polaris® Generator in sub-zero temperatures
- Prevents ice blockage in the crankcase breather tube, which may lead to operational issues including oil leakage
- Installation required, no need to disconnect for warm weather operation
- Exclusively designed for use with Polaris® P1000i & P2000i inverter generators

» 2881433 • \$124 ⁹⁹



POLARIS POWER® CABLE KIT

- Use a parallel cable kit to easily connect two Polaris Power® generators together to increase the total power available to a load

» 3410281 • \$189 ⁹⁹



POLARIS POWER® TIE-DOWN LEADS

- Secure your Polaris Power® Generator by inserting the Lock & Ride® Tie Down Leads into the handle and running a strap across to tie down the generator
- Secures Lock & Ride® accepting gear
- Safely provides a point for 2.5 cm wide tie-down strap

» 2880959 • \$16 ⁹⁹



POLARIS POWER® GENERATOR OIL

- Corrosion inhibitors protect against rust and oxidation during long-term storage

» 1 QUART • 2879383



POLARIS POWER® GENERATOR STORAGE COVERS

- Keep your generator looking like new with a strong, durable cover that is resistant to mold, mildew, tears, and abrasions

» 1000 WATT COVER • 2686441
\$37 ⁹⁹

» 2000 WATT COVER • 2686442
\$43 ⁹⁹

» 3000 WATT COVER • 2686443
\$49 ⁹⁹

BatteryMINDER®

ENSURE YOUR RIDE IS READY WHEN YOU ARE!

- Add years of capacity, power and range to new and older batteries, regardless of type or brand
- Never over or under charged in any temperature
- Leave your vehicle connected for months and return to fully charged and conditioned batteries
- Recover older-weak batteries that would normally need to be replaced
- Charge and maintain extra-backup batteries as well as those in your vehicle
- Automatic turn-on, sleeps while keeping your batteries at full-charge
- Easy Push-Button selector to change battery type or time







	BatteryMINDER® 2012 AGM 2 AMP	BatteryMINDER® 1510 1.5 AMP	BatteryMINDER® 1.5 AMP CONVERTIBLE
PRICE	\$119 ⁹⁹	\$77 ⁹⁹	\$89 ⁹⁹
PART NUMBER	2830438	2830404	2830511
VOLTAGE	12	12	12
CHARGING CURRENT	2 AMP	1.5 AMP	1.5 AMP
OVERCHARGE PROTECTION	Yes	Yes	Yes
BATTERIES MAINTAINED AT ONE TIME	6	4	4
WARRANTY	5 Years	10 Years	5 Years
BATTERY COMPATIBILITY	12 Volt Sealed AGM Lead-Acid	12 Volt flooded (filler cap) and sealed maintenance free batteries	12 Volt flooded (filler cap) and sealed maintenance free batteries
COMES WITH	• Non-fused battery clip cord set with Quick Connector	• Ambient temperature sensor (installed) • 12ft. power cord • Battery clip cord set with Quick Connector • Optional Permanent Mounting Tab	• Auto-Temp compensation sensor (installed) • Optional permanent mounting brackets & screws • Battery clips (fully-insulated, aircraft grade, 15A replaceable fuse) • Ring terminal assembly with 15A replaceable fuse
KEY FEATURES	Designed for high performance specialty AGM sealed batteries	Easy to use, economical	Convertible on-vehicle or bench top use

BATTERY MAINTENANCE TIPS

Extend your battery life with a BatteryMINDER® and these tips.

1. Store batteries in a cool, dry location.
2. Check that the battery connections are tight. Cables should not be able to be rotated or shifted by hand.
3. If your battery has a drain tube, make sure it is free of clogs.
4. Clean your battery - use a soft brush to scrub the top of the battery. Use baking soda to remove grease.
5. Connect a BatteryMINDER® after using your vehicle even if the vehicle is in regular use.

BatteryMINDER® ACCESSORIES

 <p>BatteryMINDER® VPP-12/12/24 VOLT VEHICLE POWER PLUG</p> <ul style="list-style-type: none"> • Allows easy connection to vehicle's battery through lighter or 12/24V power port with replaceable 15 amp fuse. <p>» 2830518 • \$12⁹⁹</p>	 <p>BatteryMINDER® 3.7 m EXTENSION CABLE</p> <ul style="list-style-type: none"> • Made with heavy-duty 16 gauge black zip cord featuring automotive SAE bullet connectors <p>» 2830410 • \$15⁹⁹</p>	 <p>BatteryMINDER® MULTI-BATTERY SPLITTER</p> <ul style="list-style-type: none"> • A simple, safe, and affordable way to connect two batteries simultaneously for easy battery maintenance • Includes a set of ring terminals <p>» 2830409 • \$29⁹⁹</p>	 <p>BatteryMINDER® RING TERMINAL KIT</p> <ul style="list-style-type: none"> • Features 61 cm long 18-gauge wire • Plug has standard .8 cm negative and .95 cm positive terminals • Replaceable 15 amp in-line fuse for circuit protection • SAE quick connector and cap <p>» 2830437 • \$11⁹⁹</p>	 <p>BatteryMINDER® EZ CONNECT</p> <ul style="list-style-type: none"> • Allows for quick and easy connecting and disconnecting of your BatteryMINDER® • Includes a set of ring terminals <p>» 2830411 • \$39⁹⁹</p>
--	---	--	---	--

LIFT IT SECURELY LIFT IT SAFELY



POLARIS® VEHICLE LIFT

- Get fast, easy access to the underside of your vehicle
- Manual and pneumatic operation available
- Raises vehicle up to 81 cm to make repairs and maintenance faster and easier

» 544 kg • 2830424 • \$839⁹⁹

LIFT ATTACHMENTS

- Add the appropriate attachment to use your lift for all your off-road vehicles

» ATV/POLARIS ACE® • 2830427 • \$199⁹⁹
» SNOWMOBILE • 2830426 • \$199⁹⁹





POLARIS® X3 CREEPER

- Three positions: flat, 45-degree angle or seated work stool
- Helps you perform any repair with ease
- Stay dry and warm away from cold, wet cement floors
- Easily stores away when not in use

» BLACK • 2830429 • \$179⁹⁹



SHOP ACCESSORIES

 <p>POLARIS® MAGNETIC PARTS TRAY</p> <p>» SILVER • 2830432 • \$14⁹⁹</p>	 <p>POLARIS® 8.4 cm TELESCOPIC MAGNET</p> <p>» BLACK • 2830435 • \$5⁹⁹</p>	 <p>POLARIS® 30.5 cm HI-TORQUE RATCHETING DRIVER</p> <p>» BLACK / BLUE • 2830434 • \$23⁹⁹</p>	 <p>POLARIS® LED POCKET FLASHLIGHT</p> <p>» BLACK • 2830436 • \$31⁹⁹</p>
--	---	--	---

BRING IT EVERYWHERE

TRAILERING



RAMP PRO BY CALIBER®

- Designed for ATVs and UTVs up to 127 cm wide
- Integrated grip glides for ultimate traction
- Folding sides for easy transportation & storing
- » 132 cm x 229 cm • 2883005 • \$519⁹⁹



ALUMINUM ARCHED LOADING RAMPS

- » 193 cm x 30.5 cm • 907 kg • 2875384 • \$279⁹⁹
- » 224 cm x 30.5 cm • 1361 kg • 2875386 • \$459⁹⁹



LIGHTWEIGHT TRI-FOLD RAMPS

- Ramp folds up for transport
- Capacity for up to 680.7 kg
- Safety straps included
- » 183 cm x 130 cm • 2875385 • \$309⁹⁹
- » 208 cm x 130 cm • 2875860 • \$369⁹⁹



FOLDING ALUMINUM ARCHED RAMPS

- Ramp folds up for transport
- Capacity up to 1361 kg
- Safety straps included
- » 224 cm x 30.5 cm • 2875387 • \$379⁹⁹

HITCHES

3:1 HITCHES VERSATILE 3 IN 1 FUNCTIONALITY

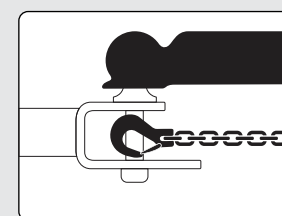

BALL



NEW HITCH WITH 2" BALL

- » 2" x 2" RECEIVER 2830522 • \$47⁹⁹
- » 1 1/4" x 1 1/4" RECEIVER 2830523 • \$47⁹⁹

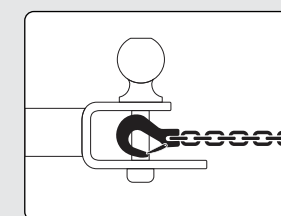

HOOK



NEW 1 7/8" BALL

- 1 7/8" replacement ball for hitch
- Designed to work with 3:1 Hitch
- » 2830524 • \$11⁹⁹

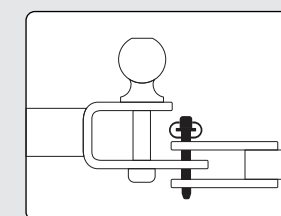

PIN



RECEIVER HITCH

- » 2" RECEIVER TONGUE 2875320 • \$59⁹⁹
- » FRONT HITCH RECEIVER 2878846 • \$169⁹⁹



TRAILER BALL 3/4" SHANK

- » 1 7/8" BALL • 2877602 • \$18⁹⁹
- » 2" BALL • 2877603 • \$18⁹⁹

- Ball, pin and hook design
- Durable steel construction
- Rust resistant, black powdercoated finish
- Removable ball
- Heavy Duty 5/8" pin and clip

STRAPS & ROPES

NEW RECOVERY STRAP

- 5cm x 30' (8165 kg)
- Comes with carry bag
- » 2884033 • \$74⁹⁹



NEW RATCHET STRAP

- 3.8 cm x 4.6 m straps, 2 Pack
- Heavy duty webbing
- 2495 kg maximum load, 831 kg working load
- » 2884031 • \$59⁹⁹



NEW RATCHET STRAP

- 5 cm x 6.1 m Ratchet Straps
- Heavy duty webbing, floating D-rings, double J-hooks
- 4536 kg maximum load, 1497 kg working load
- » 2884032 • \$43⁹⁹



SHOCK STRAPS

- 3.8 cm 1361 kg breaking strength
- Keeps tension on tie-down straps to secure load, 2 Pack
- » 3.8 cm x 4.6 m • 2883296 • \$109⁹⁹
- » 3.8 cm x 2.1 m • 2883295 • \$94⁹⁹



COVERS



TRAILERING COVERS BY POLARIS®

- » 2876614 • \$209⁹⁹
- ALL SPORTSMAN® EXCEPT 300/400, X2, TOURING
- » 2877999 • \$209⁹⁹
- ALL SPORTSMAN® TOURING

- » 2877998 • \$209⁹⁹
- ALL SPORTSMAN® X2
- » 2880056 • \$299⁹⁹
- ALL POLARIS ACE® EXCEPT 900 XC

KEEP IT CLEAN

CLEAN YOUR VEHICLE

PRE-TREAT

MUD SHIELD® PRE-TREATMENT

- Inhibits the adhesion of dirt, mud, and snow, making cleaning your vehicle faster and easier.

» 473 ml AEROSOL • 2830229 • \$13⁹⁹

NEVER RUST SPRAY®

- Synthetic formula highly resistant to water protects against rust and corrosion while lubricating metal surfaces.

» 473 ml AEROSOL • 2830230 • \$14⁹⁹

CLEAN

XP WASH®

- Foaming, highly-concentrated wash easily removes the most stubborn and intense dirt build-up.

» 946 ml • 2830225 • \$14⁹⁹

XP SPRAY WASH®

- Effortless biodegradable, high-performance wash ideal for removing dirt, oils and carbon—simply spray on, spray off and go.

» 946 ml • 2830224 • \$18⁹⁹

ALL-PURPOSE CLEANER

- Professional grade, non-streak, foam formula cuts through grease, dirt and film leaving an invisible, dirt-resistant barrier for long-lasting results.

» 473 ml • 2830227 • \$13⁹⁹

GLASS CLEANER

- Heavy-duty foam non-streak formula cuts through grease, dirt, dried bugs and film leaving a crystal clear dirt-resistant barrier for long-lasting results.

» 473 ml • 2830445 • \$5⁹⁹

SHINE

POLARIS POLISH

- Easy protection and shine—spray on, wipe off, and go. For ideal use on painted and plastic surfaces. Contains carnauba wax.

» 335 ml • 2830228 • \$11⁹⁹

INSTANT SHINE & DETAILER

- Spray and wipe formula—cleans, polishes, and protects plastic and painted surfaces.

» 473 ml • 2830226 • \$12⁹⁹

CLEAN YOUR SHOP

TOWELS

POLARIS® SHOP TOWELS

- » 200 CT WITH DISPENSER 2830402 • \$26⁹⁹
- » 200 CT REFILL • 2830403 • \$18⁹⁹
- » 64 CT REFILL • 2830440 • \$5⁹⁹



POLARIS® HEAVY-DUTY SCRUBBER WIPES

» 90 CT • 2830441 • \$29⁹⁹



PROFESSIONAL GRADE CLEANERS

VEHICLE

VEHICLE & EQUIPMENT WASH

- Concentrated professional grade formula powers through vehicle buildup, dirt and grease with a spot-free rinse. Treat up to 32 gals. Biodegradable product.

» 3.8 L • 2830417 • \$19⁹⁹

» 19 L • 2830422 • \$69⁹⁹

SHOP

ALL-PURPOSE CLEANER PLUS

- Professional-grade formula removes built-up stains from shop floors, work benches, and other hard surfaces. VOC-free, environmentally-friendly, and biodegradable.

» 3.8 L • 2830414 • \$19⁹⁹

» 19 L • 2830416 • \$69⁹⁹

HD CLEANER & DEGREASER

- Professional-grade, biodegradable, high-foaming formula dissolves and removes tough stains and soils.

» 3.8 L • 2830418 • \$23⁹⁹

» 19 L • 2830420 • \$95⁹⁹



ORV RIDING JERSEY

- » S-3XL • \$39⁹⁹
- 2868711 • LIME
- 2867941 • PINK
- 2867942 • RED



SOFTSHELL JACKET

- Lined with 280 grams of fleece for warmth
- Removable hood
- Armpit zips for venting
- » S-3XL • \$169⁹⁹
- » MEN'S
2869919 • BLUE/ORANGE
2869918 • BLACK
- » WOMEN'S
2869921 • CORAL
2869920 • BLACK

FIND YOUR PERFECT HELMET!
RIDE SAFE - OUR HELMETS ARE DOT/ECE CERTIFIED



509° ALTITUDE CARBON HELMET

- Durable, ultra lightweight, Carbon Fiber
- Full carbon fiber shell
- 1100 grams
- » S-4XL • \$519⁹⁹
- 2867814 • MATTE BLACK
- 2867815 • GLOSS BLACK



509° ALTITUDE HELMET

- Stylish, Lightweight with 509 Fit and Finish
- Thermoplastic poly alloy out shell
- 1260 grams

- » S-4XL • \$299⁹⁹
- 2868539 • LIME
- 2867820 • BLUE
- 2867818 • ORANGE
- 2867819 • RED
- 2867817 • GRAY



TENACITY HELMET

- All the style and protection in our most affordable helmet
- Injection molded plastic
- 1450 grams

- » XS-3XL • \$144⁹⁹
- 2868624 • PINK GLOSS
- 2868620 • BLACK/GRAY
- 2868622 • BLUE GLOSS
- 2868619 • BLACK MATTE
- 2868623 • RED GLOSS
- 2868621 • LIME GLOSS

PROTECT YOUR HANDS

OFF-ROAD RIDING GLOVES

- As seen in images at left
- » S-3XL • \$32⁹⁹
- 2867937 • PINK
- 2867933 • GRAY
- 2868712 • BLUE/LIME
- 2867936 • RED
- 2867935 • ORANGE
- 2867934 • BLUE

COOL

WARM

BE PREPARED FOR ANYTHING NATURE THROWS AT YOU



COOLING SHIRTS

- 100% Poly, chemical-free patented fabric from CoolCore®
- Moisture wicking to keep you dry and cool
- UPF 45+
- » S-3XL • \$59⁹⁹
- » MEN'S
2868753 • GRAY
- » WOMEN'S
2868755 • GRAY/PINK



KINGPIN DIRT 509° GOGGLE

- Quick change lens & triple layer foam
- Anti-fog & anti scratch
- » ONE SIZE • \$74⁹⁹
- 2868671 • LIME
- 2868668 • ORANGE

COOL



NEW RAIN SUIT

- Lightweight
- Waterproof
- Packs small
- Removable hood
- YKK® zippers
- » JACKET • 2869527
- S-3XL • \$129⁹⁹
- » PANT • 2869528
- S-3XL • \$109⁹⁹

DRY



STAY WARM AND CHARGE YOUR PHONE

NEW HEATED VEST

- Three heat settings for changing weather
- Down-proof material
- Removable hood
- Powered by a small rechargeable battery (included)
- Battery can be recharged via USB or any 12V outlet
- Charge a cell phone with the rechargeable battery
- Machine washable
- » MEN'S • S-3XL • \$269⁹⁹
- 2869924 • DARK GRAY
- » WOMEN'S • S-3XL • \$284⁹⁹
- 2869923 • DARK GRAY

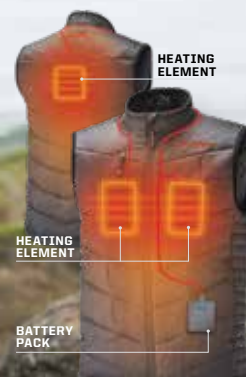

WARM



WOMEN'S ASYMMETRICAL HOODIE

» S-3XL • \$74⁹⁹
BLACK • 2868597

WOMEN'S ROSEAU TEE

» S-3XL • \$32⁹⁹
GRAY FROST • 2869559
BLACK • 2868586



MEN'S RETRO LOGO HOODIE

» S-3XL • \$74⁹⁹
BLACK • 2869549
CHARCOAL/LIME • 2869578
GRAY/ORANGE • 2868577

MEN'S RETRO CAP

» ONE SIZE • \$32⁹⁹
NAVY/LIME • 2869543

MEN'S ROSEAU HOODIE

» S-3XL • \$74⁹⁹
CHARCOAL HEATHER • 2869553
NAVY HEATHER • 2868575
OLIVE HEATHER • 2868576



WOMEN'S CAMO HOODIE

» S-3XL • \$74⁹⁹
CAMO/PINK • 2867898

MEN'S CAMO TECH FULL ZIP

» S-3XL • \$79⁹⁹
CAMO • 2869590



MEN'S LONG SLEEVE TECH 1/4 ZIP

» S-3XL • \$79⁹⁹
BLACK/RED • 2869535
GRAY/LIME • 2869536



MEN'S RETRO TRUCKER CAP

» ONE SIZE • \$32⁹⁹
RED • 2869540

MEN'S LONG SLEEVE RETRO TEE

» S-3XL • \$54⁹⁹
GRAY • 2868571

WOMEN'S BASEBALL 3/4 SLEEVE TEE

» S-3XL • \$46⁹⁹
WHITE/GRAY • 2869563



MEN'S TRAIL MID LAYER

» S-3XL • \$119⁹⁹
GRAY/BLACK • 2869925

MEN'S TECH MESH BEANIE

» ONE SIZE • \$26⁹⁹
BLACK • 2868650



PINT GLASS SET OF 2

» 2866265 • \$19⁹⁹

RETRO CLOCK

» 2868662 • \$39⁹⁹



CAMO WATER BOTTLE

» 2867962 • \$26⁹⁹

CAMO COFFEE TRAVEL MUG

» 2867961 • \$32⁹⁹

CAMO BOTTLE KOOZIE

» 2867964 • \$14⁹⁹

CAMO CAN KOOZIE

» 2867963 • \$8⁹⁹

CAMO STEERING WHEEL COVER

» 2868663 • \$19⁹⁹

CAMO BOTTLE OPENER [NOT SHOWN]

» 2867965 • \$14⁹⁹



MEN'S ESTA TEE

» S-3XL • \$26⁹⁹
CHARCOAL HEATHER • 2869552
NAVY • 2869562
BLACK • 2868570

MEN'S FULL ZIP HOODIE

» S-3XL • \$74⁹⁹
BLACK/RED • 2869530
NAVY • 2869532 [NOT SHOWN]

MEN'S RETRO CAP

» ONE SIZE • \$32⁹⁹
CHARCOAL • 2869542



WOMEN'S HEX TEE

» S-3XL • \$32⁹⁹
GRAY FROST • 2869566
NAVY FROST • 2869565

WOMEN'S RETRO CAP

» ONE SIZE • \$32⁹⁹
BLUE • 2869547

WOMEN'S SCRIPT CREW SWEATSHIRT

» S-2XL • \$67⁹⁹
AQUA • 2869557

WOMEN'S RETRO HOODIE

» S-3XL • \$67⁹⁹
NAVY • 2869555



MEN'S ROSEAU TEE

» S-3XL • \$32⁹⁹
CHARCOAL HEATHER • 2869560
HEATHER BLUE • 2867778
ASH HEATHER • 2869561

BUILD YOUR POLARIS SPORTSMAN®

1 CHOOSE MODEL

2 CHOOSE TRIM & COLOR

3 CHOOSE ACCESSORIES

VISIT POLARIS.COM/SPORTSMAN

TO SEE ALL YOUR OPTIONS & ACCESSORIES ON YOUR NEW MACHINE FROM EVERY ANGLE!



CONNECT ONLINE
SEARCH "PolarisORV"



KEEP IT COLD.



SEE THE FULL LINE OF COOLERS
INCLUDING THE NEW 15 QT. MODEL
WITH AN EASY CARRY HANDLE

SEE P. 50



UNLESS NOTED, TRADEMARKS ARE THE PROPERTY OF POLARIS INDUSTRIES INC. 509® is a registered trademark of Teton Outfitters, LLC. BatteryMinder® is a registered trademark of VDC Electronics Inc., Bluetooth® is a registered trademark of Bluetooth Sig. Inc., Browning® is a registered trademark of Browning Corporation, Caliber® is a registered trademark of Caliber, Inc., CREE® is a registered trademark of Cree, Inc., COOLCORE® is a registered trademark of Tempnology LLC., FOX® is a registered trademark of Fox Factory Inc., Mathews® is a registered trademark of Mathews Archery Inc., Maxxis® is a registered trademark of Cheng Shin Rubber Ind. Co., Ltd., MB Quart® is a registered trademark of Maxxonics USA Inc., Mossy Oak® is a registered trademark of Haas Outdoors, Inc., MTX® is a registered trademark of Mitek Corporation., OGIO® is a registered trademark of Ogio International, Inc., Rigid® is a registered trademark of Rigid Hitch, Inc., Tiger Drylac® is a registered trademark of TIGER COATINGS GMBH & CO. KG, Walker Evans Racing Shocks® is a registered trademark of Walker Evans Enterprises Corp., Velcro® is a registered trademark of VELCRO BVDA, Yeti® is a registered trademark of Yeti Coolers, LLC, YKK® is a registered trademark of YKK Corporation. Prices and availability are subject to change at any moment. Copyright © 2018 Polaris Industries Inc. All rights reserved.



POLARIS®

MY19 SPTSMN/ACE APP CAN • 9930519