

CANADA VERSION

# POLARIS *GENERAL*

**POP**

ACCESSORIES + APPAREL



# THE RIGHT GEAR ALWAYS MATTERS



## ELEVATE YOUR ADVENTURE

OFF-ROAD'S PREMIER FAMILY OF CROSSOVER SIDE-BY-SIDES. No matter which GENERAL you choose, you begin every adventure with the best performance, the greatest utility, and the most comfortable ride you can get in a side-by-side. When you customize with Polaris Engineered Accessories you have the confidence to take on any task or any trail.

## 2021 LINEUP

SEE THE FULL LINEUP AT [POLARIS.COM/GENERAL](https://www.polaris.com/general)

### GENERAL XP

#### XP 1000 (2 & 4 SEAT)



##### GENERAL XP 1000

- WALKER EVANS VELOCITY SHOCKS
- SPORT ROOF
- POLARIS HD 4,500 LB. WINCH
- STAGE 1 AUDIO SYSTEM BY ROCKFORD FOSGATE®
- SPORT LOW PROFILE FRONT BUMPER
- CONVEX REAR VIEW MIRROR
- 30" PRO ARMOR CRAWLER XG
- XL FENDER FLARES

RIDE COMMAND • STAGE 4 AUDIO SYSTEM BY ROCKFORD FOSGATE® UPGRADE AVAILABLE.

#### XP 1000 PURSUIT EDITION (2 & 4 SEAT)



##### GENERAL XP 1000 PURSUIT EDITION

###### XP PLUS:

- STAGE 1 AUDIO SYSTEM BY ROCKFORD FOSGATE®
- 4-SEAT POLY SPORT ROOF
- FRONT SPORT LOW PROFILE BUMPER
- CONVEX REAR VIEW MIRROR
- PRO ARMOR 11" SINGLE ROW - LED FLOOD LIGHT
- POLARIS HD 4,500 LB. WINCH
- 30" PRO ARMOR CRAWLER XG
- REAR BED STORAGE RACK
- KOLPIN STRONGHOLD GUN BOOT XL TRANSPORT

### GENERAL

#### DELUXE (2 & 4 SEAT)



##### GENERAL 1000 DELUXE

###### PREMIUM PLUS:

- FOX® PODIUM X 2.0 QS3 SHOCKS
- SPORT ROOF
- STAGE 1 AUDIO SYSTEM BY ROCKFORD FOSGATE®
- CONVEX REAR VIEW MIRROR

Now Available in Two Color Packages

RIDE COMMAND • STAGE 4 AUDIO SYSTEM BY ROCKFORD FOSGATE® UPGRADE AVAILABLE.

#### PREMIUM (2 & 4 SEAT)



##### GENERAL 1000 PREMIUM

###### SPORT PLUS:

- AUTOMOTIVE PAINT
- MATTE BLACK CAST ALUMINUM WHEELS
- 27" MAXXIS® CORONADO TIRES
- SPORT LOW PROFILE FRONT BUMPER
- POLARIS HD 4,500 LB. WINCH
- 4-SEAT ONLY: FOX® PODIUM X 2.0 QS3 SHOCKS

#### SPORT



##### GENERAL 1000 SPORT

- 100 HP PROSTAR ENGINE
- 600 LB. DUMPING BOX
- STANDARD HALF DOORS
- ELECTRONIC POWER STEERING (EPS)
- POLARIS LOCK & RIDE COMPATIBLE
- VERSATRAC TURF MODE

## CONTENTS

### ACCESSORIES 06

WINDSHIELDS & REAR PANELS	08
DOORS	10
ROOFS	12
VEHICLE & RIDER PROTECTION	13
STORAGE	14
CAB COMFORT	16
HUNT	18
POLARIS NORTHSTAR COOLERS	20
RIDE COMMAND & AUDIO	22
LIGHTING	24
WHEELS & TIRES	26
WINCHES	34
PLOWS & TRACKS	35

### PARTS & GARAGE 36

MAINTENANCE	36
OIL & LUBRICANTS	38
MAINTENANCE FLUIDS	40
SERVICE PARTS	42
HD PARTS	44
BATTERIES & TIRE SEALANT	46
VEHICLE CARE & TRAILERING	48
POLARIS POWER	50

### APPAREL & HELMETS 54

OUTERWEAR & PROTECTION	54
LIFESTYLE APPAREL & CAPS	60
CAMO & GIFTS	62



BUILD YOUR OWN  
AT [POLARIS.COM/GENERAL](https://www.polaris.com/general)

**DESIGNED**



Designed by the same people who designed your vehicle.

**TESTED**



Extensively tested in the field so you ride with 100% confidence.

**TRUSTED**



ACCESSORIES  
BACKED BY A



WARRANTY

65 years in the business.  
The #1 name in Off-Road.

WE HOLD OUR  
PARTNERS TO THE  
SAME STANDARDS

**PRO ARMOR**



WHEELS, TIRES & LIGHTING DESIGNED WITH  
POLARIS TO MAXIMIZE PERFORMANCE  
P. 25 & 26



A GLOBAL LEADER IN AUDIO INNOVATION,  
DESIGN & ENGINEERING  
P. 23

**RIGID**

PRODUCTS SO GOOD THEY REPLACE  
OR REPAIR THEM FOR LIFE  
P. 24

**KOLPIN**  
OUTDOORS

MAKING PRODUCTS FOR AVID  
SPORTSMEN SINCE 1943  
P. 18

# ENGINEERED TO TAKE ON **THE ELEMENTS**

## TESTED & PROVEN



DUST



WIND

**BUILD YOUR CAB SYSTEM  
STARTING ON P. 08**



## COMFORT YOU HAVE TO EXPERIENCE TO BELIEVE

Our cab components create an experience enhancing interior, offering supreme comfort to your vehicle.



### PROFILE TUBE DESIGN

Contours built into the cage deliver a premium sealing surface.



### PERFECT FIT, PERFECT SEAL

A 360° gasket seal provides our tightest-sealing cab.



### LOCK & RIDE EASY ON & OFF

Adapt to your needs and environment with exclusive tool-less, easy-on, easy-off Lock & Ride components.



### PLUG & PLAY ELECTRICAL

## EFFORTLESSLY ADD LIGHTS, HEAT, WIPERS & AUDIO.

A revolution in electrical accessory integration, the Polaris PULSE Electrical System allows for a simple plug & play approach for adding power to Polaris Engineered Accessories.

Look for  to identify Polaris PULSE ready accessories.





# ELEVATE YOUR ADVENTURE

- LOCK & RIDE** Vented Windshield - Hard Coat Poly: P. 08
- Windshield Wiper & Washer System: P. 08
- LOCK & RIDE** Bed Extender: P. 14
- Polaris Northstar 30 QT Cooler: P. 20
- LOCK & RIDE** Spare Tire Carrier: P. 14
- Pro Armor 33" Combo LED Light Bar: P. 25
- Light Bar Harness: P. 25
- Rear Sport Bumper: P. 13
- 4-Seat Extreme Kick-Out Rock Sliders: P. 13



# BLAZE A NEW TRAIL

- LOCK & RIDE** Vented Windshield - Hard Coat Poly: P. 08
- Sport Roof - Poly: P. 12
- XL Fender Flares: P. 13 **NOT SHOWN**
- LOCK & RIDE** Cargo Box: P. 15
- RIGID® SR-Series Combo Light Bar: P. 25
- Pro Armor Wheel & Tire Set: P. 33
- 29" Mud XC & 14" Shackle - Matte Black
- Winch: P. 34



# PREPARE FOR THE HUNT

- LOCK & RIDE** Full Windshield - Glass: P. 08
- Windshield Wiper & Washer System: P. 08
- LOCK & RIDE** Rear Panel - Glass: P. 09
- Pro Armor 33" Combo LED Light Bar: P. 25
- Polaris Pulse LED Light Bar Harness: P. 16
- In addition to stock accessories*



# SPORT ESSENTIALS

- Premium Roof - Poly: P. 12
- LOCK & RIDE** Full Windshield - Glass: P. 08
- Windshield Wiper & Washer System: P. 08
- LOCK & RIDE** Rear Panel - Glass: P. 09
- Polaris Northstar 30 QT Cooler: P. 20

# WINDSHIELDS

Keep the elements out and control air flow into the cab.

POLARIS ENGINEERED ADVANTAGES

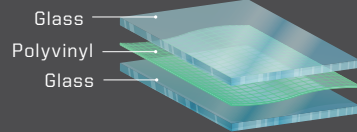

## GLASS VS POLY

- Superior optical clarity (automotive level)
- Scratch resistant
- Curved to fit, seals tight
- Cold weather / heavy duty
- Wiper ready (windshield only)

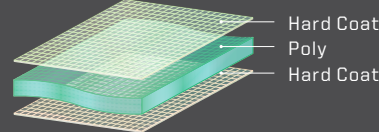

- Lightweight, flexible, easy to store/remove
- Impact-resistant
- Tight seal keeps out rain and dust
- Hard Coat: 30x more scratch resistance than regular poly windshields



LOCK & RIDE

REVOLUTIONARY INSTALLATION



AIRTIGHT GASKET SEAL

### GLASS

### HARD COAT POLY

### POLY

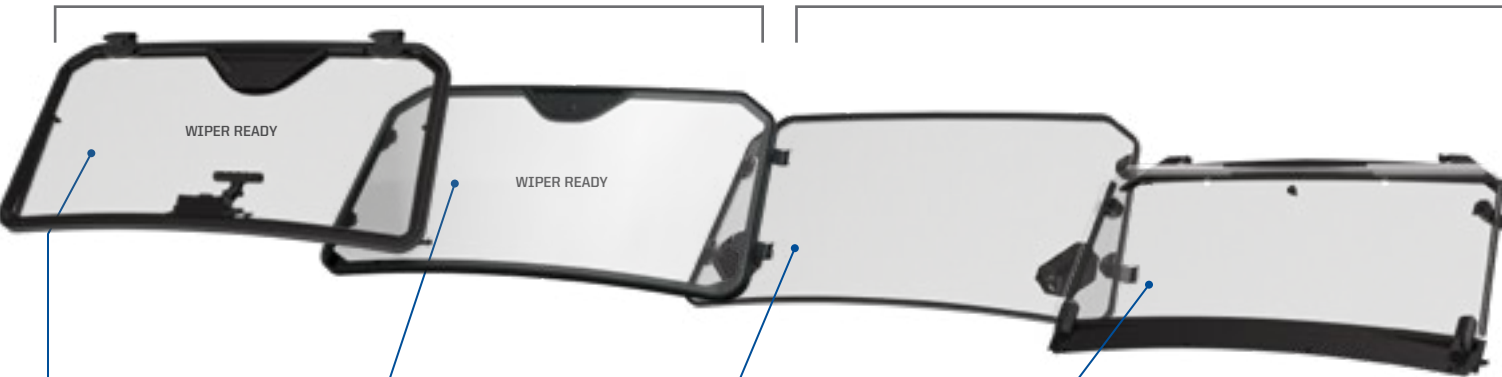

#### TIP-OUT WINDSHIELD - GLASS TOP SELLER

» 2881108 • \$1,599<sup>99</sup>  
POLARIS GENERAL XP 1000/4 '20-21  
POLARIS GENERAL 1000/4 '16-21

NEW

LOCK & RIDE

#### FULL WINDSHIELD - GLASS TOP SELLER

» 2889064 • \$949<sup>99</sup>  
POLARIS GENERAL XP 1000/4 '20-21  
POLARIS GENERAL 1000/4 '16-21

LOCK & RIDE

#### VENTED WINDSHIELD - HARD COAT POLY

» 2884223 • \$729<sup>99</sup>  
POLARIS GENERAL XP 1000/4 '20-21  
POLARIS GENERAL 1000/4 '16-21

NEW

#### FLIP-DOWN WINDSHIELD - HARD COAT POLY

» 2889156 • \$609<sup>99</sup>  
POLARIS GENERAL XP 1000/4 '20-21  
POLARIS GENERAL 1000/4 '16-21

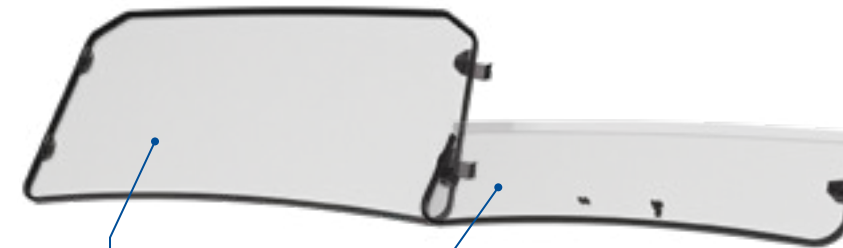

LOCK & RIDE

#### FULL WINDSHIELD - HARD COAT POLY

» 2884337 • \$679<sup>99</sup>  
POLARIS GENERAL XP 1000/4 '20-21  
POLARIS GENERAL 1000/4 '16-21

LOCK & RIDE

#### HALF WINDSHIELD - POLY

» 2881111 • \$269<sup>99</sup>  
POLARIS GENERAL XP 1000/4 '20-21  
POLARIS GENERAL 1000/4 '16-21



#### WINDSHIELD WIPER & WASHER SYSTEM TOP SELLER

» 2881090 • \$739<sup>99</sup>  
POLARIS GENERAL XP 1000/4 '20-21  
POLARIS GENERAL 1000/4 '16-21



Offers fully-sealed or flipped-down venting options. Upper half detaches, leaving lower half for protection with maximum ventilation.

# REAR PANELS

Turbulent air forms above the cargo bed and behind the cab when you add a windshield. This swirl can carry dirt, dust, leaves, and rain into the cab. Eliminate this phenomenon and control the swirl by installing a rear panel.



LOCK & RIDE

#### REAR PANEL - GLASS TOP SELLER

» 2881113 • \$469<sup>99</sup>  
POLARIS GENERAL XP 1000/4 '20-21  
POLARIS GENERAL 1000/4 '16-21



LOCK & RIDE

#### REAR PANEL - POLY

» 2881112 • \$409<sup>99</sup>  
POLARIS GENERAL XP 1000/4 '20-21  
POLARIS GENERAL 1000/4 '16-21

ADD A REAR PANEL TO REDUCE THE DUST SWIRL

ACCESSORIES  
WINDSHIELDS & REAR PANELS  
DOORS  
ROOFS & PROTECTION  
STORAGE, CAB COMFORT & HUNT  
COOLERS  
RIDE COMMAND & AUDIO  
LIGHTING  
WHEELS & TIRES  
WINCHES & PLOWS

# DOORS

**COMPLETE YOUR CAB.** POLARIS GENERAL comes equipped with half doors. To create an enclosed cab for increased protection from the elements, choose from two great Polaris options.



## REPLACE STOCK HALF DOORS

### PREMIUM POLY FULL DOORS

- Impact and scratch-resistant tempered glass
- Fully-sealed design keeps elements out for a premium in-cab environment
- Hinged window adjustability
- Soft-touch, easy-to-clean premium interior liner

#### 2-SEAT

- Six-way glass window adjustability

» 2883717 • **\$3,269**<sup>99</sup>  
 POLARIS GENERAL XP 1000/4 '20-21  
 POLARIS GENERAL 1000/4 '16-21

#### 4-SEAT

- Push-out windows
- Kit includes B-pillar cover seal

» 2883082 • **\$3,469**<sup>99</sup>  
 POLARIS GENERAL XP 4 1000 '20-21  
 POLARIS GENERAL 4 1000 '17-21

POLARIS ENGINEERED ADVANTAGES



PREMIUM INTERIOR HANDLE AND LINER



A PERFECT FIT FOR THE PERFECT SEAL



## ADD UPPER DOORS TO STOCK HALF DOORS

### ZIP WINDOW UPPER DOORS

- Durable, rugged canvas stitched over a robust steel frame
- Lightweight, UV-resistant construction
- Retention straps for increased strength
- Zipper windows for increased venting options
- Mounts easily by drilling into stock doors (drill hole plugs included)

#### 2-SEAT

» 2882548 • **\$1,099**<sup>99</sup>  
 POLARIS GENERAL XP 1000 '20-21  
 POLARIS GENERAL 1000 '18-21

NOT SHOWN

#### 4-SEAT

» 2883453 • **\$2,039**<sup>99</sup>  
 POLARIS GENERAL XP 4 1000 '20-21  
 POLARIS GENERAL 4 1000 '18-21

# ROOFS

Protect yourself from the elements. The right roof shields you from the sun and driving rain.

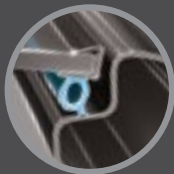

**A PERFECT FIT FOR THE PERFECT SEAL**

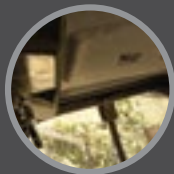

**PREMIUM FEATURES & QUIETER RIDE**



**KEEP MOISTURE MOVING**

**POLARIS ENGINEERED ADVANTAGES**

## ALUMINUM VS POLY

- |                                                                                                                              |                                                                                                                                                           |
|------------------------------------------------------------------------------------------------------------------------------|-----------------------------------------------------------------------------------------------------------------------------------------------------------|
| <ul style="list-style-type: none"> <li>• High protection strength</li> <li>• Lower profile</li> <li>• Sleek style</li> </ul> | <ul style="list-style-type: none"> <li>• Water run-off</li> <li>• Pre-existing mounting features</li> <li>• Liner ready</li> <li>• Lightweight</li> </ul> |
|------------------------------------------------------------------------------------------------------------------------------|-----------------------------------------------------------------------------------------------------------------------------------------------------------|

### 2-SEAT

#### ROOF - ALUMINUM

» 2881105 • \$539<sup>99</sup>  
POLARIS GENERAL XP 1000 '20-21  
POLARIS GENERAL 1000 '16-21



#### PREMIUM ROOF - POLY

» 2883800 • \$709<sup>99</sup>  
POLARIS GENERAL XP 1000 '20-21  
POLARIS GENERAL 1000 '16-21



**INCLUDES PREMIUM ROOF LINER**

#### SPORT ROOF - POLY

» 2883780 • \$409<sup>99</sup>  
POLARIS GENERAL XP 1000 '20-21  
POLARIS GENERAL 1000 '16-21



### 4-SEAT

#### PREMIUM ROOF - POLY

» 2883801 • \$999<sup>99</sup>  
POLARIS GENERAL XP 4 1000 '20-21  
POLARIS GENERAL 4 1000 '17-21



**INCLUDES PREMIUM ROOF LINER**

#### TOP SELLER SPORT ROOF - POLY

» 2883781 • \$669<sup>99</sup>  
POLARIS GENERAL XP 4 1000 '20-21  
POLARIS GENERAL 4 1000 '17-21

#### POLY ROOF LINER

» 2883802 • \$339<sup>99</sup>  
POLARIS GENERAL XP 4 1000 '20-21  
POLARIS GENERAL 4 1000 '17-21  
Compatible with Sport Roof - Poly (2883781), sold separately



# VEHICLE & RIDER PROTECTION

Arm your POLARIS GENERAL with Polaris Engineered bumpers and guards to take on any challenge. Engineered for easy, secure installation; providing added protection for lights, bodywork and suspension.



#### REAR BUMPERS

NOT SHOWN

##### SPORT

» 2884345 • \$309<sup>99</sup>  
POLARIS GENERAL XP 1000/4 '20-21  
POLARIS GENERAL 1000/4 '16-21

#### HMW A-ARM GUARDS

NOT SHOWN

##### FRONT

» 2880274 • \$269<sup>99</sup>  
POLARIS GENERAL XP 1000/4 '20-21  
POLARIS GENERAL 1000/4 '16-21

#### FENDER FLARES

##### XL TOP SELLER

» 2884220 • \$269<sup>99</sup>  
POLARIS GENERAL 1000/4 '16-21  
Not compatible with Low Profile Rock Sliders  
Standard on GENERAL XP models

#### HIGH CLEARANCE A-ARM GUARDS

##### FRONT

» 2884221 • \$269<sup>99</sup>  
POLARIS GENERAL XP 1000/4 '20-21

#### FRONT BUMPERS

##### A SPORT LOW PROFILE

» 2881094 • \$339<sup>99</sup>  
POLARIS GENERAL XP 1000/4 '20-21  
POLARIS GENERAL 1000/4 '16-21

#### ROCK SLIDERS

NOT SHOWN

##### REAR

##### LOW PROFILE

» 2881102 • \$379<sup>99</sup>  
POLARIS GENERAL 1000 '16-21  
Not compatible with XL Fender Flares

» 2880171 • \$269<sup>99</sup>  
POLARIS GENERAL 1000 '16-21

##### EXTREME KICK-OUT

» 2-SEAT • 2881101 • \$409<sup>99</sup>  
POLARIS GENERAL XP 1000 '20-21  
POLARIS GENERAL 1000 '16-21  
» 4-SEAT • 2881992 • \$669<sup>99</sup>  
POLARIS GENERAL XP 4 1000 '20-21  
POLARIS GENERAL 4 1000 '17-21

#### EXPANSION ANCHOR MOUNTS

TOUGH EXPANSION ANCHOR MOUNTS DESIGNED FOR POLARIS GENERAL ALLOW FOR QUICK INSTALL OF ROCK SLIDERS AND BUMPERS WITHOUT DAMAGING THE VEHICLE'S FRAME.





# STORAGE



**NEW**  
LOCK & RIDE  
FALL AVAILABILITY  
REAR BED  
STORAGE RACK

» 2885113 • \$1,289<sup>99</sup>  
POLARIS GENERAL XP 1000/4 '20-21  
POLARIS GENERAL 1000/4 '16-21  
See P. 18 for more info



**CARGO  
BED MAT**  
» 2881933 • \$169<sup>99</sup>  
POLARIS GENERAL XP 1000/4 '20-21  
POLARIS GENERAL 1000/4 '16-21

**LOCK & RIDE  
TIP-DOWN  
HEADACHE RACK**  
» 2882144 • \$469<sup>99</sup>  
POLARIS GENERAL XP 1000/4 '20-21  
POLARIS GENERAL 1000/4 '16-21

**LOCK & RIDE  
BED EXTENDER**

» 2881547 • \$339<sup>99</sup>  
POLARIS GENERAL XP 1000/4 '20-21  
POLARIS GENERAL 1000/4 '16-21

**NEW**  
LOCK & RIDE  
FALL AVAILABILITY  
KOLPIN STRONGHOLD  
MOUNT - REAR BED  
STORAGE RACK

» 2885114 • \$83<sup>99</sup>  
POLARIS GENERAL XP 1000/4 '20-21  
POLARIS GENERAL 1000/4 '16-21  
See P. 18 for more info



Ample storage with  
multiple openings for  
ease & convenience

## POLARIS ENGINEERED ADVANTAGES



**LOCK & RIDE**  
REVOLUTIONARY  
INSTALLATION



**LOCK & RIDE  
CARGO BOX**

» 2881527 • \$409<sup>99</sup>  
POLARIS GENERAL XP 1000/4 '20-21  
POLARIS GENERAL 1000/4 '16-21  
Includes all mounting hardware for secure installation

**LOCK & RIDE  
D-RINGS**

» 2881545 • \$43<sup>99</sup>  
POLARIS GENERAL XP 1000/4 '20-21  
POLARIS GENERAL 1000/4 '16-21



**NOT SHOWN FIRE  
EXTINGUISHER HOLDER**

» 2882158 • \$114<sup>99</sup>  
POLARIS GENERAL XP 1000/4 '20-21  
POLARIS GENERAL 1000/4 '16-21  
Fits most 3.25" fire extinguishers (not included)



**LOCK & RIDE  
SPARE TIRE CARRIER**

» 2881529 • \$269<sup>99</sup>  
POLARIS GENERAL XP 1000/4 '20-21  
POLARIS GENERAL 1000/4 '16-21  
FITS WHEEL UP TO 30"



**BEHIND SEAT  
STORAGE BAG**

» 2882164 • \$94<sup>99</sup>  
POLARIS GENERAL XP 1000/4 '20-21  
POLARIS GENERAL 1000/4 '16-21



**IN-DASH  
STORAGE BAG**

» 2882165 • \$64<sup>99</sup>  
POLARIS GENERAL XP 1000/4 '20-21  
POLARIS GENERAL 1000/4 '16-21



**EASILY  
RECONFIGURE  
FOR ANY TASK  
OR ANY TRAIL**



# CAB COMFORT



## 8-VENT HEATER & DEFROST SYSTEM TOP SELLER



» 2881316 • \$1,289<sup>99</sup>

POLARIS GENERAL XP 1000/4 '20-21  
POLARIS GENERAL 1000/4 '16-21

Not Compatible with Rockford Fosgate® Stage 4 Audio Kits

Audio Bracket (2885112) required to install heater on vehicles with Ride Command and audio, sold separately

## WINDSHIELD WIPER & WASHER SYSTEM TOP SELLER



» 2881090 • \$739<sup>99</sup>

POLARIS GENERAL XP 1000/4 '20-21  
POLARIS GENERAL 1000/4 '16-21

See P. 08  
for windshields



## CONVEX REAR VIEW MIRROR

» 2881540 • \$124<sup>99</sup>

POLARIS GENERAL XP 1000/4 '20-21  
POLARIS GENERAL 1000/4 '16-21



## FLOOR MATS

» 2881934 • \$169<sup>99</sup>

POLARIS GENERAL XP 1000/4 '20-21  
POLARIS GENERAL 1000/4 '16-21

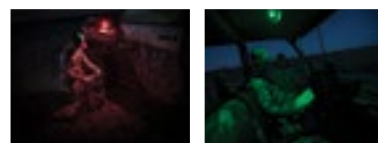

- Red light is great for reading maps
- Green light is perfect for navigating in the dark
- Blue light is ideal for night riding

## MULTI-FUNCTION CAB LIGHT



- LED dome light provides white, red, green and blue lighting options
- Battery-operated, recharges when vehicle is on
- Remove to use as flashlight in and around vehicle

» 2884047 • \$134<sup>99</sup>

POLARIS GENERAL XP 1000/4 '20-21  
POLARIS GENERAL 1000/4 '19-21

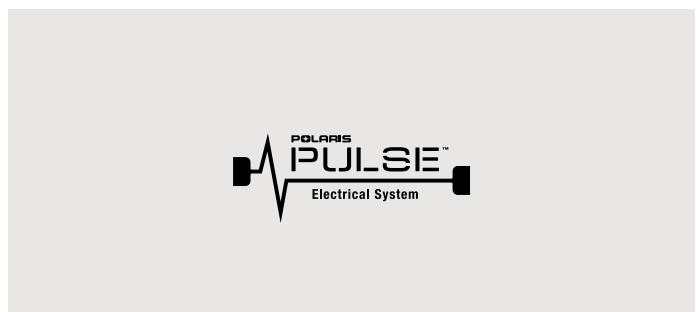

## POLARIS PULSE LED LIGHT BAR HARNESS



- Required to easily add electric components

» 2883785 • \$114<sup>99</sup>

POLARIS GENERAL XP 1000/4 '20-21  
POLARIS GENERAL 1000/4 '19-21

## POLARIS ENGINEERED ADVANTAGES



## ELECTRICAL INSTALLS MADE EASY WITH **PLUG & PLAY**

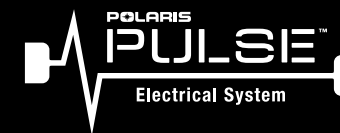

Look for to identify Polaris PULSE ready accessories.

- To install accessories, simply plug the harness into the Polaris PULSE hub
- No need to remove nuts and stack wire terminals like a three-post terminal setup
- By plugging in your accessories, a secure connection is guaranteed every time



ACCESSORIES

WINDSHIELDS & REAR PANELS

DOORS

ROOFS & PROTECTION

STORAGE, CAB COMFORT & HUNT

COOLERS

RIDE COMMAND & AUDIO

LIGHTING

WHEELS & TIRES

WINCHES & PLOWNS

# HUNT

**KOLPIN**  
OUTDOORS

**PROTECTING  
YOUR  
ESSENTIAL  
GEAR SINCE  
1943**



**STORAGE**



**NEW**  
LOCK & RIDE **FALL AVAILABILITY**  
**REAR BED  
STORAGE RACK**

- Take more gear with 2 Kolpin Stronghold XL mounts and integrated MOLLE panels
- 30 or 60 Qt. Polaris Coolers will still fit in bed with rack installed

» 2885113 • **\$1,289<sup>99</sup>**  
POLARIS GENERAL XP 1000/4 '20-21  
POLARIS GENERAL 1000/4 '16-21

**NEW**  
LOCK & RIDE **FALL AVAILABILITY**  
**KOLPIN STRONGHOLD MOUNT  
- REAR BED STORAGE RACK**

- Kolpin Stronghold mount for attaching gun boots or other Kolpin Stronghold items to a General Rear Rack

» 2885114 • **\$83<sup>99</sup>**  
POLARIS GENERAL XP 1000/4 '20-21  
POLARIS GENERAL 1000/4 '16-21

**KOLPIN STRONGHOLD CASES**

**KOLPIN STRONGHOLD GUN BOOTS**

- » XL TRANSPORT • 2882430\* • **\$129<sup>99</sup>**  
POLARIS GENERAL XP 1000/4 '20-21  
POLARIS GENERAL 1000/4 '16-21
- » L IMPACT • 2882426\* • **\$83<sup>99</sup>**  
POLARIS GENERAL XP 1000/4 '20-21  
POLARIS GENERAL 1000/4 '16-21

**KOLPIN STRONGHOLD AUTO-LATCH MOUNT**

» 2884106 • **\$83<sup>99</sup>**  
POLARIS GENERAL XP 1000/4 '20-21  
POLARIS GENERAL 1000/4 '16-21

**KOLPIN STRONGHOLD POP-UP BLIND/ICE AUGER BOOT**

» 2882427\* • **\$109<sup>99</sup>**  
POLARIS GENERAL XP 1000/4 '20-21  
POLARIS GENERAL 1000/4 '16-21

\*REQUIRES AUTO-LATCH MOUNT (2883970 OR 2884106)

**KOLPIN RHINO GRIPS** IDEAL FOR BOWS & UNCASSED GUNS

**LOCK & RIDE**  
**RHINO GRIP PRO**

» 2884107 • **\$109<sup>99</sup>**  
POLARIS GENERAL XP 1000/4 '20-21  
POLARIS GENERAL 1000/4 '16-21

**LOCK & RIDE**  
**RATCHETING RHINO GRIP**

» 2881575 • **\$90<sup>99</sup>**  
POLARIS GENERAL XP 1000/4 '20-21  
POLARIS GENERAL 1000/4 '16-21

**LOCK & RIDE**  
**RHINO GRIP XLR**

» 2881574 • **SINGLE • \$55<sup>99</sup>**  
POLARIS GENERAL XP 1000/4 '20-21  
POLARIS GENERAL 1000/4 '16-21

**LOCK & RIDE**  
**RHINO GRIP XLR - DOUBLES**

» 2884108 • **\$94<sup>99</sup>**  
POLARIS GENERAL XP 1000/4 '20-21  
POLARIS GENERAL 1000/4 '16-21

**NEW**  
**HEAVY-DUTY XLR REPLACEMENT RUBBER STRAPS (2)**

» 2889204 • **\$11<sup>99</sup>**  
POLARIS GENERAL XP 1000/4 '20-21,  
POLARIS GENERAL 1000/4 '16-21

**RHINO GRIP PRO RUBBER STRAPS**

» 2884109 • **\$11<sup>99</sup>**  
POLARIS GENERAL XP 1000/4 '20-21,  
POLARIS GENERAL 1000/4 '16-21

ACCESSORIES  
WINDSHIELDS & REAR PANELS  
DOORS  
ROOFS & PROTECTION  
STORAGE, CAB COMFORT & HUNT  
COOLERS  
RIDE COMMAND & AUDIO  
LIGHTING  
WHEELS & TIRES  
WINCHES & PULPUS

**KEEP IT  
ICE COLD**



**GRIZZLY TESTED.  
POLARIS APPROVED.**



This cooler is IGBC-approved, meaning it withstands the power expended by a typical grizzly bear if it was trying to get inside.

Seriously, there are experts who know what a grizzly is capable of doing, and they certify our coolers can take it.



**30, 60 & 105  
QUART FEATURES**



ComfortCarry  
Handles



TravelLock  
System



EasyOut  
Drain System



NoSlip  
Rubber Feet



PolarWall  
Insulation



IceLock  
Seal

**POLARIS NORTHSTAR COOLERS CAN SURVIVE JUST ABOUT ANYTHING -  
FROM EXTREME HEAT TO A NASTY TUMBLE OFF A VEHICLE.**



**105 QUART**

- » GRAPHITE • 2883426 • **\$509<sup>99</sup>**
- » DESERT • 2883392 • **\$509<sup>99</sup>**



**60 QUART**

- » GRAPHITE • 2883425 • **\$409<sup>99</sup>**
- » DESERT • 2881259 • **\$409<sup>99</sup>**



**30 QUART**

- » GRAPHITE • 2883424 • **\$309<sup>99</sup>**
- » DESERT • 2881315 • **\$309<sup>99</sup>**



**15 QUART**

- » GRAPHITE • 2883968 • **\$249<sup>99</sup>**











**20 QUART SOFTSIDE**

- » GRAPHITE • 2883390 • **\$209<sup>99</sup>**

**HOLDS ICE  
30+  
HOURS  
LONGER  
THAN YETI\***

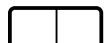
\*YETI is a registered trademark of YETI COOLERS, LLC

**ESSENTIAL ACCESSORIES SO YOUR COOLER WORKS AS HARD AS YOU DO**

COOLER ACCESSORIES	105 QUART	60 QUART	30 QUART	DON'T FORGET THESE ACCESSORIES		
 <p><b>WIRE BASKET</b></p>	2883648 • <b>\$59<sup>99</sup></b>	2882185 • <b>\$43<sup>99</sup></b>	2882438 • <b>\$36<sup>99</sup></b>	 <p><b>TUMBLERS</b></p> <ul style="list-style-type: none"> <li>» 30 OZ • 2883394 • <b>\$36<sup>99</sup></b></li> <li>» 20 OZ • 2883393 • <b>\$30<sup>99</sup></b></li> </ul>	 <p><b>LOCK &amp; RIDE QUICKSTRAP</b></p> <ul style="list-style-type: none"> <li>» 2882187 • <b>\$59<sup>99</sup></b></li> </ul> <p>ALL COOLERS AND POLARIS GENERAL CARGO BOXES</p>	 <p><b>BOTTLE OPENER</b></p> <ul style="list-style-type: none"> <li>» 2882183 • <b>\$15<sup>99</sup></b></li> </ul> <p>ALL COOLERS</p>
 <p><b>DIVIDERS</b> Doubles as cutting board</p>	2883468 • <b>\$43<sup>99</sup></b> COMES WITH ONE DIVIDER  1 way to partition	2882184 • <b>\$59<sup>99</sup></b> COMES WITH TWO DIVIDERS  2 ways to partition	2882186 • <b>\$30<sup>99</sup></b> COMES WITH ONE DIVIDER  1 way to partition			
 <p><b>SEAT CUSHION</b></p>	NOT AVAILABLE	2882179 • <b>\$114<sup>99</sup></b>	2882507 • <b>\$89<sup>99</sup></b>			
 <p><b>WHEELS</b></p>	2883967 • <b>\$119<sup>99</sup></b>	2882180 • <b>\$124<sup>99</sup></b>	NOT AVAILABLE			

# RIDECOMMAND

- **BUILT-IN GPS WITH TOPOGRAPHY MAPS TO SEE YOUR LOCATION AND PLAN YOUR RIDE**
- **MEDIA PLAYER WITH BUILT IN AM/FM TUNER FOR ALL YOUR FAVORITE MUSIC**
- **GROUP RIDE FOR BUDDY TRACKING, TO SEE YOUR FRIENDS ON THE MAP, TRACK AND SHARE RIDE STATS ON THE DISPLAY OR RIDE COMMAND MOBILE APP**

## REVOLUTIONIZING THE OFF-ROAD EXPERIENCE

### RIDE COMMAND 7" DISPLAY

- 7" High Bright Touchscreen visible in all conditions
- Displays critical vehicle information for fuel level, coolant temp and battery voltage
- Media player with built in AM/FM tuner
- Enhanced Group Ride capability to track and share your ride
- Dedicated shortcut buttons for quick access to features
- Bluetooth\* and USB smart phone connectivity
- Front camera support for better visibility on and off trail

» 2884072 • **\$1,999<sup>99</sup>**  
 POLARIS GENERAL XP 1000/4 '20-21  
 POLARIS GENERAL 1000/4 '19-21

### RIDE COMMAND MOUNT KIT

- Mount Ride Command seamlessly into the dash for perfect fit and finish
- Comes with wiring harnesses needed and accessory components
- Includes front and rear camera, V2V, and GPS antenna

» 2884283 • **\$649<sup>99</sup>**  
 POLARIS GENERAL XP 1000/4 '20-21  
 POLARIS GENERAL 1000/4 '20-21

### NEW AUDIO BRACKET

- Used to mount audio amplifier for front and rear speakers when subwoofer is removed
- Required to install a heater on a vehicle with Ride Command and audio

» 2885112 • **\$47<sup>99</sup>**  
 POLARIS GENERAL XP 1000/4 '20-21  
 POLARIS GENERAL 1000/4 '20-21

VISIT [POLARIS.COM/SHOPGENERAL](http://POLARIS.COM/SHOPGENERAL) TO VERIFY FITMENT FOR YOUR SPECIFIC MODEL & YEAR.

DOWNLOAD THE RIDE COMMAND MOBILE APP



CHECK FOR FEATURE ENHANCEMENTS & UPDATES AT [POLARIS.COM/RIDECOMMAND](http://POLARIS.COM/RIDECOMMAND)

# AUDIO



- PLUG AND PLAY
- ELEMENT READY\*
- NO LOSS OF CARGO SPACE
- BLUETOOTH\* CAPABLE

An industry first. A true factory installed integrated off-road audio system. Rockford Fosgate\* partnered with Polaris to purpose build the highest performing system specifically for the GENERAL platform. Tuned and rider-centric to create a class leading audio experience that is second to none.



### STAGE 1 AUDIO KIT

- PMX-P2 HEAD UNIT & FRONT COAXIAL SPEAKERS
- 2.7" full color display with AM/FM/WB tuner, Pandora\* Control and Bluetooth\* Connectivity
- 50 Watt 6.5" front coaxial speakers with enclosures and grilles

» 2884282 • **\$1,034<sup>99</sup>**  
 POLARIS GENERAL XP 1000/4 '20-21  
 POLARIS GENERAL 1000/4 '20-21



### NEW STAGE 2 PMX AUDIO KIT + REAR SPEAKERS

- REAR COAXIAL SPEAKERS & AMP
- 2, 50 Watt 6.5" rear coaxial speakers with enclosures and grilles
- 400 Watt 4-channel full range amplifier
- IP67 Rating delivering water resistance and dust protection

» 2885162 • **\$899<sup>99</sup>**  
 POLARIS GENERAL XP 1000/4 '20-21  
 POLARIS GENERAL 1000/4 '16-21



### NEW STAGE 2 RIDE COMMAND AUDIO KIT + REAR SPEAKERS

- FRONT & REAR COAXIAL SPEAKERS & AMP
- 2, 50 Watt 6.5" front and rear coaxial speakers with enclosures and grilles
- 400 Watt 4-channel full range amplifier
- IP67 Rating delivering water resistance and dust protection

» 2885163 • **\$969<sup>99</sup>**  
 POLARIS GENERAL XP 1000/4 '20-21  
 POLARIS GENERAL 1000/4 '16-21  
 REQUIRES RIDE COMMAND 7" DISPLAY 2884072 & MOUNT KIT 2884283 (BOTH SOLD SEPARATELY)



### NEW STAGE 4 UPGRADE

- SUBWOOFER
- Compatible with Stage 1 and Stage 2 PMX-P2 Audio Kits
- 200 Watt 10" subwoofer

» 2889053 • **\$589<sup>99</sup>**  
 POLARIS GENERAL XP 1000/4 '20-21  
 POLARIS GENERAL 1000/4 '16-21

## BUILD YOUR SOUND

	HEAD UNIT: PMX-P2	RIDE COMMAND
AUDIO:	STAGE 1 AUDIO KIT	STAGE 4 RIDE COMMAND AUDIO KIT
MODEL FITMENT:	<p><b>XP</b></p> <p><b>DELUXE</b></p> <p><b>PREMIUM</b></p> <p><b>SPORT</b></p>	<p><b>STAGE 2 + 4 UPGRADES</b></p>
	<p><b>FACTORY INSTALLED STOCK AUDIO</b></p> <p><b>STAGE 1 AUDIO KIT WITH PMX-P2 HEAD UNIT</b></p> <p>2884282 • <b>\$1,034<sup>99</sup></b></p>	<p><b>RIDE COMMAND + STAGE 4 AUDIO SYSTEM UPGRADE PACKAGE INSTALLED</b></p> <p>TO ADD 8-VENT HEATER &amp; DEFROST SYSTEM (2881316), SUBWOOFER MUST BE REMOVED AND AMP RELOCATION BRACKET (2885112) MUST BE INSTALLED</p>
	<p><b>STAGE 2 + REAR SPEAKERS UPGRADE</b></p> <p>REAR SPEAKERS, AMP + AUDIO BRACKET</p> <p>2885162 • <b>\$899<sup>99</sup></b></p> <p><b>OPTIONAL SUBWOOFER</b></p> <p><b>STAGE 4 UPGRADE SUBWOOFER</b></p> <p>2889053 • <b>\$589<sup>99</sup></b></p> <p>NOT COMPATIBLE WITH 8-VENT HEATER &amp; DEFROST SYSTEM (2881316)</p>	<p><b>RIDE COMMAND MOUNT KIT</b></p> <p>2884072 • <b>\$1,999<sup>99</sup></b></p> <p>2884283 • <b>\$649<sup>99</sup></b></p> <p>2020-2021 MODELS</p> <p><b>STAGE 2 UPGRADE REAR SPEAKERS, AMP + AUDIO BRACKET</b></p> <p>2885163 • <b>\$969<sup>99</sup></b></p> <p><b>STAGE 4 UPGRADE SUBWOOFER</b></p> <p>2889053 • <b>\$589<sup>99</sup></b></p> <p>NOT COMPATIBLE WITH 8-VENT HEATER &amp; DEFROST SYSTEM (2881316)</p>



## KNOW YOUR TERRAIN



- Tread patterns optimized for extreme traction
- Ideal for both hard pack and loose trail



- Flexible "grippy" tread
- Aggressive side bite



- Provides traction and durability
- Built to perform in hard sand, jagged rocks or any other extreme terrain



- Extra deep treads
- Self-cleaning lugs



- Paddles provide traction and durability in soft sand
- Built to float on top of sand



- Industry leading anti-puncture side walls
- Purpose-built, long lasting tread patterns



- Handles extreme cold
- Holds shape and provides traction

# SUPERIOR PERFORMANCE & DURABILITY

# WAYS TO SHOP WHEELS & TIRES



## LIFELONG PERFORMANCE

- Every tire is designed and constructed with longevity in mind
- 3,000+ mile rated (4,828 kilometers)

## PREMIUM PROTECTION

- Pro Armor makes tires with extra protection exactly where it's needed most—the sidewall
- Triple-belted sidewalls keep your tires more resistant so you can keep going

## TOUGHEST TIRES

- Higher ply ratings mean added protection
- Pro Armor builds 8 or 10-ply rated tires for higher puncture-resistance



## KNOW YOUR TIRES

DIMENSIONS			TREAD DEPTH	TIRE WEIGHT	PLY RATING	SIDEWALL BELTS	LOAD RATING
TIRE HEIGHT	TIRE WIDTH	WHEEL DIAMETER					
<b>32" x 9"</b>	<b>R15</b>	<b>FRONT/REAR</b>	<b>30 mm</b>	<b>41 lbs</b>	<b>10</b>	<b>3</b>	<b>1,320 lbs</b>
Part Number • Price							
<b>USAGE</b> Where can you use the tire			<b>TREAD DEPTH</b> Deeper treads have more grip in all conditions	<b>TIRE WEIGHT</b> A lighter tire makes for improved vehicle performance	<b>PLY RATING</b> Indicates tire puncture-resistance	<b>SIDEWALL BELTS</b> Increase your resistance to sidewall punctures	<b>LOAD RATING</b> How much weight can the tire handle

## TIRES BY SIZE

27"	28"	29"	30"
MUD XC	HARVESTER	DUAL-THREAT	CRAWLER XG
HARVESTER	CRAWLER XR	MUD XC	ATTACK 2.0
	ATTACK 2.0	HD-K	HARVESTER
	CRAWLER XG		CRAWLER XG

## TIRES BY TERRAIN

TRAIL	ROCK	DESERT	MUD	UTILITY	SNOW
CRAWLER XR	CRAWLER XR	CRAWLER XR	MUD XC	HARVESTER	ATTACK 2.0
CRAWLER XG	CRAWLER XG	CRAWLER XG		PRESERVE	ATTACK
MUD XC	DUAL-THREAT	ATTACK 2.0		XD-K	HARVESTER
ATTACK 2.0	ATTACK 2.0	ATTACK		HD-K	XD-K
ATTACK		DUAL-THREAT			HD-K
DUAL-THREAT					
HARVESTER					
PRESERVE					
XD-K					
HD-K					

## WHEELS BY SIZE

14"	15"
40-SERIES (7 TIRE OPTIONS)	50-SERIES (6 TIRE OPTIONS)
4201 (AMPLIFY)	5201 (CYCLONE)
4202 (BUCKLE)	5202 (FLARE)
4301 (COMBAT)	5301 (HALO)
4203 (REBLR)	5203 (HEXLR)
4204 (SHACKLE)	5204 (WYDE)
4205 (SIXR)	
HD DUAL BEADLOCK	

## KNOW YOUR WHEELS

### STEP 1: SELECT YOUR SERIES

4 = 40-SERIES 5 = 50-SERIES

### STEP 2: CHOOSE YOUR LOAD RATING

1 = <800 LBS 2 = 801 - 1,300 LBS 3 = 1,301 - 1,600+ LBS

### STEP 3: PICK YOUR STYLE

OFFSET / BEADLOCK / COLOR

INCREASE OFFSET FROM STOCK = NARROWER STANCE  
DECREASE OFFSET FROM STOCK = WIDER STANCE

# TIRES



## PRO ARMOR CRAWLER XR

- Wanna race? This tire grips it all from the trail to the rocks
- Square block profile for even surface contact
- A tougher durometer than the XG to take on the toughest the trail has to offer

	TREAD DEPTH	TIRE WEIGHT	PLY RATING	SIDEWALL BELTS	LOAD RATING
14" <b>28" x 10" R14</b> 5415536 • \$259 <sup>99</sup>	FRONT/REAR 16 mm	32 lbs	8	3	1,140 lbs



### XR

#### SINGLE DUROMETER

- Smaller lug height, added rigidity and lateral stability when cornering
- Unique lug design excels in hard-packed, fast terrain



## PRO ARMOR ATTACK 2.0

- Engineered for excellent hard-pack performance
- Dual-compound technology and radial construction offer performance in all terrains
- Tight thread pattern for a quieter ride

	TREAD DEPTH	TIRE WEIGHT	PLY RATING	SIDEWALL BELTS	LOAD RATING
15" <b>28" x 10" R15</b> 5416344 • \$269 <sup>99</sup>	FRONT/REAR 25 mm	32 lbs	10	3	1,110 lbs
16" <b>30" x 10" R15</b> 5416345 • \$299 <sup>99</sup>		38 lbs			1,235 lbs



**TIGHTER TREAD PATTERN =**  
Better traction in hard pack

**DUAL-DUROMETER LUG =**  
Increased grip & traction in rough terrain, smoother

**10-PLY RATED =**  
Increased durability

**LARGER SIZE OFFERING IN 28" =**  
More ground clearance & trail traction



## PRO ARMOR CRAWLER XG

- Big or small, these tires crawl them all
- A soft, sticky compound makes this tire ideal for both rock crawling and desert running
- 8-ply, triple-belted ballistic sidewalls resist punctures

	TREAD DEPTH	TIRE WEIGHT	PLY RATING	SIDEWALL BELTS	LOAD RATING
14" <b>30" x 10" R14</b> 5415616 • \$299 <sup>99</sup>	FRONT/REAR 20 mm	38 lbs	8	3	1,280 lbs
16" <b>28" x 10" R15</b> 5416346 • \$269 <sup>99</sup>		33 lbs			1,100 lbs
16" <b>30" x 10" R15</b> 5416397 • \$299 <sup>99</sup>		39 lbs			1,280 lbs



### WHAT CRAWLER ARE YOU?

### XG

#### DUAL-DUROMETER

- Taller lug height
- Perfect balance between high-speed performance, durability and flex in order to grip slick rock



## PRO ARMOR ATTACK

- The best all-purpose tire for all-season traction in any terrain
- Unique, full-face tread design
- Harder durometer lugs promote extended wear, increasing tire life
- Wider spaced lugs provide more grip in softer terrain

	TREAD DEPTH	TIRE WEIGHT	PLY RATING	SIDEWALL BELTS	LOAD RATING
14" <b>26" x 9" R14</b> 5415613 • \$189 <sup>99</sup>	FRONT	28 lbs	8	3	910 lbs
14" <b>26" x 11" R14</b> 5415614 • \$209 <sup>99</sup>	REAR	32 lbs			1,320 lbs



## PRO ARMOR DUAL-THREAT

- Dual-compound technology and radial construction offer performance in all terrains
- Softer durometer rubber on outer edge for overall superior grip and feel
- Harder durometer rubber in the middle for increased traction during acceleration and longer tread life

	TREAD DEPTH	TIRE WEIGHT	PLY RATING	SIDEWALL BELTS	LOAD RATING
14" <b>26" x 9" R14</b> 5416340 • \$219 <sup>99</sup>	FRONT/REAR 16 mm	27 lbs	10	3	910 lbs
14" <b>26" x 11" R14</b> 5416341 • \$229 <sup>99</sup>		30 lbs			1,110 lbs
14" <b>29" x 9" R14</b> 5416342 • \$269 <sup>99</sup>		30 lbs			1,110 lbs
14" <b>29" x 11" R14</b> 5416343 • \$279 <sup>99</sup>		35 lbs			1,320 lbs



### DUAL-COMPOUND = MORE GRIP + LONGER LIFE

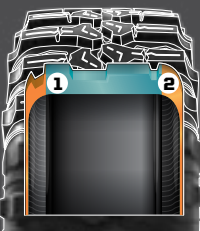

- 1 Firmer Durometer Rubber = Longer Life
- 2 Softer Durometer Rubber = More Grip



## PRO ARMOR MUD XC

- Designed for the perfect mud-trail crossover for a smooth ride on the trail and aggressive traction in the mud
- Dual-compound technology with harder durometer lugs promote extended wear, increasing tire life
- 10-ply construction, means added protection in the toughest terrain

	TREAD DEPTH	TIRE WEIGHT	PLY RATING	SIDEWALL BELTS	LOAD RATING
14" <b>29" x 10" R14</b> 5416946 • \$269 <sup>99</sup>	FRONT/REAR	39 lbs	10	3	1,390 lbs
14" <b>27" x 9" R14</b> 5416947 • \$249 <sup>99</sup>	FRONT	30 lbs			1,170 lbs
14" <b>27" x 11" R14</b> 5416948 • \$259 <sup>99</sup>	REAR	32 lbs			1,320 lbs



ACCESSORIES

WINDSHIELDS & REAR PANELS

DOORS

ROOFS & PROTECTION

STORAGE CAB COMFORT & HUNT

COOLERS

RIDE COMMAND & AUDIO

LIGHTING

WHEELS & TIRES

WINCHES & PULPS



# TIRES

## PICKING THE RIGHT UTILITY TIRE

UTILITY FEATURE	HARVESTER	PRESERVE	XD-K	HD-K
<b>5,000 Mile / 8,047 Kilometer Rated</b> Long life and performance	X	X		
<b>10-Ply Rated</b> Higher ply ratings means added protection	X	X	X	X
<b>Low Impact Tread</b> Easy on soil		X		
<b>Heavy Duty Tread</b> Aggressive tread pattern for all day work on farms or ranches	X		X	X
<b>Turf-Friendly</b> Easy on grass and farm yard	X	X		
<b>Aramid Fiber Belt</b> 5x times stronger than steel and lighter			X	X
<b>Wide Range of Sizes</b> For exactly how you want to use your machine	30", 28", 27", 26"	27", 26"	26"	29"



### PRO ARMOR PRESERVE

- Turf-friendly for areas where low-impact from tire tread is needed
- Rounded profile and special tread pattern to limit footprint

	TREAD DEPTH	TIRE WEIGHT	PLY RATING	SIDEWALL BELTS	LOAD RATING
12" 26" x 8" R12 5416403 • \$229 <sup>99</sup>	FRONT	24 lbs			855 lbs
12" 26" x 10" R12 5416402 • \$249 <sup>99</sup>	REAR	28 lbs	10	3	1,320 lbs
14" 27" x 10" R14 5416348 • \$249 <sup>99</sup>	FRONT/REAR	29 lbs			1,320 lbs



### PRO ARMOR HARVESTER

- All-around work horse with tread life of 5,000 miles / 8047 km
- Tread pattern designed to withstand anything from the farmyard to the pastures and the trail
- With 10-ply, it can carry the load day in and day out

	TREAD DEPTH	TIRE WEIGHT	PLY RATING	SIDEWALL BELTS	LOAD RATING
12" 26" x 8" R12 5416396 • \$229 <sup>99</sup>	FRONT	24 lbs			855 lbs
12" 26" x 10" R12 5415966 • \$249 <sup>99</sup>	REAR	32 lbs			1,355 lbs
14" 27" x 10" R14 5415965 • \$249 <sup>99</sup>	FRONT/REAR	32 lbs	10	3	1,320 lbs
14" 28" x 10" R14 5416347 • \$269 <sup>99</sup>	FRONT/REAR	34 lbs			1,390 lbs
NEW 15" 30" x 10" R15 5417529 • \$299 <sup>99</sup>	FRONT/REAR	37 lbs			1,320 lbs



### PRO ARMOR XD-K

- 26" Aramid fiber-belted tire to tackle any terrain
- Unique full-face tread design
- Harder durometer lugs promotes extended wear, increasing tire life

	TREAD DEPTH	TIRE WEIGHT	PLY RATING	SIDEWALL BELTS	LOAD RATING
12" 26" x 9" R12 5415756 • \$247 <sup>99</sup>	FRONT	28 lbs			855 lbs
12" 26" x 11" R12 5415757 • \$260 <sup>99</sup>	REAR	32 lbs	10	3/1 Aramid	1,100 lbs



### PRO ARMOR HD-K

- Designed to provide a smooth ride and aggressive traction in all riding terrains
- Triple belted sidewall provides extreme sidewall protection and extends the tire life
- Quad belt tread core offers superior protection and longer tread life

	TREAD DEPTH	TIRE WEIGHT	PLY RATING	SIDEWALL BELTS	LOAD RATING
14" 29" x 10" R14 5417507 • \$329 <sup>99</sup>	FRONT/REAR	40 lbs	10	3/1 Aramid	1,320 lbs



# WHEELS



BEADLOCK INCLUDED



BEADLOCK REQUIRED

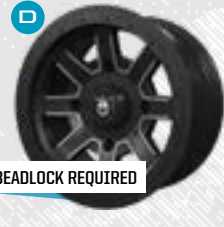

INNER AND OUTER BEADLOCK INCLUDED



BEADLOCK REQUIRED

14"

## 40-SERIES

### A 4201 (AMPLIFY) ○

FRONT WEIGHT: 13 lbs | LOAD RATING: 900 lbs | OFFSET: +4  
 REAR WEIGHT: 14 lbs | LOAD RATING: 1,300 lbs | OFFSET: -9  
 ACCENT: FRONT 14" x 7" 1522956-266 **\$189<sup>99</sup>**  
 REAR 14" x 8" 1522957-266 **\$209<sup>99</sup>**  
 MATTE BLACK: FRONT 14" x 7" 1522956-458 **\$169<sup>99</sup>**  
 REAR 14" x 8" 1522957-458 **\$179<sup>99</sup>**

### B 4202 (BUCKLE) ○

FRONT WEIGHT: 12.75 lbs | LOAD RATING: 900 lbs | OFFSET: +4  
 REAR WEIGHT: 13.5 lbs | LOAD RATING: 1,300 lbs | OFFSET: -9  
 ACCENT: FRONT 14" x 7" 1522544-266 **\$189<sup>99</sup>**  
 REAR 14" x 8" 1522545-266 **\$209<sup>99</sup>**  
 MATTE BLACK: FRONT 14" x 7" 1522544-458 **\$169<sup>99</sup>**  
 REAR 14" x 8" 1522545-458 **\$179<sup>99</sup>**

### C 4301 BEADLOCK (COMBAT) ○

FRONT/REAR WEIGHT: 16 lbs | LOAD RATING: 1,600 lbs | OFFSET: +38  
 ACCENT: FRONT/REAR 14" x 7" 1523284 **\$269<sup>99</sup>**  
 MATTE BLACK: FRONT/REAR 14" x 7" 1523283 **\$259<sup>99</sup>**

14" FORGED BEADLOCK RINGS  
Only used on 4203 (REBLR)

PART #	MSRP
Voodoo Blue	1522244-619 <b>\$114<sup>99</sup></b>
Machined	1522244-266 <b>\$114<sup>99</sup></b>
White	1522244-133 <b>\$114<sup>99</sup></b>
Indy Red	1522244-293 <b>\$114<sup>99</sup></b>
Orange Crush	1522244-589 <b>\$114<sup>99</sup></b>
Matte Black - Replacement <small>Only used on 5301 (HALO)</small>	1523146-458 <b>\$74<sup>99</sup></b>

15" FORGED BEADLOCK RINGS  
Only used on 5203 (HEXLR)

PART #	MSRP
Matte Black - Replacement	1523147-458 <b>\$79<sup>99</sup></b>

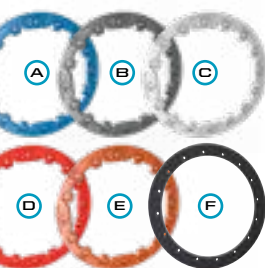

### NEW HD DUAL BEADLOCK

FRONT/REAR WEIGHT: 40 lbs | LOAD RATING: 1,600 lbs | OFFSET: +38  
 MATTE BLACK: FRONT/REAR 14" x 7" 1524022-458 **\$359<sup>99</sup>**

### D 4203 BEADLOCK (REBLR) ○

FRONT WEIGHT: 13 lbs | LOAD RATING: 900 lbs | OFFSET: +4  
 REAR WEIGHT: 14.5 lbs | LOAD RATING: 1,300 lbs | OFFSET: -9  
 MATTE BLACK: FRONT 14" x 7" 1522238-458 **\$279<sup>99</sup>**  
 REAR 14" x 8" 1522239-458 **\$279<sup>99</sup>**

### E 4204 (SHACKLE) ○

FRONT WEIGHT: 13 lbs | LOAD RATING: 900 lbs | OFFSET: +4  
 REAR WEIGHT: 14 lbs | LOAD RATING: 1,300 lbs | OFFSET: -9  
 ACCENT: FRONT 14" x 7" 1522546-266 **\$189<sup>99</sup>**  
 REAR 14" x 8" 1522547-266 **\$189<sup>99</sup>**  
 MATTE BLACK: FRONT 14" x 7" 1522546-458 **\$169<sup>99</sup>**  
 REAR 14" x 8" 1522547-458 **\$169<sup>99</sup>**

### F 4205 (SIXR) ○

FRONT WEIGHT: 10.5 lbs | LOAD RATING: 900 lbs | OFFSET: +4  
 REAR WEIGHT: 12.5 lbs | LOAD RATING: 1,300 lbs | OFFSET: -9  
 MATTE BLACK: FRONT 14" x 7" 1521507-521 **\$149<sup>99</sup>**  
 REAR 14" x 8" 1521508-521 **\$169<sup>99</sup>**  
 LUSTER: FRONT 14" x 7" 1521507-410 **\$189<sup>99</sup>**  
 REAR 14" x 8" 1521508-410 **\$199<sup>99</sup>**

15"

## 50-SERIES

### H 5201 (CYCLONE) ○

FRONT/REAR WEIGHT: 17.1 lbs | LOAD RATING: 1,300 lbs | OFFSET: +4  
 ACCENT: FRONT/REAR 15" x 7" 1523184-266 **\$179<sup>99</sup>**  
 MATTE BLACK: FRONT/REAR 15" x 7" 1523184-458 **\$149<sup>99</sup>**

### I 5301 BEADLOCK (HALO) ○

FRONT/REAR WEIGHT: 17 lbs | LOAD RATING: 1,600 lbs | OFFSET: +38  
 ACCENT: FRONT/REAR 15" x 7" 1523282 **\$299<sup>99</sup>**  
 MATTE BLACK: FRONT/REAR 15" x 7" 1523286 **\$269<sup>99</sup>**

### J 5204 (WYDE) ○

FRONT/REAR WEIGHT: 13.5 lbs | LOAD RATING: 1,300 lbs | OFFSET: +55  
 MATTE BLACK: FRONT/REAR 15" x 7" 1522550-458 **\$249<sup>99</sup>**

### K 5202 (FLARE) ○

FRONT/REAR WEIGHT: 17.8 lbs | LOAD RATING: 1,300 lbs | OFFSET: +4  
 ACCENT: FRONT/REAR 15" x 7" 1523102-266 **\$179<sup>99</sup>**  
 MATTE BLACK: FRONT/REAR 15" x 7" 1523102-458 **\$149<sup>99</sup>**

### L 5203 BEADLOCK (HEXLR) ○

FRONT/REAR WEIGHT: 16 lbs | LOAD RATING: 1,300 lbs | OFFSET: +38  
 MATTE BLACK: FRONT/REAR 15" x 7" 1522435-458 **\$309<sup>99</sup>**

○ LUG NUTS REQUIRED

## KNOW YOUR WHEELS

STEP 1: SELECT YOUR SERIES

4 = 40-SERIES 5 = 50-SERIES

STEP 2: CHOOSE YOUR LOAD RATING  
 1 = <800 LBS 2 = 801 - 1,300 LBS 3 = 1,301 - 1,600+ LBS

STEP 3: PICK YOUR STYLE  
 OFFSET / BEADLOCK / COLOR

INCREASE OFFSET FROM STOCK = NARROWER STANCE  
 DECREASE OFFSET FROM STOCK = WIDER STANCE

## KNOW YOUR TERRAIN



• Tread patterns optimized for extreme traction  
 • Ideal for both hard pack and loose trail



• Extra deep treads  
 • Self-cleaning lugs



• Industry leading anti-puncture side walls  
 • Purpose-built, long lasting tread patterns



• Flexible "grippy" tread  
 • Aggressive side bite

# WHEEL & TIRE SETS

14"  
40-SERIES

	TRAIL	MUD	UTILITY	ROCK
DUAL-THREAT 29" 3,000 Miles 4828 km	MUD XC 27" 3,000 Miles 4828 km	MUD XC 29" 3,000 Miles 4828 km	HARVESTER 27" 5,000 Miles 8047 km	HARVESTER 28" 5,000 Miles 8047 km
CRAWLER XG 30" 3,000 Miles 4828 km	CRAWLER XR 28" 3,000 Miles 4828 km			
4201 (AMPLIFY) Accent ○	2883146 \$1,859 <sup>99</sup>	2884272 \$1,739 <sup>99</sup>	2884265 \$1,849 <sup>99</sup>	2882388 \$1,739 <sup>99</sup>
4201 (AMPLIFY) Matte Black ○	2883147 \$1,739 <sup>99</sup>	2884273 \$1,612 <sup>49</sup>	2884266 \$1,715 <sup>99</sup>	2882389 \$1,599 <sup>99</sup>
4202 (BUCKLE) Accent ○	2883148 \$1,859 <sup>99</sup>	2884267 \$1,739 <sup>99</sup>	2884260 \$1,849 <sup>99</sup>	2882393 \$1,739 <sup>99</sup>
4202 (BUCKLE) Matte Black ○	2883149 \$1,739 <sup>99</sup>	2884268 \$1,612 <sup>49</sup>	2884261 \$1,715 <sup>99</sup>	2882394 \$1,599 <sup>99</sup>
4301 (COMBAT) Accent BEADLOCKS PRE-MOUNTED	2883219 \$2,269 <sup>99</sup>			2883220 \$1,859 <sup>99</sup>
4301 (COMBAT) Matte Black BEADLOCKS PRE-MOUNTED	2883218 \$2,139 <sup>99</sup>			2883221 \$1,739 <sup>99</sup>
4203 (REBLR) Matte Black BEADLOCKS SOLD SEPARATELY ○				2883211 \$2,399 <sup>99</sup>
4203 (REBLR) Matte Black BEADLOCKS SOLD SEPARATELY ○				2883210 \$2,269 <sup>99</sup>
4203 (REBLR) Matte Black BEADLOCKS SOLD SEPARATELY ○				2883212 \$1,999 <sup>99</sup>
4204 (SHACKLE) Accent ○	2883150 \$1,859 <sup>99</sup>	2884270 \$1,739 <sup>99</sup>	2884263 \$1,799 <sup>99</sup>	2882385 \$1,739 <sup>99</sup>
4204 (SHACKLE) Matte Black ○	2883151 \$1,739 <sup>99</sup>	2884271 \$1,612 <sup>49</sup>	2884264 \$1,679 <sup>99</sup>	2882386 \$1,599 <sup>99</sup>
4205 (SIXR) Luster ○				2883222 \$1,859 <sup>99</sup>
4205 (SIXR) Matte Black ○	2883152 \$1,739 <sup>99</sup>	2884269 \$1,599 <sup>99</sup>	2884262 \$1,679 <sup>99</sup>	2882387 \$1,599 <sup>99</sup>
				2883224 \$1,739 <sup>99</sup>
				2881558 \$1,999 <sup>99</sup>
				2881371 \$1,739 <sup>99</sup>
				2881564 \$1,999 <sup>99</sup>
				2881372 \$1,599 <sup>99</sup>
				2881559 \$1,859 <sup>99</sup>
				2881372 \$1,599 <sup>99</sup>

15"  
50-SERIES

	TRAIL	UTILITY	ROCK
ATTACK 2.0 28" 3,000 Miles 4828 km	ATTACK 2.0 30" 3,000 Miles 4828 km	HARVESTER 30" 5,000 Miles 8047 km	CRAWLER XG 28" 3,000 Miles 4828 km
CRAWLER XG 30" 3,000 Miles 4828 km			
5201 (CYCLONE) Accent ○	2883160 \$1,799 <sup>99</sup>	2883169 \$1,999 <sup>99</sup>	2883188 \$1,799 <sup>99</sup>
5201 (CYCLONE) Matte Black ○	2883159 \$1,669 <sup>99</sup>	2883168 \$1,859 <sup>99</sup>	2883179 \$2,059 <sup>99</sup>
5202 (FLARE) Accent ○	2883158 \$1,799 <sup>99</sup>	2883167 \$1,999 <sup>99</sup>	2885045 \$1,799 <sup>99</sup>
5202 (FLARE) Matte Black ○	2883157 \$1,669 <sup>99</sup>	2883166 \$1,859 <sup>99</sup>	2883186 \$1,799 <sup>99</sup>
5301 (HALO) Accent BEADLOCKS PRE-MOUNTED	2883162 \$2,169 <sup>99</sup>	2883171 \$2,399 <sup>99</sup>	2885046 \$1,669 <sup>99</sup>
5301 (HALO) Matte Black BEADLOCKS PRE-MOUNTED	2883161 \$2,059 <sup>99</sup>	2883170 \$2,269 <sup>99</sup>	2883185 \$1,669 <sup>99</sup>
5203 (HEXLR) Matte Black BEADLOCKS SOLD SEPARATELY	2883154 \$2,059 <sup>99</sup>	2883163 \$2,269 <sup>99</sup>	2885049 \$2,069 <sup>99</sup>
5204 (WYDE) Matte Black ○	2883155 \$1,669 <sup>99</sup>	2883164 \$1,859 <sup>99</sup>	2883182 \$2,059 <sup>99</sup>
			2883177 \$2,059 <sup>99</sup>
			2883176 \$1,939 <sup>99</sup>
			2883181 \$2,469 <sup>99</sup>
			2883189 \$2,059 <sup>99</sup>
			2883180 \$2,329 <sup>99</sup>
			2885051 \$1,799 <sup>99</sup>
			2883183 \$1,669 <sup>99</sup>
			2883174 \$1,939 <sup>99</sup>

○ LUG NUTS REQUIRED

## REPLACEMENT CAPS

### POLARIS

LUSTER	ALL WHEELS EXCEPT 5203 (HEXLR) & 5204 (WYDE)	1521509-410 \$15 <sup>99</sup>
MATTE BLACK		1521509-521 \$15 <sup>99</sup>
LUSTER	5203 (HEXLR)	1522243-410 \$30 <sup>99</sup>
MATTE BLACK		1522243-458 \$30 <sup>99</sup>
NEW HD MATTE BLACK	ALL WHEELS	5457498-458 \$29 <sup>99</sup>

### PRO ARMOR

LUSTER	ALL WHEELS EXCEPT 5203 (HEXLR) & 5204 (WYDE)	5453209-410 \$15 <sup>99</sup>
MATTE BLACK		5453209-458 \$15 <sup>99</sup>
MATTE BLACK	5204 (WYDE)	1523063-458 \$13 <sup>99</sup>
LUSTER	5203 (HEXLR)	1523015-410 \$15 <sup>99</sup>
MATTE BLACK		1523015-458 \$15 <sup>99</sup>

## 12mm x 1.5 SPLINED LUG NUTS

LUG NUTS REQUIRED	
16 SPLINED LUG NUTS WITH WRENCH ADAPTER	2879332 \$54 <sup>99</sup>
4 SPLINED LUG NUTS WITHOUT WRENCH	2879331 \$18 <sup>99</sup>
12mm x 1.5 SPLINED LUG WRENCH	2204966 \$12 <sup>99</sup>

### COLBY SHORT ULTIMATE VALVE (2 PACK)

» 2883292 • **\$38<sup>99</sup>**

### COLBY VALVE SHORT ULTIMATE VALVE (2 PACK)

» 2883293 • **\$38<sup>99</sup>**

### COLBY COMBO VALVE KIT (16 PACK)

• Includes 8 ultimate valves and 8 emergency valves

» 2883294 • **\$589<sup>99</sup>**

## 2 WAYS TO PURCHASE

INDIVIDUAL WHEELS & TIRES - OR - COMPLETE SETS AS LISTED

visit [Polaris.com/ProArmorGENERAL](http://Polaris.com/ProArmorGENERAL) TO BUILD YOUR CUSTOM SET & VERIFY FITMENT

Exclusively at Polaris Authorized Dealers or [Polaris.com/ProArmorGENERAL](http://Polaris.com/ProArmorGENERAL)

# WINCHES

TESTED **1,200+**  
PULLS AT MAX LOAD

OPERATES FULLY  
SUBMERGED

BUILT TO WITHSTAND  
**-20° F** TEMPERATURES

MILITARY  
TESTED & APPROVED



## FEATURES

**PRO** PRO HEAVY DUTY SERIES

**HD** HEAVY DUTY SERIES

ALL POLARIS ENGINEERED  
WINCHES COME WITH:



- ✓ FAST WIRE CONNECTION TO POLARIS PULSE SYSTEM
- ✓ HOOK WITH STRAP
- ✓ CUT STEEL GEARS & SEALED DRIVETRAIN
- ✓ SEALED PERMANENT MAGNET MOTOR

INDUSTRY **1<sup>ST</sup>**  
TECHNOLOGY

**RAPID ROPE RECOVERY** **5X**  
FASTER

1. Set Dial to FREE SPOOL (N) to attach Winch Hook
2. Set Dial to PULL (L) for Winch Mode
3. Set Dial to ROPE RECOVERY (H) for 5x Faster Rope Recovery



NOT AVAILABLE

**AUTO STOP TECHNOLOGY**

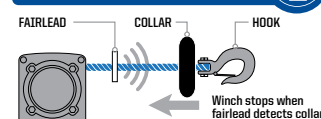

Stops winch at end of pull to prevent driveline stress and plow overlifting

WITH ALUMINUM FAIRLEAD

ADD AUTO STOP UPGRADE

2881288 • \$134<sup>99</sup>  
SYNTHETIC ROPE REQUIRED



WITH STEEL ROLLER FAIRLEAD

**PREMIUM SYNTHETIC ROPE**

- Lightweight & Easy to Handle
- Superior Flexibility & Strength
- 50 ft. Long



ADD SYNTHETIC ROPE

2879187 • \$179<sup>99</sup>



**WIRELESS REMOTE**

50 ft. range wireless remote control with unique code for interference-free operation



ADD WIRELESS REMOTE

2881287 • \$179<sup>99</sup>



MODEL	4,500 LB.	4,500 LB.
POLARIS GENERAL XP 1000/4 '20-21	<b>2883861</b>	<b>2883860</b>
POLARIS GENERAL 1000/4 '19-21	\$1,139 <sup>99</sup>	\$809 <sup>99</sup>

# PLOWS & TRACKS

**GLACIER PRO HD**  
PLOW SYSTEM

» 72" or 66" Blades

GLACIER PRO HD GIVES YOU

» Choice of poly or steel

» Manual angle system standard

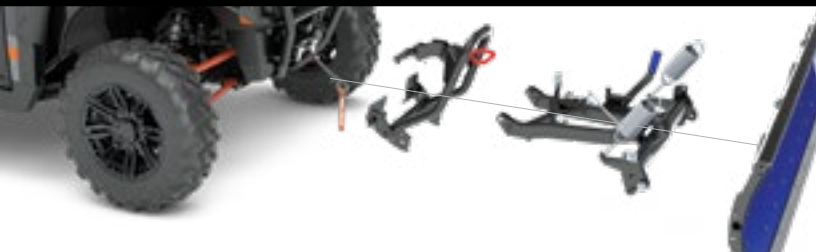

**66" POLY BLADE**  
BEST FOR CORROSION RESISTANCE



**72" STEEL BLADE**  
BEST FOR BIG JOBS YEAR AFTER YEAR

CREATE YOUR PLOW SYSTEM	STEP 1 SELECT A MOUNT	STEP 2 SELECT A FRAME	STEP 3 SELECT A LIFT METHOD	STEP 4 SELECT A BLADE	STEP 5 SELECT ACCESSORIES
MODELS	MOUNT	FRAME	WINCH	BLADES	ACCESSORIES
POLARIS GENERAL XP 1000/4 '20-21	2881763   \$439 <sup>99</sup>	2880260   \$609 <sup>99</sup> <b>TOP SELLER</b>	<b>Polaris PRO HD 4,500 lb. Winch</b> 2883861   \$1,139 <sup>99</sup> POLARIS GENERAL XP 1000/4 '20-21 POLARIS GENERAL 1000/4 '19-21	<b>72" Steel</b> 2880270   \$609 <sup>99</sup> <b>66" Poly</b> 2880269   \$539 <sup>99</sup> <b>66" Steel</b> 2880268   \$469 <sup>99</sup>	<b>72" Blade Snow Deflector</b> 2858541   \$89 <sup>99</sup> <b>72" HD Wear Bar</b> 2879875   \$139 <sup>99</sup> <b>72" Wear Bar</b> 2204976   \$74 <sup>99</sup> <b>66" Blade Snow Deflector</b> 2879866   \$114 <sup>99</sup> <b>66" HD Wear Bar</b> 2879868   \$134 <sup>99</sup> <b>66" Wear Bar</b> 2879867   \$74 <sup>99</sup> <b>Plow Marker</b> 2872726   \$43 <sup>99</sup> <b>66" Blade Plow Shoe</b> 2208864   \$36 <sup>99</sup> <b>Shear Pin</b> 2205527   \$10 <sup>99</sup> <b>Replacement T Shear Pin</b> 2204829   \$7 <sup>99</sup> <b>Extension for Tracks</b> 2880267   \$339 <sup>99</sup> <b>Heavy Duty Deflector</b> 2884160   \$194 <sup>99</sup>
POLARIS GENERAL 1000/4 '16-21			<b>Hydraulic Plow Angle</b> 2885102   \$649 <sup>99</sup> POLARIS GENERAL 1000/4 '16-18 <b>Hydraulic Plow Controller</b> 2883391   \$259 <sup>99</sup> POLARIS GENERAL XP 1000/4 '20-21 POLARIS GENERAL 1000/4 '16-21		

**GLACIER HD**  
PLOW SYSTEM

» 66" Blades

GLACIER HD GIVES YOU

» Choice of poly or steel

» Manual angle system standard



**66" POLY BLADE**  
BEST FOR CORROSION RESISTANCE



**66" STEEL BLADE**  
BEST FOR BIG JOBS YEAR AFTER YEAR

**DURABLE BLADES**  
Choose a steel blade for longevity and increased rigidity or a lightweight non-stick, poly blade that's easier on plowing surfaces.

CREATE YOUR PLOW SYSTEM	STEP 1 SELECT A MOUNT	STEP 2 SELECT A FRAME	STEP 3 SELECT A LIFT METHOD	STEP 4 SELECT A BLADE	STEP 5 SELECT ACCESSORIES
MODELS	MOUNT	FRAME	WINCHES	BLADES	ACCESSORIES
POLARIS GENERAL XP 1000/4 '20-21	2883256   \$309 <sup>99</sup>	2882927   \$609 <sup>99</sup>	<b>Polaris HD 4,500 lb. Winch</b> 2883860   \$809 <sup>99</sup> POLARIS GENERAL XP 1000/4 '20-21 POLARIS GENERAL 1000/4 '19-21	<b>66" Poly</b> 2880269   \$539 <sup>99</sup> <b>66" Steel</b> 2880268   \$469 <sup>99</sup>	<b>66" Blade Snow Deflector</b> 2879866   \$114 <sup>99</sup> <b>66" HD Wear Bar</b> 2879868   \$134 <sup>99</sup> <b>66" Wear Bar</b> 2879867   \$74 <sup>99</sup> <b>Plow Marker</b> 2872726   \$43 <sup>99</sup> <b>66" Plow Shoe</b> 2208864   \$36 <sup>99</sup> <b>Shear Pin</b> 2205527   \$10 <sup>99</sup> <b>Replacement T Shear Pin</b> 2204829   \$7 <sup>99</sup>
POLARIS GENERAL 1000/4 '16-21					



### PROSPECTOR PRO® TRACK MOUNTS

• Install in place of tires and wheels. Tracks sold separately.

» 2880649 • \$649<sup>99</sup>  
POLARIS GENERAL 1000/4 '16-21

**NEW FALL AVAILABILITY**  
» 2885117 • \$649<sup>99</sup>  
POLARIS GENERAL XP 1000/4 '20-21

### PROSPECTOR PRO® TRACK

» 2880758 • \$6,449<sup>99</sup>

POLARIS GENERAL 1000/4 '16-21  
POLARIS GENERAL XP 1000/4 '20-21  
If using Glacier Pro Plow System, Track Plow Extension is required [2880267]

ACCESSORIES  
WINDSHIELDS & REAR PANELS  
DOORS  
ROOF & PROTECTION  
STORAGE, CAB COMFORT & HUNT  
COOLERS  
RIDE COMMAND & AUDIO  
LIGHTING  
WHEELS & TIRES  
WINCHES & PLOWS

# FOR THE LIFE OF YOUR RIDE

**POLARIS ENGINEERS PARTS THAT PUSH THE LIMITS WITHOUT SACRIFICING STRENGTH AND DURABILITY.**

We build our products so anyone with the right tools can maintain their vehicle from their own garage - and get them back on the trails where they belong.

## MAINTENANCE TIP

### BREAK-IN PERIOD

The break-in period for your new GENERAL is the first 25 hours of operation, or the time it takes to use the first two tanks of fuel. No single action on your part is as important as a proper break-in period. Careful treatment of a new engine will result in more efficient performance and longer life for the engine.

**NOTICE:** Excessive heat build-up during the first three hours of operation will damage close-fitted engine parts. Do not operate at full throttle or high speeds for extended periods during the first three hours of use.

SEE OUR LATEST MAINTENANCE TIPS AT [GENERAL.POLARIS.COM/EN-CA/SELF-HELP](http://GENERAL.POLARIS.COM/EN-CA/SELF-HELP)

### AIR FILTERS

A clogged air filter can restrict air flow to the engine leading to reduced engine performance, engine life or catastrophic failure.

### BRAKE PADS

Maintaining and/or replacing brakes are critical to the safety and functionality of a vehicle. Brake pads should be checked for wear and oil or grease (petroleum products) contamination and brake discs should be checked for cracks, excessive corrosion or warping.

### HALF SHAFT

Check for tear and punctures in the boot which can lead to CV joint wear that can contribute to axle failure.

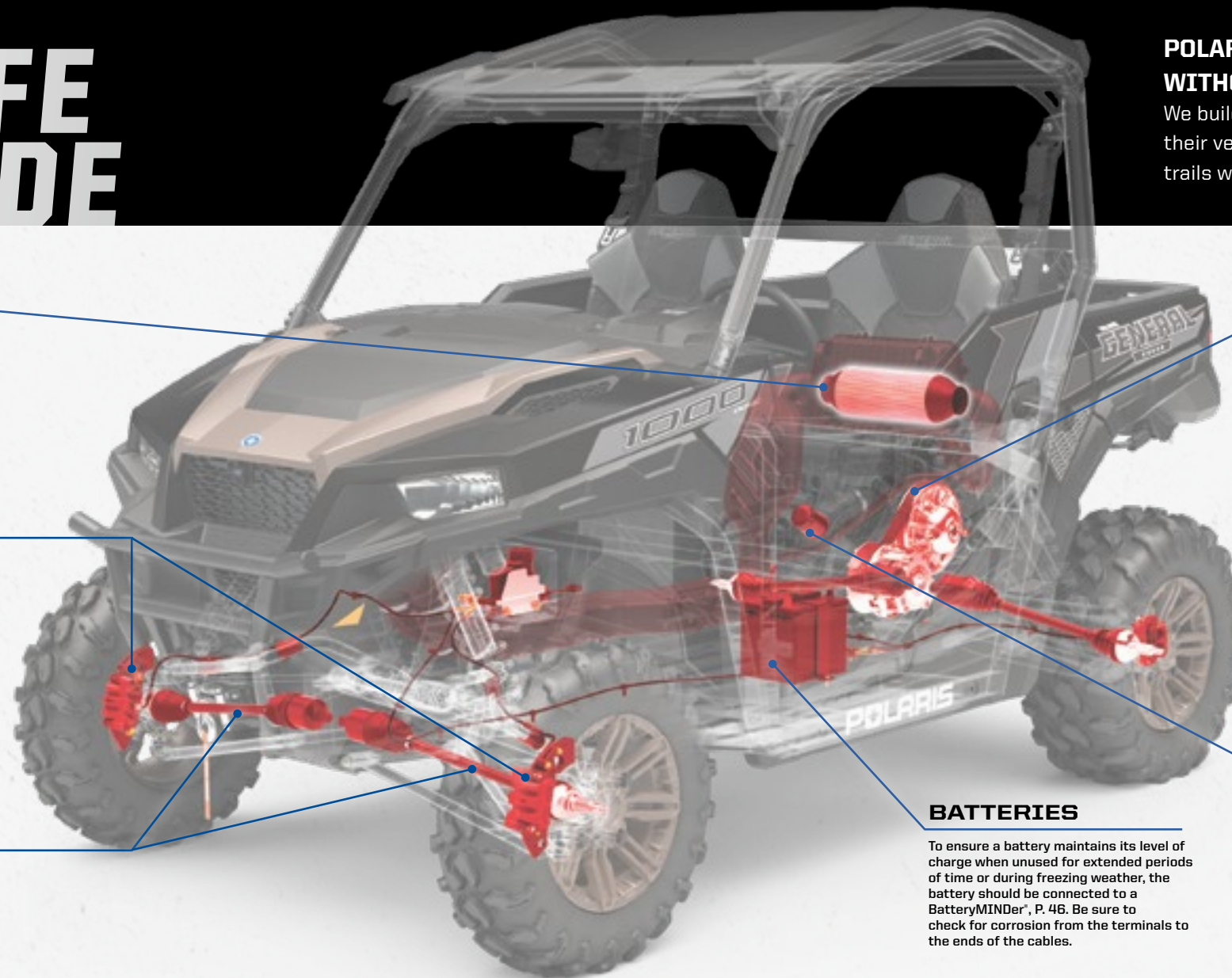

### DRIVE BELTS

Polaris Engineered belts deliver unmatched performance for your off-road vehicle. Developed and tested on all our engines for all environments and conditions. Check your belt for delamination, hour glassing and glazing.

#### BREAK-IN PERIOD

- Use lower gear (if available) while varying speeds and avoiding wide open throttle for 5-10 miles / 8-16 km
- If no low gear is available, vary at moderate speeds while avoiding wide open throttle for 50 miles / 80 km

#### OUR INVESTMENT

- 20,000 miles / 32,187 km of field testing
- Thousands of dyno hours
- 18+ months of development (3,000+ design hours) per belt
- 1200+ vehicle validation hours
- Collaboration with powertrain & clutch engineers

#### YOUR ADVANTAGE

- No clutch recalibration
- Less wear & tear due to heat
- Ensure maximum vehicle performance
- More time riding, less time wrenching
- Produced in collaboration with powertrain and clutch engineers to ensure a perfect fit, maximum performance and ultimate durability

### OIL FILTERS

Change oil filters with every oil change to provide the best engine protection and keep the engine operating at peak performance.

### BATTERIES

To ensure a battery maintains its level of charge when unused for extended periods of time or during freezing weather, the battery should be connected to a BatteryMINDER®, P. 46. Be sure to check for corrosion from the terminals to the ends of the cables.

**FOLLOW RECOMMENDED SERVICE INTERVALS IN THE OWNER'S MANUAL**

## MAINTENANCE SCHEDULE

25 HRS / 250 Mi / 400 km

### BREAK-IN MAINTENANCE

- ENGINE OIL:** CHANGE
- GENERAL LUBRICATION:** ALL FITTINGS, PIVOTS, CABLES, ETC.
- AIR FILTER:** INSPECT & REPLACE AS NEEDED
- EXHAUST SYSTEM:** INSPECT & CLEAN  
INSPECT FOR LEAKAGE OR CARBON BUILD UP AT JOINTS  
INSPECT & CLEAN SCREEN TYPE SPARK ARRESTOR

50 HRS / 500 Mi / 800 km

### 6 MONTHS

- EXHAUST SYSTEM:** INSPECT & CLEAN  
INSPECT FOR LEAKAGE OR CARBON BUILD UP AT JOINTS  
INSPECT & CLEAN SCREEN TYPE SPARK ARRESTOR
- GENERAL LUBRICATION:** ALL FITTINGS, PIVOTS, CABLES, ETC.
- DRIVE BELT:** INSPECT & ADJUST  
REPLACE AS NEEDED

100 HRS / 1000 Mi / 1600 km

### 12 MONTHS

- ENGINE OIL:** CHANGE
- DRIVE BELT:** INSPECT & ADJUST  
REPLACE AS NEEDED
- TRANSMISSION FLUID:** CHANGE
- AIR FILTER:** INSPECT & REPLACE AS NEEDED
- EXHAUST SYSTEM:** INSPECT & CLEAN  
INSPECT FOR LEAKAGE OR CARBON BUILD UP AT JOINTS  
INSPECT & CLEAN SCREEN TYPE SPARK ARRESTOR

150 HRS / 1500 Mi / 2400 km

### 18 MONTHS

- ENGINE OIL:** CHANGE
- BATTERY:** TEST, CLEAN, & CHECK FLUID LEVEL  
REPLACE AS NEEDED
- DRIVE BELT:** INSPECT & ADJUST  
REPLACE AS NEEDED
- TIRES:** INSPECT CONDITION & PRESSURE
- EXHAUST SYSTEM:** INSPECT & CLEAN  
INSPECT FOR LEAKAGE OR CARBON BUILD UP AT JOINTS  
INSPECT & CLEAN SCREEN TYPE SPARK ARRESTOR

200 HRS / 2000 Mi / 3200 km

### 24 MONTHS

- ENGINE OIL:** CHANGE
- BRAKE PADS & FLUID:** INSPECT & CLEAN  
REPLACE BRAKE FLUID  
REPLACE AS NEEDED
- SPARK PLUGS:** INSPECT  
REPLACE AS NEEDED
- AIR FILTER:** INSPECT & REPLACE AS NEEDED
- EXHAUST SYSTEM:** INSPECT & CLEAN  
INSPECT FOR LEAKAGE OR CARBON BUILD UP AT JOINTS  
INSPECT & CLEAN SCREEN TYPE SPARK ARRESTOR

250 HRS / 2500 Mi / 4023 km

### 30 MONTHS

- ENGINE OIL:** CHANGE
- BATTERY:** TEST, CLEAN, & CHECK FLUID LEVEL  
REPLACE AS NEEDED
- DRIVE BELT:** INSPECT & ADJUST  
REPLACE AS NEEDED
- GENERAL LUBRICATION:** ALL FITTINGS, PIVOTS, CABLES, ETC.
- EXHAUST SYSTEM:** INSPECT & CLEAN  
INSPECT FOR LEAKAGE OR CARBON BUILD UP AT JOINTS  
INSPECT & CLEAN SCREEN TYPE SPARK ARRESTOR

300 HRS / 3000 Mi / 4828 km

### 36 MONTHS

- ENGINE OIL:** CHANGE
- AIR FILTER:** INSPECT & REPLACE AS NEEDED
- GEARCASE & TRANSMISSION:** REPLACE FLUIDS
- EXHAUST SYSTEM:** INSPECT & CLEAN  
INSPECT FOR LEAKAGE OR CARBON BUILD UP AT JOINTS  
INSPECT & CLEAN SCREEN TYPE SPARK ARRESTOR

CHECK YOUR OWNER'S MANUAL FOR ADDITIONAL RECOMMENDED SERVICE ITEMS AND VEHICLE-SPECIFIC TIMING

### FOR THE LIFE OF YOUR RIDE ONLY THE BEST WILL DO

To create the best oil for any terrain, we invest in rigorous testing to ensure our oil delivers the consistency and performance you demand.

#### WHAT COUNTS IN OIL TESTING:

1. Does it protect the engine at high temperatures?
2. Does it keep the engine free from carbon and buildup?
3. Does the oil hold its viscosity over time?

#### ENGINE CHECKPOINTS

Polaris engineers focus on key areas within the engine when evaluating engine oil and its ability to protect the life of your ride. Critical checkpoints include:



**PISTON RINGS & RING LANDS:** Extreme pressure to these parts require high lubricant film strength. Poor oxidative performance can lead to carbon and varnish buildup, which results in poor ring seal and fuel dilution of the oil. These can result in loss of power and accelerated engine wear.



**ROD BEARINGS:** Engine bearings on an oil with low film strength and thinner viscosity can lead to premature wear or even engine failure.



**CAMSHAFT:** Direct acting overhead camshafts are used on many Polaris engines. In this application the camshaft pushes directly on the valve, creating very high contact pressures compared to other camshaft configurations. These forces are so great that inferior oil can break down leading to increased wear and potential engine damage.

100 HR Polaris Endurance Dynamometer Engine Test Platform: RZR 1000 Oil Used: PS-4 5W50

## SPECIFIC NEEDS, SPECIFIC OILS

### PS-4 FULL-SYNTHETIC OIL

PS-4 is optimal for ambient operating temperatures of -40° F to 100° F

#### OUR FORMULATION

- Full-synthetic formula with wide, 5W-50 viscosity range
- Extreme cold weather flow and startup protection
- Maximum rust and corrosion protection
- Proprietary anti-wear additive system

#### YOUR ADVANTAGE

- All-weather engine protection
- Easy starting in all conditions
- Internal engine protection from extreme temperature fluctuations and periods of non-use or storage
- Reduced friction, protects cams, pistons, bearing and valvetrain components from wear

### PS-4 EXTREME-DUTY FULL-SYNTHETIC OIL

PS-4 Extreme Duty is optimal for ambient operating temperatures of 0° F to 130° F

#### OUR FORMULATION

- Extreme high-temperature engine protection
- Full-synthetic formula with strong, 10W-50 Viscosity Range
- Protects against rust and corrosion of internal engine parts during periods of non-use or storage

#### YOUR ADVANTAGE

- High-strength film protection withstands extreme heat, stress and sustained high RPM conditions
- Extremely shear stable, maintains viscosity under heat and stress
- Protects engine from moisture that can build up inside the engine as a result of extreme temperature fluctuations

### OIL CHANGE KITS

These convenient kits include everything you need to change your oil. The correct filter and oil volume for your vehicle.

PS-4	PS-4 EXTREME DUTY	
PART NUMBER	VEHICLE FITMENT	PART NUMBER
2202166	RANGER/RZR/SPORTSMAN 570, TWIN 600, TWIN 700, TWIN 800	2879004
2879323	RANGER, POLARIS GENERAL, RZR 900/1000, RS1	2879324
2877473	RANGER/ SPORTSMAN 300-500, SPORTSMAN/SCRAMBLER 500/850/1000	2878924
2881696	RZR TURBO	2881697

- › 1 Quart 2876244
- › 1 Gallon 2876245
- › 16 Gallons 2876247
- › 55 Gallon Drum 2876246
- › 330 Gallon Tote 2878814

- › 1 Quart 2878920
- › 1 Gallon 2878919
- › 16 Gallons 2879003
- › 55 Gallon Drum 2879002
- › 330 Gallon Tote 2879001

#### SUPERIOR ENGINE PROTECTION

- Polaris Engineered PS-4
- Leading Aftermarket Synthetic ATV/UTV Oil
- Leading Aftermarket ATV Oil
- National Brand Synthetic Diesel Oil

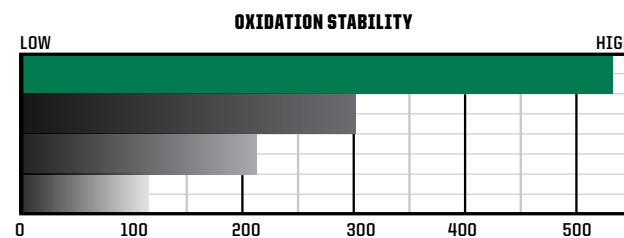

**Higher Number = Longer Oil Life**  
Polaris proprietary additive system resists the negative effects of oil oxidation longer than leading aftermarket and automotive engine oils.

#### CLEAN ENGINE, LOWER DEPOSITS

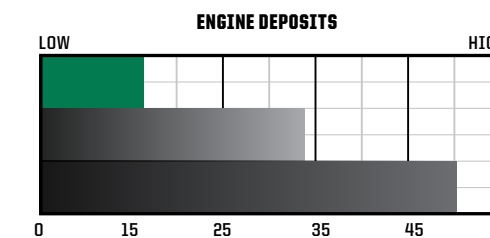

**Clean Engine Test**  
Lower Number = Less Deposits, Cleaner Engine Operates at Peak Performance.  
ASTM Test D6335

## OIL DEVELOPMENT

POLARIS INVESTS IN EACH OIL AT AND ABOVE THESE LEVELS.

38 POLARIS.COM/ShopGENERAL

**12 DEDICATED TEAM MEMBERS**

**FOCUSED ON POLARIS OIL**

**18+ MONTHS**

**DEVELOPMENT & TESTING**

**75,000+ HOURS**

**DYNO TESTING**

**64,374 KILOMETERS**

**FIELD TESTING (1.8 MILLION MILES)**

# MAINTENANCE FLUIDS



## ENGINE OIL

Maximum protection for your 4-cycle engine.

Change every 100 hours, 6 months or 500 miles / 800 km.



## AGL

Protect gears, drive chain, and bearings from scoring and wear.

Change every 100 hours, 12 months or 1000 miles / 1600 km.

- » 1 QT. • 2878068
- » 1 GAL. • 2878069
- » 2.5 GAL. • 2878070
- » 55 GAL. • 2879594



## SUSPENSION/ U-JOINT GREASE

A heavy-duty lubricant formulated with molybdenum disulfide to accept the high shock applications of Polaris ATV shaft drive universal joints.

Add every 50 hours, 3 months or 500 miles / 800 km.

- » 3 OZ. • 2871515
- » 14 OZ. • 2871551

## ORV MAINTENANCE KIT

Everything you need, in the correct fluid volumes, to maintain your drive train, and keep your vehicle in top operating condition

Includes: 1.5 qts. AGL, 1 qt. Angle Drive Fluid, 1 pint Demand Drive Fluid, 1-3 oz. tube of All-Season Grease

- » 2880425



## DOT 4 BRAKE FLUID

A high-quality brake fluid designed for use in Polaris hydraulic brakes.

Change every 200 hours, 2000 miles / 3200 km or every 2 years.

- » 12 OZ. • 2872189



## ANTI-FREEZE

Prevent corrosion on metal components, eliminate scaling, and maximize cooling system performance.

Change every 60 months.

- » 1 QT. • 2880514
- » 1 GAL. • 2880513
- » 55 GAL. • 2880512



## DEMAND DRIVE FLUID

Provide positive 4WD engagement in extreme cold or high head conditions and protect internal components under heavy loads.

Change every 100 hours or yearly.

- » 1 QT. • 2877922
- » 2.5 GAL. • 2877923



# LUBRICANT ACCESSORIES



## NEW OIL FILTER WRENCH

Remove Polaris ORV oil filters with ease.

- » 2830550 • \$10<sup>99</sup>



## NEW FLUID FUNNEL

Easily add oil with high accuracy.

- » 2830552 • \$17<sup>99</sup>



## NEW FLUID TRAY

Holds up to 8 quarts of fluid.

- » 2830551 • \$26<sup>99</sup>



## NEW FLUID SYRINGE

Easily add and remove fluid from your vehicle.

- » 2830553 • \$39<sup>99</sup>



## GREASE GUN

Enables easy application of grease.

- » 2871312 • \$44<sup>99</sup>

FITS 2871322 ALL-SEASON AND 2871515 U-JOINT 3 OZ.



## 20 BATTERY-OPERATED SIPHON PUMP

Liquid transfer pumps 5-6 quarts/min suctioning power.

- » 2830513 • \$20<sup>79</sup>



## FLEX SPOUT

Fits all Polaris quart, gallon and 2.5 gallon bottles.

- » 2871285 • \$3<sup>99</sup>



## PUMP

Fits 1 and 2.5 gallon bottles.

- » 2870465 • \$9<sup>99</sup>



## PREMIUM GAS SHOCK OIL

Specialized shear stable blend containing high levels of anti-wear anti-foam & oxidation

- » 1 QT. • 2870995
- » 2.5 GAL. • 2872279

FOX® REBUILDABLE SHOCKS



## 10WT GAS SHOCK OIL

Specialized fluid to ensure proper gas shock absorber action

- » 1 QT. • 2874124

WALKER EVANS® REBUILDABLE SHOCKS



## CHAIN LUBRICANT

Provides superior anti-wear and shock protection

- » 16 OZ. AEROSOL 2872348



## ALL-SEASON GREASE TUBE

Specialized water resistant lubricant

- » 3 OZ. • 2871322
- » 14 OZ. • 2871423



## ANGLE DRIVE FLUID

Extreme pressure, anti-wear and high viscosity film lubrication for maximum protection

- » 1 QT. • 2876160
- » 2.5 GAL. • 2872276

SPORTSMAN, RANGER, RZR ANGLE DRIVE GEAR CASE SYSTEMS



## GENERATOR OIL

4-Cycle Engine Oil

- » 1 QT. • 2879383



## CARBON CLEAN

Ultimate fuel and injection system cleaner

- » 12 OZ. • 2881413



## ADVANCED FUEL TREATMENT

Dual Antioxidant formula protects jets and fuel system from gum and varnish

- » 12 OZ. • 2881416
- » 2.5 GAL. • 2881417

# SERVICE PARTS

Polaris Engineered service parts deliver unmatched performance and fit for your off-road vehicle.

All service parts are engineered specifically for your machine. Which means everything is designed, tested and perfected to maximize the life of your ride. Getting Polaris Engineered parts is a decision that pays off in the long run, because it ensures there is a long run.



SHOP FOR SERVICE PARTS ONLINE OR VISIT YOUR POLARIS DEALER.

OVER  
**100,000**  
PARTS  
AVAILABLE!



CHECK OUT OUR PARTS FINDER ON POLARIS.COM  
FOR EASY PARTS LOOK-UP, PARTS IDENTIFICATION, VIEWS OF ASSEMBLIES & MORE!

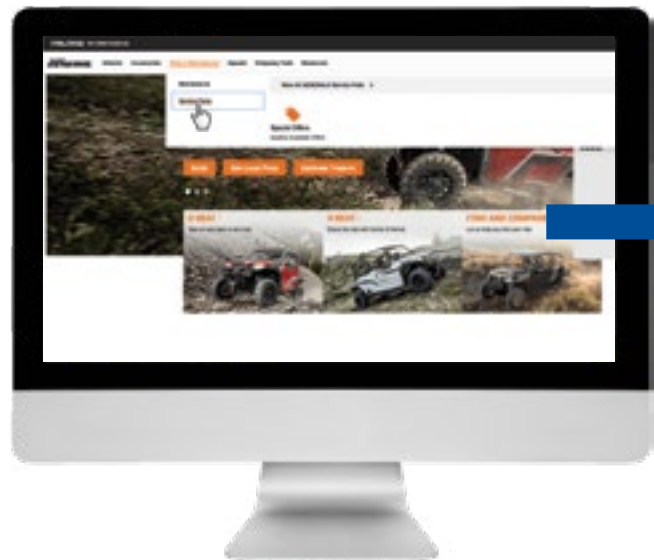

## STEP 1

Visit [Polaris.com/GENERAL](https://Polaris.com/GENERAL)  
Click "Parts & Service" tab  
Click "Service Parts"



## STEP 2

Enter **vehicle year/model** or shop by **part number**



## STEP 3

Clearly see what parts are required and **order**

Assembly  
DRIVE SHAFT, FRONT HALF SHAFT - R18GE06M88B07K85U88U8G (2016)

R18GE06M88B07K85U88U8G POLARIS GENERAL 1000 EPS (2016) (214)

Zoom In Zoom Out

ARI PartStream

© 2017 Polaris Industries Inc. 701676

Qty	Part #	Description	Price	Qty	Add
1	132948	ASH-HALF-SHAFT-FRONT-ES	\$299.99	2	Add
2	323460	ASH-OUTER JOINT (P4-6006)	\$119.99	1	Add
3	320340	KIT-BOOPL/UNDER JOINT(P4-6002)	\$44.99	2	Add
4	323461	SHAFT (P4-6010)	\$40.99	1	Add
5	320337	ASH-INNER JOINT	\$114.99	1	Add
6	320345	CIRCLIP-1.6X24 (P4-6026)	\$2.99	1	Add
7	320347	CIRCLIP-1.6X22 (P4-6010)	\$2.99	2	Add
8	320346	GRASER-KIT-SYNTRAC	\$11.79	2	Add

# HD HEAVY DUTY PARTS



All Polaris parts are developed and tested to help you get the most out of your ride. Now, we're taking the passion of our riders, workers, and outdoor enthusiasts to the next level with HD Parts.

Engineered & designed for:

- Greater durability
- Enhanced performance
- Greater wear & tear capabilities
- All weather conditions

## NEW WHEELS & TIRES

Class leading durability for off-road performance and traction for confident driving in extreme conditions.

- » 1524022-458 • HD WHEEL - 14x7 (SHOWN)
- » 5417507 • PRO ARMOR HD-K - 29x10R14 (SHOWN)
- » 5457498-458 • HD WHEEL CENTER CAP (SHOWN)
- » 5415756 • PRO ARMOR XD-K FRONT
- » 5415757 • PRO ARMOR XD-K REAR

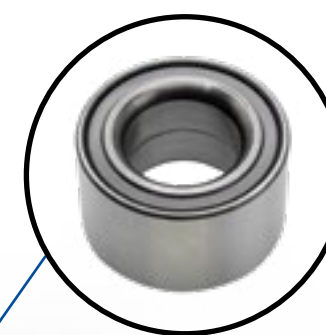
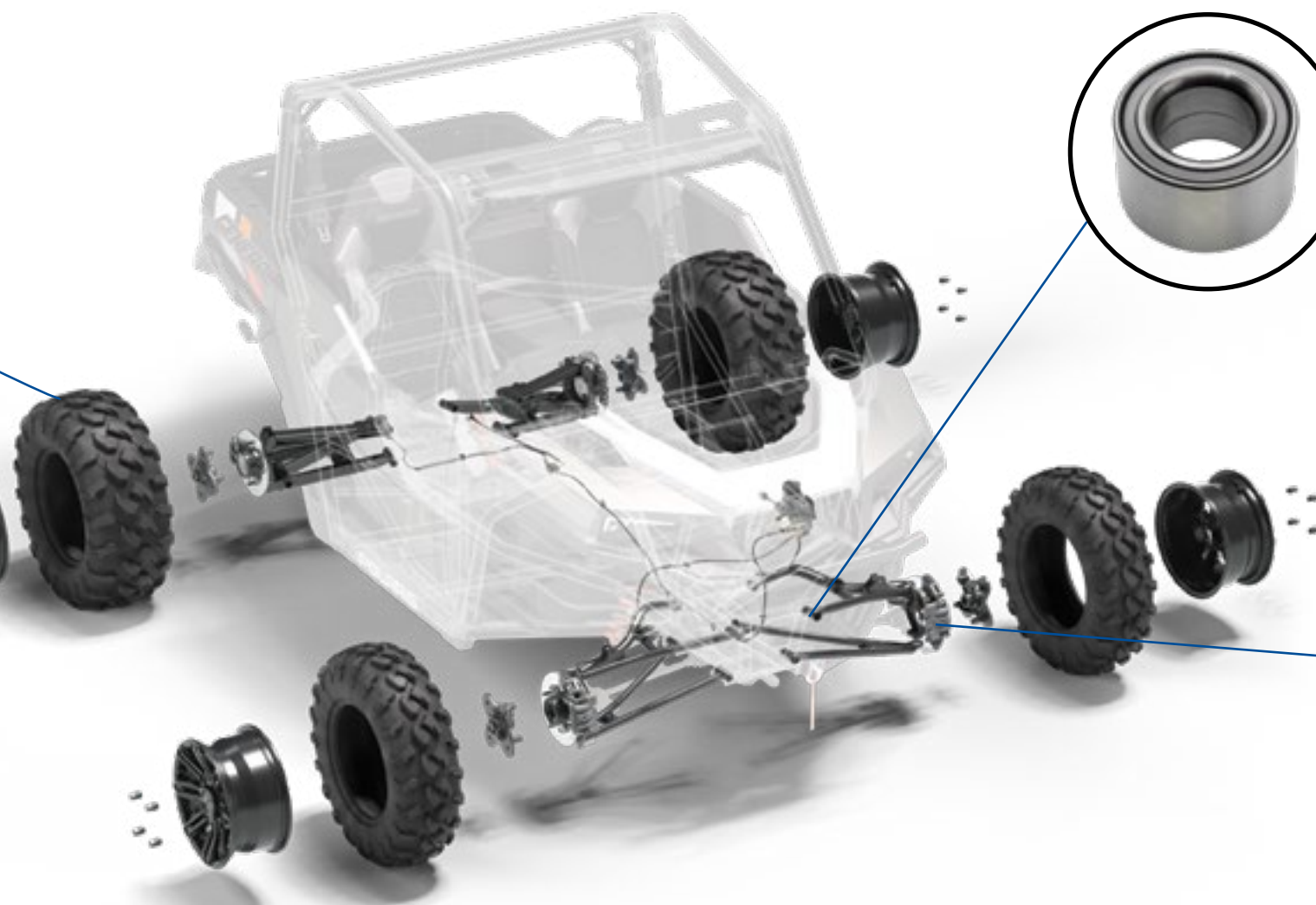

## NEW WHEEL BEARINGS

Fully sealed for added protection against intrusions. Made of a higher grade steel for extended life in extreme conditions.

LOCATION	OE	HD HEAVY DUTY PARTS
FRONT WHEEL BEARING		
REAR WHEEL BEARING	3514924	3515090

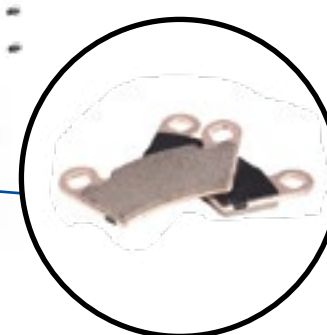

## COMING SOON BRAKES

Engineered to provide longer life and better stopping power while riding in extreme conditions.

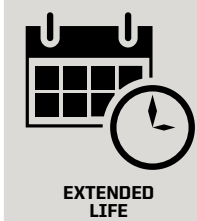
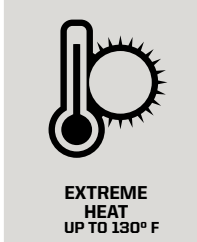
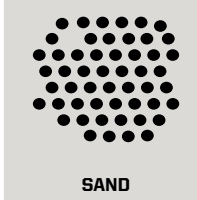

\*Claims made based off testing and performance of Polaris HD Parts against standard OEM parts made by Polaris and competitor brands under normal use.

For more information regarding Polaris HD parts including vehicle compatibility, installation, and maintenance, please contact your authorized Polaris ORV dealer.

VISIT [POLARIS.COM/HDPARTS](https://www.polaris.com/hdparts) TO LEARN MORE



# BatteryMINDER®

ENSURE YOUR RIDE IS READY WHEN YOU ARE.

- Add years of capacity, power and range to new and older batteries, regardless of type or brand
- Never over- or under-charged in any temperature
- Leave your vehicle connected for months and return to fully charged and conditioned batteries
- Recover older or weak batteries that would normally need to be replaced

- Charge and maintain extra backup batteries as well as those in your vehicle
- Automatic turn-on, sleeps while keeping your batteries at full charge
- Easy push-button selector to change battery type or time



	2012 AGM 2-AMP	2012 LEAD ACID 2 AMP	1510 1.5 AMP	1.5 AMP CONVERTIBLE
PART NUMBER   PRICE	2830438   \$121 <sup>99</sup>	2830531   \$109 <sup>99</sup>	2830404   \$79 <sup>29</sup>	2830511   \$91 <sup>49</sup>
VOLTAGE   WARRANTY	12 V   5 Years	12 V   5 Years	12 V   10 Years	12 V   5 Years
CHARGING CURRENT	2AMP	2AMP	1.5AMP	1.5AMP
OVERCHARGE PROTECTION	Yes			
BATTERIES MAINTAINED	6 at one time		4 at one time	
BATTERY COMPATIBILITY	12 V Sealed AGM Lead-Acid	12 V Flooded (filler cap) and Sealed Maintenance-Free Batteries		
COMES WITH	• Non-fused battery clip cord set with Quick Connector	• BC-2410: 2' Non-fused battery clip cord set with Quick Connector • RTA-2415: 2' Fused ring terminal cord set with Quick Connector • ATS-1: Ambient Temperature Sensor	• Ambient temperature sensor (installed) • 12' power cord • Battery clip cord set with Quick Connector	• Auto-temp compensation sensor (installed) • Optional permanent mounting brackets & screws • Battery clips (fully-insulated, aircraft grade, 15A replaceable fuse) • Ring terminal assembly with 15A replaceable fuse
KEY FEATURES	Designed for high-performance specialty AGM sealed batteries	Diagnoses battery's condition - can predict failing batteries	Easy to use, economical	Convertible on-vehicle or bench top use

## BATTERY MAINTENANCE TIPS

Extend your battery life with a BatteryMINDER® and these tips.

1. Store batteries in a cool, dry location.
2. Check that the battery connections are tight. Cables should not be able to be rotated or shifted by hand.
3. If your battery has a drain tube, make sure it is free of clogs.
4. Clean your battery - use a soft brush to scrub the top of the battery. Use baking soda to remove grease.
5. Connect a BatteryMINDER® after using your vehicle even if the vehicle is in regular use.

## BatteryMINDER® ACCESSORIES



**BatteryMINDER® 12' CABLE**

- Made with heavy-duty 16 gauge black zip cord featuring automotive SAE bullet connectors

» 2830410 • \$15<sup>99</sup>



**BatteryMINDER® VPP-12:12/24 VOLT VEHICLE POWER PLUG**

- Allows easy connection to vehicle's battery through lighter or 12/24V power port with replaceable 15 amp fuse

» 2830518 • \$12<sup>99</sup>



**BatteryMINDER® SPLITTER**

- Connect two batteries simultaneously for easy battery maintenance
- Cap includes a set of ring terminals

» 2830409 • \$30<sup>99</sup>



**BatteryMINDER® RING TERMINAL**

- Features 24-inch long 18-gauge wire
- Plug has standard 5/16" negative and 3/8" positive terminals
- Replaceable 15 amp in-line fuse for circuit protection

» 2830437 • \$12<sup>99</sup>



**BatteryMINDER® EZ CONNECT**

- Allows for quick and easy connecting and disconnecting of your BatteryMINDER®
- Includes a set of ring terminals

» 2830411 • \$42<sup>99</sup>

# TIRE SEALANT

## HOW IT WORKS

Tire sealant remains liquefied inside your tire until a leak develops in the tire or wheel.



Once a leak occurs, the tire sealant rushes out of the tire and quickly creates a permanent solid plug.

The plug maintains the pressure of the tire so you can continue your ride.



## HOW MUCH TIRE SEALANT DO YOU NEED?

$$\begin{array}{ccc} \text{TIRE HEIGHT (IN.)} & \times & \text{TIRE WIDTH (IN.)} \\ \hline \text{Ex: } 27" & \times & 10" \\ \hline & / & 5 = \\ & & 54 \text{ oz.} \end{array}$$

FOR A FULL APPLICATION CHART, VISIT [POLARIS.COM/TIRESEALANTCHART](http://POLARIS.COM/TIRESEALANTCHART)

## PREMIUM TIRE SEALANT

- Instantly seals and repairs rim, bead leaks, and punctures up to 1/4" on standard tires, and 3/4" on heavy ply tires
- Helps maintain air pressure for the life of the tire
- Helps seal the tire bead against the wheel
- 100% water soluble for easy cleanup
- Will not rust, corrode, or pit wheels
- Creates permanent repair
- Remains fluid and effective in temperatures down to -45° F
- Easily installed through existing tire valve stem with valve core removed

» 32 OZ. • 2830484 • \$25<sup>99</sup>  
» 1 GALLON • 2830485 • \$89<sup>99</sup>  
» 5 GALLON • 2830486 • \$364<sup>99</sup>  
» 5 GALLON PUMP • 2830487 • \$163<sup>49</sup>

» 55 GALLON • 2830489  
» 275 GALLON • 2830488

24 X 7 COVERAGE | BE PREPARED FOR ANYTHING

## SHOP ACCESSORIES



### POLARIS X3 CREEPER

- Three positions: flat, 45-degree angle or seated work stool
- Helps you perform any repair with ease
- Stay dry and warm away from cold, wet cement floors
- Easily stores away when not in use

» BLACK • 2830429 • \$182<sup>99</sup>



**POLARIS MAGNETIC PARTS TRAY**

» SILVER • 2830432 • \$18<sup>99</sup>



**POLARIS 33" TELESCOPIC MAGNET**

» BLACK • 2830435 • \$6<sup>99</sup>



**POLARIS 12" HI-TORQUE RATCHETING DRIVER**

» BLACK / BLUE • 2830434 • \$24<sup>99</sup>



**POLARIS LED POCKET FLASHLIGHT**

» BLACK • 2830436 • \$30<sup>99</sup>

# CV BOOT REPAIR KIT

FIX ON THE GO | TEMPORARY COVERAGE

- A quick trail side fix to increase trail time
- The flexible and durable boot material expands over a cone tool for CV boot repairs, without disassembling CV axles
- Universal fit – works as a temporary fix for most powersports axles
- All components fit inside the cone, and a cover is provided for compact durable storage
- Easily fits in a cargo box, attached to the roll cage, in the glovebox, or many other storage locations



Items shown are contained inside cone

## UTV CV BOOT REPAIR KIT

Kit includes the following items:

- (1) Expandable XL CV Boot
- (1) Reusable Cone Tool
- (2) CV Boot Clamps
- (1) Tube of Silicone Lube
- (1) Grease Packet
- (1) Cone Cover

» 2830526 • \$36<sup>99</sup>

## UTV TRAIL BOOT ONLY

» 2830527 • \$18<sup>99</sup>

## ATV

» CV REPAIR KIT 2830528 • \$31<sup>99</sup>  
» TRAIL BOOT ONLY 2830529 • \$18<sup>99</sup>

SEE HOW THE CV BOOT REPAIR KIT WORKS AT [POLARIS.COM/MAINTENANCE-VIDEOS](http://POLARIS.COM/MAINTENANCE-VIDEOS)

### HOW TO INSTALL

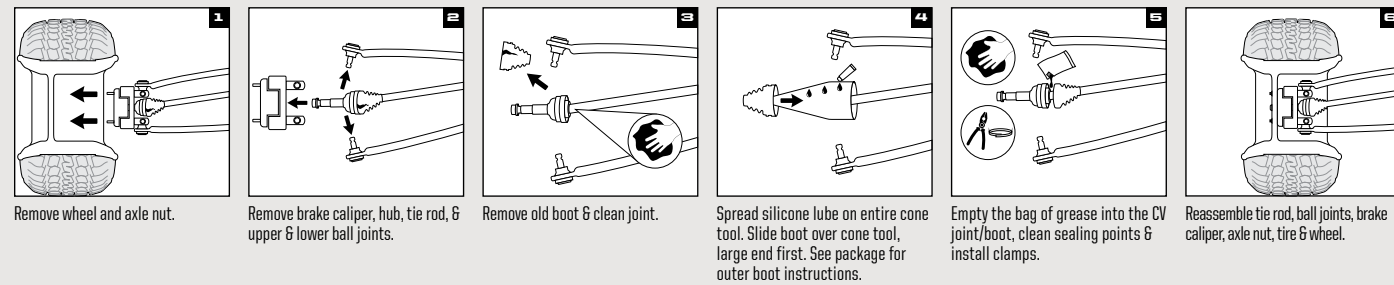

Refer to your service manual for further instructions and torque specifications.  
\*Designed for temporary CV boot repair. Purchase the OEM CV Boot for a permanent repair.

# KEEP IT CLEAN

## VEHICLE SHINE

### MUD SHIELD PRE-TREATMENT

- Inhibits the adhesion of dirt, mud, and snow, making cleaning your vehicle faster and easier.

» 16 OZ. AEROSOL • 2830229 • \$14<sup>99</sup>



### POLARIS POLISH

- Easy protection and shine—spray on, wipe off, and go. For ideal use on painted and plastic surfaces. Contains carnauba wax.

» 12 OZ. • 2830228 • \$12<sup>99</sup>



### VEHICLE & EQUIPMENT WASH

- Concentrated professional grade formula powers through vehicle buildup, dirt and grease with a spot-free rinse. Treat up to 32 gals. Biodegradable product.

» 1 GAL. • 2830417 • \$19<sup>99</sup>  
» 5 GAL. • 2830422 • \$69<sup>99</sup>



## SHOP

### POLARIS SHOP TOWELS

» 200 CT WITH DISPENSER (SHOWN) 2830402 • \$28<sup>99</sup>  
» 200 CT REFILL • 2830403 • \$19<sup>99</sup>  
» 64 CT REFILL • 2830440 • \$6<sup>99</sup>



### POLARIS HEAVY-DUTY SCRUBBER WIPES

» 90 CT • 2830441 • \$24<sup>99</sup>



### ALL-PURPOSE CLEANER PLUS

- Professional-grade formula removes built-up stains from shop floors, work benches, and other hard surfaces. VOC-free, environmentally-friendly, and biodegradable.

» 1 GAL. • 2830414 • \$19<sup>99</sup>  
» 5 GAL. • 2830416 • \$69<sup>99</sup>



### HD CLEANER & DEGREASER

- Professional-grade, biodegradable, high-foaming formula dissolves and removes tough stains and soils.

» 1 GAL. • 2830418 • \$23<sup>99</sup>  
» 5 GAL. • 2830420 • \$95<sup>99</sup>



# BRING IT EVERYWHERE

## TRAILERING



### CALIBER® RAMP PRO

- Designed for ATVs and UTVs up to 50" wide
  - Integrated grip glides for ultimate traction
  - Folding sides for easy transportation & storing
- » 52" x 90" • 2884576 • \$519<sup>99</sup>



### ALUMINUM ARCHED LOADING RAMPS

» 76" x 12" • 2,000 lb • 2875384 • \$279<sup>99</sup>  
» 88" x 12" • 3,000 lb • 2875386 • \$459<sup>99</sup>



### LIGHTWEIGHT TRI-FOLD RAMPS

- Ramp folds up for transport
  - Capacity for up to 1,500 lb
  - Safety straps included
- » 72" x 51" • 2875385 • \$309<sup>99</sup>  
» 82" x 51" • 2875860 • \$369<sup>99</sup>

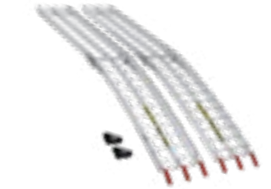

### FOLDING ALUMINUM ARCHED RAMPS

- Ramp folds up for transport
  - Capacity up to 3,000 lb
  - Safety straps included
- » 88" x 12" • 2875387 • \$379<sup>99</sup>

## HITCHES

### 3:1 HITCHES VERSATILE 3 IN 1 FUNCTIONALITY

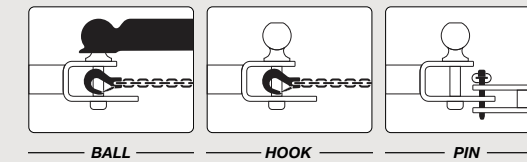

- Ball, pin and hook design
- Durable, rust resistant steel with black powdercoated finish
- Removable ball
- HD 5/8" pin and clip



### HITCH WITH 2" BALL

» 2" x 2" RECEIVER 2830522 • \$48<sup>99</sup>  
» 1 1/4" x 1 1/4" RECEIVER 2830523 • \$48<sup>99</sup>



### 1 7/8" BALL

• 1 7/8" replacement ball for hitch  
• Designed to work with 3:1 Hitch  
» 2830524 • \$12<sup>99</sup>



### RECEIVER HITCH

» 2" RECEIVER TONGUE 2875320 • \$59<sup>99</sup>  
» FRONT HITCH RECEIVER 2878846 • \$169<sup>99</sup>



### TRAILER BALL 3/4" SHANK

» 1 7/8" BALL • 2877602 • \$18<sup>99</sup>  
» 2" BALL • 2877603 • \$18<sup>99</sup>

## STRAPS & ROPES



### RECOVERY STRAP

• 2" x 30' (18,000 lb)  
• Comes with carry bag  
» 2884033 • \$74<sup>99</sup>



### RATCHET STRAP

• 1.5" x 15' straps, 2 Pack  
• Heavy duty webbing  
• 5,500 lb maximum load, 1,833 lb working load  
» 2884031 • \$59<sup>99</sup>



### RATCHET STRAP

• 2" x 20' Ratchet Straps  
• Heavy duty webbing, floating D-rings, double J-hooks  
• 10,000 lb maximum load, 3,300 lb working load  
» 2884032 • \$43<sup>99</sup>



### SHOCK STRAPS

• 1.5" 3,000 lb breaking strength  
• Keeps tension on tie-down straps to secure load, 2 Pack  
» 1.5" x 15' • 2883296 • \$109<sup>99</sup>  
» 1.5" x 7' • 2883295 • \$94<sup>99</sup>

## COVERS



### TRAILERABLE COVER BY POLARIS

» 2-SEAT • 2881841 • \$469<sup>99</sup>  
POLARIS GENERAL XP 1000 '20-21  
POLARIS GENERAL 1000 '16-21  
» 4-SEAT • 2881787 • \$539<sup>99</sup>  
POLARIS GENERAL XP 4 1000 '20-21  
POLARIS GENERAL 4 1000 '17-21



### POLARIS SxS CAMO FIELD COVER

» 2882160 • \$169<sup>99</sup>  
POLARIS GENERAL XP 1000/4 '20-21  
POLARIS GENERAL 1000/4 '16-21

PARTS & GARAGE

MAINTENANCE

OIL & LUBRICANTS

MAINTENANCE FLUIDS

SERVICE PARTS

HD PARTS

BATTERIES & TIRE SEALANT

VEHICLE CARE & TRAILERING

POLARIS POWER



<b>NEW</b> <b>P2000i</b> Inverter Generator	2830532	<b>\$899 99</b>	<b>1600</b> Running Watts	<b>2000</b> Starting Watts	<b>16.7</b> Max Amps at 120V	<b>7.6</b> Run Time at 25% Load w/ Smart Throttle (hrs)	<b>62</b> Noise Level at 25% Load (dBA)
---------------------------------------------------	---------	-----------------	------------------------------	-------------------------------	---------------------------------	------------------------------------------------------------	--------------------------------------------

### FEATURES



Extension Cord Management



Multi Functional Digital Display



Illuminated Control Panel



Multi Handle Design



Parallel Capable

### BEST USED FOR



Tailgating



Off-Grid



Camping



**ACCESSORIES** 2830536 INVERTER PARALLEL KIT  
2830540 ALL WEATHER COVER

2884865 HIGH ALTITUDE MODIFICATION KIT  
2879383 GENERATOR OIL

<b>NEW</b> <b>P3200iE</b> Inverter Generator	2830533	<b>\$1899 99</b>	<b>2800</b> Running Watts	<b>3200</b> Starting Watts	<b>23.3</b> Max Amps at 120V	<b>10.1</b> Run Time at 25% Load w/ Smart Throttle (hrs)	<b>67</b> Noise Level at 25% Load (dBA)
----------------------------------------------------	---------	------------------	------------------------------	-------------------------------	---------------------------------	-------------------------------------------------------------	--------------------------------------------

### FEATURES



Key Fob Remote Start



Multi Functional Digital Display



Fuel Gauge



Extension Cord Management



Parallel Capable

### BEST USED FOR



DIY Remodeling



One Room Backup



Camping



**ACCESSORIES** 2830536 INVERTER PARALLEL KIT  
2830541 ALL WEATHER COVER

2884866 HIGH ALTITUDE MODIFICATION KIT  
2879383 GENERATOR OIL



<b>NEW</b> <b>P5500</b> Open Frame Generator	2830534	<b>\$1799 99</b>	<b>5000</b> Running Watts	<b>5500</b> Starting Watts	<b>20/30</b> Max Amps at 120/240V	<b>5</b> Run Time (hrs)	<b>75</b> Noise Level (dBA)
----------------------------------------------------	---------	------------------	------------------------------	-------------------------------	--------------------------------------	----------------------------	--------------------------------

**FEATURES**



Extension Cord Management



Fuel Gauge



Electric Start



Rough Terrain Wheel

**BEST USED FOR**

-  Construction
-  Home Backup
-  RV'ing



**ACCESSORIES**    2830542 ALL WEATHER COVER  
 2884867 HIGH ALTITUDE MODIFICATION KIT

2879383 GENERATOR OIL

<b>NEW</b> <b>P6500</b> Open Frame Generator	2830535	<b>\$1999 99</b>	<b>6000</b> Running Watts	<b>6500</b> Starting Watts	<b>20/30</b> Max Amps at 120/240V	<b>5</b> Run Time (hrs)	<b>75</b> Noise Level (dBA)
----------------------------------------------------	---------	------------------	------------------------------	-------------------------------	--------------------------------------	----------------------------	--------------------------------

**FEATURES**



Extension Cord Management



Fuel Gauge



Electric Start



Rough Terrain Wheel

**BEST USED FOR**

-  Construction
-  Home Backup
-  RV'ing



**ACCESSORIES**    2830542 ALL WEATHER COVER  
 2884867 HIGH ALTITUDE MODIFICATION KIT

2879383 GENERATOR OIL

VISIT [POLARISPOWER.COM](http://POLARISPOWER.COM)  
 FOR ALL PRODUCT FEATURES

# RIDING GEAR



## OFF-ROAD RIDING JERSEYS

S-3XL | \$45.99

- Mesh ventilated panels for maximum airflow
- Elastic sleeves with non-restrictive cuffs

## OFF-ROAD RIDING GLOVES

S-3XL | \$32.99

- Adjustable wrist closure for a custom fit
- Silicon finger grips and neoprene knuckle protection

## YOUTH JERSEY

S-XL | \$34.99

- MULTICOLOR | 2860652
- BLUE | 2860651



**BLACK**  
JERSEY | 2860646  
GLOVE | 2860641

**BLUE/LIME**  
JERSEY | 2860647  
GLOVE | 2860642

**MULTICOLOR**  
JERSEY | 2860648  
GLOVE | 2860643

**NAVY/PINK**  
JERSEY | 2860649  
GLOVE | 2860644

**RED**  
JERSEY | 2860650  
GLOVE | 2860645

# TEKVEST®

ULTIMATE PROTECTION



**TEKVEST® SUPERSOFT**  
S-3XL | 2862190 | \$529.99

- Zip-off fleece collar diffuses rising body heat to reduce fogging
- Drop-tail design for extended coverage
- 2-stage pockets



**TEKVEST® FREESTYLE**  
S-3XL | 2862189 | \$429.99

- Strong, protective ultra high molecular weight panels cover shoulders
- Front and rear mesh panels promote cooling airflow



**TEKVEST® YOUTH**  
70-100 lbs | 2862191 | \$353.99

- Adjustable side straps and arm straps
- Strong, protective ultra high molecular weight panels cover shoulders

# COOLING SHIRTS

## MEN'S LONG SLEEVE COOLING SHIRT

S-3XL | 2860638 | \$58.99

## WOMEN'S LONG SLEEVE COOLING SHIRT

S-3XL | 2860640 | \$58.99



## FABRIC TECHNOLOGY DESIGNED TO KEEP YOU COOL

Cooling fabric designed with sun protection in mind. Our chemical-free fabric Coolcore® reduces the surface temperature on our cooling shirt up to 30%, so you don't overheat. It carries a 50 Ultraviolet Protection Factor rating, the highest attainable, blocking 98% of harmful UV rays.

## SHORT SLEEVE COOLING SHIRTS

- MEN'S**  
S-3XL | 2860634 | \$45.99
- WOMEN'S**  
S-3XL | 2860636 | \$45.99

# HEATED VEST



## HEATED VESTS

S-3XL | \$266.99

- NEW** WOMEN'S BLACK | 2861440
- NEW** MEN'S BLACK | 2861441

- Replacement / Spare Battery: 2869692
- Replacement Cord: 2869694

# RAIN SUIT



## RAIN JACKET

GRAY

S-3XL | 2869527 | \$129.99

## RAIN PANTS

GRAY

S-3XL | 2869528 | \$109.99

- 100% waterproof lightweight and packable nylon
- YKK® Zippers
- Rain jacket has removable hood

APPAREL & HELMETS

OUTWEAR & PROTECTION

LIFESTYLE & CAPS

CAMO & GIFTS

# HELMETS



RED/BLACK  
XS-4XL  
2861470



## [ALTITUDE]



BLACK  
XS-4XL  
2861469



BLACK/RED  
XS-4XL  
2861472



**\$532<sup>99</sup>**  
CARBON FIBER  
BLACK/LIME  
XS-4XL | 2861473

### **NEW** 509<sup>®</sup> ALTITUDE 2.0 HELMET

**\$399<sup>99</sup>**

Lightweight Design, performance-infused style and features with all-day comfort

#### SHELL

- Strong, lightweight construction of carbon fiber or fiber glass

#### WEIGHT

- Composite as low as 1,260g
- Carbon fiber as low as 1,150g

#### FEATURES

- Superior fit for all-day comfort
- Removable Pro Series breath box provides excellent ventilation and air flow
- One-piece eye-port creates draft-free seal with 509<sup>®</sup> goggles
- Magnetic Fidlock<sup>®</sup> chin-strap technology and integrated GoPro<sup>®</sup> mount
- DOT- and ECE 22.05-approved



## [TENACITY]



BLACK  
XS-2XL  
2861557



BLACK/GRAY  
XS-2XL  
2861558



BLACK/WHITE  
XS-2XL  
2861560



WHITE/RED  
XS-2XL  
2861561



PINK  
XS-2XL  
2861562

### **NEW** TENACITY 4.0 HELMET

**\$186<sup>99</sup>**

Combination of modern style and premium protection with incredible value

#### SHELL

- Shock-resistant, injection-molded thermoplastic

#### WEIGHT

- 1,500g

#### FEATURES

- Through-flow, full-helmet ventilation
- ProClip quick release chin strap allows you to fasten the chin strap in seconds
- Removable breath box
- Tool-less adjustable roost shield
- Removable, washable liner
- DOT- and ECE 22.05-approved

# GOGGLES



BLACK  
2868669

RED  
2868670

LIME  
2868671

BLUE  
2868667

### KINGPIN 509<sup>®</sup> DIRT GOGGLE

**\$74<sup>99</sup>**

Premium Materials, attractive price

#### FEATURES

- Oversized spherical lens delivers optimal peripheral vision
- Metal tear off posts provide strength and durability
- Quick-change technology allows you to run the best lens tint for conditions



ORANGE  
2868668

### TRAIL GOGGLE

**\$46<sup>99</sup>**

Clear Vision at a Great Value

#### FEATURES

- Offers a distortion-free view with anti-scratch, anti-fog and UV-blocking technology
- Large lens opening enables greater peripheral vision



BLACK  
2867917

# OUTERWEAR

**FORCE JACKET**

**WINDBREAKER JACKET**

**NEW**  
**FORCE JACKET** \$186<sup>99</sup>

Versatile, lightweight jacket ideal for layering or wearing as a casual jacket.

MEN'S | S-3XL | 2861432



**WOMEN'S**  
S-3XL | 2861433

**NEW**  
**WINDBREAKER JACKET** \$132<sup>99</sup>

Lightweight, windproof jacket that provides protection while riding.

- 100% polyester windproof fabric
- 3 external pockets allow for maximum storage

S-3XL | 2861541

**GRAY/BLUE**  
S-3XL | 2861439

**BLACK**  
S-3XL | 2861434

**NEW**  
**SOFTSHELL JACKET** \$172<sup>99</sup>

Lightweight performance that's surprisingly warm and perfect for everyday wear

- DWR prevents precipitation from saturating the jacket's exterior
- Three external and one internal pocket
- Lined with 280 grams of soft fleece for warmth
- Removable hood and underarm venting



**MAROON**  
S-3XL | 2861438

**BLACK**  
S-3XL | 2861437

**GRAY**  
S-3XL | 2861435

**BLACK/BLUE**  
S-3XL | 2861436

**WOMEN'S**

**MEN'S**

**FLANNEL JACKET**  
**BRONZE**  
S-3XL | 2860864

**WORK JACKET**  
**FOREST GREEN**  
S-3XL | 2860862

**FLANNEL JACKET** \$129<sup>99</sup>

**CHARCOAL**  
S-3XL | 2860865

This stylish flannel jacket is designed to keep you riding on brisk days. Soft yet durable brushed flannel with a Sherpa fleece lining offers excellent insulation without the bulkiness of a winter jacket.

**WORK JACKET** \$207<sup>99</sup>

This warm and rugged jacket was engineered to be tough enough for work yet stylish enough for play.

**External features:**

- Constructed of Nylon 6, a durable, tear-resistant non-stretch woven fabric
- Coated with Durable Water Repellency (DWR) to provide water-resistance in the elements
- Four external pockets for maximum gear storage

**Internal features:**

- 80 gram 3M® Thinsulate® for added warmth
- Built in action back for increased range of motion
- Internal zipper pocket
- Brushed flannel trim

**NEW**  
**BLACK** S-3XL | 2861608  
**GRAY** S-3XL | 2860863

# LAYERING

**TECH QUARTER ZIP**  
**PINK**  
S-3XL | 2861448

**NORTHSTAR MID LAYER**  
**BLACK/GRAY**  
S-3XL | 2869925

**NEW**  
**TECH QUARTER ZIP** \$79<sup>99</sup>

Excellent for ride layering, comfortable and stylish stand-alone.

**WOMEN'S**



**BLACK**  
S-3XL | 2861447

**MEN'S**



**BLUE**  
S-3XL | 2861443



**BLACK**  
S-3XL | 2861442

**NORTHSTAR MID LAYER** \$119<sup>99</sup>

Breathable fleece mid-layer is perfect for adding warmth or as a stand-alone shirt.



**NEW**  
**BLACK/RED**  
S-3XL | 2861445

APPAREL & HELMETS

OUTERWEAR & PROTECTION

LIFESTYLE & CAPS

CAMO & GIFTS



**NEW**  
**MEN'S ICON HOODIE**  
 S-3XL | \$72.99  
 BLACK | 2861496  
 GREEN | 2861495



**NEW**  
**WOMEN'S TECH HOODIE**  
 S-3XL | \$86.99  
 GRAY | 2861508  
 MAROON | 2861509



**POLARIS GENERAL HAT**  
 \$32.99  
 GRAY S/M | 2868748  
 GRAY L/XL | 2868749

**POLARIS GENERAL TEE**  
 S-3XL | \$32.99  
 GRAY | 2868767



**NEW**  
**BADGE TRUCKER HAT**  
 One-Size | \$32.99  
 GRAY | 2861531  
 NAVY | 2861532  
 BLACK | 2861533  
 PINK | 2861549  
 MAROON | 2861537



**NEW**  
**TONAL HAT**  
 L/XL | \$32.99  
 BLACK | 2861526  
 NAVY | 2861525



**NEW**  
**CORE HAT**  
 One-Size | \$32.99  
 NAVY | 2861523  
 BLACK | 2861524



**NEW**  
**CHECKERED HAT**  
 One-Size | \$32.99  
 NAVY | 2861520  
 GRAY | 2861521  
 BLACK | 2861522



**NEW**  
**MEN'S CREW SWEATSHIRT**  
 S-3XL | \$64.99  
 GREEN | 2861498  
 NAVY | 2861497



**NEW**  
**WOMEN'S ICON HOODIE**  
 S-3XL | \$72.99  
 MAROON | 2861507  
 BLACK/PINK | 2861506



**NEW**  
**WOMEN'S ALL-IN TEE**  
 S-3XL | \$32.99  
 BLACK | 2861598  
 OLIVE | 2861599



**NEW**  
**MEN'S PERFORMANCE LONG SLEEVE**  
 S-3XL | \$52.99  
 ROYAL | 2861589  
 GRAY | 2861588



**NEW**  
**MEN'S TECH HOODIE**  
 S-3XL | \$86.99  
 BLACK/BLUE | 2861494  
 GRAY | 2861493



**NEW**  
**WOMEN'S CHECKERED HOODIE**  
 S-3XL | \$52.99  
 BLACK | 2861609  
 BLUE | 2861610



**NEW**  
**MEN'S BACK GRAPHIC TEE**  
 S-3XL | \$32.99  
 GRAY | 2861568  
 NAVY | 2861569



**NEW**  
**MEN'S STAMP TEE**  
 S-3XL | \$32.99  
 GRAY | 2861565  
 GREEN | 2861564



**CAMO**

**NEW**

**STEALTH CAMO HAT**  
One-Size | \$32.99  
CAMO | 2861527



**NEW**

**NORTHSTAR MID LAYER**  
S-3XL | \$119.99  
CAMO | 2861542

**NEW**

**CAMO SOFTSHELL JACKET**  
S-3XL | \$172.99  
CAMO | 2861543



**CAMO POLY HOODIE**  
S-3XL | \$71.99  
BLACK | 2860718



**HUNTER CAMO HOODIE**  
S-3XL | \$67.99  
OLIVE | 2868716  
GRAY | 2860728



**CAMO FULL ZIP**  
S-3XL | \$79.99  
OLIVE | 2869590



**MEN'S CAMO TEE**  
S-3XL | \$32.99  
GRAY | 2860709  
BLACK | 2860710



**CAMO HOODIE**  
S-3XL | \$74.99  
WOMEN'S | 2867898  
MEN'S | 2867879



**CAMO TRUCKER HAT**  
One-Size | \$32.99  
BLACK | 2860613  
PINK | 2860614

**GIFTS & BRANDED MERCHANDISE**

**POLARIS STEEL SIGN (14" x 36")**  
2860868 | \$168.99

**PINT GLASS (SET OF 2)**  
2860815 | \$25.99

**POLARIS WOODEN COASTERS WITH BOTTLE OPENER**  
2860869 | \$32.99



**DRINKWARE**



**PREMIUM COOZIE**  
2860829 | \$10.99



**NEW**  
17oz WATER BOTTLE  
2861611 | \$32.99



**NEW**  
12oz CAMPER MUG  
2861612 | \$39.99



**NEW**  
15oz CAMPFIRE MUG  
2861613 | \$26.99

**RECREATION/GARAGE**



**NEW**  
EVENT FOLDING CHAIR  
2861617 | \$59.99



**NEW**  
FOLDING TABLE  
2861620 | \$66.99



**POLARIS WOOD SIGN (10.5" x 24")**  
2860866 | \$97.99



**NEW**  
NECK GAITERS  
One-Size | \$16.99  
CAMO | 2861948  
BLACK | 2861953

**COLLECTIBLES**



**NEW**  
KEYCHAIN  
2861614 | \$8.99



**NEW**  
LEATHER KEYCHAIN  
2861616 | \$8.99



**NEW**  
POLARIS LEATHER LOOP KEY CHAIN  
2861615 | \$19.99



**BOTTLE OPENER**  
2860818 | \$19.99

APPAREL & HELMETS

OUTWEAR & PROTECTION

LIFESTYLE & CAPS

CAMO & GIFTS

# FIND YOUR NEXT ADVENTURE



## BUILD THE MACHINE TO TAKE YOU THERE

Customize your GENERAL with exactly what you need to ride comfortably and explore farther than you've ever gone before.



**STEP 1**  
CHOOSE  
MODEL



**STEP 2**  
CHOOSE  
TRIM

**STEP 3**  
CHOOSE  
COLOR

**STEP 4**  
CHOOSE  
ACCESSORIES

### EXPERIENCE OFF-ROAD LUXURY

- Windshield & Rear Panel P. 08
- Doors P. 10
- Roof P. 12
- Cab Comfort P. 16

### NEXT LEVEL VERSATILITY

- Storage P. 14
- Lighting P. 24
- Wheels & Tires P. 26
- Winches P. 34

### THE RIGHT STUFF TO MAINTAIN YOUR GENERAL

- Oil & Lubricants P. 38
- Maintenance P. 36

### EVERYTHING YOU NEED TO GEAR UP

- Apparel P. 54
- Helmets P. 56

**BUILD YOUR OWN AT**  
**[POLARIS.com/GENERAL](https://POLARIS.com/GENERAL)**

Warning: Polaris off-road vehicles can be hazardous to operate and are not intended for on-road use. Driver must be at least 16 years old with a valid driver's license to operate. All riders should always wear helmets, eye protection and protective clothing and foot wear. Read, understand and follow your owner's manual. Ride within the limits of your own abilities and never engage in stunt or exhibition driving. Never ride under the influence of drugs or alcohol. All riders should take a safety training course. Call 800-342-3764 for additional information.  
UNLESS NOTED, TRADEMARKS ARE THE PROPERTY OF POLARIS INDUSTRIES INC. 3M® and Thinsulate® are registered trademarks of 3M Company. 509® is a registered trademark of Teton Outfitters, LLC. Apple® is a registered trademark of Apple Inc. App Store® is a registered trademark of Apple Inc. BatteryMinder® is a registered trademark of VDC Electronics Inc. Bluetooth® is a registered trademark of Bluetooth Sig, Inc. Caliber® is a registered trademark of Caliber, Inc. Camoplast® is a registered trademark of Camoplast Solideal Inc. CAMSO® is a registered trademark of Arctic Investments S.A. Can-Am® and COMMANDER® are registered trademarks of Bombardier Recreational Products Inc. COOLCORE® is a registered trademark of COOLCORE LLC. Fidlock® is a registered trademark of Fidlock GmbH. FOX® is a registered trademark of Fox Factory Inc. Google Play® is a registered trademark of Google, Inc. GoPro® is a registered trademark of GoPro, Inc. Kolpin® is a registered trademark of Polaris Industries, Inc. Maxxis® is a registered trademark of Cheng Shin Rubber Ind. Co., Ltd. Pandora® is a registered trademark of Pandora Media, LLC. Rigid® is a trademark of JST Performance, LLC d/b/a Rigid Industries. Rockford Fosgate® is a registered trademark of Rockford Corporation. TEKVEST® is a registered trademark of 1191876 ONTARIO INC. Tiger Drylock® is a registered trademark of TIGER COATINGS GMBH & CO. Yeti® is a registered trademark of Yeti Coolers, LLC. YKK® is a registered trademark of YKK Corporation. YouTube® is a registered trademark of Google, Inc. Prices, Fitment and Availability are subject to change at any moment. COPYRIGHT © 2020 POLARIS INDUSTRIES INC. ALL RIGHTS RESERVED.

# ELEVATE YOUR **ADVENTURE**



CONNECT ONLINE  
SEARCH "PolarisORV"



## **BUILD YOUR DREAM MACHINE & EXPLORE FARTHER**

**1** CHOOSE  
MODEL

**2** CHOOSE  
TRIM

**3** CHOOSE  
COLOR

**4** CHOOSE  
ACCESSORIES

**VISIT POLARIS.COM/GENERAL**

TO SEE ALL YOUR OPTIONS & ACCESSORIES  
ON YOUR NEW MACHINE FROM EVERY ANGLE!



# **POLARIS**

MY21 GENERAL APP ACC CAN • 9948063

January 2021