

CANADA VERSION

POLARIS **RANGER**

POP

ACCESSORIES + APPAREL



HARDEST WORKING. SMOOTHEST RIDING.

For the past two decades, RANGER has set the standard through unrivaled strength, unmatched capability and next-level comfort, making it the number one utility side-by-side for over 10-years running.

2021 LINEUP

SEE THE FULL LINEUP AT POLARIS.COM/RANGER

2021 PACKAGES & LIMITED EDITIONS

P. 2

SEE P. 2-5 FOR DETAILS

XP 1000 & 1000 3-SEAT & CREW

P. 16



570 FULL-SIZE 3-SEAT & CREW

P. 64



570/500 MID-SIZE 2-SEAT & CREW

P. 66



RANGER 150 YOUTH

P. 76



CONTENTS

2021 PACKAGES & LIMITED EDITIONS 2

XP 1000 & 1000 3-SEAT & CREW 16

ROOFS	18
WINDSHIELDS	20
REAR PANELS	22
DOORS	24
CAB COMFORT & CONVENIENCE	26
ELECTRICAL ACCESSORIES	28
WINCHES	30
PROTECTION	32
TECHNOLOGY	34
STORAGE	38

COMMON ACCESSORIES 42

COOLERS	42
HUNT	44
COLD WEATHER	46
PLOWS	48
LIGHTING	52
WHEELS & TIRES	54

570 FULL-SIZE 3-SEAT & CREW 64

570/500 MID-SIZE 2-SEAT & CREW 66

ROOFS & DOORS	68
WINDSHIELDS & REAR PANELS	70
CONVENIENCE & PROTECTION	72
WINCHES	73
STORAGE	74

RANGER 150 YOUTH 76

PARTS & GARAGE 78

MAINTENANCE	78
OIL & LUBRICANTS	80
MAINTENANCE FLUIDS	82
SERVICE PARTS	84
HO PARTS	86
BATTERIES & TIRE SEALANT	88
VEHICLE CARE & TRAILERING	90
POLARIS POWER	92

APPAREL & HELMETS 96

OUTERWEAR & PROTECTION	96
LIFESTYLE & CAPS	102
CAMO & GIFTS	104

RANGER XP 1000 NORTHSTAR

OFF-ROAD CLIMATE CONTROL

Be in control of your comfort with standard Pro Shield cab system, heat, air conditioning, and more. Polaris RANGER XP 1000 NorthStar helps you finish whatever task you set out to do, no matter the weather conditions. Take your NorthStar to the next level with hundreds of accessories to choose based on your riding needs.



DO MORE:

PROTECTION

Protect the front and rear of your RANGER from whatever obstacles you may encounter off-road. P. 32

AUDIO

Customize your audio system to listen to your favorite songs on the trails. P. 34

LIGHTING

Extend the day and work longer with easy-to-install powerful lighting. P. 52

STORAGE

Leave nothing behind with the limitless customization of Lock & Ride storage. P. 38

WHEELS & TIRES

Select wheels and tires custom built for your riding style and the terrain you ride in. P. 54

UPGRADE YOUR NORTHSTAR

RANGER XP 1000 FAMILY

You've got the essentials straight from the factory—but why stop there? Get the most out of your NorthStar with additional Polaris Engineered accessories to fit your riding needs. Add the **MUST HAVES** for top-selling accessories or **UTILITY** to optimize for the toughest outdoor jobs. Or, pick and choose your favorite accessories to make it your own.



NORTHSTAR PREMIUM COMES STANDARD WITH:

Heating & Air Conditioning HVAC System
Polaris Pro 4,500 lb. Winch
Sport Roof with Premium Liner & Dome Light
Lock & Ride Glass Windshield with Wiper/Washer System
Lock & Ride Glass Rear Panel
Premium Manual Crank Window Doors



NORTHSTAR ULTIMATE COMES STANDARD WITH:

Heating and Air Conditioning HVAC System
Ride Command 7" Infotainment System
Pro Shield Full Glass Tip-Out Windshield with Wiper/Washer System
Power Window Doors
Polaris Pro 4,500 lb. Winch
Sport Roof with Premium Liner & Dome Light
Lock & Ride Glass Panel
LED Headlights
29" Tires

	PART NUMBER	PRODUCT NAME	PAGE NUMBER	PRICE
MUST HAVES	2882531	Upper Front Brushguard	P. 32	\$339 ⁹⁹
	2882529	Rear Brushguard	P. 32	\$269 ⁹⁹
	2882690	Front Hood Storage Rack	P. 38	\$469 ⁹⁹
	2883279	Lock & Ride Storage Box	P. 41	\$439 ⁹⁹
	2883230	Polaris PULSE Wiring Harness - 1 Light Bar	P. 29	\$114 ⁹⁹
	2882077	Pro Armor 33" - Combo LED Light Bar	P. 53	\$509 ⁹⁹
				\$2,144⁹⁹
UTILITY	2883265	Work Beacon LED Light	P. 27	\$309 ⁹⁹
	2883230	Polaris PULSE Wiring Harness - 1 Light Bar	P. 29	\$114 ⁹⁹
	2882752	Lock & Ride Bed Extender/Divider	P. 38	\$269 ⁹⁹
	2884141	Electronic Cargo Box Lift	P. 40	\$799 ⁹⁹
	2882384	Pro Armor Wheel & Tire Set: Buckle & Harvester, 27R14	P. 60	\$1,599 ⁹⁹
				PLUS \$3,094⁹⁵

TAKE ADVANTAGE

of your off-road climate control with winter and plow accessories on P. 48



TAKE YOUR 2021 RANGER PACKAGE TO THE NEXT LEVEL



You've already elevated your off-road experience with an industry-exclusive package. Don't stop there! Customize your experience by adding key accessories.

WINTER PREP PACKAGE

RANGER 1000

MOST POPULAR ADD-ONS

RANGER PRO SHIELD	
CAB SYSTEM	P. 12
PROTECTION	P. 32
COLD WEATHER	P. 46
LIGHTING	P. 52
WHEELS & TIRES	P. 54



RIDE COMMAND PACKAGE

RANGER XP 1000

MOST POPULAR ADD-ONS

RANGER PRO SHIELD	
CAB SYSTEM	P. 12
STORAGE	P. 38
COLD WEATHER	P. 46
LIGHTING	P. 52



RIDECMD

KEEP YOUR
STANDARDS
HIGH. WE DO.

DESIGNED



Designed by the same people who designed your vehicle.

TESTED



Extensively tested in the field so you ride with 100% confidence.

TRUSTED



ACCESSORIES
BACKED BY A



WARRANTY

65 years in the business. The #1 name in Off-Road.

WE HOLD OUR
PARTNERS TO THE
SAME STANDARDS



WHEELS, TIRES & LIGHTING DESIGNED WITH POLARIS TO MAXIMIZE PERFORMANCE
P. 52 LIGHTING, P. 54 TIRES & WHEELS



IGNITE AND FUEL YOUR PASSION FOR PRECISE QUALITY SOUND REPRODUCTION
P. 34



PRODUCTS SO GOOD THEY REPLACE OR REPAIR THEM FOR LIFE
P. 52



MAKING PRODUCTS FOR AVID SPORTSMEN SINCE 1943
P. 44

RANGER XP 1000 & 1000

#1 TRUSTED UTV

BY FARMERS, RANCHERS, HUNTERS
AND HOMEOWNERS FOR MORE THAN A DECADE.

INDUSTRY-LEADING ACCESSORIES
ENGINEERED TO DO MORE
FOR EVERY KIND OF JOB BIG OR SMALL

INDUSTRY-LEADING COMFORT

LEVERAGE THE FULL CAPABILITIES
OF YOUR MACHINE YEAR-ROUND.



SUPERIOR INTEGRATION

MAKE WORK EASIER WITH YOUR VEHICLE BUILT
TO ADD ESSENTIAL ACCESSORIES FOR ANY JOB.



DO MORE

TACKLE ANY JOB AND LEAVE
NOTHING BEHIND.

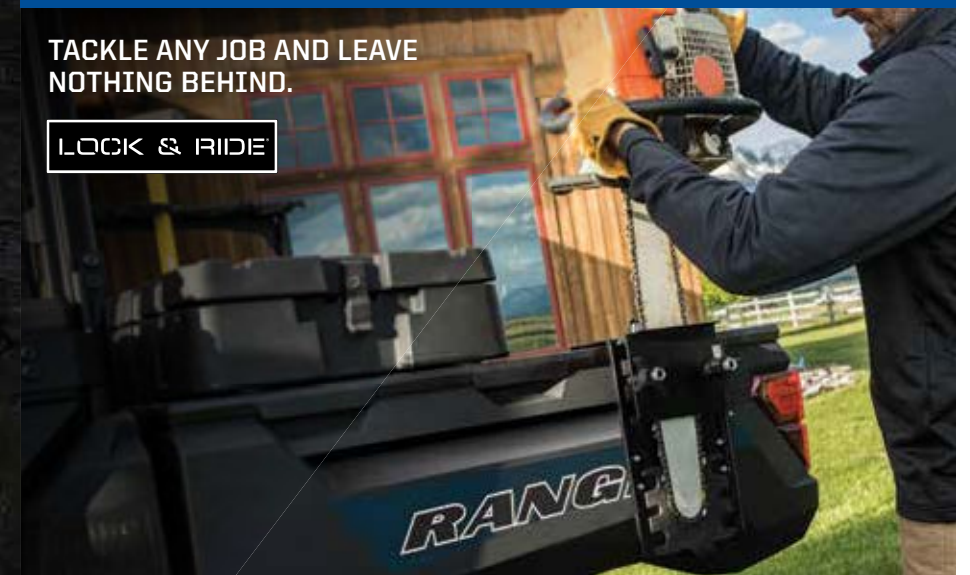

ENGINEERED FOR MORE

POLARIS
ENGINEERED

HARDEST WORKING, SMOOTHEST RIDING. RANGER is the world's most trusted, most capable, work partner in the world. Developed and tested along with the vehicle, Polaris Engineered Accessories are designed for seamless integration and simple installation to get more done, year-round.

SUPERIOR INTEGRATION

PRO PRO HEAVY DUTY SERIES

WINCHES

P. 30

INTEGRATED WINCH MOUNT & PRE-WIRED

Designated mounting points and pre-wired contactors ensure a perfect fit and the strongest place to attach the Polaris Engineered winch - the most dependable winch for your RANGER. With wiring built right into the vehicle, we made this the easiest RANGER winch ever made to install.

#GLACIER

P. 48

PLOW SYSTEM

INTEGRATED PLOW MOUNT

The attachment points for the best-in-class Glacier® Plow System are integrated right at the factory and feature an innovative drive-up and go installation process.

POLARIS PULSE
Electrical System

P. 28

PLUG & PLAY ELECTRICAL

A revolution in electrical accessory integration, the Polaris PULSE Electrical System allows for a simple Plug & Play approach for adding power to Polaris Engineered Accessories.



DO MORE

LOCK & RIDE

P. 38

CARGO BOX VERSATILITY

Lock & Ride mounting locations allow for limitless customization to let you work the way you want.

INDUSTRY-LEADING COMFORT

OUR BEST SEALING CAB

With the profile channels engineered into the roll cage, body plastics molded to seal and cab accessories designed to keep the elements out, the RANGER Pro Shield Cab System offers a new level of interior comfort.

RANGER
PRO SHIELD
CAB SYSTEM

P. 12



INDUSTRY-LEADING COMFORT

Look for the RANGER PRO SHIELD Logo for the 4 components to customize your RANGER with our best sealing cab.



ULTIMATE CLARITY

Tempered safety glass, clear to see through and shatterproof.

COLOR MATCHED

Key color matched accent panels available for all XP 1000 & 1000 models.

PROTECTION

Inner & outer shells are made from high-quality, injection-molded plastics using a state-of-the-art process to shield from the elements and more.

EASY-ON/OFF HINGES

Once installed, the pin system allows for easy on & off.

DURABLE CONSTRUCTION

With a 2.5 cm tube steel frame these doors can handle the rigors of the off-road.



A FRAME DESIGNED FOR A CAB

All RANGER cab components fit perfectly to the contours of the RANGER XP 1000 and RANGER 1000 profile tube cab frame, floor and body panels, allowing for a 360° gasket seal, seamless fit and installation providing unprecedented protection from the elements.

AVAILABLE FOR
RANGER XP 1000
& RANGER 1000

1 CHOOSE YOUR ROOF
P. 18

2 CHOOSE YOUR WINDSHIELD
P. 20

3 CHOOSE YOUR REAR PANEL
P. 22

4 CHOOSE YOUR DOORS
P. 24

NEXT-LEVEL INTERIOR COMFORT

Add a new level of interior comfort by adding a RANGER Pro Shield Cab System – tested to military standards. Seal out dust, water, and noise by selecting a roof, windshield, rear panel, and set of doors. Extend your work day or trail ride while protecting you and your passengers from the elements.



RAIN

Rest assured that you and your passengers will stay dry and comfortable on rainy days



SNOW

Keep cold wind and snow out in winter months

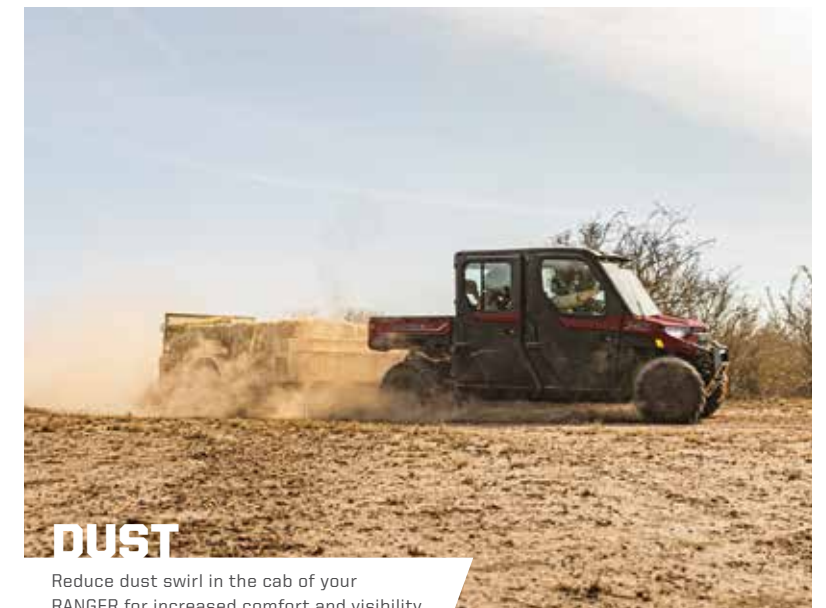

DUST

Reduce dust swirl in the cab of your RANGER for increased comfort and visibility

SUPERIOR INTEGRATION

Right from the factory, your vehicle is built to make essential accessories like winches and plows easy to use day-in and day-out. Mounting brackets are designed into the oversized factory bumper and wiring is routed securely and properly. When it comes to RANGER, Polaris Engineered Accessories make work easier so you can get more done.

PRO PRO HEAVY DUTY SERIES

HID HEAVY DUTY SERIES



WINCHES P. 30

POLARIS ENGINEERED WINCH FEATURES



Tested **1,200+** pulls at max load, it works when you need it to



Built to withstand **-20°F** temperatures



Sealed motor & heavy duty gears **OPERATE FULLY SUBMERGED UNDERWATER**



MILITARY tested & approved



PRE-WIRED CHASSIS

Dash mounted controls and wiring are installed at the factory. Mount the winch, connect the wires and trust that everything is routed safely, securely, and properly.

NO NEED TO CUT PANELS

FULLY INTEGRATED MOUNT & WIRING

GLACIER[®] PLOW SYSTEM



P. 48

GLACIER[®] FEATURES



To install the plow, simply lift the mount lock handle and pull forward



No loss of factory ground clearance when not plowing



Don't have to crawl under the machine to release the plow blade from the vehicle



No trimming of vehicle plastic or fascia required to mount plow or winch

ANGLE YOUR BLADE
RIGHT FROM YOUR SEAT

25°
LEFT AND RIGHT



RANGER 1000 & XP 1000

MAKE IT YOURS.

WORK HARD AND GET IT DONE with Polaris Engineered Accessories for your RANGER. Start with the ultimate in all-season performance and comfort with the best cab components in the industry. Find everything you need to outfit your RANGER for the task at hand.



RANGER XP 1000 / RANGER 1000 RANCH

2883265	Work Beacon LED Light	P. 27
2882752	LOCK & RIDE Bed Extender/Divider	P. 38
2882910	Dual Bin Under Seat Dry Storage Box	P. 26
2882753	8-Vent Heater & Defrost System	P. 26
2883121	Rigid® SR-Series 10" Spot LED Light	P. 52
2882710	Polaris PRO HD 6,000 lb. Winch with Rapid Rope Recovery	P. 31
2882531	Upper Front Brushguard	P. 32
2881531	LOCK & RIDE Tip-Down Headache Rack	P. 38
2882529	Rear Brushguard	P. 32
2883148	Pro Armor Wheel & Tire Set: Dual Threat & Buckle - Accent	P. 61



RANGER XP 1000 / RANGER 1000 BIG GAME

2883265	Work Beacon LED Light	P. 27
2884107	LOCK & RIDE Kolpin Rhino Grip PRO	P. 45
2882077	Pro Armor 33" - Combo LED Light Bar	P. 53
2882753	8-Vent Heater & Defrost System	P. 26
2882710	Polaris PRO HD 6,000 lb. Winch with Rapid Rope Recovery	P. 31
2882690	Front Hood Storage Rack	P. 38
2883157	Pro Armor Wheel & Tire Set: Attack 2.0 & Flare - Matte Black	P. 60



RANGER XP 1000 / RANGER 1000 WATERFOWL

2883265	Work Beacon LED Light	P. 27
2883263	In-Cab Gun Mount	P. 45
2884271	Pro Armor Wheel & Tire Set: Mud XC & Shackle - Matte Black	P. 60
2882076	Pro Armor 2"x2" Cube - LED Spot Light (x2)	P. 52
2882711	Polaris PRO HD 4,500 lb. Winch with Rapid Rope Recovery	P. 31
2882690	Front Hood Storage Rack	P. 38
2882177	LOCK & RIDE CargoMax System	P. 38



RANGER XP 1000 / RANGER 1000 CRAFTSMAN

2881485	Cargo Bed Mat	P. 40
2879354	LOCK & RIDE Chainsaw Mount	P. 40
2882752	LOCK & RIDE Bed Extender/Divider	P. 38
2882077	Pro Armor 33" - Combo LED Light Bar	P. 53
2882711	Polaris PRO HD 4,500 lb. Winch with Rapid Rope Recovery	P. 31
2877033	LOCK & RIDE Storage Box	P. 41
2882384	Wheel & Tire Set: Pro Armor Harvester & Buckle - Matte Black	P. 60
2881533	LOCK & RIDE Tool Rack	P. 41

SHOP ALL RANGER ACCESSORIES AT [POLARIS.COM/ShopRANGER](https://www.polaris.com/ShopRANGER)

COMPLETE LIGHTING WITH REQUIRED LIGHT BAR HARNESES, SEE P. 52-53

3-SEAT & CREW

1000 / XP 1000

ROOFS

WINDSHIELDS

REAR PANELS

DOORS

CAB COMFORT

ELECTRICAL

WINCHES

PROTECTION

TECHNOLOGY

STORAGE

ROOFS

POLY VS STEEL*

- Water run-off
- Polaris PULSE Plug & Play
- Liner ready
- Lightweight

- Heavy duty/durable
- Low profile
- Unique style



PREMIUM FINISH & QUIETER RIDE



SEALED COVERAGE

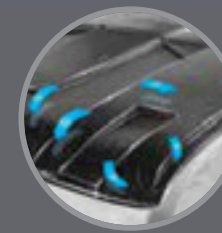

REDUCE STANDING WATER

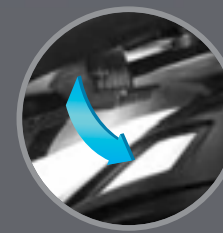

EASY AND FAST INSTALLATION

TO SHIELD AGAINST DRIVING RAIN OR THE BLISTERING SUN, a roof is the first must-have of the Polaris Engineered cab components. Choose from poly or steel, and get on your way with protective peace of mind.



PREMIUM & SPORT ROOF FEATURES

SEE AUDIO OPTIONS P. 34



* PREMIUM AND SPORT FEATURES NOT AVAILABLE ON STEEL ROOFS

MULTI-FUNCTION LIGHT READY

WINDSHIELD WIPER & WASHER SYSTEM WIRING READY

SOUND ABSORBING LINER

POLARIS PULSE INTEGRATION

AUDIO READY

POLY

Lightweight, durable and impact-resistant. A poly roof can take the abuse of a tough trail and still protect.

PREMIUM ROOF - POLY

» POLARIS PURSUIT CAMO • 2882913 • \$929⁹⁹

» TOP SELLER BLACK • 2882912 • \$734⁹⁹

XP 1000 '17-21, 1000 '20-21

INCLUDES ROOF LINER



SPORT ROOF - POLY TOP SELLER

» BLACK • 2882911 • \$454⁹⁹

XP 1000 '17-21, 1000 '20-21



LINERS

Get a touch of premium comfort, reduce cab noise and hide wiring. Included with Premium Poly Roofs.

PREMIUM ROOF LINER

» 2882914 • \$269⁹⁹

XP 1000 '17-21, 1000 '20-21

WORKS WITH 2882911, 2882912, 2882913



PREMIUM ROOF CREW - POLY

» POLARIS PURSUIT CAMO • 2883277 • \$1,599⁹⁹

CREW XP 1000 '17-21, CREW 1000 '20-21

ROOF LINER INCLUDED WITH CAMO



SPORT ROOF CREW - POLY TOP SELLER

» BLACK • 2883274 • \$709⁹⁹

CREW XP 1000 '17-21, CREW 1000 '20-21



PREMIUM ROOF LINER - CREW

» 2883457 • \$339⁹⁹

CREW XP 1000 '17-21, CREW 1000 '20-21



POLARIS PULSE PLUG & PLAY

STEEL ROOFS NOT COMPATIBLE WITH OVERHEAD PULSE

ADD POWER TO PREMIUM & SPORT ROOFS P. 28

STEEL

For the ultimate in strength and protection.

HD ROOF - STEEL

» 2879881 • \$929⁹⁹

XP 1000 '17-21, 1000 '20-21

NOT COMPATIBLE WITH ROOF PULSE SYSTEM

ROOF LINER INCLUDED

HD ROOF CREW - STEEL

» 2880334 • \$1,209⁹⁹

CREW XP 1000 '17-21, CREW 1000 '20-21

NOT COMPATIBLE WITH PULSE BAR



3-SEAT & CREW

1000 / XP 1000

ROOFS

WINDSHIELDS

REAR PANELS

DOORS

CAB COMFORT

ELECTRICAL

WINCHES

PROTECTION

TECHNOLOGY

STORAGE

WINDSHIELDS

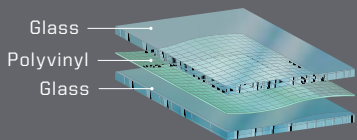

GLASS VS POLY

- Superior optical clarity (automotive level)
- Scratch-resistant
- Curved to fit, seals tight
- Cold weather/heavy duty
- Wiper ready

- Lightweight, flexible, easy to store/remove
- Impact-resistant
- 360° seal keeps out rain and dust

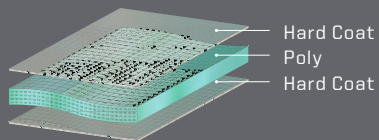

LOCK & RIDE
EASY AND FAST
INSTALLATION

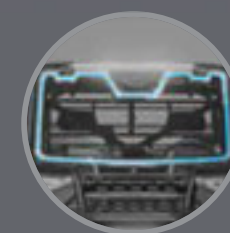

AIRTIGHT GASKET SEAL

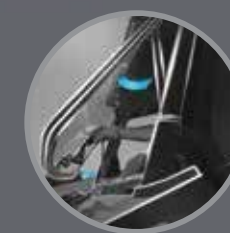

MULTI-FUNCTION FEATURES



HARD COAT POLY // 30X MORE SCRATCH-RESISTANT



LOCK & RIDE
FULL WINDSHIELD VENTED - HARD COAT POLY TOP SELLER

- Frameless design for maximum visibility
 - Added vents for airflow on a hot day or defrosting on a cold day
 - Requires Wiper Install Kit 2207624
- » 2883266 • \$779⁹⁹
XP 1000 '17-21, CREW XP 1000 '17-21, CREW 1000 '20-21, 1000 '20-21



LOCK & RIDE
FULL WINDSHIELD - HARD COAT POLY TOP SELLER

- Frameless design for maximum visibility
 - Requires Wiper Install Kit 2207624
- » 2883300 • \$669⁹⁹
XP 1000 '17-21, CREW XP 1000 '17-21, CREW 1000 '20-21, 1000 '20-21



FLIP-DOWN WINDSHIELD - HARD COAT POLY TOP SELLER

- Two venting options: fully sealed, flip-down or remove upper half for some protection with maximum ventilation
- » 2884139 • \$739⁹⁹
XP 1000 '18-21, CREW XP 1000 '19-21, CREW 1000 '20-21, 1000 '20-21



NEW **LOCK & RIDE**
FULL TIP-OUT WINDSHIELD - GLASS

- Tip-out design offers 3 positions - open, closed and vented while featuring a gas strut that assists in easy windshield opening and closing
 - Scratch-resistant automotive-style curved glass that provides interior sound dampening and optimized visibility
 - Bolt-on design to install directly on the cab frame
- » 2889031 • \$1,609⁹⁹
XP 1000 '18-21, CREW XP 1000 '19-21, CREW 1000 '20-21, 1000 '20-21



NEW **LOCK & RIDE**
FULL GLASS WINDSHIELD - CLEAR

- Scratch-resistant, curved laminate safety glass that protects against wind, rain and other hazardous debris
 - UV-blocking interlayer and 360 degree gasket seal
 - Seal Kit included
- » 2889030 • \$969⁹⁹
XP 1000 '17-21, CREW XP 1000 '17-21, CREW 1000 '20-21, 1000 '20-21



LOCK & RIDE
FULL WINDSHIELD - POLY TOP SELLER

- Frameless design for maximum visibility
- » 2883278 • \$539⁹⁹
XP 1000 '17-21, CREW XP 1000 '17-21, CREW 1000 '20-21, 1000 '20-21



LOCK & RIDE
HALF WINDSHIELD - POLY TOP SELLER

- Deflects air flow from straight on, but still provides air flow in the cab
- » 2883301 • \$269⁹⁹
XP 1000 '17-21, CREW XP 1000 '17-21, CREW 1000 '20-21, 1000 '20-21



ADD ALL-WEATHER VISIBILITY
WINDSHIELD WIPER & WASHER SYSTEM
P. 26

HARD COAT POLY WINDSHIELD WIPER & WASHER MOUNTING BRACKET

- Required to use wiper on 2883266 or 2883300
- » 2207624 • \$74⁹⁹
XP 1000 '17-21, CREW XP 1000 '17-21, CREW 1000 '20-21, 1000 '20-21



REDUCE IN-CAB DUST SWIRL BY ADDING A REAR PANEL
SEE P. 22

3-SEAT & CREW

1000 / XP 1000

ROOFS

WINDSHIELDS

REAR PANELS

DOORS

CAB COMFORT

ELECTRICAL

WINCHES

PROTECTION

TECHNOLOGY

STORAGE

REAR PANELS

POLARIS ENGINEERED ADVANTAGES

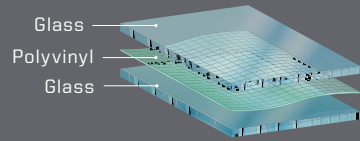

GLASS VS POLY

- Superior optical clarity (automotive level)
- Scratch-resistant
- Curved to fit, seals tight
- Cold weather/heavy duty

- Lightweight, flexible, easy to store/remove
- Impact-resistant
- Tight seal keeps out rain and dust

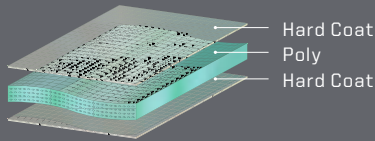

LOCK & RIDE
EASY AND FAST INSTALLATION

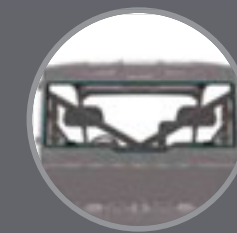

AIRTIGHT GASKET SEAL

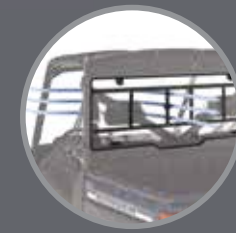

VENTING OPTIONS



REDUCE IN-CAB DUST SWIRL BY ADDING A REAR PANEL
With a windshield and roof installed, turbulent air develops behind the cab. Add a rear panel to reduce dust intrusion from this swirl.

HARD COAT POLY // 30X MORE SCRATCH-RESISTANT

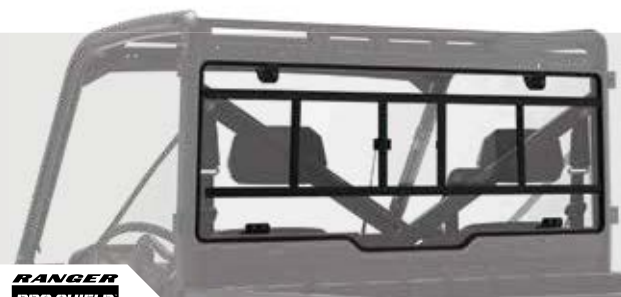

RANGER PRO SHIELD

LOCK & RIDE
REAR PANEL - SLIDING GLASS

- Sliding window provides ventilation, cab comfort and access to cargo in rear box
- » 2879015 • \$929⁹⁹
- XP 1000 '17-21, CREW XP 1000 '17-21, CREW 1000 '20-21, 1000 '20-21



RANGER PRO SHIELD

LOCK & RIDE
REAR PANEL - GLASS TOP SELLER

- » 2879013 • \$519⁹⁹
- XP 1000 '17-21, CREW XP 1000 '17-21, CREW 1000 '20-21, 1000 '20-21



RANGER PRO SHIELD

LOCK & RIDE
REAR PANEL - POLY POLARIS PURSUIT CAMO

- Strong, thick polycarbonate provides outstanding impact and scratch resistance
- Installs in contours of cab frame with 360° gasketing for outstanding protection, comfort, fit and finish
- Dot matrix screen printing allows for rear visibility
- » 2883774 • \$539⁹⁹
- XP 1000 '17-21, CREW XP 1000 '17-21, CREW 1000 '20-21, 1000 '20-21



RANGER PRO SHIELD

LOCK & RIDE
REAR PANEL - POLY - CLEAR TOP SELLER

- Strong, thick polycarbonate provides outstanding impact and scratch resistance
- Installs in contours of cab frame with 360° gasketing for outstanding protection, comfort, fit and finish
- » 2883773 • \$469⁹⁹
- XP 1000 '17-21, CREW XP 1000 '17-21, CREW 1000 '20-21, 1000 '20-21

3-SEAT & CREW

1000 / XP 1000

ROOFS

WINDSHIELDS

REAR PANELS

DOORS

CAB COMFORT

ELECTRICAL

WINCHES

PROTECTION

TECHNOLOGY

STORAGE

CAB COMFORT & CONVENIENCE



8-VENT HEATER & DEFROST SYSTEM

- Easily control the climate inside your cab in any season
- Helps defrost windshields and keeps you warm or cool
- Heat and fan dash-mounted controls
- Manual vents

» **TOP SELLER** 2882753 • \$1,289⁹⁹ **XP 1000 ONLY**

XP 1000 '18-21, CREW XP 1000 '19-21

» 2884066 • \$1,289⁹⁹ **1000 ONLY**

1000 '20-21, CREW 1000 '20-21
NEED ADAPTER: 2884163 ON CREW 1000

» **CREW HEATER ADAPTER KIT** **1000 ONLY**
2884163 • \$129⁹⁹

CREW 1000 '20-21



WINDSHIELD WIPER & WASHER SYSTEM

» 2883974 • \$679⁹⁹
XP 1000 '18-21, CREW XP 1000 '19-21,
CREW 1000 '20-21, 1000 '20-21
REQUIRES MOUNT KIT 2207624 FOR POLY WINDSHIELDS

HARD COAT POLY WINDSHIELD WIPER & WASHER SYSTEM MOUNTING BRACKET

» 2207624 • \$74⁹⁹
XP1000 '17-21, CREW XP 1000 '17-21,
CREW 1000 '20-21, 1000 '20-21
REQUIRED TO USE WIPER ON 2883266 OR 2883300

UNDER SEAT DRY STORAGE

» 2882910 • \$269⁹⁹ **XP 1000 ONLY**
XP 1000 '18-21, CREW XP 1000 '19-21
WILL NOT WORK WITH SUBWOOFER 2882890



FLOOR MATS - 3 SEAT

» 2882780 • \$169⁹⁹ **XP 1000 ONLY**
XP 1000 '18-21, CREW XP 1000 '19-21
CREW: FITS FRONT SEATS ONLY

» 2884247 • \$164⁹⁹ **1000 ONLY**
1000 '20-21, CREW 1000 '20-21
CREW: FITS FRONT SEATS ONLY

CAB SEAL SYSTEM - 3 SEAT

• Included in all Premium and Poly Doors

» 2883253 • \$134⁹⁹
XP 1000 '18-21, CREW XP 1000 '19-21,
CREW 1000 '20-21, 1000 '20-21

NOISE REDUCTION SYSTEM

» 2883489 • \$359⁹⁹
XP 1000 '18-21, CREW XP 1000 '19-21, CREW 1000 '20-21, 1000 '20-21
DESIGNED TO ATTACH TO THE REAR CLOSURE PANEL OF YOUR RANGER CAB, THE SOUND ABSORBING MATERIAL REDUCES UNWANTED NOISE FOR A QUIETER CAB



MULTI-FUNCTION CAB LIGHT

- LED dome light provides white, red, green and blue lighting options
- Battery-operated. Recharges when the vehicle is on
- Can be removed to use as a flashlight in and around your vehicle

- Red light is great for reading maps
- Green light is perfect for navigating in the dark
- Blue light is ideal for night riding

» 2882871 • \$134⁹⁹

XP 1000 '18-21, CREW XP 1000 '19-21, CREW 1000 '20-21, 1000 '20-21
REQUIRES ROOF PULSE: 2882904

REMOTE GARAGE DOOR OPENER BY HOMELINK®

- HomeLink® technology allows you to control up to two garage doors

» 2882892 • \$209⁹⁹

XP 1000 '18-21, CREW XP 1000 '19-21,
CREW 1000 '20-21, 1000 '20-21



POLARIS RANGER XP FULL-SIZE SEATSAVER - SPLIT BENCH SEAT

- Covers the back and bottom of seat

» POLARIS PURSUIT CAMO • 2883244-587 • \$299⁹⁹

» CARHARTT® BROWN • 2883244-218 • \$269⁹⁹

» CARHARTT® GRAVEL • 2883244-458 • \$269⁹⁹

XP 1000 '18-21, CREW XP 1000 '19-21
CREW: FITS FRONT SEATS ONLY
NO REAR SEAT COVERS AVAILABLE



SEAT CONFIGURATION



WORK BEACON LED LIGHT

- 50 ft. of illumination 360° around your vehicle
- Ideal for plowing, hunting and nighttime utility work
- Break-away construction protects the light in areas with tight clearance
- Mounted to the vehicle on the rear of the ROPS
- Easily hinge the light up during use and hinge it down when in transit
- Add LED Headlights for more light

» 2883265 • \$309⁹⁹

XP 1000 '18-21, CREW XP 1000 '19-21, CREW 1000 '20-21, 1000 '20-21

LED HEADLIGHTS

- LED Headlights offer improved brightness and illumination vs stock halogen lights
- Designed with styling specific to Ranger

» 2889072 • \$649⁹⁹

XP 1000 '18-21, XP 1000 CREW '19-21



REVERSE WARNING ALERT

» 2883246 • \$74⁹⁹

XP 1000 '18-21, CREW XP 1000 '19-21, CREW 1000 '20-21, 1000 '20-21
AUTOMATICALLY ACTIVATED WHENEVER THE VEHICLE IS PUT IN REVERSE

HORN

» 2882764 • \$89⁹⁹

XP 1000 '18-21, CREW XP 1000 '19-21, CREW 1000 '20-21, 1000 '20-21

LARGE REAR VIEW MIRROR

» 2879969 • \$89⁹⁹

XP1000 '17-21, CREW XP 1000 '17-21, CREW 1000 '20-21, 1000 '20-21



WIDE ANGLE REAR VIEW MIRROR

- Large 2.5" x 14" adjustable convex mirrored surface gives you a full-spectrum view

» 2881439 • \$179⁹⁹

XP1000 '17-21, CREW XP 1000 '17-21, CREW 1000 '20-21, 1000 '20-21



With Polaris PULSE it's easy to add all your electrical accessories. See P. 28 to learn more.



ELECTRICAL ACCESSORIES

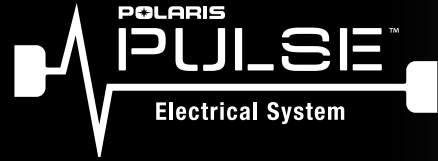

Polaris PULSE is a revolutionary way to provide additional power locations on your vehicle, and makes adding electrical accessories a snap. Electrical accessories are easier to install on the roof, with designated routing areas and plug and play connections. Look for

to identify Polaris PULSE ready accessories.



POLARIS PULSE
Electrical System

XP 1000
CREW XP 1000
1000
CREW 1000

ADD ELECTRICAL SYSTEM ACCESSORIES IN 4 EASY STEPS

STEP 1

CHOOSE A POLARIS PULSE READY ROOF	3-SEAT	CREW
Premium Roof - Poly - Polaris Pursuit Camo	2882913 \$929 ⁹⁹	2883277 \$1,599 ⁹⁹
Premium Roof - Poly - Black	2882912 \$734 ⁹⁹	N/A
Sport Roof - Poly - Black	2882911 \$429 ⁹⁹	2883274 \$709 ⁹⁹

THE FOLLOWING ACCESSORIES EASILY PLUG INTO THE FACTORY INSTALLED POLARIS PULSE UNDER THE HOOD:

- 8-Vent Heater & Defrost System P. 26
- Horn P. 27
- Plow Controller P. 30
- 160 Watt, Waterproof AM/FM Bluetooth® Audio System P. 36
- Light Bars P. 52



POLARIS PULSE UNDERHOOD BUS BAR - 6 POSITION 1000 ONLY

• If upgrading to more than three accessories attaching to the underhood PULSE location, replace 3-position Bus Bar with the Polaris PULSE Underhood Bus Bar - 6 Position

» 2884183 • \$55⁹⁹
1000 '20-21, CREW 1000 '20-21

POLARIS PULSE BATTERY TENDER ADAPTER

• Connects your Battery Minder or trickle charger to your vehicle

» 2884297 • \$29⁹⁹
XP1000 '18-21, CREW XP 1000 '19-21, CREW 1000 '20-21, 1000 '20-21

STEP 2

ADD THE POLARIS PULSE ROOF 6		3-SEAT	CREW
Polaris PULSE Roof 6	2882904 \$124 ⁹⁹	X	X

POLARIS PULSE READY ROOF WIRING EXAMPLE

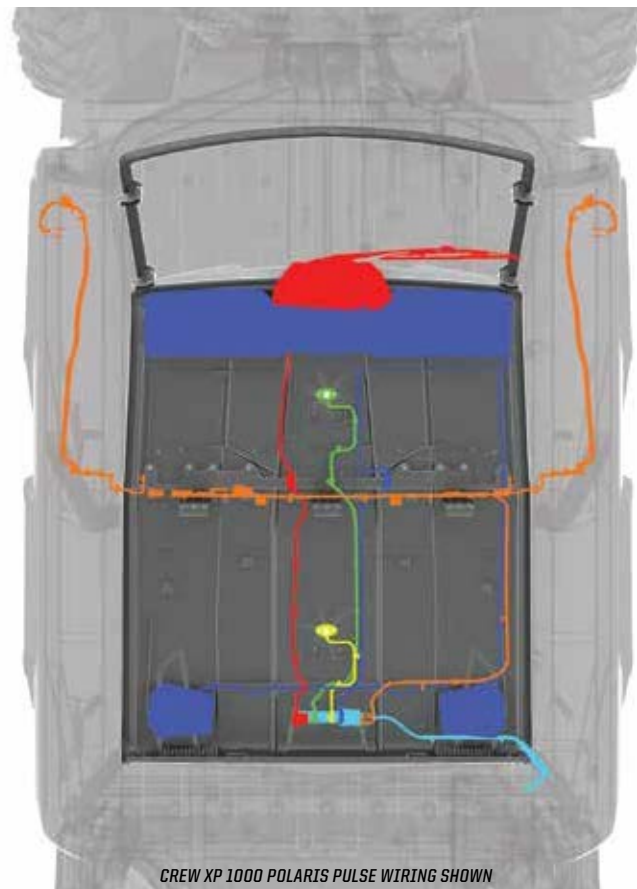

STEP 3 ADD ACCESSORIES*

POWER WINDOW DOORS		3-SEAT	CREW
Power Window Doors - Poly - Black	2884338 \$4,219 ⁹⁹	X	X
Polaris PULSE Wiring Harness - Crew Extension	2883231 \$30 ⁹⁹		X
WINDSHIELD WIPER & WASHER SYSTEM		3-SEAT	CREW
Windshield Wiper & Washer System	2883974 \$634 ⁹⁹	X	X
Polaris PULSE Wiring Harness - Crew Extension	2883231 \$30 ⁹⁹		X
AUDIO: VISOR AUDIO + REAR SPEAKERS		3-SEAT	CREW
300 Watt AM/FM, Bluetooth® Audio Visor with Four 6.5" Waterproof Speakers	2882888 \$1,069 ⁹⁹	X	X
Rear Overhead Speakers	2882876 \$269 ⁹⁹	X	X
Polaris PULSE Wiring Harness - Crew Extension	2883231 \$30 ⁹⁹		X
AUDIO: DASH RADIO & VISOR SPEAKERS		3-SEAT	CREW
160 Watt, Waterproof AM/FM Bluetooth® Audio System	2882750 \$809 ⁹⁹	X	X
300 Watt Overhead Audio Visor Speakers	2882891 \$809 ⁹⁹	X	X
Polaris PULSE Wiring Harness - Crew Extension	2883231 \$30 ⁹⁹		X
MULTI-FUNCTION DOME LIGHT		3-SEAT	CREW
Multi-Function Cab Light (Front) †	2882871 \$134 ⁹⁹	X	X
Polaris PULSE Wiring Harness - Crew Extension	2883231 \$30 ⁹⁹		X

*Add accessories to models without Ride Command
†To add a Multi-Function Dome light for rear passengers, add an additional 2882871

STEP 4 FINISHING TOUCH

CONCEAL WIRING FOR A FINISHED, COMFORTABLE LOOK	3-SEAT	CREW
Premium Roof Liner	2882914 \$269 ⁹⁹	2883457 \$339 ⁹⁹



EASILY ADD LIGHTING

With Polaris PULSE it's easy to add RIGID® and Pro Armor lighting to your RANGER, all LED Light bars listed on P. 52-53 are Polaris PULSE ready, making installation that much easier.

POLARIS PULSE LIGHT BAR WIRING LOCATIONS

FRONT BUMPER // ROOF - FRONT MOUNTED ROOF - REAR MOUNTED // *CREW ROOF - REAR MOUNTED (*REQUIRES EXTENSION)

1 LIGHT WITH 1 SWITCH

• Polaris PULSE Wiring Harness - 1 LED Light Bar • 2883230 • \$114⁹⁹

2 LIGHTS WITH 1 SWITCH

• Polaris PULSE Wiring Harness - 1 LED Light Bar • 2883230 • \$114⁹⁹
• Y-Harness • 2879860 • \$23⁹⁹

2 LIGHTS WITH 2 SWITCHES

• Polaris PULSE Wiring Harness - 1 LED Light Bar • 2883230 • \$114⁹⁹
• Polaris PULSE Wiring Harness - 1 LED Light Bar • 2883230 • \$114⁹⁹

EXTENSIONS FOR CREW

• Polaris PULSE Wiring Harness - 1 LED Light Bar - Crew Extension • 2883231 • \$30⁹⁹

WINCHES



ADD A PLOW
P. 48

WHETHER HARD AT WORK OR ON THE TRAILS, ADD A WINCH TO...

- GET THE JOB DONE RIGHT
- GET YOU ON YOUR WAY FASTER
- BE PREPARED FOR UNEXPECTED SITUATIONS

WHY POLARIS?



TESTED **1,200+**
PULLS AT MAX LOAD



BUILT TO WITHSTAND
-20° F TEMPERATURES



OPERATES **FULLY**
SUBMERGED



MILITARY
TESTED & APPROVED

UPGRADE YOUR CONTROLS HD OR PRO HD WINCHES

POWER CONTROLLER

- Control winch/plow hydraulics from shift knob

» 2883247 • \$269⁹⁹

XP 1000 '18-21, CREW XP 1000 '19-21,
CREW 1000 '20-21, 1000 '20-21

CONTROLS HYDRAULICS

REQUIRES WINCH ADAPTER
2884159 WHEN USING A WINCH
FOR LIFTING DEVICE



WIRED REMOTE CONTROL

- Must order remote handle and socket together

» REMOTE HANDLE

4013466 • \$79⁹⁹

WORKS WITH ALL MODELS

» SOCKET

4017102 • \$69⁹⁹

DASH REMOTE CONTROL

- Must order remote switch and harness together

» REMOTE SWITCH

4017200 • \$101⁹⁹

XP 1000 '18-21, CREW XP 1000 '19-21,
CREW 1000 '20-21, 1000 '20-21

» HARNESS

2415055 • \$42⁹⁹

REPLACEMENT PARTS

SYNTHETIC ROPE

6,000 LB.

» 2879188 • \$229⁹⁹

4,500 LB.

» 2879187 • \$179⁹⁹

STEEL CABLE

3,500 LB.

» 2878890 • \$59⁹⁹



FEATURES

ALL POLARIS ENGINEERED WINCHES COME WITH:



1. Set Dial to FREE SPOOL (N) to attach Winch Hook
2. Set Dial to PULL (L) for Winch Mode
3. Set Dial to ROPE RECOVERY (H) for 5x Faster Rope Recovery

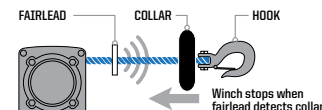

Stops winch at end of pull to prevent driveline stress and plow overlifting



- Lightweight & Easy to Handle
- Superior Flexibility & Strength
- 50 ft. long



50 ft. range wireless remote control with unique code for interference-free operation

PRO PRO HEAVY DUTY SERIES

TOP-OF-THE-LINE FEATURES



HD HEAVY DUTY SERIES

BUILT FOR THE OFF-ROAD



PRO PRO HEAVY DUTY SERIES



WARRANTY



INTEGRATED WIRING, MOUNT, PREASSEMBLED

HOOK WITH STRAP

CUT STEEL GEARS & SEALED DRIVETRAIN

SEALED PERMANENT MAGNET MOTOR

HD HEAVY DUTY SERIES

NOT AVAILABLE

ADD AUTO STOP UPGRADE

» 2883454 • \$129⁹⁹

WORKS WITH 2882714

SYNTHETIC ROPE REQUIRED



WITH STEEL ROLLER FAIRLEAD

ADD SYNTHETIC ROPE

» 2879187 • \$179⁹⁹



ADD WIRELESS REMOTE

» 2883455 • \$179⁹⁹

WORKS WITH 2882714



MODEL

XP 1000 '18-21
CREW XP 1000 '19-21
1000 '20-21
CREW 1000 '20-21

NON EPS RANGER 1000 REQUIRES FRONT BUMPER

6,000 LB.

TOP SELLER

2882710

\$1,229⁹⁹

4,500 LB.

TOP SELLER

2882711

\$1,099⁹⁹

4,500 LB.

TOP SELLER

2882714

\$809⁹⁹

3-SEAT & CREW

1000 / XP 1000

ROOFS

WINDSHIELDS

REAR PANELS

DOORS

CAB COMFORT

ELECTRICAL

WINCHES

PROTECTION

TECHNOLOGY

STORAGE

PROTECTION

HD FRONT BRUSHGUARD with integrated plow mount and mounting locations for seamless installation of lighting accessories. Additional 36" of storage area is included for the Off-Road Jack Kit or other recovery equipment.



STANDARD BRUSHGUARDS

HD BRUSHGUARDS

PERFECT FOR: **INCREASED PROTECTION AROUND LIGHTING AND FENDERS**

FRONT



INSTALLS DIRECTLY TO STOCK BUMPER

REAR



1 1/2" DIAMETER STEEL TUBE CONSTRUCTION

CAN BE USED IN CONJUNCTION WITH A TOW HITCH

- Requires 2207941 with Ride Command
- » FRONT • 2882531 • **\$339⁹⁹** TOP SELLER » REAR • 2882529 • **\$269⁹⁹** TOP SELLER
- XP 1000 '18-21, CREW XP 1000 '19-21, CREW 1000 '20-21, 1000 '20-21 FRONT BRUSHGUARD DOES NOT FIT HIGH LIFTER MODELS
- 1000 NON-EPS VEHICLES REQUIRE FRONT BUMPER: 2884123
- For use with vehicles with Ride Command with Front Camera
- » RIDE COMMAND BUMPER ADAPTER • 2207941 • **\$48⁷⁹**



- Increased protection over stock bumper with integrated mounting locations for accessories and lights (sold separately) with a durable matte black finish
- Easy installation with included mounting hardware
- Additional 36" storage area for recovery equipment
- » FRONT • 2885105 • **\$933⁹⁹** » REAR • 2884217 • **\$544⁹⁹**
- XP 1000 '18-21, CREW XP 1000 '19-21, CREW 1000 '20-21, 1000 '20-21 FRONT BRUSHGUARD DOES NOT FIT HIGH LIFTER MODELS
- REAR: RECOMMENDED WITH ANY OF OUR RIGID OR PRO ARMOR POD LIGHTS FOR UPGRADED LIGHTING
- » OFF-ROAD JACK KIT 2881201 • **\$269⁹⁹**

ROCK GUARDS



3-SEAT



CREW

ROCK GUARD WITH STEP

- Reliable, hard-working protection for edges of vehicle
- Integrated step with boot scraper helps keep interior clean
- Mounts directly to the frame, instead of underneath, for maximum ground clearance
- Steel construction with black e-coat and durable black powdercoated finish

» 3-SEAT • 2882530 • **\$269⁹⁹**
XP 1000 '18-21, 1000 '20-21

» CREW • 2883398 • **\$469⁹⁹**
CREW XP 1000 '19-21, CREW 1000 '20-21

FRONT BRUSHGUARD 1000 ONLY

- Increased protection over stock bumper
- Sturdy stamped steel and tube construction
- Integrated mounting positions for plow and winch accessories

» 2884123 • **\$454⁹⁹**
1000 '20 CAMO OR IN-MOLD, CREW 1000 '20 CAMO OR IN-MOLD, 1000 '21 NON EPS, CREW 1000 '21 NON EPS
REQUIRED TO INSTALL WINCH/PLOW ON NON EPS RANGER 1000

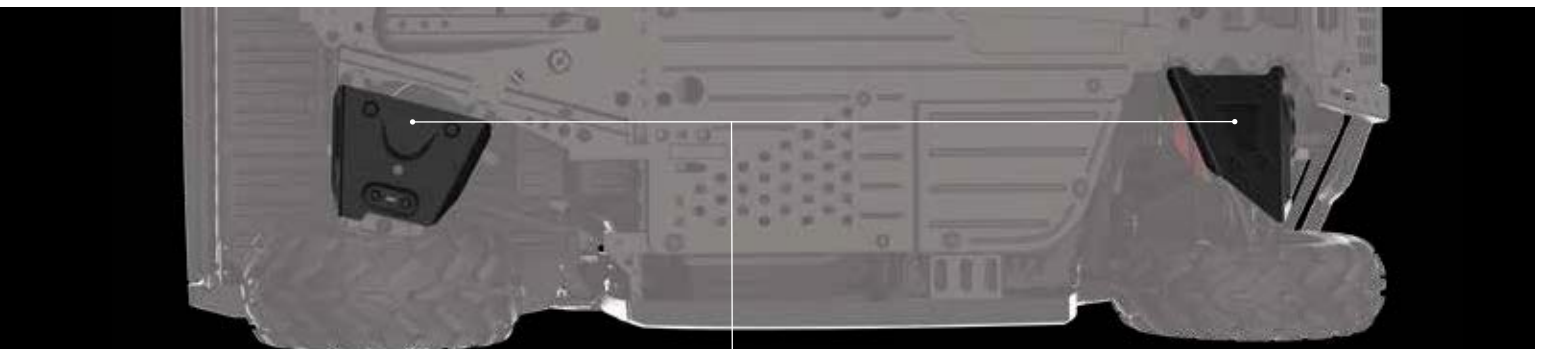

HMW A-ARM GUARDS

- Strong, 3/4" thick, durable, lightweight HMW (high molecular weight) polyethylene construction helps protect against off-road impacts
- Molded specifically for the RANGER XP 1000 & 1000 front suspension for a sure fit and low-profile presence
- Easy bolt-on design with mounting hardware included

» FRONT • 2882784 • **\$269⁹⁹**
XP 1000 '18-20, CREW XP 1000 '19-21, CREW 1000 '20-21, 1000 '20-20
WILL NOT FIT ARCHED A-ARM MODELS

» REAR • 2882787 • **\$269⁹⁹**
XP 1000 '18-21, CREW XP 1000 '19-21, CREW 1000 '20-21, 1000 '20-21
WILL NOT FIT ARCHED A-ARM MODELS

REVOLUTIONIZING THE OFF-ROAD EXPERIENCE



- BUILT IN GPS WITH TOPOGRAPHY MAPS TO SEE YOUR LOCATION AND PLAN YOUR RIDE
- MEDIA PLAYER WITH BUILT IN AM/FM TUNER FOR ALL YOUR FAVORITE MUSIC
- GROUP RIDE FOR BUDDY TRACKING, TO SEE YOUR FRIENDS ON THE MAP, TRACK AND SHARE RIDE STATS ON THE DISPLAY OR RIDE COMMAND MOBILE APP

RIDECOMMAND

RIDE COMMAND 7" DISPLAY

- 7" High Bright Touchscreen visible in all conditions
- Displays critical vehicle information for fuel level, coolant temp and battery voltage
- Media player with built in AM/FM tuner
- Enhanced Group Ride capability to track and share your ride
- Dedicated shortcut buttons for quick access to features
- Bluetooth® and USB smart phone connectivity
- Front camera support for better visibility on and off trail
- Includes Plow Mode on XP 1000 '18-20 and CREW XP 1000 '19-20 models (see P. 46 for details)

» 2884072 • \$1,999⁹⁹
 XP 1000 '18-21, CREW XP 1000 '19-21, CREW 1000 '20-21, 1000 '20-21
 SPEAKERS NOT INCLUDED. MUST CHOOSE AUDIO PACKAGE FOR AUDIO OUTPUT.

RIDE COMMAND MOUNT KIT

- Mount Ride Command seamlessly into the dash for perfect fit and finish
- Comes with wiring harnesses needed
- Includes front camera

» 2882872 • \$399⁹⁹
 XP 1000 '18-21, CREW XP 1000 '19-21, CREW 1000 '20-21, 1000 '20-21, ALL NORTHSTAR EDITIONS '18-20

» 2884564 • \$649⁹⁹
 XP 1000 BACKCOUNTRY '19-21, CREW XP 1000 BACKCOUNTRY '19-21, CREW 1000 WINTER PREP '20-21, CREW 1000 '20-21, NORTHSTAR EDITION '21, XP 1000 TRAIL BOSS '21, CREW XP 1000 TRAIL BOSS '21
 FOR ALL MODELS WITH 900 WATT STATOR UPGRADE

ADD RIDE COMMAND PLOW MODE HARNESS P. 46

MBQUART®

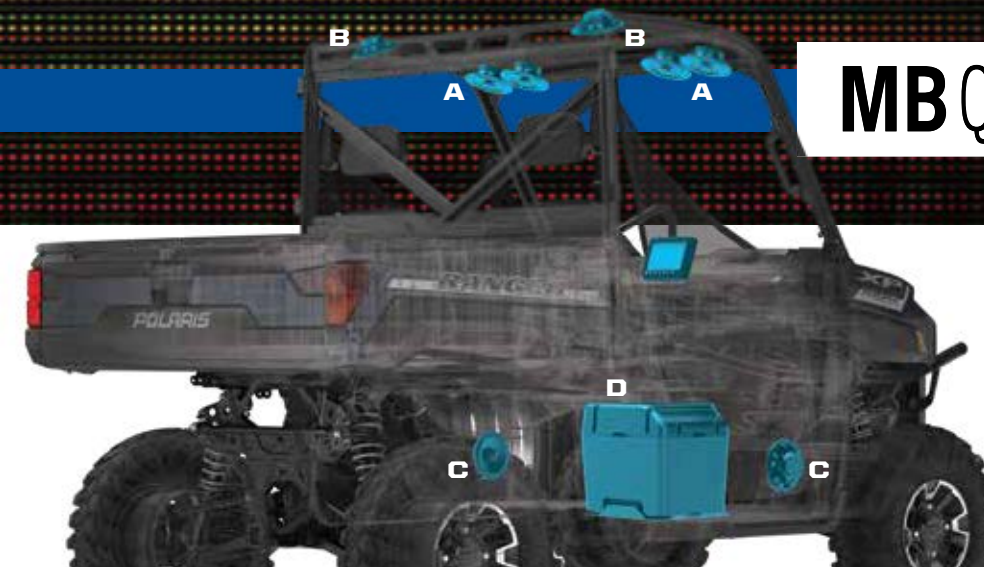

BUILD YOUR SOUND WITH RIDE COMMAND

STEP 1 ADD HEAD UNIT

RIDE COMMAND
 2884072 • \$1,999⁹⁹

STEP 2 ADD MOUNT

2882872 • \$399⁹⁹
 XP 1000 '18-21, CREW XP 1000 '19-21, CREW 1000 '20-21, 1000 '20-21
 FOR NORTHSTAR AND ALL OTHER MODELS WITHOUT 900 WATT STATOR

OR

2884564 • \$649⁹⁹
 XP 1000 '18-20, CREW XP 1000 '19-20, CREW 1000 '20, 1000 '20
 FOR 900 WATT STATOR

STEP 3

UPGRADE AUDIO BY ADDING VISOR OR DASH AUDIO

OPTION 1 VISOR AUDIO

OPTION 1 VISOR AUDIO	A. OVERHEAD VISOR SPEAKERS 2882891 • \$809 ⁹⁹ HARNESS REQUIRED 2882904 • \$124 ⁹⁹ CREW MODELS REQUIRE ADDITIONAL 2883231 AUDIO ANTENNA KIT 2889044 • \$63 ⁹⁹ REQUIRED FOR AM/FM	+	B. REAR OVERHEAD SPEAKERS 2882876 • \$269 ⁹⁹	+	C. DOOR SPEAKERS 2882889 • \$276 ⁹⁹	+	D. 10" MAXBOOST SUBWOOFER 2884233 • \$809 ⁹⁹ XP 1000 '18-21, CREW XP 1000 '19-21 WITH 900 WATT STATOR
		OR		OR			

OPTION 2 DASH AUDIO

OPTION 2 DASH AUDIO	AUDIO DASH SPEAKERS 2883956 • \$589 ⁹⁹	+	B. REAR OVERHEAD SPEAKERS 2882876 • \$269 ⁹⁹	OR	C. DOOR SPEAKERS 2882889 • \$276 ⁹⁹	+	D. 10" MAXBOOST SUBWOOFER 2884233 • \$809 ⁹⁹ RANGER MODELS WITH RIDE COMMAND PACKAGE REQUIRE 2883232 ADAPTER HARNESS

AUDIO DASH SPEAKERS INCLUDE BUILT-IN FOUR CHANNEL AMPLIFIER (40-WATTS) AND TWO OFF-ROAD GRADE 5.25" SPEAKERS

VISIT POLARIS.COM/SHOPRANGER FOR FITMENT FOR YOUR SPECIFIC MODEL & YEAR

DOWNLOAD THE RIDE COMMAND MOBILE APP



CHECK FOR FEATURE ENHANCEMENTS & UPDATES AT POLARIS.COM/RIDECOMMAND

3-SEAT & CREW

1000 / XP 1000

ROOFS

WINDSHIELDS

REAR PANELS

DOORS

CAB COMFORT

ELECTRICAL

WINCHES

PROTECTION

TECHNOLOGY

STORAGE

OFF-ROAD GRADE AUDIO

When you research audio solutions, you'll see manufacturers bragging about how their audio equipment is "Marine Grade". Or worse yet, you'll discover they are repackaged components built for automotive applications. MB Quart®, combined with Polaris, engineers Off-Road Grade Audio equipment that's proven to deliver the loudest, crispest sound in the harshest conditions. Rain, snow, mud, heat, cold, dust—**ANY PLACE YOUR RANGER EXCELS, SO WILL YOUR AUDIO.**

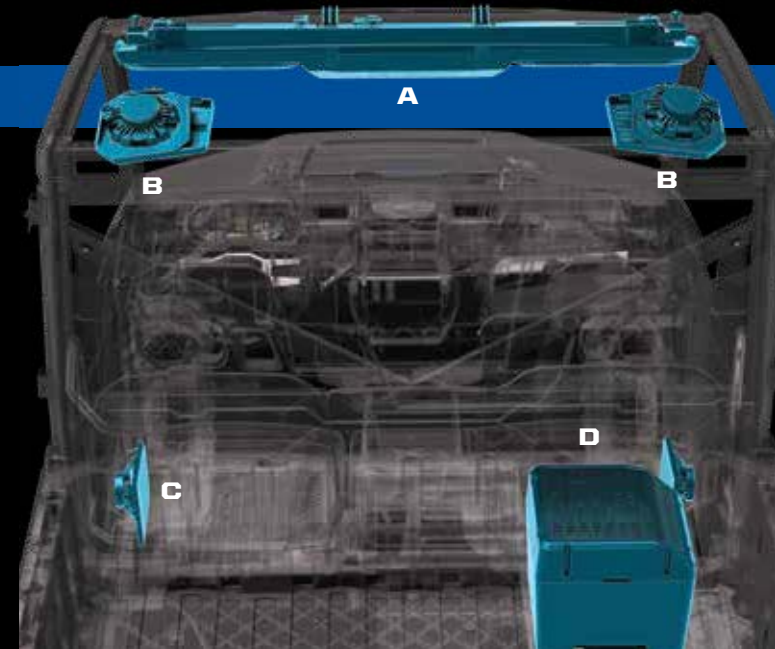

1 CHOOSE A HEAD UNIT Control all aspects of your sound system. Choose what to listen to and how loud.



160 WATT, WATERPROOF AM/FM BLUETOOTH® AUDIO SYSTEM



- All-in-one solution for giving your vehicle a performance-ready sound system
- USB input, Bluetooth® 4.0 compatible, Apple® Control, AM/FM tuner
- Built-in four channel amplifier (40-watts x 4)
- Two off-road grade 5.25" speakers with Titanium Dome Tweeters and Polypropylene Cones

» 2882750 • \$809⁹⁹
 XP 1000 '18-21, CREW XP 1000 '19-21, CREW 1000 '20-21, 1000 '20-21

USE AS IS OR ADD ADDITIONAL SPEAKERS



300 WATT AM/FM, BLUETOOTH® AUDIO VISOR WITH FOUR 6.5" WATERPROOF SPEAKERS TOP SELLER



- One-step solution for off-road audio
- USB input, Bluetooth® 4.0 compatible, Apple® Control, AM/FM tuner
- 300-Watt four channel amplifier (75 watts x 4)
- 4 6.5" coaxial speakers with Titanium Dome Tweeters and Polypropylene Cones
- Audio outputs to drive additional speakers
- 4 Accessory knocks outs
- Polaris PULSE Electrical System

» 2882888 • \$1,069⁹⁹
 XP 1000 '18-21, CREW XP 1000 '19-21, CREW 1000 '20-21, 1000 '20-21
 NOT COMPATIBLE WITH RIDE COMMAND

COMES WITH OVERHEAD VISOR SPEAKERS (AT RIGHT) USE AS IS OR ADD ADDITIONAL SPEAKERS

2 ADD SPEAKERS - MIX AND MATCH

Your RANGER is ready for work, but is it ready to entertain? From a simple two-speaker setup to a complete system - add speakers to BUILD IT YOUR WAY.



A VISOR SPEAKERS

STANDARD WITH VISOR STEREO 300 WATT OVERHEAD AUDIO VISOR SPEAKERS

- Built-in 300-Watt amplifier (75-watt x 4 channels)
- Four 6.5" speakers located in the overhead
- Waterproof system for reliable power and sound quality

» 2882891 • \$809⁹⁹
 XP 1000 '18-21, CREW XP 1000 '19-21, CREW 1000 '20-21, 1000 '20-21



B OVERHEAD SPEAKERS

REAR OVERHEAD SPEAKERS

- Two 6.5" rear roof mounted speakers with Titanium Dome Tweeters and Polypropylene Cones
- Easy install
- Waterproof system for reliable power and sound quality

» 2882876 • \$269⁹⁹
 XP 1000 '18-21, CREW XP 1000 '19-21, CREW 1000 '20-21, 1000 '20-21



C DOOR SPEAKERS

6.5" WATERPROOF DOOR SPEAKERS

- Two 6.5" waterproof speakers with Titanium Dome Tweeters and Polypropylene Cones
- Easy install on manual or power window doors

» 2882889 • \$276⁹⁹
 XP 1000 '18-21, CREW XP 1000 '19-21, CREW 1000 '20-21, 1000 '20-21



D SUBWOOFER

MAX BOOST 10" 250 WATT SUBWOOFER XP 1000 ONLY

- Built-in 250-watt amplifier powering 10" waterproof subwoofer
- Fits RANGER XP 1000 with flip-up passenger seat

» 2882890 • \$809⁹⁹
 XP 1000 '18-21, CREW XP 1000 '19-21
 NOT COMPATIBLE WITH RIDE COMMAND
 WILL NOT FIT WITH 2882910 STORAGE INSTALLED

3 MAKE IT WORK

VISOR STEREO HEAD UNIT

VISOR SPEAKERS

POLARIS PULSE ROOF 6

- Required with Visor Stereo (2882888)
- Required to add Visor Speakers (2882891)

» TOP SELLER 2882904 • \$124⁹⁹
 XP 1000 '18-21, CREW XP 1000 '19-21, CREW 1000 '20-21, 1000 '20-21

CREW MODELS

CREW EXTENSION

- Required for all Crew models where Polaris PULSE Roof 6 Harness (2882904) is required

» 2883231 • \$30⁹⁹
 XP 1000 '20-21, CREW XP 1000 '19-21, CREW 1000 '20-21

WANT EPIC SOUND STRAIGHT FROM THE FACTORY?

CHECK OUT THE MB QUART® AUDIO PACKAGE
POLARIS.COM/RANGERPACKAGES

NEW! FALL AVAILABILITY GEOFENCING KIT

- Keep vehicle operators safe by quickly setting and controlling ride boundaries such as speed limits within and outside the geofenced area
- Ensure operators are riding at the appropriate speed for their experience and terrain by setting a max speed from your Ride Command app
- Activate passcode protection and to have full control of who and when the vehicle is being operated

» 2884779 • \$259⁹⁹
 1000 '20-21, CREW 1000 '20-21

STORAGE

LOCK & RIDE

EXCLUSIVE TO POLARIS, LOCK & RIDE ACCESSORIES LET YOU QUICKLY CHANGE FROM ONE TASK TO ANOTHER WITH HUNDREDS OF OPTIONS.

WITH THE FLIP OF A LEVER, LOCK & RIDE PLUNGERS USE OUTWARD PRESSURE TO EXPAND FOR A SECURE FIT.

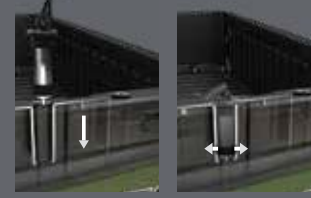
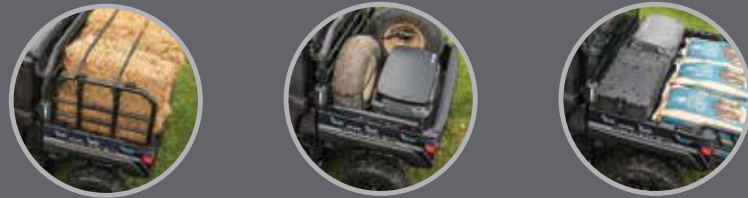

CARGO BED REAR WINCH



- Assists lifting heavy objects like hay bales or big game up into rear cargo bed
- 300 lb. winch mounts high on rear cab frame
- Equipped with 15 ft. of premium synthetic rope

» 2884215 • \$707 ⁷⁸

XP 1000 '18-21, CREW XP 1000 '19-21, CREW 1000 '20-21, 1000 '20-21
REQUIRES ROOF PULSE: 2882904



LOCK & RIDE FRONT BRUSHGUARD STORAGE RACK

- Allows extra storage space in front of your vehicle
- Accommodates a Polaris Northstar 30 Quart Cooler or similar sized items
- Attaches and removes easily
- Mounts to existing plow mounting points

» 2883971 • \$389 ⁹⁹

XP 1000 '18-21, CREW XP 1000 '19-21, CREW 1000 '20-21, 1000 '20-21



LOCK & RIDE TONNEAU COVER

- Protects items stored in cargo bed from the elements
- HDPE construction on steel sub-frame can support up to 100 lb. on top of cover
- Molded storage area for Polaris Northstar 30 Quart Cooler
- Convenient hinged middle panel for easy access
- Easy installation with Lock & Ride

» 2884218 • \$709 ⁹⁹

XP 1000 '18-21, CREW XP 1000 '19-21, CREW 1000 '20-21, 1000 '20-21



LOCK & RIDE

TIP-DOWN HEADACHE RACK

- Rack tips down for additional storage solutions with space below and multiple tie-down points
- Lightweight and heavy-duty rack protects the cab of your RANGER and lets you haul even more

» 2881531 • \$469 ⁹⁹

XP 1000 '17-21, CREW XP 1000 '17-21, CREW 1000 '20-21, 1000 '20-21
DOES NOT FIT HIGH LIFTER MODELS



LOCK & RIDE

CARGOMAX SYSTEM

- Comes standard with a support bar that ties the two sides together for a sturdy cargo hold
- Designed to attach to the Lock & Ride Tip-Down Headache Rack for additional support and three-sided containment
- Adjustable utility hooks provide more options for hanging tools, cords or gear

» 2882177 • \$669 ⁹⁹

XP 1000 '17-21, CREW XP 1000 '17-21, CREW 1000 '20-21, 1000 '20-21



LOCK & RIDE

BED EXTENDER/DIVIDER

- Extend or divide the cargo box
- Installs in any location in the box
- Multiple tie-down points available to secure cargo

» 2882752 • \$269 ⁹⁹

XP 1000 '18-21, CREW XP 1000 '19-21, CREW 1000 '20-21, 1000 '20-21



FRONT HOOD STORAGE RACK

- Front curve helps keep cargo in place when traveling
- Provides additional protection
- Fully integrated pivots to gain under-hood access
- Requires Bumper Adapter 2207941 with Ride Command

» 2882690 • \$469 ⁹⁹

XP 1000 '18-21, CREW XP 1000 '19-21, CREW 1000 '20-21, 1000 '20-21
DOES NOT FIT WITH BUMPER 2882531
REQUIRES 2207941 TO WORK WITH RIDE COMMAND CAMERA

75+ COMBINATIONS TO MAKE IT YOUR OWN

With a full line of Lock & Ride accessories, you can haul more and do more. Use the chart below to see what combinations work together.

POLARIS RANGER STORAGE MATRIX XP 1000 / 1000 570 FULL-SIZE	LOCK & RIDE Tip-Down Headache Rack	LOCK & RIDE CargoMax System	LOCK & RIDE Bed Extender/Divider	LOCK & RIDE Storage Box	LOCK & RIDE Tool Rack	LOCK & RIDE Chainsaw Mount	LOCK & RIDE 60 Gallon Boomless Utility Sprayer	Cargo Bed Rear Winch	LOCK & RIDE Front Brushguard Storage Rack	LOCK & RIDE Tonneau Cover	Cargo Bed Mat
LOCK & RIDE Tip-Down Headache Rack 2881531	2881531	2882177	2882752	2883279	2881533	2879354	2879799	2884215	2883971	2884218	2882751
LOCK & RIDE Tip-Down Headache Rack 2881531		✓	✓	✓		✓	✓		✓		✓
LOCK & RIDE CargoMax System 2882177	✓			✓ ²					✓		✓
LOCK & RIDE Bed Extender/Divider 2882752	✓			✓				✓	✓		✓
LOCK & RIDE Storage Box 2883279	✓	✓ ¹	✓		✓	✓		✓	✓		✓
LOCK & RIDE Tool Rack 2881533			✓	✓		✓		✓	✓		✓
LOCK & RIDE Chainsaw Mount 2879354	✓		✓	✓	✓		✓	✓	✓		✓
LOCK & RIDE 60 Gallon Boomless Utility Sprayer 2879799	✓						✓	✓	✓		✓
Cargo Bed Rear Winch 2884215			✓	✓	✓	✓	✓		✓		
LOCK & RIDE Front Brushguard Storage Rack 2883971	✓	✓	✓	✓	✓	✓	✓	✓		✓	✓
LOCK & RIDE Tonneau Cover 2884218									✓		✓
Cargo Bed Mat 2882751	✓	✓	✓	✓	✓	✓	✓	✓	✓	✓	

¹ Storage box at front of cargo box if not used with Tip-down Headache Rack

² Storage box at front of cargo box

LOCK & RIDE QUICKSTRAP

- The quickest and most secure way to mount Polaris accessories
 - Sold as a pair
- » 2882187 • \$59 ⁹⁹
ALL COOLERS, RANGER CARGO BOXES



LOCK & RIDE D-RINGS

- The most versatile Lock & Ride accessory - add as many as you need to secure your cargo with bungee cords or straps
- » 2881545 • \$43 ⁹⁹
ALL RANGER CARGO BOXES



1.5" x 15' 5,500 LB RATCHET STRAP

- Heavy duty webbing
 - 5,500 lb. Maximum Load / 1,833 lb. Working Load
 - 2 Pack
- » 2884031 • \$59 ⁹⁹

2" x 20' 10,000 LB RATCHET STRAP

- Heavy duty webbing
 - 10,000 lb. Maximum Load / 3,300 lb. Working Load
 - Floating D-Rings & Double J-Hooks
- » 2884032 • \$43 ⁹⁹

STORAGE

LOCK & RIDE

CHAINSAW MOUNT

- Can be secured to the outside of the bed wall so your chainsaw is within reach at all times

» 2879354 • \$179⁹⁹

XP 1000 '17-21, CREW XP 1000 '17-21, CREW 1000 '20-21, 1000 '20-21



LOCK & RIDE

60 GALLON BOOMLESS UTILITY SPRAYER

» 2879799 • \$1,209⁹⁹

XP 1000 '17-21, CREW XP 1000 '17-21, CREW 1000 '20-21, 1000 '20-21



BED ESSENTIALS

FIRE EXTINGUISHER HOLDER

- Only holds a 3.25" diameter extinguisher
- Quick release strap allows for easy use

» 2882158 • \$114⁹⁹

XP 1000 '17-21, CREW XP 1000 '17-21, CREW 1000 '20-21, 1000 '20-21



ELECTRONIC CARGO BOX LIFT

» 2884141 • \$799⁹⁹

XP 1000 '18-21, CREW XP 1000 '19-21, CREW 1000 '20-21, 1000 '20-21



RIDE & REPAIR ESSENTIALS KIT

» 2881207 • \$134⁹⁹

ALL RANGER MODELS



CARGO BED MAT

- Non-slip surface to better secure loads and keep cargo bed clean

» 2882751 • \$179⁹⁹

XP 1000 '18-21, CREW XP 1000 '19-21, CREW 1000 '20-21, 1000 '20-21



TOW & HAUL



TRAILER BALLS

» 2" WITH 3/4" SHANK
2877603 • \$18⁹⁹

» 1 7/8" WITH 3/4" SHANK
2877602 • \$18⁹⁹



2" BALL MOUNT

» 2" RECEIVER
2875320 • \$59⁹⁹



3:1 HITCHES

» 2" x 2" RECEIVER
2830522 • \$48⁷⁹

» 1 3/4" x 1 1/4" RECEIVER
2830523 • \$48⁷⁹

» 1 7/8" REPLACEMENT BALL
2830524 • \$12¹⁹

ALL RANGER MODELS



FRONT MOUNT RECEIVER HITCH

- Standard 2" receiver mount bolts directly to the frame
- UTV attachment works with Polaris bumpers
- Rated at 100 lb. tongue weight and 1,000 lb. towing

» 2882782 • \$169⁹⁹

XP 1000 '18-20, CREW XP 1000 '19-20, CREW 1000 '20, 1000 '20



TASK-SPECIFIC TOOLS

LOCK & RIDE

TOOL RACK

- Attach on the inside or outside of the cargo bed

» 2881533 • \$269⁹⁹

XP 1000 '17-21, CREW XP 1000 '17-21, CREW 1000 '20-21, 1000 '20-21



ORGANIZE & PROTECT

LOCK & RIDE

STORAGE BOX

- Enough room to store all the tools you need to get the job done
- Internal organizational dividers keep gear from rolling around
- Easily detaches from vehicle

» 2883279 • \$439⁹⁹

XP 1000 '17-21, CREW XP 1000 '17-21, CREW 1000 '20-21, 1000 '20-21



DO MORE

COOLERS

SEE P. 42



HUNT

SEE P. 44



COLD WEATHER

SEE P. 46

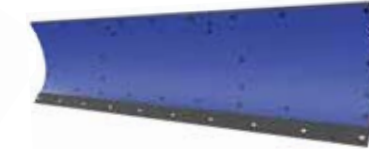

LIGHTING

SEE P. 52



3-SEAT & CREW

1000 / XP 1000

ROOFS

WINDSHIELDS

REAR PANELS

DOORS

CAB COMFORT

ELECTRICAL

WINCHES

PROTECTION

TECHNOLOGY

STORAGE

**KEEP IT
ICE COLD**



**GRIZZLY TESTED.
POLARIS APPROVED.**



This cooler is IGBC-approved, meaning it withstands the power expended by a typical grizzly bear if it was trying to get inside.

Seriously, there are experts who know what a grizzly is capable of doing, and they certify our coolers can take it.



**30, 60 & 105
QUART FEATURES**



ComfortCarry Handles



TravelLock System



EasyOut Drain System



NoSlip Rubber Feet



PolarWall Insulation



IceLock Seal

POLARIS NORTHSTAR COOLERS CAN SURVIVE JUST ABOUT ANYTHING - FROM EXTREME HEAT TO A NASTY TUMBLE OFF A VEHICLE.



105 QUART

- » GRAPHITE • 2883426 • **\$509⁹⁹**
- » DESERT • 2883392 • **\$509⁹⁹**



60 QUART

- » GRAPHITE • 2883425 • **\$409⁹⁹**
- » DESERT • 2881259 • **\$409⁹⁹**



30 QUART

- » GRAPHITE • 2883424 • **\$309⁹⁹**
- » DESERT • 2881315 • **\$309⁹⁹**



15 QUART

- » GRAPHITE • 2883968 • **\$249⁹⁹**













20 QUART SOFTSIDE

- » GRAPHITE • 2883390 • **\$209⁹⁹**

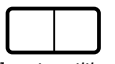
**HOLDS ICE
30+
HOURS
LONGER
THAN YETI^{®*}**

*YETI is a registered trademark of YETI COOLERS, LLC

ESSENTIAL ACCESSORIES SO YOUR COOLER WORKS AS HARD AS YOU DO

COOLER ACCESSORIES	105 QUART	60 QUART	30 QUART	DON'T FORGET THESE ACCESSORIES		
 <p>WIRE BASKET</p>	2883648 • \$59⁹⁹	2882185 • \$43⁹⁹	2882438 • \$36⁹⁹	 <p>TUMBLERS</p> <ul style="list-style-type: none"> » 30 OZ • 2883394 • \$36⁹⁹ » 20 OZ • 2883393 • \$30⁹⁹ 	 <p>QUICKSTRAP</p> <ul style="list-style-type: none"> » 2882187 • \$59⁹⁹ ALL COOLERS AND POLARIS RANGER CARGO BOXES 	
 <p>DIVIDERS Doubles as cutting board</p>	2883468 • \$43⁹⁹ COMES WITH ONE DIVIDER  1 way to partition	2882184 • \$59⁹⁹ COMES WITH TWO DIVIDERS  2 ways to partition	2882186 • \$30⁹⁹ COMES WITH ONE DIVIDER  1 way to partition			 <p>BOTTLE OPENER</p> <ul style="list-style-type: none"> » 2882183 • \$15⁹⁹ ALL COOLERS
 <p>SEAT CUSHION</p>	NOT AVAILABLE	2882179 • \$114⁹⁹	2882507 • \$89⁹⁹			
 <p>WHEELS</p>	2883967 • \$119⁹⁹	2882180 • \$124⁹⁹	NOT AVAILABLE			

PROTECTING YOUR ESSENTIAL GEAR SINCE 1943



KOLPIN STRONGHOLD SYSTEM

Polaris is proud to partner with Kolpin Outdoors, an industry leader in off-road accessories and the premier name in gun boots and mounts. If you need to secure a firearm while riding, simply attach the auto-latch mount and choose your Gun Boot.

IDEAL FOR SECURE TRANSPORT OF SCOPED RIFLES AND SHOTGUNS

STEP 1 CHOOSE YOUR MOUNT

STEP 2 CHOOSE YOUR BOOTS



LOCK & RIDE KOLPIN STRONGHOLD AUTO-LATCH DOUBLE BOOT MOUNT

- Precision angle adjustable for a custom fit
 - Provides a quick and secure attachment point
- » DOUBLE BOOT MOUNT • 2883970 • **\$284⁹⁹**
» SINGLE BOOT MOUNT • 2884106 • **\$83⁹⁹**

KOLPIN STRONGHOLD GUN BOOT XL

- Includes Zippered internal Liner
 - Lockable
- 52" L x 3 3/4" W x 10 1/2" H
- » 2882430 • **\$109⁹⁹**
Requires Auto-Latch mount 2883970 or 2884106 to mount to vehicle

KOLPIN STRONGHOLD GUN BOOT L

- 52" L x 4 3/4" W x 9 3/4" H
- » 2882426 • **\$83⁹⁹**
Requires Auto-Latch mount 2883970 or 2884106 to mount to vehicle

CARGO BED REAR WINCH

- Assists lifting heavy objects like hay bales or big game up into rear cargo bed
 - 300 lb. winch mounts high on rear cab frame
 - Equipped with 15 ft. of premium synthetic rope
- » 2884215 • **\$707⁹⁹**
XP 1000 '18-21, CREW XP 1000 '19-21, CREW 1000 '20-21, 1000 '20-21



LOCK & RIDE GUN RACK 6

- Adjustable to store guns at an angle or vertical (shown at angle)
 - Holds 6 rifles or shotguns securely with soft rubber v-grips
 - Stock is secured in place with a soft molded rubber inlay along the bottom of the rack
 - Rack can be adjusted into 3 positions based on firearm height
- » 2882159 • **\$509⁹⁹**
XP 1000 '17-21, CREW XP 1000 '17-21, CREW 570 FULL-SIZE '18-21, CREW 1000 '21, 570 FULL-SIZE '17-21, 1000 '20-21



IN-CAB GUN MOUNT

- Gives you instant gun access in the field
 - Mounts securely to the floor and adjusts up to 45° forward
 - Robust, molded gun butt holder at base
 - Quick-release barrel straps
 - Easily removable
 - Accommodates scope-equipped rifles
- » 2883263 • **\$209⁹⁹**
XP 1000 '18-21, CREW XP 1000 '19-21, CREW 1000 '20-21, 1000 '20-21
NORTHSTAR EDITION REQUIRES 2208023 HWD KIT TO INSTALL ON THE 2019 AND NEWER MODELS

POLARIS PURSUIT CAMO SxS FIELD COVER

- Full-coverage camo print cover hides your side-by-side while in the field
 - Lightweight material protects your RANGER from inclement weather
- » 2882160 • **\$169⁹⁹**
XP 1000 '17-21, EV '11-21, 570 FULL-SIZE '17-21, 570 '14-21, 500 '11-21, 1000 '20-21



KOLPIN RHINO GRIPS IDEAL FOR CARRYING RIFLES, SHOTGUNS, BOWS AND CROSSBOWS



LOCK & RIDE RHINO GRIP PRO

- » 2884107 • **\$109⁹⁹**
ALL RANGER MODELS (EXCEPT 150)



LOCK & RIDE RATCHETING RHINO GRIP

- » 2881575 • **\$90⁹⁹**
ALL RANGER MODELS (EXCEPT 150)



LOCK & RIDE RHINO GRIP XLR **NEW**

- » 2881574 • **\$62⁹⁹**
ALL RANGER MODELS (EXCEPT 150)



LOCK & RIDE RHINO GRIP XLR DOUBLES **NEW**

- » 2884108 • **\$94⁹⁹**
ALL RANGER MODELS (EXCEPT 150)



RHINO GRIP PRO REPLACEMENT RUBBER STRAPS (2)

- » 2884109 • **\$11⁹⁹**
RHINO GRIP PRO



RHINO GRIP XLR REPLACEMENT RUBBER STRAPS (2)

- » 2889204 • **\$11⁹⁹**
RHINO GRIP XL

COLD WEATHER

GET READY FOR WINTER
with plows and tracks.
See P. 48 for plow details.

POLARIS PLOW MODE

EXCLUSIVE TO RANGER XP 1000
RIDE COMMAND FOR 2020 AND 2021

RIDE COMMAND
7" DISPLAY

» 2884072 • \$1,999⁹⁹
XP 1000 '19-21, CREW XP 1000 '19-21,
CREW 1000 '20-21, 1000 '20-21

SEE
P. 34

PLOW MODE FUNCTIONALITY DOES NOT CONTROL HYDRAULIC LIFT AND ANGLE



PLOW IS AUTOMATICALLY LOWERED
WHEN SHIFTING INTO LOW



PLOW IS AUTOMATICALLY RAISED WHEN
SHIFTING INTO REVERSE



BACK DRAG MODE ALLOWS FOR PULLING
SNOW AWAY FROM BUILDINGS



PROSPECTOR PRO® TRACK MOUNTS

• Install this track system mounting hardware in place of tires and wheels. Tracks sold separately.

» 2889425 • \$649⁹⁹ **NEW**
XP 1000 '21, CREW XP 1000 '21, 1000 '21, CREW 1000 '21
FITS 2021 MODELS WITH NON-HIGH CLEARANCE A-ARMS

» 2889426 • \$649⁹⁹ **NEW**
XP 1000 WATERFOWL EDITION '21, CREW XP 1000 WATERFOWL EDITION '21,
XP 1000 BIG GAME HUNT EDITION '21, CREW XP 1000 BIG GAME EDITION,
XP 1000 HIGHLIFTER EDITION '21, CREW XP 1000 HIGHLIFTER EDITION '21
FITS 2021 MODELS WITH HIGH CLEARANCE A-ARMS

» 2882783 • \$649⁹⁹
XP1000 18-20, CREW XP1000 19-20, 1000 20, CREW 1000 '20
DOES NOT FIT HIGH LIFTER MODELS

» 2880071 • \$649⁹⁹
CREW 570-4 '15-21, 570 '14-21, 500 '17-21

PROSPECTOR PRO® TRACK

» 2880758 • \$6,449⁹⁹
570 FULL-SIZE 16-21 WITH EPS, 570-2 '14-21 WITH EPS, CREW 570-2 '14-21
WITH EPS
DOES NOT FIT HIGH LIFTER MODELS

» 2883313 • \$6,449⁹⁹
XP1000 '18-21 WITH EPS, CREW XP1000 '19-21 WITH EPS, 1000 20-21 WITH
EPS, CREW 1000 20-21 WITH EPS
DOES NOT FIT HIGH LIFTER MODELS

» 2880757 • \$6,449⁹⁹
XP1000 '18-21 WITH OUT EPS, CREW XP1000 '19-21 WITH OUT EPS, 1000 20-21
WITH OUT EPS, CREW 1000 20-21 WITH OUT EPS, 570 FULL-SIZE 16-21 NON
EPS, 570-2 '14-21 WITH OUT EPS, CREW 570-2 '14-21 WITH OUT EPS

If using Glacier® Pro Plow System with tracks, Track Plow Extension is required (2889267)

POLARIS-SPECIFIC GEARING PROVIDES 1:1 RATIO TO:

- Minimize track slip, providing better climbing ability and improved traction in deep snow
- Improve top speed over prior models by approximately 5%
- Reduce operating RPM for a quieter ride
- Improve driveline durability, which allows vehicle to run at a lower RPM, decreasing engine wear

Polaris Exclusive optimized hub geometry that minimizes feedback and eases steering effort

New front dual stabilizer for improved stability

Lightweight design provides for better flotation, eases steering effort, and provides better vehicle control



For year-round use, Polaris recommends the use of Intake Update Kit (2880673) on any Ranger XP 1000 '17, Ranger XP 1000 CREW '14-18 with tracks installed. To keep intake system working optimally, this kit pre-filters out fine snow and dust.

Otter®

FEATURES

- Fits 1-2 people
- 26.5 square ft.
- Set up dimensions: 67" L x 59 1/2" W x 78 1/2" H
- Cover included
- 2 top sealable vents
- Front entry door with dual coil zippers
- 2 sewn-in TPU crack resistant windows
- Insulated corners for complete coverage
- Interior draft skirt with extra-long perimeter



WARRANTY

POLARIS RANGER COMPATIBLE MODELS



XP 1000 '17-21, CREW XP 1000 '17-21,
CREW 1000 '20-21, 1000 '20-21



CREW 570 FULL SIZE '18-21,
570 FULL SIZE '17-21

LOCK & RIDE
Polaris XT Pro Lodge
by **Otter**

» 2882199 • \$1,289⁹⁹

VEHICLE WITH TRACKS WILL REDUCE SITTING SPACE IN HOUSE SLIGHTLY



LOCK & RIDE Easy On & Off



Room for Ice Fishing Gear

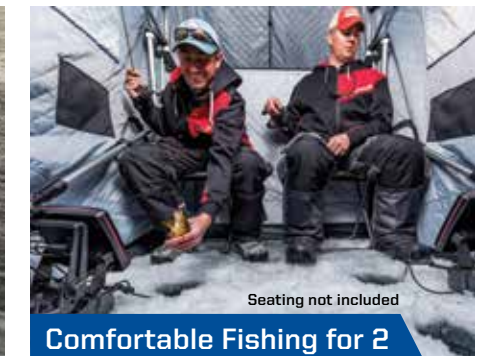

Seating not included

Comfortable Fishing for 2

EASY SET UP

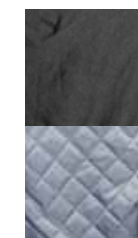
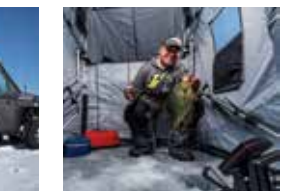

OUTER SHELL
Provides outstanding wind and light blocking capabilities

INNER LINING
The full thermal quilted inner shell provides higher lofting while locking in heat and virtually eliminating condensation



LIGHTWEIGHT
Oversized square tube aluminum frame with anodized receiver tubes and ultra-glide operation



"The full-thermal Otter® Ice House from Polaris sets up in minutes, is spacious enough for two anglers to fish in comfort and stows quickly on the back of your RANGER. It is the premium shelter solution for ice anglers that rely on their Polaris RANGER for mobility out on the ice."

- James Holst, InDepth Outdoors

GLACIER[®] PRO HD

PLOW SYSTEM

HYDRAULIC CONTROL FOR EXTREME SNOW REMOVAL

A robust frame and tough blades, combined with a convenient hydraulic angle system, allow your Glacier[®] Pro HD to move serious snow while you remain comfortable. Thanks to Lock & Ride technology, the Pro HD comes standard with a convenient kickstand attachment to the plow frame, giving you the easiest attachment.



3-SEAT & CREW GLACIER[®] PRO HD

» 72" Blades

» Choice of poly or steel

» Hydraulic lift & angle system option



2-SEAT & CREW 570 FULL-SIZE & CREW GLACIER[®] PRO HD

» 72" OR 66" Blades

» Choice of poly or steel

» Hydraulic angle system option

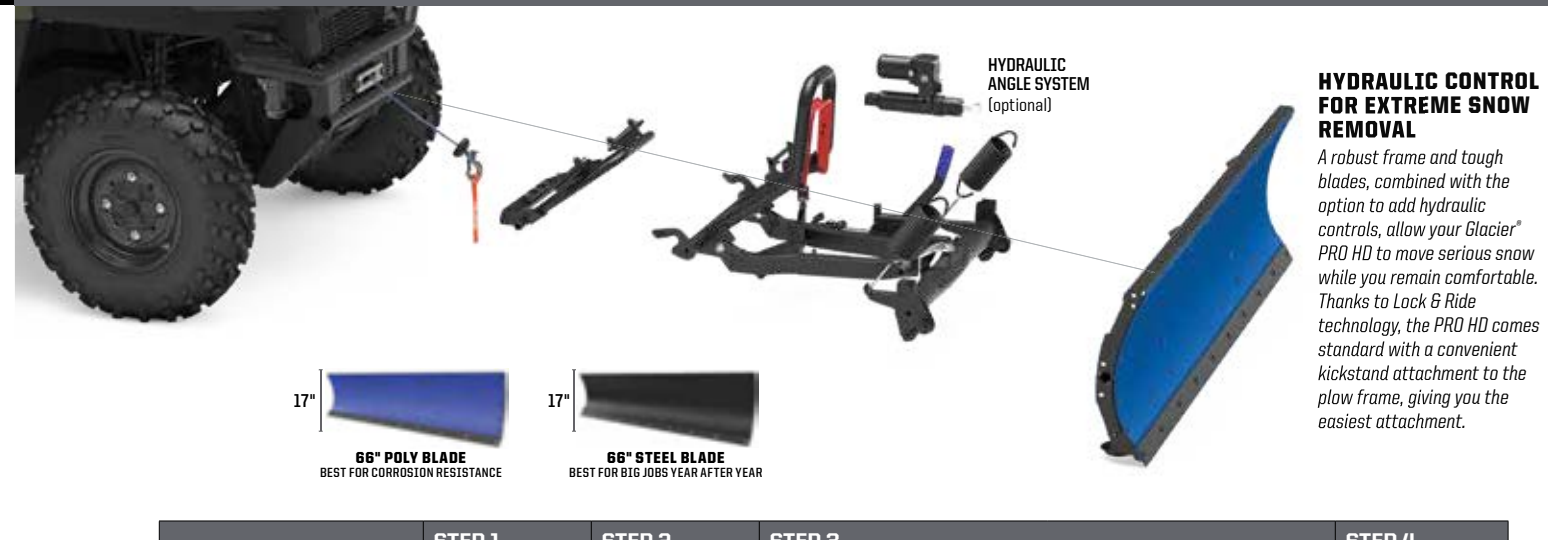

HYDRAULIC CONTROL FOR EXTREME SNOW REMOVAL

A robust frame and tough blades, combined with the option to add hydraulic controls, allow your Glacier[®] PRO HD to move serious snow while you remain comfortable. Thanks to Lock & Ride technology, the PRO HD comes standard with a convenient kickstand attachment to the plow frame, giving you the easiest attachment.

MODELS	STEP 1 SELECT A MOUNT	STEP 2 SELECT A FRAME	STEP 3 SELECT PLOW CONFIGURATION	STEP 4 SELECT A BLADE
XP 1000 '18-21 CREW XP 1000 '19-21 1000 '20-21 CREW 1000 '20-21	Not Required Integrated into Factory Bumper NON EPS RANGER 1000 REQUIRES FRONT BUMPER	TOP SELLER 2883255 \$1,409 ⁹⁹ Track Extension 2879871 \$609 ⁹⁹ Replacement T Shear Pin 2204829 \$7 ⁹⁹ Glacier[®] PRO HD Kickstand System 2207382 \$30 ⁹⁹	Hydraulic Lift System 2883410 \$609 ⁹⁹ Glacier[®] Pro HD Plow Hydraulic Angle System 2885103 \$669 ⁹⁹ Power Controller Required for hydraulic components 2883247 \$269 ⁹⁹	Polaris PRO HD 6,000 lb. Winch 2882710 \$1,229 ⁹⁹ Polaris PRO HD 4,500 lb. Winch 2882711 \$1,099 ⁹⁹ Power Controller Winch Adapter 2884159 \$69 ⁹⁹ TOP SELLER 72" Steel 2879874 \$609 ⁹⁹

MODELS	STEP 1 SELECT A MOUNT	STEP 2 SELECT A FRAME	STEP 3 SELECT PLOW CONFIGURATION	STEP 4 SELECT A BLADE
570 FULL-SIZE '16-21 CREW 570 FULL-SIZE '16-21	2880261 \$339 ⁹⁹	TOP SELLER 2880260 \$609 ⁹⁹ Track Extension 2880267 \$339 ⁹⁹ Replacement Shear Pin 2205527 \$10 ⁹⁹	Glacier[®] Pro HD Plow Hydraulic Angle System 2885104 \$799 ⁹⁹ Power Controller Required for hydraulic components 2879227 \$59 ⁹⁹	Polaris PRO HD 4,500 lb. Winch 2882238 \$1,099 ⁹⁹ 72" Steel 2880270 \$609 ⁹⁹ 66" Poly 2880269 \$539 ⁹⁹ 66" Steel 2880268 \$469 ⁹⁹
570/500/ETX '10-21 CREW 570 '10-21 LI-ION EV & EV '15-21	2880261 \$339 ⁹⁹		Glacier[®] Pro HD Plow Hydraulic Angle System 2885104 \$799 ⁹⁹ Power Controller Required for hydraulic components 2879227 \$59 ⁹⁹	Polaris PRO HD 4,500 lb. Winch 2882238 \$1,099 ⁹⁹ 72" Steel 2880270 \$609 ⁹⁹ 66" Poly 2880269 \$539 ⁹⁹ 66" Steel 2880268 \$469 ⁹⁹

SELECT ACCESSORIES

PLOW BLADE SNOW DEFLECTOR

- » 72" • 2858541 • \$89⁹⁹
- » 66" • 2879866 • \$114⁹⁹
- » 60" • 2871808 • \$89⁹⁹

HEAVY DUTY SNOW PLOW DEFLECTOR

- » 72" • 2884160 • \$194⁹⁹

QUICK RELEASE SKID SHOES

- Helps prevent blade wear
- Hardened steel for industrial strength
- » 2205223 • \$43⁹⁹

COIL SPRING SPACER

- Keep the front end of the vehicle up and improve ride quality when using a plow on strut or A-arm vehicles
- » 2872655 • \$24⁹⁹

WEAR BARS

- Protect your plow blade and minimize wear on the actual blade by installing Wear Bars
- » 72" • 2204976 • \$74⁹⁹
- » 66" • 2879867 • \$74⁹⁹
- » 60" • 2877243 • \$48⁹⁹

QUICK RELEASE SKID SHOES

- Helps prevent blade wear
- Hardened steel for industrial strength
- » 2208864 • \$34⁹⁹

PLOW MARKER

- Helps driver monitor plow blade position
- Sold in pairs
- » 2872726 • \$43⁹⁹

PLOW LINK

- » 2204974 • \$23⁹⁹

GLACIER[®] HD

PLOW SYSTEM

MAKE QUICK WORK OF THE SMALLER JOBS

Move some snow with the sturdy and capable Glacier[®] HD plow system, and discover why a major snowfall can be the highlight of your week. With a robust frame, beefy poly and steel blade options, convenient Lock & Ride mounting and dismounting and amazing value, Glacier[®] HD is a great choice in the dead of winter.



3-SEAT & CREW GLACIER[®] HD

» 72" OR 66" Blades

» Choice of poly or steel

» Manual angle system standard

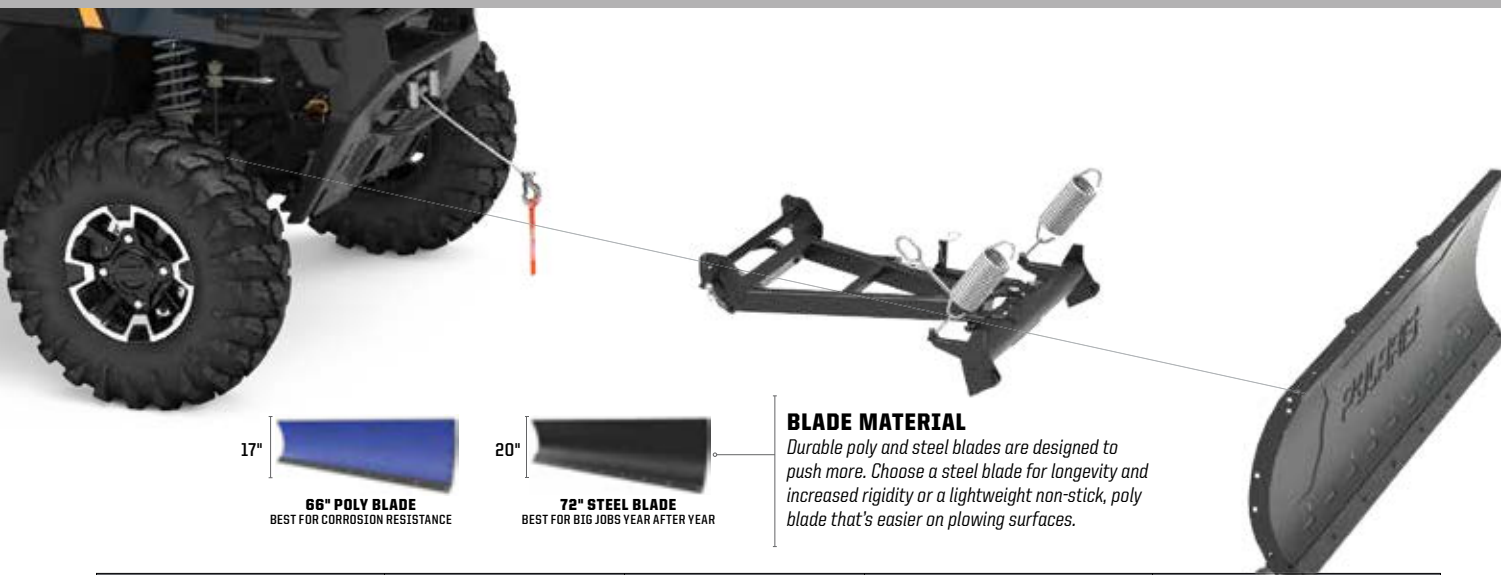

BLADE MATERIAL
Durable poly and steel blades are designed to push more. Choose a steel blade for longevity and increased rigidity or a lightweight non-stick, poly blade that's easier on plowing surfaces.

2-SEAT & CREW 570 FULL-SIZE & CREW

GLACIER[®] HD

» 66" Blades

» Choice of poly or steel

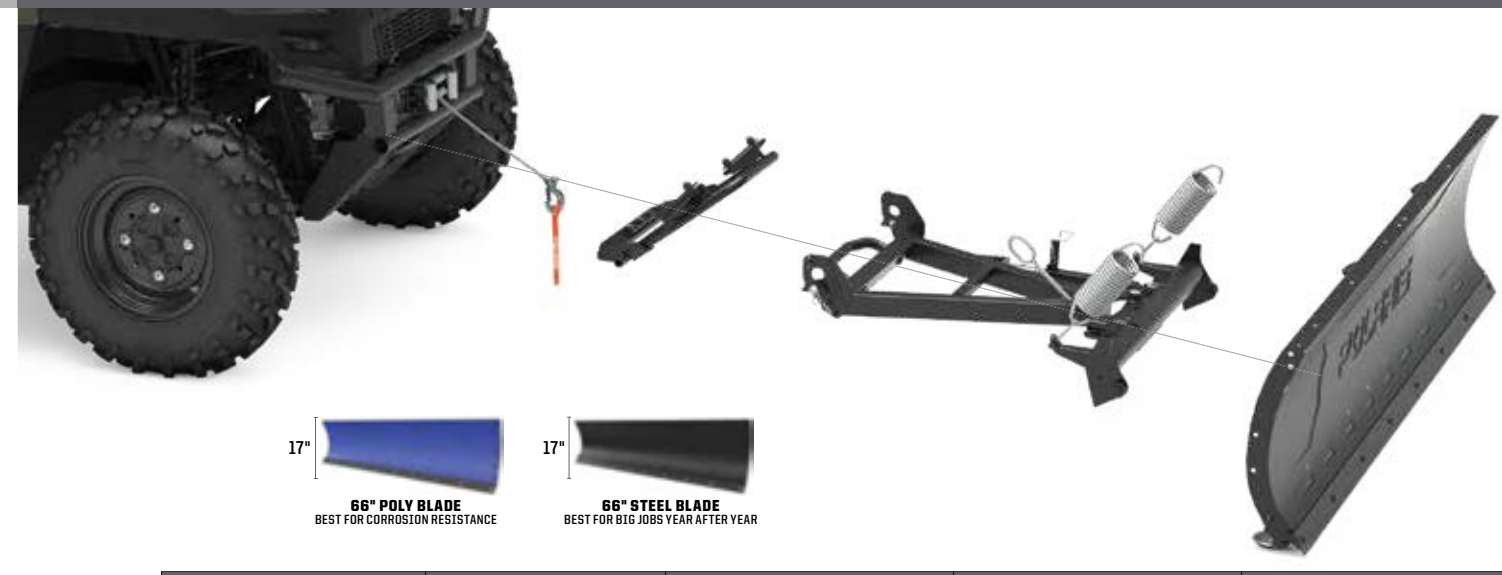

MODELS	STEP 1 SELECT A MOUNT	STEP 2 SELECT A FRAME	STEP 3 SELECT A LIFT METHOD	STEP 4 SELECT A BLADE
XP 1000 '18-21 CREW XP 1000 '19-21 1000 '20-21 CREW 1000 '20-21	Not Required Integrated into Factory Brushguard	TOP SELLER 2882927 \$609 ⁹⁹	Polaris HD 4,500 lb. Winch 2882714 \$809 ⁹⁹	72" Steel 2880270 \$609 ⁹⁹ 66" Poly 2880269 \$539 ⁹⁹ 66" Steel 2880268 \$469 ⁹⁹
NOT COMPATIBLE WITH 29" OR LARGER TIRES	NON EPS RANGER 1000 REQUIRES FRONT BUMPER	Replacement Shear Pin 2205527 \$10 ⁹⁹		

MODELS	STEP 1 SELECT A MOUNT	STEP 2 SELECT A FRAME	STEP 3 SELECT A LIFT METHOD	STEP 4 SELECT A BLADE
570 FULL-SIZE '16-21 CREW 570 FULL-SIZE '16-21	2879105 \$209 ⁹⁹	TOP SELLER 2882927 \$609 ⁹⁹	Polaris HD 3,500 lb. Winch 2881669 \$609 ⁹⁹	66" Poly 2880269 \$539 ⁹⁹ 66" Steel 2880268 \$469 ⁹⁹
570/500/ETX '10-21 CREW 570 '10-21 LI-ION EV & EV '15-21	2879105 \$209 ⁹⁹	Replacement Shear Pin 2205527 \$10 ⁹⁹	Polaris HD 3,500 lb. Winch 2881669 \$609 ⁹⁹	66" Poly 2880269 \$539 ⁹⁹ 66" Steel 2880268 \$469 ⁹⁹

SELECT ACCESSORIES

WEAR BARS

- Protect your plow blade and minimize wear on the actual blade by installing Wear Bars
- » 72" • 2204976 • \$74⁹⁹
- » 66" • 2879867 • \$74⁹⁹
- » 60" • 2877243 • \$48⁹⁹

PLOW BLADE SNOW DEFLECTOR

- » HD 72" • 2879875 • \$139⁹⁹
- » HD 66" • 2879868 • \$134⁹⁹
- » 72" • 2858541 • \$89⁹⁹
- » 66" • 2879866 • \$114⁹⁹
- » 60" • 2871808 • \$89⁹⁹

HEAVY DUTY SNOW PLOW DEFLECTOR

- » 72" • 2884160 • \$194⁹⁹

QUICK RELEASE SKID SHOES

- Helps prevent blade wear
- Hardened steel for industrial strength
- » 2208864 • \$34⁹⁹

COIL SPRING SPACER

- Keep the front end of the vehicle up and improve ride quality when using a plow on strut or A-arm vehicles
- » 2872655 • \$24⁹⁹

QUICK RELEASE SKID SHOES

- Helps prevent blade wear
- Hardened steel for industrial strength
- » 2208864 • \$34⁹⁹

PLOW MARKER

- Helps driver monitor plow blade position
- Sold in pairs
- » 2872726 • \$43⁹⁹

GLACIER[®] PLOW LINK

- » 2204974 • \$23⁹⁹

COMMON

3-SEAT & CREW / 2-SEAT & CREW

COOLERS

HUNT

COLD WEATHER

PLOWS

LIGHTING

WHEELS & TIRES



POLARIS ENGINEERED ADVANTAGES

MOUNTS PERFECTLY
Designed for your Polaris Engineered bumper, roof or other mounting point.

MAX PERFORMANCE
Validated to work as hard as your machine does.

DOESN'T OVERTAX
Trust it to work when you need it to.

PRO ARMOR



ADVANCED TECH

RIGID® lights are driven by Aluminum PCB Smart Boards™, 6063-T5 aircraft aluminum extruded housings and Tiger Drylac® UV protection polyester powdercoating.

EXCLUSIVE OPTICS

RIGID® lights feature impact-resistant polycarbonate lenses for a 100% water/dustproof seal.

RIGID® LIMITED LIFETIME WARRANTY

If you own a RIGID® light and it breaks, we will replace or repair it for life.*

RUGGED CONSTRUCTION

Pro Armor lights are designed to be big and beefy with an aggressive style all their own, and housed in IP67 marine-grade rated UV polyester powder coating.

MASSIVELY BRIGHT

Pro Armor builds bright lights designed for any riding experience. All that power is directed through heat dissipating aluminum for streamlined heat management.

LIGHT BAR TYPES



SR-SERIES PRO

Sleek, powerful, low-profile (under 2" tall). Lights extreme distances with low energy usage.
Available in 10" & 32"



D-SERIES PRO

Compact to fit almost anywhere with high output and low energy usage.
Available in Driving, Flood & Spot



SEE THE RIGID® LIGHTING BUYERS GUIDE AT [YOUTUBE.COM/POLARISORV](https://www.youtube.com/polarisorv) SEARCH "RIGID"



DUAL-ROW LED LIGHT BARS

The most spread and farthest illumination downrange. Easy to mount.
Available in Cube, 10", 20" & 30"



SINGLE-ROW LED LIGHT BARS

Powerful, compact, low-profile light bars with sleek look.
Available in 11", 33" & 40"



CUBE LED LIGHTS

Small size allows mounting in strategic locations for added lighting.
Available in Flood & Spot

LIGHT BAR OPTIONS

FOR COMPATIBILITY VISIT [POLARIS.COM/ShopRANGER](https://www.polaris.com/ShopRANGER)

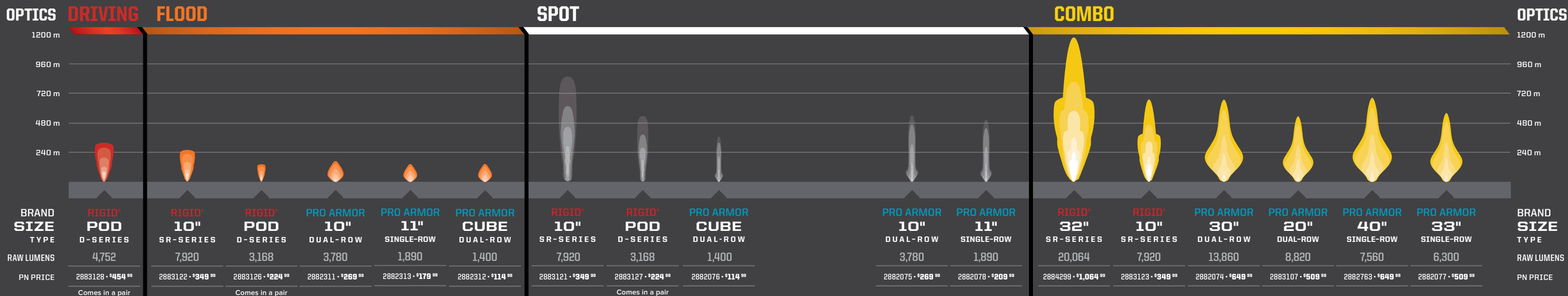

BUILD YOUR VISION

Consider the Optics, Angle & how you will use your vehicle to choose the right light or set of lights.

OPTICS LIGHT ANGLE	ACCENT	DRIVING (45°)	FLOOD (25°)	SPOT (10°)	COMBO (25°/10°)
DRIVING SPEED	All	Slow	Medium	Fast	Medium to fast
BEAM	Diffused glow	Extra-wide	Wide/Shorter	Concentrated/Long	Inner spot & outer flood
RECOMMENDED MOUNTING	Low/Wheel well	All points	Low &/or rear	High points	All points
TERRAIN & RIDING STYLE	Added style & personalization in any terrain	All riding & utility	Wide-open terrain or trails & utility	Trail & tight conditions	All riding & utility

COMPARE LIGHTS IN A REAL WORLD SETTING AT [POLARIS.COM/LIGHTING](https://www.polaris.com/lighting)

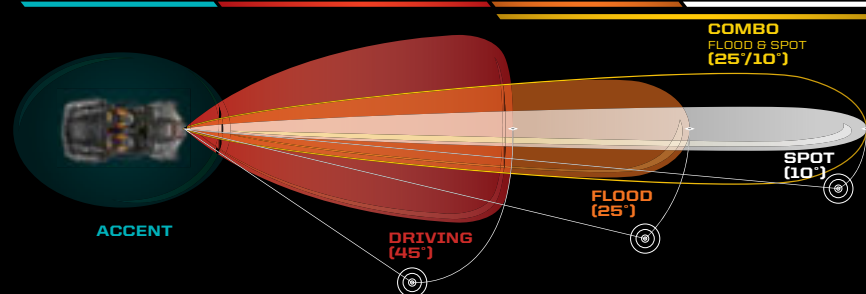

ADD A HARNESS TO MOUNT YOUR LIGHTS

MODEL	LIGHT BAR SET-UPS		
	1 LIGHT IN 1 LOCATION ON 1 SWITCH	2 LIGHTS IN 2 LOCATIONS ON 1 SWITCH	2 LIGHTS IN 2 LOCATIONS ON 2 SWITCHES
2014-2021 ALL MODELS EXCEPT XP 1000 '18-21, CREW XP 1000 '19-21, 1000 '20-21 & CREW 1000 '20-21	⚠ Requires Battery Connection Cable LIGHT BAR HARNESS 2882209 \$114 ⁹⁹	⚠ Requires Battery Connection Cable LIGHT BAR HARNESS 2882209 \$114 ⁹⁹ Y-HARNESS 2879860 \$23 ⁹⁹	⚠ Requires Battery Connection Cable LIGHT BAR HARNESS (x2) 2882209 \$114 ⁹⁹
XP 1000 '18-21, CREW XP 1000 '19-21, 1000 '20-21 & CREW 1000 '20-21	SEE P. 29 FOR WIRING CONNECTIONS		

IF INSTALLING REAR FACING LIGHT ON CREW MODELS, USE 2883854

1 LED LIGHT BAR WIRING HARNESS - REAR FACING CREW EXTENSION

» 2883854 • **\$25**⁹⁹
XP 1000 '20-21, CREW XP 1000 '19-21, CREW 1000 '20-21

⚠ BATTERY CONNECTION CABLES

- 3-SEAT & CREW**
 - » 3-SEAT • 2879388 • **\$44**⁹⁹
 - XP 1000 '17-18, XP 900 '19
 - » CREW • 2879685 • **\$74**⁹⁹
 - CREW XP 900/CREW XP 1000 '17-18
- 2-SEAT & CREW**
 - » 2-SEAT • 2879990 • **\$44**⁹⁹
 - 570 '15-21, 500 '17-21
 - » CREW • 2880929 • **\$74**⁹⁹
 - CREW 570-4 '15-21, 570 '15-21, 500 '17-21
 - » 570 • 2881684 • **\$43**⁹⁹
 - 570 FULL-SIZE '16-21



ADD A BEACON LIGHT FOR 360° ILLUMINATION
P. 27

COMMON

3-SEAT & CREW / 2-SEAT & CREW

COOLERS

HUNT

COLD WEATHER

PLOWS

LIGHTING

WHEELS & TIRES

* If RIGID® determines, in its sole discretion, that your product is defective in material or workmanship, RIGID® will honor your warranty claim. In some cases the product will be replaced, depending on the specific time frame of the purchase. If the product is repaired, all parts, labor, and return shipping may be covered by RIGID®.

KNOW YOUR TERRAIN



- Tread patterns optimized for extreme traction
- Ideal for both hard pack and loose trail



- Flexible "grippy" tread
- Aggressive side bite



- Provides traction and durability
- Built to perform in hard sand, jagged rocks or any other extreme terrain



- Extra deep treads
- Self-cleaning lugs



- Paddles provide traction and durability in soft sand
- Built to float on top of sand



- Industry leading anti-puncture side walls
- Purpose-built, long lasting tread patterns



- Handles extreme cold
- Holds shape and provides traction

SUPERIOR PERFORMANCE & DURABILITY

WAYS TO SHOP WHEELS & TIRES

LIFELONG PERFORMANCE

- Every tire is designed and constructed with longevity in mind
- 3,000+ mile rated (4,828 kilometers)

PREMIUM PROTECTION

- Pro Armor makes tires with extra protection exactly where it's needed most—the sidewall
- Triple-belted sidewalls keep your tires more resistant so you can keep going

TOUGHEST TIRES

- Higher ply ratings mean added protection
- Pro Armor builds 8 or 10-ply rated tires for higher puncture-resistance

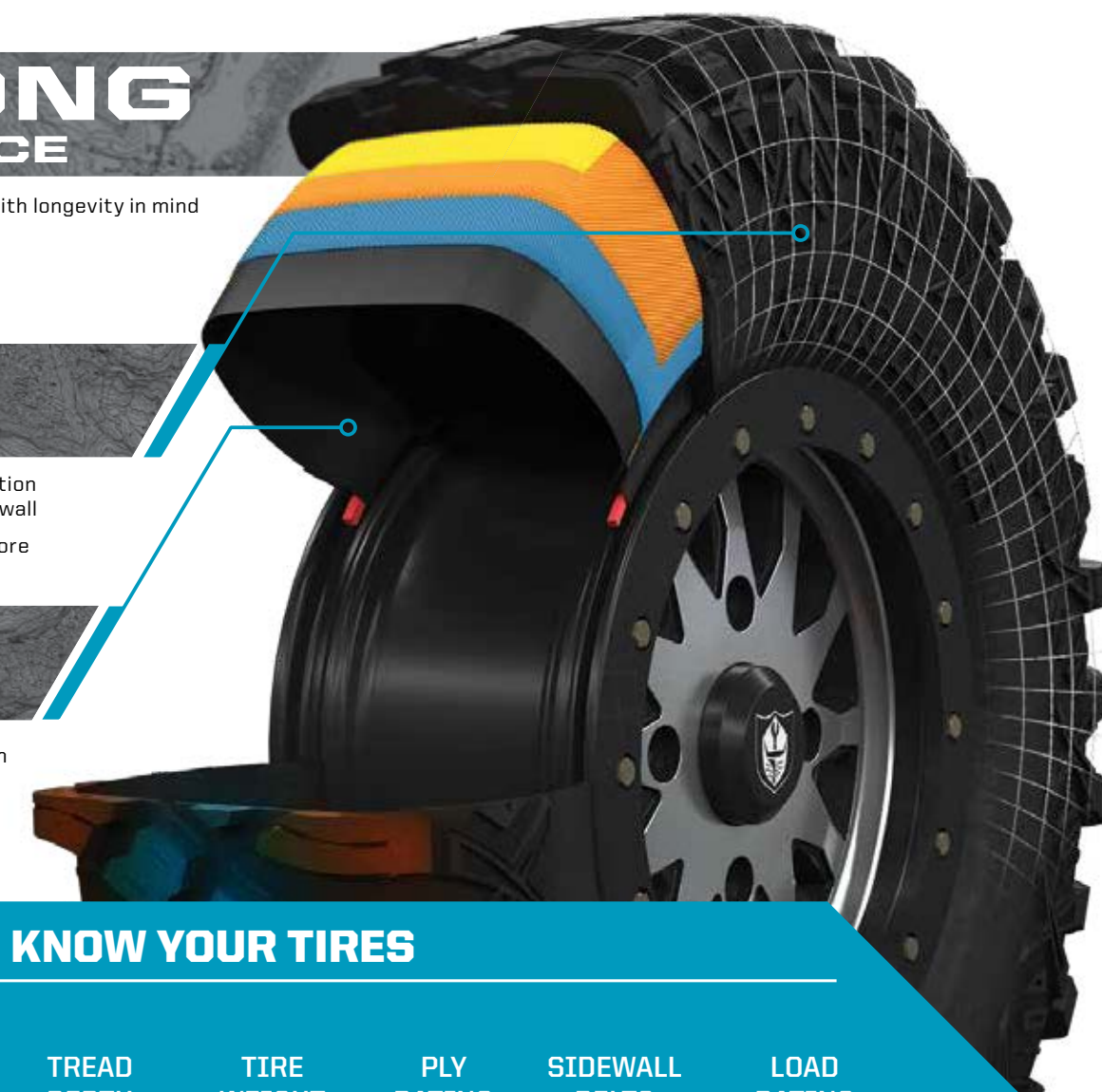

KNOW YOUR TIRES

DIMENSIONS			TREAD DEPTH	TIRE WEIGHT	PLY RATING	SIDEWALL BELTS	LOAD RATING
TIRE HEIGHT	TIRE WIDTH	WHEEL DIAMETER					
32" x 9"	R15	FRONT/REAR	30 mm	41 lbs	10	3	1,320 lbs
Part Number • Price							
USAGE Where can you use the tire			TREAD DEPTH Deeper treads have more grip in all conditions	TIRE WEIGHT A lighter tire makes for improved vehicle performance	PLY RATING Indicates tire puncture-resistance	SIDEWALL BELTS Increase your resistance to sidewall punctures	LOAD RATING How much weight can the tire handle

TIRES BY SIZE

26"	27"	28"	29"
ATTACK	MUD XC	CRAWLER XR	DUAL-THREAT
DUAL-THREAT	PRESERVE	HARVESTER	MUD XC
	HARVESTER	ATTACK 2.0	HD-K
		CRAWLER XG	

TIRES BY TERRAIN

TRAIL	ROCK	DESERT	MUD	UTILITY	SNOW
HARVESTER	CRAWLER XR	CRAWLER XR	MUD XC	HARVESTER	HARVESTER
PRESERVE	CRAWLER XG	CRAWLER XG		PRESERVE	XD-K
XD-K	DUAL-THREAT	ATTACK		XD-K	ATTACK
CRAWLER XR		ATTACK 2.0		HD-K	ATTACK 2.0
CRAWLER XG		DUAL-THREAT			HD-K
MUD XC					
ATTACK					
ATTACK 2.0					
DUAL-THREAT					
HD-K					

WHEELS BY SIZE

14"	15"
40-SERIES (9 TIRE OPTIONS)	50-SERIES (3 TIRE OPTIONS)
4201 (AMPLIFY)	5201 (CYCLONE)
4202 (BUCKLE)	5202 (FLARE)
4301 (COMBAT)	4301 (HALO)
4203 (REBLR)	5203 (HEXLR)
4204 (SHACKLE)	5204 (WYDE)
4205 (SIXR)	
HD DUAL	

KNOW YOUR WHEELS

STEP 1: SELECT YOUR SERIES

4 = 40-SERIES 5 = 50-SERIES

STEP 2: CHOOSE YOUR LOAD RATING

1 = <800 lbs 2 = 801 - 1,300 lbs 3 = 1,301 - 1,600+ lbs

STEP 3: PICK YOUR STYLE

OFFSET / BEADLOCK / COLOR

INCREASE OFFSET FROM STOCK = NARROWER STANCE
DECREASE OFFSET FROM STOCK = WIDER STANCE

TIRES

THE RIGHT TIRES

FOR WORK. Pro Armor Utility Tires are built to provide exactly what you need for your application. Need a high-kilometer work horse? We've got it. Need a turf-friendly tire with low-impact? We've got those too. Looking for the most extreme puncture resistance? Check.

"We use our RANGER every day around the farm. We put the Pro Armor HARVESTER Tires on last fall. We love them! We have received better traction as well as a gentler and quieter ride compared to the stock tires whether around the yard or out to the fields. They are so gentle on the lawn; we don't worry about driving the kids anywhere around the farm. We've had them on for a year and can't even see wear and tear, these are the best tires for my RANGER."

- BOB S., BARRON, WISCONSIN

PICKING THE RIGHT UTILITY TIRE

UTILITY FEATURE	HARVESTER	PRESERVE	XD-K	HD-K
5,000 Mile / 8,047 Kilometer Rated Long life and performance	X	X		
10-Ply Rated Higher ply ratings means added protection	X	X	X	X
Low Impact Tread Easy on soil		X		
Heavy Duty Tread Aggressive tread pattern for all day work on farms or ranches	X		X	X
Turf-Friendly Easy on grass and farm yard	X	X		
Aramid Fiber Belt 5x times stronger than steel and lighter			X	X
Wide Range of Sizes For exactly how you want to use your machine	30", 28", 27", 26"	27", 26"	26"	29"



PRO ARMOR PRESERVE

- Turf-friendly for areas where low-impact from tire tread is needed
- Rounded profile and special tread pattern to limit footprint

	TREAD DEPTH	TIRE WEIGHT	PLY RATING	SIDEWALL BELTS	LOAD RATING
14" 27" x 10" R14 5416348 • \$249 ⁹⁹	16 mm	28 lbs	10	3	1,390 lbs
12" 26" x 8" R12 5416403 • \$229 ⁹⁹		24 lbs			855 lbs
12" 26" x 10" R12 5416402 • \$249 ⁹⁹		28 lbs			1,320 lbs



WHEEL SIZE
14" 12"



PRO ARMOR HARVESTER

- All-around work horse with tread life of 5,000 miles / 8047 km
- Tread pattern designed to withstand anything from the farmyard to the pastures and the trail
- With 10-ply, it can carry the load day in and day out

	TREAD DEPTH	TIRE WEIGHT	PLY RATING	SIDEWALL BELTS	LOAD RATING
14" 28" x 10" R14 5416347 • \$269 ⁹⁹	16 mm	34 lbs	10	3	1,320 lbs
14" 27" x 10" R14 5415965 • \$249 ⁹⁹		32 lbs			1,320 lbs
12" 26" x 8" R12 5416396 • \$229 ⁹⁹		24 lbs			855 lbs
12" 26" x 10" R12 5415966 • \$249 ⁹⁹		32 lbs			855 lbs



WHEEL SIZE
14" 12"



PRO ARMOR XD-K

- 26" Aramid fiber-belted tire to tackle any terrain
- Unique full-face tread design
- Harder durometer lugs promotes extended wear, increasing tire life

	TREAD DEPTH	TIRE WEIGHT	PLY RATING	SIDEWALL BELTS	LOAD RATING
12" 26" x 9" R12 5415756 • \$278 ⁹⁹	31.7 mm	28 lbs	10	3/1 Aramid Fiber Belt	855 lbs
12" 26" x 11" R12 5415757 • \$293 ⁹⁹		32 lbs			1,100 lbs



WHEEL SIZE
12"



PRO ARMOR HD-K **NEW**

- Designed to provide a smooth ride and aggressive traction in all riding terrains
- Triple belted sidewall provides extreme sidewall protection and extends the tire life
- Quad belt tread core offers superior protection and longer tread life

	TREAD DEPTH	TIRE WEIGHT	PLY RATING	SIDEWALL BELTS	LOAD RATING
14" 29" x 10" R14 5417507 • \$329 ⁹⁹	31.75 mm	40 lbs	10	3/1 Aramid	1,320 lbs



WHEEL SIZE
14"

COMMON

3-SEAT 8 CREW / 2-SEAT 6 CREW

COOLERS

HUNT

COLD WEATHER

PLOWS

LIGHTING

WHEELS & TIRES

TIRES



PRO ARMOR CRAWLER XR

- Wanna race? This tire grips it all, from the trail to the rocks
- Square block profile for even surface contact
- A tougher durometer than the XG to take on the toughest the trail has to offer

	TREAD DEPTH	TIRE WEIGHT	PLY RATING	SIDEWALL BELTS	LOAD RATING
14" 28" x 10" R14 5415536 • \$259 ⁹⁹	FRONT/REAR 16 mm	32 lbs	8	3	1,140 lbs



WHEEL SIZE
↑
14"
↓

XR

SINGLE DUROMETER

- Smaller lug height, added rigidity and lateral stability when cornering
- Unique lug design excels in hard-packed, fast terrain



PRO ARMOR CRAWLER XG

- Big or small, these tires crawl them all
- A soft, sticky compound makes this tire ideal for both rock crawling and desert running
- 8-ply, triple-belted ballistic sidewalls resist punctures

	TREAD DEPTH	TIRE WEIGHT	PLY RATING	SIDEWALL BELTS	LOAD RATING
15" 28" x 10" R15 5416346 • \$269 ⁹⁹	FRONT/REAR 20 mm	32 lbs	8	3	1,110 lbs



WHEEL SIZE
↑
15"
↓

WHAT CRAWLER ARE YOU?

XG

DUAL-DUROMETER

- Taller lug height
- Perfect balance between high-speed performance, durability and flex in order to grip slick rock

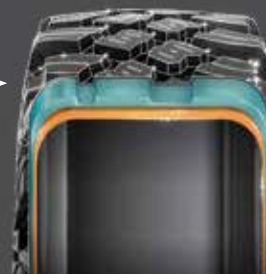

PRO ARMOR MUD XC

- Designed for the perfect mud-trail crossover for a smooth ride on the trail and aggressive traction in the mud
- Dual-compound technology with harder durometer lugs promote extended wear, increasing tire life
- 10-ply construction, means added protection in the toughest terrain

	TREAD DEPTH	TIRE WEIGHT	PLY RATING	SIDEWALL BELTS	LOAD RATING
14" 29" x 10" R14 5416946 • \$269 ⁹⁹	FRONT/REAR 30 mm	39 lbs	10	3	1,390 lbs
14" 27" x 9" R14 5416947 • \$249 ⁹⁹		30 lbs		3	1,170 lbs
14" 27" x 11" R14 5416948 • \$259 ⁹⁹		32 lbs		3	1,320 lbs



WHEEL SIZE
↑
14"
↓



PRO ARMOR DUAL-THREAT

- Dual-compound technology and radial construction offer performance in all terrains
- Softer durometer rubber on outer edge for overall superior grip and feel
- Harder durometer rubber in the middle for increased traction during acceleration and longer tread life

	TREAD DEPTH	TIRE WEIGHT	PLY RATING	SIDEWALL BELTS	LOAD RATING
14" 26" x 9" R14 5416340 • \$219 ⁹⁹	FRONT/REAR 16 mm	27 lbs	10	3	910 lbs
14" 26" x 11" R14 5416341 • \$229 ⁹⁹		30 lbs			1,110 lbs
14" 29" x 9" R14 5416342 • \$269 ⁹⁹		30 lbs			1,110 lbs
14" 29" x 11" R14 5416343 • \$279 ⁹⁹		35 lbs			1,320 lbs



WHEEL SIZE
↑
14"
↓

DUAL-COMPOUND = MORE GRIP + LONGER LIFE

Firmer Durometer Rubber = Longer Life



Softer Durometer Rubber = More Grip



PRO ARMOR ATTACK 2.0

- Engineered for excellent hard-pack performance
- Dual-compound technology and radial construction offer performance in all terrains.
- Tight tread pattern for quieter ride

	TREAD DEPTH	TIRE WEIGHT	PLY RATING	SIDEWALL BELTS	LOAD RATING
15" 28" x 10" R15 5416344 • \$269 ⁹⁹	FRONT/REAR 25 mm	32 lbs	10	3	1,110 lbs

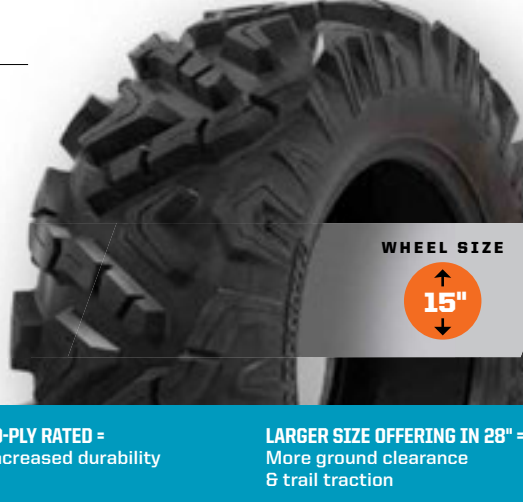

WHEEL SIZE
↑
15"
↓

TIGHTER TREAD PATTERN = Better traction in hard pack

DUAL-DUROMETER LUG = Increased grip & traction in rough terrain, smoother

10-PLY RATED = Increased durability

LARGER SIZE OFFERING IN 28" = More ground clearance & trail traction



PRO ARMOR ATTACK

- The best all-purpose tire for all-season traction in any terrain
- Unique, full-face tread design
- Harder durometer lugs promote extended wear, increasing tire life
- Wider spaced lugs provide more grip in softer terrain

	TREAD DEPTH	TIRE WEIGHT	PLY RATING	SIDEWALL BELTS	LOAD RATING
14" 26" x 9" R14 5415613 • \$189 ⁹⁹	FRONT/REAR 23 mm	28 lbs	8	3	910 lbs
14" 26" x 11" R14 5415614 • \$209 ⁹⁹		32 lbs			1,320 lbs



WHEEL SIZE
↑
14"
↓

COMMON

3-SEAT 8 CREW / 2-SEAT 6 CREW

COOLERS

HUNT

COLD WEATHER

PLOWS

LIGHTING

WHEELS & TIRES

KNOW YOUR TERRAIN



- Tread patterns optimized for extreme traction
- Ideal for both hard pack and loose trail



- Flexible "grippy" tread
- Aggressive side bite



- Provides traction and durability
- Built to perform in hard sand, jagged rocks or any other extreme terrain



- Extra deep treads
- Self-cleaning lugs



- Paddles provide traction and durability in soft sand
- Built to float on top of sand



- Industry leading anti-puncture side walls
- Purpose-built, long lasting tread patterns



- Handles extreme cold
- Holds shape and provides traction

WHEEL & TIRE SETS

↑
14"
↓

40-SERIES

UTILITY

	HARVESTER 28" 5,000 Mi/8,047 km	HARVESTER 27" 5,000 Mi/8,047 km	PRESERVE 27" 5,000 Mi/8,047 km
4201 (AMPLIFY) Accent	2883225 \$1,859 ⁹⁹	2882388 \$1,739 ⁹⁹	2883208 \$1,599 ⁹⁹
4201 (AMPLIFY) Matte Black	2883226 \$1,739 ⁹⁹	2882389 \$1,599 ⁹⁹	2883209 \$1,599 ⁹⁹
4202 (BUCKLE) Accent	2883220 \$1,859 ⁹⁹	2882383 \$1,739 ⁹⁹	2883203 \$1,739 ⁹⁹
4202 (BUCKLE) Matte Black	2883221 \$1,739 ⁹⁹	2882384 \$1,599 ⁹⁹	2883204 \$1,599 ⁹⁹
4301 (COMBAT) Accent BEADLOCKS PRE-MOUNTED			
4301 (COMBAT) Matte Black BEADLOCKS PRE-MOUNTED			
4203 (REBLR) Matte Black BEADLOCKS SOLD SEPARATELY			
4204 (SHACKLE) Accent	2883222 \$1,859 ⁹⁹	2882385 \$1,739 ⁹⁹	2883205 \$1,739 ⁹⁹
4204 (SHACKLE) Matte Black	2883223 \$1,739 ⁹⁹	2882386 \$1,599 ⁹⁹	
4205 (SIXR) Luster			
4205 (SIXR) Matte Black	2883224 \$1,739 ⁹⁹	2882387 \$1,599 ⁹⁹	2883207 \$1,599 ⁹⁹

DESERT/ROCK

MUD/TRAIL

CRAWLER XR 28" 3,000 Mi/4,828 km	MUD XC 29" 3,000 Mi/4,828 km	MUD XC 27" 3,000 Mi/4,828 km
2882394 \$1,739 ⁹⁹	2884265 \$1,849 ⁹⁹	2884272 \$1,739 ⁹⁹
2882395 \$1,599 ⁹⁹	2884266 \$1,715 ⁹⁹	2884273 \$1,612 ⁴⁹
2881343 \$1,739 ⁹⁹	2884260 \$1,849 ⁹⁹	2884267 \$1,739 ⁹⁹
2881344 \$1,599 ⁹⁹	2884261 \$1,715 ⁹⁹	2884268 \$1,612 ⁴⁹
2883213 \$2,139 ⁹⁹		
2883212 \$1,999 ⁹⁹		
2881386 \$1,999 ⁹⁹		
2881355 \$1,739 ⁹⁹	2884263 \$1,799 ⁹⁹	2884270 \$1,739 ⁹⁹
2881356 \$1,599 ⁹⁹	2884264 \$1,679 ⁹⁹	2884271 \$1,612 ⁴⁹
2881371 \$1,739 ⁹⁹		
2881372 \$1,599 ⁹⁹	2884262 \$1,679 ⁹⁹	2884269 \$1,599 ⁹⁹

BACKCOUNTRY/TRAIL

DUAL-THREAT 29" 3,000 Mi/4,828 km	DUAL-THREAT 26" 3,000 Mi/4,828 km	ATTACK 26" 3,000 Mi/4,828 km
2883146 \$1,859 ⁹⁹	2883138 \$1,669 ⁹⁹	2882390 \$1,489 ⁹⁹
2883147 \$1,739 ⁹⁹	2883139 \$1,539 ⁹⁹	2882391 \$1,359 ⁹⁹
2883148 \$1,859 ⁹⁹	2883140 \$1,699 ⁹⁹	2881335 \$1,599 ⁹⁹
2883149 \$1,739 ⁹⁹	2883141 \$1,539 ⁹⁹	2881336 \$1,479 ⁹⁹
2883219 \$2,269 ⁹⁹	2883217 \$2,059 ⁹⁹	
2883218 \$2,139 ⁹⁹	2883216 \$1,939 ⁹⁹	
		2881381 \$1,669 ⁹⁹
2883150 \$1,859 ⁹⁹	2883142 \$1,699 ⁹⁹	2881347 \$1,599 ⁹⁹
2883151 \$1,739 ⁹⁹	2883143 \$1,539 ⁹⁹	2881348 \$1,479 ⁹⁹
		2881359 \$1,599 ⁹⁹
2883152 \$1,739 ⁹⁹	2883144 \$1,539 ⁹⁹	2881360 \$1,479 ⁹⁹

↑
15"
↓

50-SERIES

TRAIL

DESERT/ROCK

	ATTACK 2.0 28" 3,000 Mi/4,828 km	CRAWLER XG 28" 3,000 Mi/4,828 km
5201 (CYCLONE) Accent	2883160 \$1,799 ⁹⁹	2883188 \$1,799 ⁹⁹
5201 (CYCLONE) Matte Black	2883159 \$1,669 ⁹⁹	2883187 \$1,669 ⁹⁹
5202 (FLARE) Accent	2883158 \$1,799 ⁹⁹	2883186 \$1,799 ⁹⁹
5202 (FLARE) Matte Black	2883157 \$1,669 ⁹⁹	2883185 \$1,669 ⁹⁹
5301 (HALO) Accent BEADLOCKS PRE-MOUNTED	2883162 \$2,169 ⁹⁹	2883190 \$2,169 ⁹⁹
5301 (HALO) Matte Black BEADLOCKS PRE-MOUNTED	2883161 \$2,059 ⁹⁹	2883189 \$2,059 ⁹⁹
5203 (HEXLR) Accent BEADLOCKS SOLD SEPARATELY	2883154 \$2,059 ⁹⁹	2883182 \$2,059 ⁹⁹
5204 (WYDE) Matte Black	2883155 \$1,669 ⁹⁹	2883183 \$1,669 ⁹⁹

2 WAYS TO PURCHASE

INDIVIDUAL WHEELS & TIRES
- OR -
COMPLETE SETS AS LISTED

VISIT Polaris.com/ProArmorRANGER
TO BUILD YOUR CUSTOM SET
AND VERIFY FITMENT

Exclusively at Polaris Authorized Dealers
or Polaris.com/ProArmorRANGER

REPLACEMENT CAPS

POLARIS CAPS

LUSTER	ALL WHEELS EXCEPT 5204 (WYDE) & 5203 (HEXLR)	1521509-410 • \$15 ⁹⁹
MATTE BLACK		1521509-521 • \$15 ⁹⁹
LUSTER	5203 (HEXLR)	1522243-410 • \$30 ⁹⁹
MATTE BLACK		1522243-458 • \$30 ⁹⁹
NEW HD MATTE BLACK	ALL WHEELS	5457498-458 • \$29 ⁹⁹

PRO ARMOR CAPS

LUSTER	ALL WHEELS EXCEPT 5204 (WYDE) & 5203 (HEXLR)	5453209-410 • \$15 ⁹⁹
MATTE BLACK		5453209-458 • \$15 ⁹⁹
MATTE BLACK	5204 (WYDE)	1523063-458 • \$13 ⁹⁹
LUSTER	5203 (HEXLR)	1523015-410 • \$15 ⁹⁹
MATTE BLACK		1523015-458 • \$15 ⁹⁹

LUG NUTS

LUG NUTS REQUIRED

12mm x 1.5 SPLINED LUG NUTS

16 LUG NUTS WITH WRENCH		2879332 • \$54 ⁹⁹
4 LUG NUTS WITHOUT WRENCH	ALL POLARIS RANGER 3-SEAT & CREW MODELS	2879331 • \$18 ⁹⁹
SPLINED LUG WRENCH		2204966 • \$12 ⁹⁹

3/8" - 24 HEX LUG NUTS

16 HEX LUG NUTS	ALL POLARIS RANGER 570 '20-21 MODELS	2877409 • \$43 ⁹⁹
4 HEX LUG NUTS		2876754 • \$18 ⁹⁹

TIRE SEALANT

P. 89

- » 946 mL • 2830484 • \$25⁹⁹
- » 3.8 LITER • 2830485 • \$89⁹⁹
- » 19 LITER • 2830486 • \$346⁹⁹
- » 19 LITER PUMP • 2830487 • \$163⁹⁹

COLBY VALVE SHORT ULTIMATE VALVE - 2 PACK

- » 2883292 • \$38⁹⁹

COLBY VALVE EMERGENCY VALVE - 2 PACK

- » 2883293 • \$38⁹⁹

COLBY VALVE BOX COMBO

- Includes 8 Ultimate and 8 Emergency Valves
- » 2883294 • \$589⁹⁹

WHEELS



↑
15"
↓

↑
14"
↓

50-SERIES

- A 5201 (CYCLONE)**
WEIGHT: 17.1 lbs | LOAD RATING: 1,300 lbs | OFFSET: +4
ACCENT: FRONT/REAR 15" x 7" 1523184-266 \$179⁹⁹
MATTE BLACK: FRONT/REAR 15" x 7" 1523184-458 \$149⁹⁹
- B 5203 BEADLOCK (HEXLR) ○**
WEIGHT: 16 lbs | LOAD RATING: 1,300 lbs | OFFSET: +38
MATTE BLACK: FRONT/REAR 15" x 7" 1522435-458 \$309⁹⁹

- C 5301 BEADLOCK (HALO)**
WEIGHT: 17 lbs | LOAD RATING: 1,600 lbs | OFFSET: +38
ACCENT: FRONT/REAR 15" x 7" 1523282 \$299⁹⁹
MATTE BLACK: FRONT/REAR 15" x 7" 1523266 \$269⁹⁹
- D 5202 (FLARE)**
WEIGHT: 17.8 lbs | LOAD RATING: 1,300 lbs | OFFSET: +4
ACCENT: FRONT/REAR 15" x 7" 1523102-266 \$179⁹⁹
MATTE BLACK: FRONT/REAR 15" x 7" 1523102-458 \$149⁹⁹

- E 5204 (WYDE) ○**
WEIGHT: 13.5 lbs | LOAD RATING: 1,300 lbs | OFFSET: +55
MATTE BLACK: FRONT/REAR 15" x 7" 1522550-458 \$249⁹⁹

LUG NUTS ○ LUG NUTS REQUIRED SEE P. 61



40-SERIES

- F 4201 (AMPLIFY) ○**
FRONT WEIGHT: 13 lbs | LOAD RATING: 900 lbs | OFFSET: +4
REAR WEIGHT: 14 lbs | LOAD RATING: 1,300 lbs | OFFSET: -9
ACCENT: FRONT 14" x 7" 1522956-266 \$189⁹⁹
REAR 14" x 8" 1522957-266 \$209⁹⁹
MATTE BLACK: FRONT 14" x 7" 1522956-458 \$169⁹⁹
REAR 14" x 8" 1522957-458 \$179⁹⁹
- G 4203 BEADLOCK (REBLR) ○**
FRONT WEIGHT: 13 lbs | LOAD RATING: 900 lbs | OFFSET: +4
REAR WEIGHT: 14.5 lbs | LOAD RATING: 1,300 lbs | OFFSET: -9
MATTE BLACK: FRONT 14" x 7" 1522238-458 \$279⁹⁹
REAR 14" x 8" 1522239-458 \$279⁹⁹

- H 4202 (BUCKLE) ○**
FRONT WEIGHT: 12.75 lbs | LOAD RATING: 900 lbs | OFFSET: +4
REAR WEIGHT: 13.5 lbs | LOAD RATING: 1,300 lbs | OFFSET: -9
ACCENT: FRONT 14" x 7" 1522544-266 \$189⁹⁹
REAR 14" x 8" 1522545-266 \$209⁹⁹
MATTE BLACK: FRONT 14" x 7" 1522544-458 \$169⁹⁹
REAR 14" x 8" 1522545-458 \$179⁹⁹
- I 4204 (SHACKLE) ○**
FRONT WEIGHT: 13 lbs | LOAD RATING: 900 lbs | OFFSET: +4
REAR WEIGHT: 14 lbs | LOAD RATING: 1,300 lbs | OFFSET: -9
ACCENT: FRONT 14" x 7" 1522546-266 \$189⁹⁹
REAR 14" x 8" 1522547-266 \$189⁹⁹
MATTE BLACK: FRONT 14" x 7" 1522546-458 \$169⁹⁹
REAR 14" x 8" 1522547-458 \$169⁹⁹

- J 4301 BEADLOCK (COMBAT)**
WEIGHT: 16 lbs | LOAD RATING: 1,600 lbs | OFFSET: +38
ACCENT: FRONT/REAR 14" x 7" 1523284 \$269⁹⁹
MATTE BLACK: FRONT/REAR 14" x 7" 1523283 \$259⁹⁹
- K 4205 (SIXR) ○**
FRONT WEIGHT: 10.5 lbs | LOAD RATING: 900 lbs | OFFSET: +4
REAR WEIGHT: 12.5 lbs | LOAD RATING: 1,300 lbs | OFFSET: -9
MATTE BLACK: FRONT 14" x 7" 1521507-521 \$149⁹⁹
REAR 14" x 8" 1521508-521 \$169⁹⁹
LUSTER: FRONT 14" x 7" 1521507-410 \$189⁹⁹
REAR 14" x 8" 1521508-410 \$199⁹⁹
- L HD DUAL BEADLOCK**
WEIGHT: 40 lbs | LOAD RATING: 1,600 lbs | OFFSET: +38
MATTE BLACK: FRONT/REAR 14" x 7" 1524022-458 \$359⁹⁹

KNOW YOUR WHEELS

STEP 1: SELECT SERIES

- 4 = 40-SERIES**
- 5 = 50-SERIES**

STEP 2: CHOOSE LOAD RATING

- 1 = <800 lbs**
- 2 = 801 - 1,300 lbs**
- 3 = 1,301 - 1,600+ lbs**

STEP 3: PICK STYLE

OFFSET / BEADLOCK / COLOR
INCREASE OFFSET FROM STOCK
= **NARROWER STANCE**
DECREASE OFFSET FROM STOCK
= **WIDER STANCE**



14" FORGED BEADLOCK RINGS			
	Only used on 4203 (REBLR)	PART #	
A	Voodoo Blue	1522244-619	\$114 ⁹⁹
B	Machined	1522244-266	\$114 ⁹⁹
C	White	1522244-133	\$114 ⁹⁹
D	Indy Red	1522244-293	\$114 ⁹⁹
E	Orange Crush	1522244-589	\$114 ⁹⁹
F	Matte Black - Replacement Only used on 4301 (Combat)	1523146-458	\$74 ⁹⁹

15" FORGED BEADLOCK RINGS			
	Only used on 5203 (HEXLR)	PART #	
A	Voodoo Blue	1522240-619	\$134 ⁹⁹
B	Machined	1522240-266	\$134 ⁹⁹
C	White	1522240-133	\$134 ⁹⁹
D	Indy Red	1522240-293	\$134 ⁹⁹
E	Orange Crush	1522240-589	\$134 ⁹⁹
F	Matte Black - Replacement Only used on 5301 (Halo)	1523147-458	\$79 ⁹⁹

**SEE P. 57 & 61
FOR HD PARTS**

COMMON
3-SEAT 8 CREW /
2-SEAT 6 CREW
COOLERS
HUNT
COLD WEATHER
PLOW
LIGHTING
WHEELS & TIRES

PERFORMANCE & COMFORT

THE RANGER 570 FULL-SIZE builds on its legendary reputation for getting the job done. With the industry's most complete lineup of Polaris Engineered Accessories, it's ready for anything your work demands.

ROOFS



SPORT ROOF

- Lightweight, rugged polyethylene construction
- Offers protection from sun and rain
- Does not work with Full Doors

» **TOP SELLER** 2877946 • **\$425⁹⁹**
570 FULL SIZE '17-21
» **CREW** • 2878755 • **\$709⁹⁹**
CREW 570 FULL SIZE '18-21



BIMINI SOFT TOP

- Tight-fitting canvas soft top with easy on/off design
- Lightweight 600 denier, solution-dyed polyester construction

» 2876963-067 • **\$134⁹⁹**
570 FULL SIZE '17-21

ROOF/REAR PANEL



CANVAS ROOF/REAR PANEL

- Constructed from premium, mold-resistant polyester with UV stabilizers
- Durable, heat-sealed vinyl window for crack resistance

» 2883471 • **\$469⁹⁹**
570 FULL SIZE '17-21

DOORS



RANGER CANVAS DOORS

- Constructed from premium, mold-resistant polyester with UV stabilizers
- Durable, heat-sealed vinyl window for crack resistance
- Zip-down windows for adjustable ventilation

» 2876962-067 • **\$619⁹⁹**
570 FULL SIZE '17-21
REQUIRES 2883471 CANVAS ROOF/REAR PANEL
DOES NOT FIT WITH 2877946 OR 2876963-067

DO MORE

COOLERS
SEE P. 42



HUNT
SEE P. 44



COLD WEATHER
SEE P. 46



LIGHTING
SEE P. 52



WINDSHIELDS



POLY WINDSHIELD

- Optical-grade, .236"-thick polycarbonate for outstanding protection and visibility

» **HARD COAT** • 2879489 • **\$669⁹⁹**
CREW 570 FULL SIZE '18-21

» **TOP SELLER** **GENERAL PURPOSE** • 2876958 • **\$539⁹⁹**
CREW 570 FULL SIZE '18-21, 570 FULL SIZE '17-21



LOOK & RIDE HALF WINDSHIELD

- Durable, optical-grade, .177"-thick polycarbonate for impact-resistance

• Half-height design delivers improved airflow for hot/dusty conditions

- Retains sporty, rugged look

» 2878756 • **\$269⁹⁹**
CREW 570 FULL SIZE '18-21, 570 FULL SIZE '17-21

REAR PANEL



POLY REAR PANEL

- Constructed from thick, impact resistant polycarbonate

- Delivers protection from the elements and a quieter ride
- Scratch-resistant for years of clear vision

• Contoured design eliminates perimeter framework for full rearward visibility
» 2878165 • **\$339⁹⁹**
CREW 570 FULL SIZE '18-21, 570 FULL SIZE '17-21

LOOK & RIDE ADD STORAGE TO YOUR RANGER 570 P. 74

WINCHES

FEATURES	PRO PRO HEAVY DUTY SERIES	HD HEAVY DUTY SERIES	 WARRANTY
RAPID ROPE RECOVERY	STANDARD	NOT AVAILABLE	
AUTO STOP TECHNOLOGY	STANDARD	OPTION	
WINCH LINE	SYNTHETIC ROPE	STEEL CABLE	
FAIRLEAD	ALUMINUM	STEEL ROLLER	
CONTROL	WIRELESS STANDARD, WIRED OPTION	WIRED STANDARD, WIRELESS OPTION	
MODEL	4,500 LB.	3,500 LB.	ADD REQUIRED CABLES
570 FULL-SIZE '16-21 CREW 570 FULL-SIZE '16-21	2882238 \$1,099 ⁹⁹	2881669 \$609 ⁹⁹	3-Seat Models: 2881684 \$43 ⁹⁹ Crew Models: 2880929 \$74 ⁹⁹

UPGRADE YOUR HD WINCH WITH THESE ACCESSORIES

WIRELESS REMOTE • Up to 50 ft. range with LED indicator • Direct plug and play operation » 2879316 • \$179⁹⁹ Works with 2881669	SYNTHETIC ROPE 3,500 LB. » 2878888 • \$104⁹⁹ 4,500 LB. » 2879187 • \$179⁹⁹ STEEL CABLE 3,500 LB. » 2878890 • \$59⁹⁹	AUTO STOP UPGRADE • Billeted aluminum • Replaces stock fairlead » 2881693 • \$134⁹⁹ Works with 2881669 SYNTHETIC ROPE REQUIRED	WIRED REMOTE CONTROL • Must order remote handle and socket together » REMOTE HANDLE 4013466 • \$79⁹⁹ » SOCKET 4014228 • \$55⁹⁹	POWER CONTROLLER • Control your winch and plow hydraulics directly from the shift knob » 2879227 • \$59⁹⁹ EV '11-21, CREW 570-4 '14-21, 570 FULL SIZE '17-21, 570 '14-21, 500 '11-21
--	--	--	--	--

MAKE IT YOURS.

WORK HARD AND GET IT DONE with Polaris Engineered Accessories for your RANGER. Start with the ultimate in all-season performance and comfort with the best cab components in the industry. Find everything you need to outfit your RANGER for the task at hand.



RANGER 570 HUNT

2881784	LOOK & RIDE Full Tip-Out Windshield - Glass	P. 70
2879967	Heater/Defrost Kit	P. 72
2882238	Polaris PRO HD 4,500 lb. Winch	P. 73
2882430	Kolpin Stronghold Gun Boot XL Transport	P. 44



RANGER 570 WORK

2881784	LOOK & RIDE Full Tip-Out Windshield - Glass	P. 70
2882247	Hinged Window Doors - Poly	P. 69
2882238	Polaris PRO HD 4,500 lb. Winch	P. 73
2881485	Cargo Bed Mat	P. 75



RANGER CREW 570-4 EPS RANCH

2881783	Glass Full Windshield, Clear	P. 70
2879963	LOOK & RIDE Canvas Door Set	P. 69
2881533	LOOK & RIDE Tool Rack	P. 75
2883424	Polaris Northstar Cooler - 30 Quart	P. 42



RANGER 500 TRAIL

2883236	LOOK & RIDE Poly 2-Seat Sport Roof	P. 68
2883320	LOOK & RIDE Half Windshield - Poly	P. 71
2883425	Polaris Northstar Cooler - 60 Quart	P. 42

SHOP ALL RANGER ACCESSORIES AT
[POLARIS.COM/ShopRANGER](https://www.polaris.com/ShopRANGER)

2-SEAT & CREW

570/500/EV

ROOFS & DOORS

WINDSHIELDS & REAR PANELS

CONVENIENCE & PROTECTION

WINCHES

STORAGE

ROOFS

DOORS

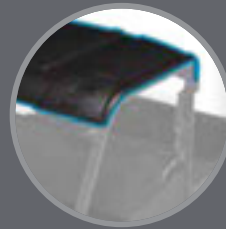

SEALED COVERAGE



REDUCE STANDING WATER

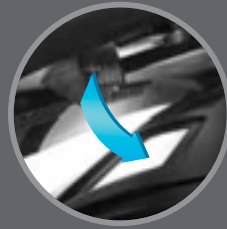

LOCK & RIDE
EASY AND FAST INSTALLATION

POLARIS ENGINEERED ADVANTAGES

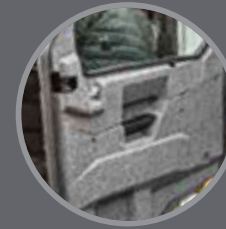

PREMIUM FEATURES

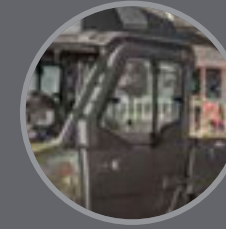

UNPRECEDENTED VENTILATION OPTIONS



EASY AND FAST INSTALLATION

POLY VS STEEL

- Water run-off
- Mounting features: easily add accessories & lighting
- Liner ready
- Lightweight

- Heavy duty/durable
- Low profile
- Unique style

SHIELD AGAINST DRIVING RAIN OR THE BLISTERING SUN. Choose from poly or steel and know that you are protected from the elements with a seamless integrated roof.

POLY Lightweight, durable and impact-resistant. A poly roof can take the abuse of a tight trail and still protect.

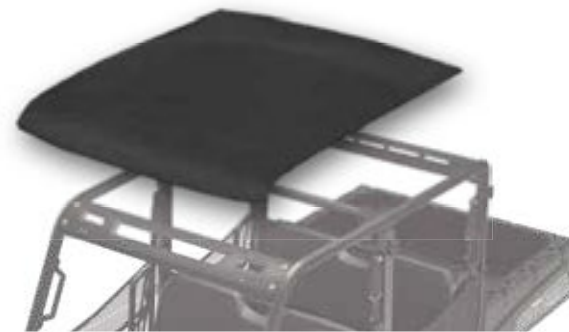

SPORT ROOF - POLY

- Provides shade, superior overhead protection
- Tough injection-molded design resists distortion from the elements
- Polaris Pursuit Camo offers effective visual camouflage in the field

- » 2-SEAT POLARIS PURSUIT CAMO • 2883237 • \$809⁹⁹
EV '15-21, 570 '15-21, 500 '17-21
- » **TOP BELLER** 2-SEAT BLACK • 2883236 • \$454⁹⁹
EV '15-21, 570 '15-21, 500 '17-21
- » **TOP BELLER** CREW BLACK • 2883238 • \$749⁹⁹
CREW 570-4 '15-21

STEEL For the ultimate in strength and protection.

HD ROOF - STEEL

- Stout 12-gauge steel construction
- Powdercoated finish for scratch and corrosion resistance
- Interior fabric liner provides sound reduction

- » 2-SEAT • 2879954 • \$809⁹⁹
EV '15-21, 570 '15-21, 500 '17-21

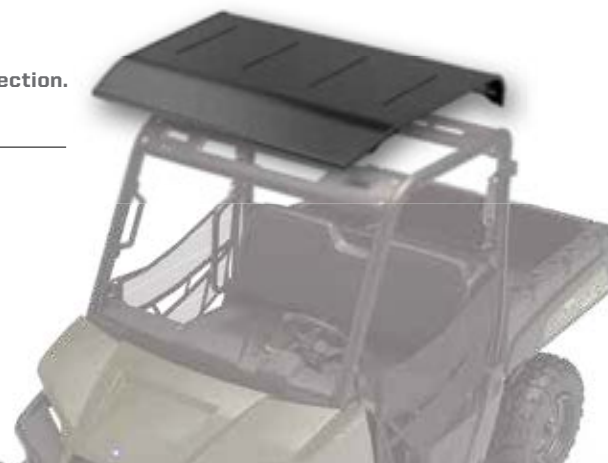

	POLY DOORS	CANVAS DOORS
FRONT DOORS (SET OF 2) EV '15-21, CREW 570-4 '15-21, 570 '15-21, 500 '17-21	<p>HINGED WINDOW</p> <ul style="list-style-type: none"> • A premium, door offering hinged window for customizable ventilation in the cab.  <p>Hinged Window - Poly Doors - Black 2882247 \$2,709⁹⁹</p>	<p>ZIP WINDOW</p> <ul style="list-style-type: none"> • Lightweight, durable protection with adjustable zipper ventilation and see-through bottom panel.  <p>Zip Window Doors - Canvas - Black 2879963 \$1,229⁹⁹</p>
REAR DOORS (SET OF 2) CREW 570-4 '15-21		 <p>Zip Window Doors - Rear - Canvas - Black 2879964 \$1,229⁹⁹</p>



WINDSHIELDS & REAR PANELS

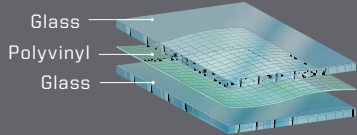

GLASS VS POLY

- Superior optical clarity (automotive level)
- Scratch-resistant
- Curved to fit, seals tight
- Cold weather/ heavy duty
- Wiper ready (Windshield only)

- Lightweight, flexible, easy to store/remove
- Impact-resistant
- Tight seal keeps out rain and dust

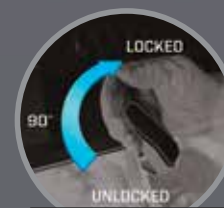
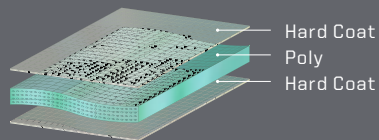

LOCK & RIDE

REVOLUTIONARY INSTALLATION

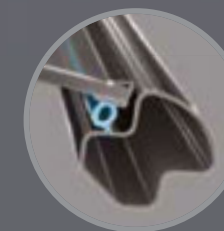

AIRTIGHT GASKET SEAL



VENTING OPTIONS



MULTI-FUNCTION FEATURES

WINDSHIELDS



Open
Closed



LOCK & RIDE TIP-OUT WINDSHIELD - GLASS

- Made of strong, optical-grade laminate safety glass
- Provides optimal visibility and the best protection from wind, inclement weather and off-road hazards
- Minimal perimeter framework for a low profile and full visibility
- Tip-out feature adjusts the windshield to an open position to enjoy airflow in the cab

» 2881784 • \$1,329⁹⁹
EV '15-21, CREW 570-4 '15-21, 570 '15-21, 500 '17-21

FULL WINDSHIELD - GLASS TOP SELLER

- Provides the highest level of scratch resistance

» 2881783 • \$809⁹⁹
EV '15-21, CREW 570-4 '15-21, 570 '15-21, 500 '17-21

LOCK & RIDE FULL WINDSHIELD - POLY TOP SELLER

- Durable, optical-grade, .236"-thick polycarbonate offers outstanding rider protection and visibility
- Windshield has minimal perimeter framework for full visibility

» 2883318 • \$469⁹⁹
EV '15-21, CREW 570-4 '15-21, 570 '15-21, 500 '17-21

LOCK & RIDE HALF WINDSHIELD - POLY

- Strong, durable polycarbonate half windshield delivers a combination of protection and airflow into the cab
- Half windshield offers protection from rain, sleet, spray, and off-road hazards

» 2883320 • \$249⁹⁹
EV '15-21, CREW 570-4 '15-21, 570 '15-21, 500 '17-21



FLIP-DOWN WINDSHIELD - HARD COAT POLY TOP SELLER

- 2 venting options: fully sealed or flip-down/remove upper half for some protection with maximum ventilation

» 2882178 • \$649⁹⁹
EV '15-21, CREW 570-4 '15-21, 570 '15-21, 500 '17-21



LOCK & RIDE VENTED WINDSHIELD - HARD COAT POLY

- Frameless design for maximum visibility
- Added vents for airflow on a hot day or defrosting on a cold day

» 2883342 • \$709⁹⁹
EV '15-21, CREW 570-4 '15-21, 570 '15-21, 500 '17-21



LOCK & RIDE FULL WINDSHIELD - HARD COAT POLY TOP SELLER

- Durable, optical-grade, .236"-thick polycarbonate offers outstanding rider protection and visibility
- Windshield has minimal perimeter framework for full visibility

» 2883319 • \$609⁹⁹
EV '15-21, CREW 570-4 '15-21, 570 '15-21, 500 '17-21



LOCK & RIDE REAR PANEL - GLASS

- Durable, tempered laminate glass provides a high level of scratch resistance

» 2879965 • \$414⁹⁹
EV '15-21, CREW 570-4 '15-21, 570 '15-21, 500 '17-21



LOCK & RIDE REAR PANEL - POLY TOP SELLER

- Strong, .236"-thick polycarbonate provides outstanding impact and scratch resistance

» 2879812 • \$339⁹⁹
EV '15-21, CREW 570-4 '15-21, 570 '15-21, 500 '17-21

HARD COAT POLY // 30X MORE SCRATCH RESISTANT



REDUCE IN-CAB DUST SWIRL BY ADDING A REAR PANEL

With a windshield and roof installed, turbulent air develops behind the cab. Add a rear panel to reduce dust intrusion from this swirl.

CONVENIENCE & PROTECTION

CONVENIENCE FEATURES

CAB SEAL SYSTEM

» 2 SEAT • 2880508 • \$159⁹⁹
 EV '15-21, CREW 570-4 '15-21, 570 '15-21, 500 '17-21
 (INCLUDED WITH PREMIUM DOORS)

EPS SYSTEM (ELECTRIC POWER STEERING)

- Enjoy smooth, easy, precise, responsive automotive-quality power steering
- EPS provides a light steering feel in all situations, including low-speed maneuvering through challenging terrain

» 2879970 • \$1,739⁹⁹
 CREW 570-4 '15-21, 570 '15-21
 1824163 REQUIRED FOR 2016 AND NEWER 570 MODELS

HORN

» 2879273 • \$89⁹⁹
 EV '15-21, CREW 570-4 '15-21, 570 '15-21, 500 '17-21

AUXILIARY BATTERY KIT

» 2880555 • \$409⁹⁹
 EV '15-21
 REQUIRED FOR 12V ACCESSORIES ON EV

REVERSE WARNING ALERT

» 2880631 • \$109⁹⁹
 CREW 570-4 '15-21, 570 '15-21, 500 '17-21

SPEEDKEY®

» 2879988 • \$409⁹⁹
 CREW 570-4 '15-21, CREW 1000 '20-21, 570 '15-21

EV QUICK CHARGING SYSTEM

» 2880556 • \$809⁹⁹
 EV '15-21



FIELD TESTED INTERIOR

ADD SUPERIOR ALL-WEATHER FUNCTIONALITY and comfort to your RANGER with premium Polaris Engineered Accessories. Keep warm on the coldest of days with a heater kit and improve visibility with a Windshield Wiper and Washer System or Large Rear View Mirror.



8-VENT HEATER & DEFROST SYSTEM

» 2879967 • \$1,069⁹⁹
 CREW 570-4 '15-21, 570 '15-21
 ⚠ Requires Battery Connection Cable



LARGE REAR VIEW MIRROR

» 2879969 • \$89⁹⁹
 CREW 570-4 '15-21, CREW 1000 '20-21, 570 '15-21, 500 '17-21

WINDSHIELD WIPER & WASHER SYSTEM

• Use with Full Glass Windshield 2881783 only
 » 2879968 • \$669⁹⁹
 EV '15-21, CREW 570-4 '15-21, 570 '15-21, 500 '17-21
 ⚠ Requires Battery Connection Cable



STANDARD BRUSHGUARDS

PERFECT FOR: INCREASED PROTECTION AROUND LIGHTING AND FENDERS

FRONT



1 3/4" DIAMETER STEEL TUBE CONSTRUCTION

REAR



» FRONT • 2879973 • \$339⁹⁹ » REAR • 2879972 • \$269⁹⁹
 500 '17-20, 570 '15-20, CREW 570-4 '15-20, EV '15-20
 DOES NOT WORK WITH FLIP-DOWN POLY WINDSHIELD 2881919

ROCK GUARDS WITH STEP



- Durable, stamped plate steel construction
- Provides additional protection for side of vehicle
- Integrated boot scraper helps keep interior clean

» 2 SEAT • 2879974 • \$209⁹⁹
 500 '17-20, 570 '15-20, EV '15-20

WINCHES

FEATURES	PRO PRO HEAVY DUTY SERIES	HD HEAVY DUTY SERIES	<p>1 YR WARRANTY</p>
RAPID ROPE RECOVERY	STANDARD	NOT AVAILABLE	
AUTO STOP TECHNOLOGY	STANDARD	OPTION	
WINCH LINE	SYNTHETIC ROPE	STEEL CABLE	
FAIRLEAD	ALUMINUM	STEEL ROLLER	
CONTROL	WIRELESS STANDARD, WIRED OPTION	WIRED STANDARD, WIRELESS OPTION	
MODEL	4,500 LB.	3,500 LB.	ADD REQUIRED CABLES
570 '15-21 CREW 570-4 '15-21 500 '17-21 RANGER EV '19-21 REQUIRES AUXILIARY BATTERY KIT 2880555	<p>2882238 \$1,099⁹⁹</p>	<p>2881669 \$609⁹⁹</p>	<p>2-Seat Models: 2879990 \$44⁹⁹</p> <p>Crew Models: 2880929 \$74⁹⁹</p>

UPGRADE YOUR HD WINCH WITH THESE ACCESSORIES

WIRELESS REMOTE • Up to 50 ft. range with LED indicator • Direct plug and play operation » 2879316 • \$179 ⁹⁹ Works with 2881669	SYNTHETIC ROPE 4,500 LB. » 2879187 • \$179 ⁹⁹ 3,500 LB. » 2878888 • \$104 ⁹⁹	AUTO STOP UPGRADE • Billeted aluminum • Replaces stock fairlead » 2881693 • \$134 ⁹⁹ Works with 2881669 SYNTHETIC ROPE REQUIRED
--	---	--

UPGRADE YOUR CONTROLS HD OR PRO HD WINCHES

WIRED REMOTE CONTROL • Must order remote handle and socket together. » REMOTE HANDLE 4013466 • \$79 ⁹⁹ » SOCKET 4014228 • \$55 ⁹⁹	POWER CONTROLLER • Control your winch and plow hydraulics directly from the shift knob » 2879227 • \$59 ⁹⁹ EV '11-21, CREW 570-4 '14-21, 570 FULL SIZE '17-21, 570 '14-21, 500 '11-21
---	--

2-SEAT & CREW

570/500/EV

ROOFS & DOORS

WINDSHIELDS & REAR PANELS

CONVENIENCE & PROTECTION

WINCHES

STORAGE

STORAGE



LOCK & RIDE

EXCLUSIVE AND AVAILABLE ON ALL POLARIS VEHICLES, LOCK & RIDE ACCESSORIES LET YOU QUICKLY CHANGE FROM ONE TASK TO ANOTHER WITH HUNDREDS OF OPTIONS.

WITH THE FLIP OF A LEVER, LOCK & RIDE PLUNGERS USE OUTWARD PRESSURE TO EXPAND FOR A SECURE FIT.



LOCK & RIDE CARGOMAX SYSTEM

- Comes standard with a support bar that ties the two sides together for a sturdy cargo hold
- Adjustable utility hooks provide more options for hanging tools, cords or gear
- Two sides and a support bar included

» 2882177 • \$669⁹⁹

EV '15-21, CREW 570-4 '15-21, CREW 570 FULL SIZE '18-21, 570 FULL SIZE '17-21, 570 '15-21, 500 '17-21,



CARGO BED MAT

- Non-slip surface to better secure loads
- Protect the cargo bed from scratches and scuffs
- Lifts out and is easy to clean
- Can be cut to access factory tie-down cleats

» 2881485 • \$134⁹⁹

EV '11-21, CREW 570-4 '14-21, 570 '14-21, 500 '11-21



FIRE EXTINGUISHER HOLDER

- Quick-release strap allows for easy access

» 2882158 • \$114⁹⁹

EV '15-21, CREW 570-4 '15-21, CREW 1000 '20-21, 570 '15-21, 500 '17-21



UNDER SEAT STORAGE BOX

» 2880046 • \$134⁹⁹

EV '15-21, CREW 570-4 '15-21, 570 '15-21, 500 '17-21

RIDE & REPAIR ESSENTIALS KIT

» 2881207 • \$134⁹⁹

EV '11-21, CREW 570-4 '14-21, CREW 570 FULL SIZE '18-21, 570 FULL SIZE '17-21, 570 '14-21, 500 '11-21



LOCK & RIDE D-RINGS

- The most versatile Lock & Ride accessory - add as many as you need to secure your cargo with bungee cords or straps

» 2881545 • \$43⁹⁹

EV '11-21, CREW 570-4 '14-21, CREW 570 FULL SIZE '18-21, 570 FULL SIZE '17-21, 570 '14-21, 500 '11-21



LOCK & RIDE CHAINSAW MOUNT

» 2879354 • \$179⁹⁹

EV '11-21, CREW 570-4 '14-21, CREW 570 FULL SIZE '18-21, 570 FULL SIZE '17-21, 570 '14-21, 500 '11-21



LOCK & RIDE STORAGE BOX

- Rugged roto-molded construction locks for security and is water-resistant
- Low-profile design retains additional hauling capacity on top of vault
- Sliding drawer features foam padding and adjustable dividers
- Fits perfectly in the bed of your RANGER, pickup box or full-size SUV

» 2877033 • \$439⁹⁹

EV '11-21, CREW 570-4 '14-21, 570 '14-21, 500 '11-21



LOCK & RIDE TOOL RACK

- Attach on the inside or outside of the cargo bed

» 2881533 • \$269⁹⁹

EV '11-21, CREW 570-4 '14-21, CREW 570 FULL SIZE '18-21, 570 FULL SIZE '17-21, 570 '14-21, 500 '11-21

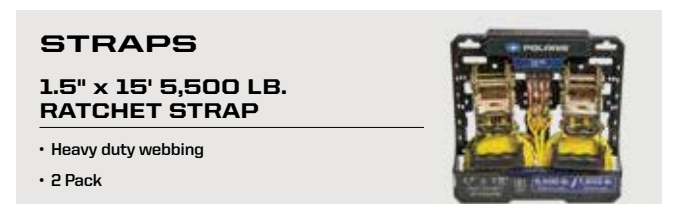

STRAPS

1.5" x 15' 5,500 LB. RATCHET STRAP

- Heavy duty webbing
- 2 Pack

» 2884031 • \$59⁹⁹



LOCK & RIDE QUICKSTRAP

- The quickest and most secure way to mount Polaris accessories

• Sold as a pair

» 2882187 • \$59⁹⁹

ALL COOLERS, RANGER CARGO BOXES



2" x 20' 10,000 LB. RATCHET STRAP

- Heavy duty webbing

» 2884032 • \$43⁹⁹



DO MORE

COOLERS

SEE P. 42



HUNT

SEE P. 44



COLD WEATHER

SEE P. 46



LIGHTING

SEE P. 52



HIT THE TRAILS

RANGER 150

ACCESSORIES



NEW
YOUTH CRAWLER TIRE

- Upgraded youth tire for added durability
- Increased ground clearance and performance

150 '19-21

		TREAD DEPTH	TIRE WEIGHT	PLY RATING	SIDEWALL BELTS	LOAD RATING
12"	22" x 8" R12	13mm	18 lbs	6	3	910 lbs
	5416945 • \$129 ⁹⁹					
12"	22" x 10" R12					
	5416944 • \$144 ⁹⁹					



FRONT & REAR BRUSHGUARD - SET

- Includes front and rear bumper
- Durable, E-coated steel construction

» BLACK • 2883287 • \$134⁹⁹

150 '19-21

NEW
YOUTH BUCKLE - BLACK

» FRONT • 12" x 7" • 1524114 • \$119⁹⁹

» REAR • 12" x 8" • 1524115 • \$129⁹⁹

150 '19-21

NEW
PRO ARMOR WHEEL & TIRE KIT:
YOUTH CRAWLER & BUCKLE

» 2885154 • \$959⁹⁹

150 '19-21



FULL-WINDSHIELD - POLY

- .125" clear poly carbonate
- Mounts with 4 simple p-clamps

» 2883288 • \$209⁹⁹

150 '19-21



HALF-WINDSHIELD - POLY

- 13" tall
- .125" clear poly carbonate
- Mounts with 4 simple p-clamps

» 2883298 • \$134⁹⁹

150 '19-21



SPORT ROOF - POLY

- Shields you from rain, snow, sun
- Easy install

» BLACK • 2883289 • \$269⁹⁹

150 '19-21

FOR THE LIFE OF YOUR RIDE

POLARIS ENGINEERS PARTS THAT PUSH THE LIMITS WITHOUT SACRIFICING STRENGTH AND DURABILITY.
We build our products so anyone with the right tools can maintain their vehicle from their own garage - and get them back on the trails where they belong.

MAINTENANCE TIP

BREAK-IN PERIOD

The break-in period for your new RANGER is the first 25 hours of operation, or the time it takes to use the first two tanks of fuel. No single action on your part is as important as a proper break-in period. Careful treatment of a new engine will result in more efficient performance and longer life for the engine.

NOTICE: Excessive heat build-up during the first three hours of operation will damage close-fitted engine parts. Do not operate at full throttle or high speeds for extended periods during the first three hours of use.

SEE OUR LATEST MAINTENANCE TIPS AT RANGER.POLARIS.COM/EN-CA/SELF-HELP

AIR FILTERS

A clogged air filter can restrict air flow to the engine leading to reduced engine performance, engine life or catastrophic failure.

BRAKE PADS

Maintaining and/or replacing brakes are critical to the safety and functionality of a vehicle. Brake pads should be checked for wear and oil or grease (petroleum products) contamination and brake discs should be checked for cracks, excessive corrosion or warping.

HALF SHAFT

Check for tear and punctures in the boot which can lead to CV joint wear that can contribute to axle failure.

BATTERIES

To ensure a battery maintains its level of charge when unused for extended periods of time or during freezing weather, the battery should be connected to a BatteryMINDER®, P. 88. Be sure to check for corrosion from the terminals to the ends of the cables.

DRIVE BELTS

Polaris Engineered belts deliver unmatched performance for your off-road vehicle. Developed and tested on all our engines for all environments and conditions. Check your belt for delamination, hour glassing and glazing.

BREAK-IN PERIOD

- Use lower gear (if available) while varying speeds and avoiding wide open throttle for 5-10 miles / 8-16 km
- If no low gear is available, vary at moderate speeds while avoiding wide open throttle for 50 miles / 80 km

OUR INVESTMENT

- 20,000 miles / 32,187 km of field testing
- Thousands of dyno hours
- 18+ months of development (3,000+ design hours) per belt
- 1200+ vehicle validation hours
- Collaboration with powertrain and clutch engineers

YOUR ADVANTAGE

- No clutch recalibration
- Less wear and tear due to heat
- Ensure maximum vehicle performance
- More time riding, less time wrenching
- Produced in collaboration with powertrain and clutch engineers to ensure a perfect fit, maximum performance and ultimate durability

OIL FILTERS

Change oil filters with every oil change to provide the best engine protection and keep the engine operating at peak performance.

FOLLOW RECOMMENDED SERVICE INTERVALS IN THE OWNER'S MANUAL

MAINTENANCE SCHEDULE

25 HRS / 250 Mi / 400 km

BREAK-IN MAINTENANCE

- ENGINE OIL:** CHANGE
- GENERAL LUBRICATION:** ALL FITTINGS, PIVOTS, CABLES, ETC.
- AIR FILTER:** INSPECT & REPLACE AS NEEDED
- EXHAUST SYSTEM:** INSPECT & CLEAN
INSPECT FOR LEAKAGE OR CARBON BUILD UP AT JOINTS
INSPECT & CLEAN SCREEN TYPE SPARK ARRESTOR

50 HRS / 500 Mi / 800 km

6 MONTHS

- EXHAUST SYSTEM:** INSPECT & CLEAN
INSPECT FOR LEAKAGE OR CARBON BUILD UP AT JOINTS
- INSPECT & CLEAN SCREEN TYPE SPARK ARRESTOR
- GENERAL LUBRICATION:** ALL FITTINGS, PIVOTS, CABLES, ETC.

100 HRS / 1000 Mi / 1600 km

12 MONTHS

- ENGINE OIL:** CHANGE
- DRIVE BELT:** INSPECT & ADJUST
REPLACE AS NEEDED
- TRANSMISSION FLUID:** CHANGE
- FRONT DRIVE FLUID:** CHANGE
- DRIVE BELT:** INSPECT & ADJUST
REPLACE AS NEEDED
- EXHAUST SYSTEM:** INSPECT & CLEAN
INSPECT FOR LEAKAGE OR CARBON BUILD UP AT JOINTS
INSPECT & CLEAN SCREEN TYPE SPARK ARRESTOR

150 HRS / 1500 Mi / 2400 km

18 MONTHS

- ENGINE OIL:** CHANGE
- BATTERY:** TEST, CLEAN, & REPLACE AS NEEDED
- DRIVE BELT:** INSPECT & ADJUST
REPLACE AS NEEDED
- TIRES:** INSPECT CONDITION & PRESSURE
- EXHAUST SYSTEM:** INSPECT & CLEAN
INSPECT FOR LEAKAGE OR CARBON BUILD UP AT JOINTS
INSPECT & CLEAN SCREEN TYPE SPARK ARRESTOR

200 HRS / 2000 Mi / 3200 km

24 MONTHS

- ENGINE OIL:** CHANGE
- BRAKE PADS & FLUID:** INSPECT & CLEAN
REPLACE AS NEEDED
- SPARK PLUGS:** INSPECT
REPLACE AS NEEDED
- EXHAUST SYSTEM:** INSPECT & CLEAN
INSPECT FOR LEAKAGE OR CARBON BUILD UP AT JOINTS
INSPECT & CLEAN SCREEN TYPE SPARK ARRESTOR

250 HRS / 2500 Mi / 4023 km

30 MONTHS

- ENGINE OIL:** CHANGE
- BATTERY:** TEST, CLEAN, & CHECK FLUID LEVEL
REPLACE AS NEEDED
- DRIVE BELT:** INSPECT & ADJUST
REPLACE AS NEEDED
- GENERAL LUBRICATION:** ALL FITTINGS, PIVOTS, CABLES, ETC.
- EXHAUST SYSTEM:** INSPECT & CLEAN
INSPECT FOR LEAKAGE OR CARBON BUILD UP AT JOINTS
INSPECT & CLEAN SCREEN TYPE SPARK ARRESTOR

300 HRS / 3000 Mi / 4828 km

36 MONTHS

- ENGINE OIL:** CHANGE
- AIR FILTER:** INSPECT & REPLACE AS NEEDED
- GEARCASES:** CHECK OIL LEVEL
- EXHAUST SYSTEM:** INSPECT & CLEAN
INSPECT FOR LEAKAGE OR CARBON BUILD UP AT JOINTS
INSPECT & CLEAN SCREEN TYPE SPARK ARRESTOR

CHECK YOUR OWNER'S MANUAL FOR ADDITIONAL RECOMMENDED SERVICE ITEMS AND VEHICLE-SPECIFIC TIMING

POLARIS

ENGINEERED PARTS & LUBRICANTS

FOR THE LIFE OF YOUR RIDE ONLY THE BEST WILL DO

To create the best oil for any terrain, we invest in rigorous testing to ensure our oil delivers the consistency and performance you demand.

WHAT COUNTS IN OIL TESTING:

1. Does it protect the engine at high temperatures?
2. Does it keep the engine free from carbon and buildup?
3. Does the oil hold its viscosity over time?

ENGINE CHECKPOINTS

Polaris engineers focus on key areas within the engine when evaluating engine oil and its ability to protect the life of your ride. Critical checkpoints include:



PISTON RINGS & RING LANDS: Extreme pressure to these parts require high lubricant film strength. Poor oxidative performance can lead to carbon and varnish buildup, which results in poor ring seal and fuel dilution of the oil. These can result in loss of power and accelerated engine wear.



ROD BEARINGS: Engine bearings on an oil with low film strength and thinner viscosity can lead to premature wear or even engine failure.



CAMSHAFT: Direct acting overhead camshafts are used on many Polaris engines. In this application the camshaft pushes directly on the valve, creating very high contact pressures compared to other camshaft configurations. These forces are so great that inferior oil can break down leading to increased wear and potential engine damage.

100 HR Polaris Endurance Dynamometer Engine Test Platform: RZR 1000 Oil Used: PS-4 5W50

SPECIFIC NEEDS, SPECIFIC OILS

PS-4 FULL-SYNTHETIC OIL

PS-4 is optimal for ambient operating temperatures of -40° F to 100° F

OUR FORMULATION

- Full-synthetic formula with wide, 5W-50 viscosity range
- Extreme cold weather flow and startup protection
- Maximum rust and corrosion protection
- Proprietary anti-wear additive system

YOUR ADVANTAGE

- All-weather engine protection
- Easy starting in all conditions
- Internal engine protection from extreme temperature fluctuations and periods of non-use or storage
- Reduced friction, protects cams, pistons, bearing and valvetrain components from wear

PS-4 EXTREME-DUTY FULL-SYNTHETIC OIL

PS-4 Extreme Duty is optimal for ambient operating temperatures of 0° F to 130° F

OUR FORMULATION

- Extreme high-temperature engine protection
- Full-synthetic formula with strong, 10W-50 Viscosity Range
- Protects against rust and corrosion of internal engine parts during periods of non-use or storage

YOUR ADVANTAGE

- High-strength film protection withstands extreme heat, stress and sustained high RPM conditions
- Extremely shear stable, maintains viscosity under heat and stress
- Protects engine from moisture that can build up inside the engine as a result of extreme temperature fluctuations

OIL CHANGE KITS

These convenient kits include everything you need to change your oil. The correct filter and oil volume for your vehicle.

PS-4	PS-4 EXTREME DUTY	
PART NUMBER	VEHICLE FITMENT	PART NUMBER
2202166	RANGER/RZR/SPORTSMAN 570, TWIN 600, TWIN 700, TWIN 800	2879004
2879323	RANGER, POLARIS GENERAL, RZR 900/1000, RS1	2879324
2877473	RANGER/ SPORTSMAN 300-500, SPORTSMAN/SCRAMBLER 500/850/1000	2878924
2881696	RZR TURBO	2881697

» 1 Quart 2876244 » 1 Gallon 2876245 » 16 Gallons 2876247 » 55 Gallon Drum 2876246 » 330 Gallon Tote 2878814

» 1 Quart 2878920 » 1 Gallon 2878919 » 16 Gallons 2879003 » 55 Gallon Drum 2879002 » 330 Gallon Tote 2879001

SUPERIOR ENGINE PROTECTION

- Polaris Engineered PS-4
- Leading Aftermarket Synthetic ATV/UTV Oil
- Leading Aftermarket ATV Oil
- National Brand Synthetic Diesel Oil

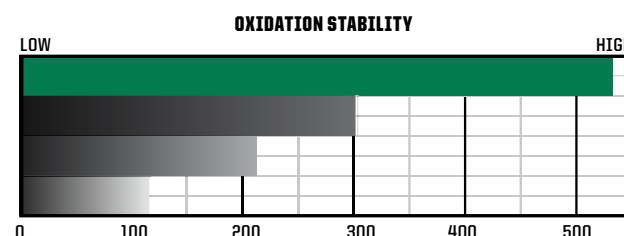

Higher Number = Longer Oil Life
Polaris proprietary additive system resists the negative effects of oil oxidation longer than leading aftermarket and automotive engine oils.

CLEAN ENGINE, LOWER DEPOSITS

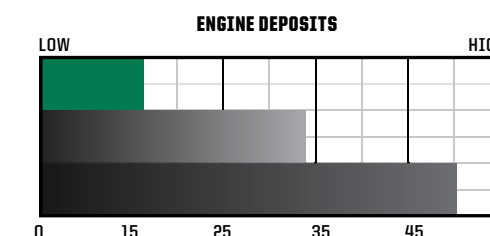

Clean Engine Test
Lower Number = Less Deposits, Cleaner Engine Operates at Peak Performance.
ASTM Test D6335

OIL DEVELOPMENT

POLARIS INVESTS IN EACH OIL AT AND ABOVE THESE LEVELS.

POLARIS.COM/ShopRANGER

12 DEDICATED TEAM MEMBERS

FOCUSED ON POLARIS OIL

18+ MONTHS

DEVELOPMENT & TESTING

75,000+ HOURS

DYNO TESTING

64,374 KILOMETERS

FIELD TESTING (1.8 MILLION MILES)

PARTS & GARAGE

OIL & LUBRICANTS

OIL & LUBRICANTS

HO PARTS

SERVICE PARTS

BATTERY & LIFTS

VEHICLE CARE & TRAILERING

MAINTENANCE FLUIDS



ENGINE OIL

Maximum protection for your 4-cycle engine.

Change every 100 hours, 6 months or 500 miles / 800 km.



AGL

Protect gears, drive chain, and bearings from scoring and wear.

Change every 100 hours, 12 months or 1000 miles / 1600 km.

- » 1 QT. • 2878068
- » 1 GAL. • 2878069
- » 2.5 GAL. • 2878070
- » 55 GAL. • 2879594

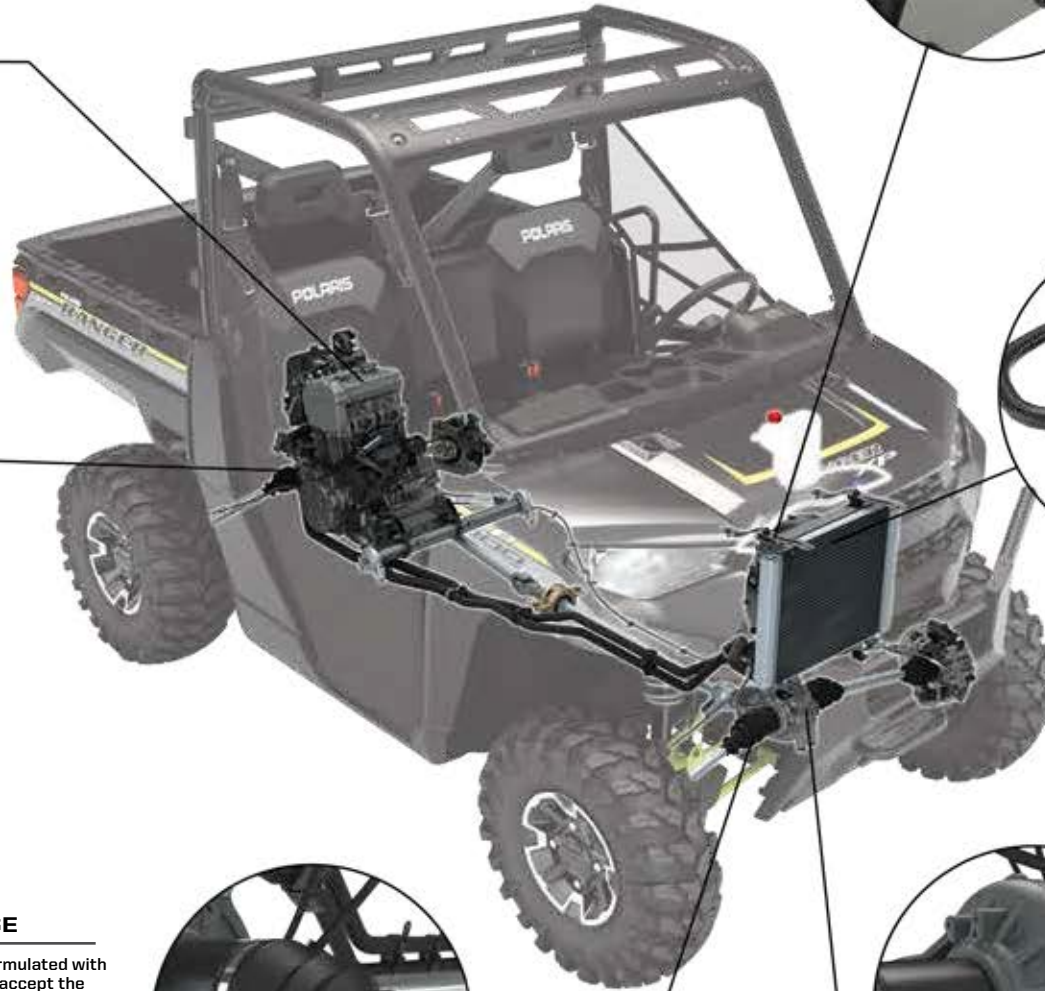

SUSPENSION/ U-JOINT GREASE

A heavy-duty lubricant formulated with molybdenum disulfide to accept the high shock applications of Polaris ATV shaft drive universal joints.

Add every 50 hours, 3 months or 500 miles / 800 km.

- » 3 OZ. • 2871515
- » 14 OZ. • 2871551



DOT 4 BRAKE FLUID

A high-quality brake fluid designed for use in Polaris hydraulic brakes.

Change every 200 hours, 2000 miles / 3200 km or every 2 years.

- » 12 OZ. • 2872189



ANTI-FREEZE

Prevent corrosion on metal components, eliminate scaling, and maximize cooling system performance.

Change every 60 months.

- » 1 QT. • 2880514
- » 1 GAL. • 2880513
- » 55 GAL. • 2880512



DEMAND DRIVE FLUID

Provide positive 4WD engagement in extreme cold or high head conditions and protect internal components under heavy loads.

Change every 100 hours, 12 months or 1000 miles / 1600 km.

- » 1 QT. • 2877922
- » 2.5 GAL. • 2877923



LUBRICANT ACCESSORIES



NEW OIL FILTER WRENCH

Remove Polaris ORV oil filters with ease.

- » 2830550 • \$10⁹⁹

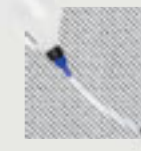

NEW FLUID FUNNEL

Easily add oil with high accuracy.

- » 2830552 • \$17⁹⁹



NEW FLUID TRAY

Holds up to 8 quarts of fluid.

- » 2830551 • \$26⁹⁹



NEW FLUID SYRINGE

Easily add and remove fluid from your vehicle.

- » 2830553 • \$39⁹⁹



GREASE GUN

Enables easy application of grease.

- » 2871312 • \$44⁹⁹

FITS 2871322 ALL-SEASON AND 2871515 U-JOINT 3 OZ.

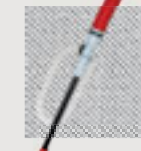

20 BATTERY-OPERATED SIPHON PUMP

Liquid transfer pumps 5-6 quarts/min suctioning power.

- » 2830513 • \$20⁷⁹

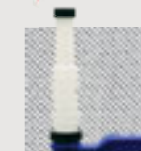

FLEX SPOUT

Fits all Polaris quart, gallon and 2.5 gallon bottles.

- » 2871285 • \$3⁹⁹

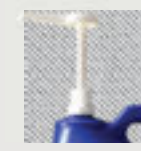

PUMP

Fits 1 and 2.5 gallon bottles.

- » 2870465 • \$9⁹⁹



PREMIUM GAS SHOCK OIL

Specialized shear stable blend containing high levels of anti-wear anti-foam & oxidation

- » 1 QT. • 2870995
 - » 2.5 GAL. • 2872279
- FOX® REBUILDABLE SHOCKS



10WT GAS SHOCK OIL

Specialized fluid to ensure proper gas shock absorber action

- » 1 QT. • 2874124

WALKER EVANS® REBUILDABLE SHOCKS



CHAIN LUBRICANT

Provides superior anti-wear and shock protection

- » 16 OZ. AEROSOL 2872348



ALL-SEASON GREASE TUBE

Specialized water resistant lubricant

- » 3 OZ. • 2871322
- » 14 OZ. • 2871423



ANGLE DRIVE FLUID

Extreme pressure, anti-wear and high viscosity film lubrication for maximum protection

- » 1 QT. • 2876160
- » 2.5 GAL. • 2872276

SPORTSMAN, RANGER, RZR ANGLE DRIVE GEAR CASE SYSTEMS



GENERATOR OIL

4-Cycle Engine Oil

- » 1 QT. • 2879383



CARBON CLEAN

Ultimate fuel and injection system cleaner

- » 12 OZ. • 2881413



ADVANCED FUEL TREATMENT

Dual Antioxidant formula protects jets and fuel system from gum and varnish

- » 12 OZ. • 2881416
- » 2.5 GAL. • 2881417

SERVICE PARTS

Polaris Engineered service parts deliver unmatched performance and fit for your off-road vehicle.

All service parts are engineered specifically for your machine. Which means everything is designed, tested and perfected to maximize the life of your ride. Getting Polaris Engineered parts is a decision that pays off in the long run, because it ensures there is a long run.



SHOP FOR SERVICE PARTS ONLINE OR VISIT YOUR POLARIS DEALER.

OVER
100,000
PARTS
AVAILABLE!



CHECK OUT OUR PARTS FINDER ON POLARIS.COM FOR EASY PARTS LOOK-UP, PARTS IDENTIFICATION, VIEWS OF ASSEMBLIES & MORE!



STEP 1

Visit Polaris.com/RANGER
Click "Parts & Service" tab
Click "Service Parts"



STEP 2

Enter **vehicle year/model** or shop by **part number**



STEP 3

Clearly see what parts are required and **order**

Assembly
DRIVE TRAIN, FRONT HALF SHAFT - R17RTVMSMAMBM (P01543)

R17RTV_39 RGR 1500 XP ALL OPTIONS (2017) (P03)

Zoom In Zoom Out

Qty	Part #	Description	Price	Qty	Add
2	1530565	ASM-HALF SHAFT FRONT (INCL ALL)	\$240.99	2	Add
1	3236775	ASM-OUTER JOINT	\$104.99	1	Add
1	3236776	K-BOOT OUTER	\$45.49	1	Add
1	3236804	BOOT KIT (SP ONLY)	\$29.99	1	Add
1	3236905	INNER JOINT (SP ONLY)	\$114.99	1	Add
1	3236806	DRCLIP (SP ONLY)	\$5.29	1	Add
1	3236807	DRCLIP (SP ONLY)	\$5.29	1	Add
1	3237806	SHAFT DRIVE SERVICE	\$54.99	1	Add

HD HEAVY DUTY PARTS



All Polaris parts are developed and tested to help you get the most out of your ride. Now, we're taking the passion of our riders, workers, and outdoor enthusiasts to the next level with HD Parts.

Engineered & designed for:

- Greater durability
- Enhanced performance
- Greater wear & tear capabilities
- All weather conditions

NEW WHEELS & TIRES

Class leading durability for off-road performance and traction for confident driving in extreme conditions.

- » 1524022-458 • HD WHEEL - 14x7 (SHOWN)
- » 5417507 • PRO ARMOR HD-K - 29x10R14 (SHOWN)
- » 5457498-458 • HD WHEEL CENTER CAP (SHOWN)
- » 5415756 • PRO ARMOR XD-K FRONT
- » 5415757 • PRO ARMOR XD-K REAR



NEW WHEEL BEARINGS

Fully sealed for added protection against intrusions. Made of a higher grade steel for extended life in extreme conditions.

LOCATION	OE	HD HEAVY DUTY PARTS
FRONT WHEEL BEARINGS	3514924	3515090
	3514634	3515088
REAR WHEEL BEARINGS	3514924	3515090
	3514917	3515087
	3514635	3515087



NEW BUSHINGS

The advanced material compound of the bushings enables tighter tolerances to reduce overall wear on the system, while the superior triple lip sealing prevents intrusion of the elements.

LOCATION	OE	HD HEAVY DUTY PARTS
FRONT UPPER BUSHINGS	5439874	1543367
	5439730	1543326
	5439270	1543326
FRONT LOWER BUSHINGS	5439874	1543367
	5439730	1543326
	5439270	1543326
REAR UPPER BUSHINGS	5439874	1543367
	5439730	1543326
	5439270	1543326
REAR LOWER BUSHINGS	5439874	1543367
	5439730	1543326
	5439270	1543326
UPPER HUB BUSHINGS	5439270	1543326
LOWER HUB BUSHINGS	5439270	1543326



COMING SOON BRAKES

Engineered to provide longer life and better stopping power while riding in extreme conditions.



NEW BUSHING KITS

Easily update the entire front and rear suspension.

- » 2830560
XP 900 '13-'19, XP 900 CREW '14-'19, XP 1000 '17, XP 1000 CREW '17, 570 FULL SIZE '15-'20, 570 FULL SIZE CREW '15-'20
- » 2830561 (SHOWN)
570 EFI '14-'20, 570 EFI CREW '14-'20

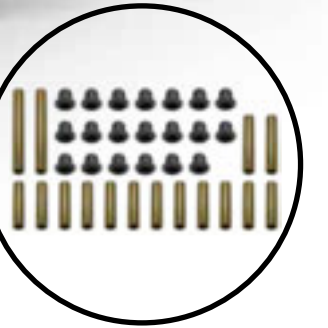

For more information regarding Polaris HD parts including vehicle compatibility, installation, and maintenance, please contact your authorized Polaris ORV dealer.

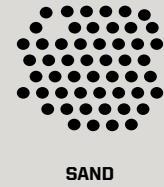

SAND



MUD



WATER



EXTREME COLD



EXTREME HEAT UP TO 130° F



HEAVY PAYLOADS



EXTENDED LIFE

PARTS & GARAGE

OIL & LUBRICANTS

MAINTENANCE

HD PARTS

SERVICE PARTS

HD PARTS

VEHICLE CARE & TRAILERING

*Claims made based off testing and performance of Polaris HD Parts against standard OEM parts made by Polaris and competitor brands under normal use.

VISIT [POLARIS.COM/HDPARTS](https://www.polaris.com/hdparts) TO LEARN MORE

BatteryMINDER®

ENSURE YOUR RIDE IS READY WHEN YOU ARE.

- Add years of capacity, power and range to new and older batteries, regardless of type or brand
- Never over- or under-charged in any temperature
- Leave your vehicle connected for months and return to fully charged and conditioned batteries
- Recover older or weak batteries that would normally need to be replaced

- Charge and maintain extra backup batteries as well as those in your vehicle
- Automatic turn-on, sleeps while keeping your batteries at full charge
- Easy push-button selector to change battery type or time



	2012 AGM 2-AMP	2012 LEAD ACID 2 AMP	1510 1.5 AMP	1.5 AMP CONVERTIBLE
PART NUMBER PRICE	2830438 \$121 ⁹⁹	2830531 \$109 ⁹⁹	2830404 \$79 ²⁹	2830511 \$91 ⁴⁹
VOLTAGE WARRANTY	12 V 5 Years	12 V 5 Years	12 V 10 Years	12 V 5 Years
CHARGING CURRENT	2AMP	2AMP	1.5AMP	1.5AMP
OVERCHARGE PROTECTION	Yes			
BATTERIES MAINTAINED	6 at one time		4 at one time	
BATTERY COMPATIBILITY	12 V Sealed AGM Lead-Acid	12 V Flooded (filler cap) and Sealed Maintenance-Free Batteries		
COMES WITH	• Non-fused battery clip cord set with Quick Connector	• BC-2410: 2' Non-fused battery clip cord set with Quick Connector • RTA-2415: 2' Fused ring terminal cord set with Quick Connector • ATS-1: Ambient Temperature Sensor	• Ambient temperature sensor (installed) • 12' power cord • Battery clip cord set with Quick Connector	• Auto-temp compensation sensor (installed) • Optional permanent mounting brackets & screws • Battery clips (fully-insulated, aircraft grade, 15A replaceable fuse) • Ring terminal assembly with 15A replaceable fuse
KEY FEATURES	Designed for high-performance specialty AGM sealed batteries	Diagnoses battery's condition - can predict failing batteries	Easy to use, economical	Convertible on-vehicle or bench top use

BATTERY MAINTENANCE TIPS

Extend your battery life with a BatteryMINDER® and these tips.

1. Store batteries in a cool, dry location.
2. Check that the battery connections are tight. Cables should not be able to be rotated or shifted by hand.
3. If your battery has a drain tube, make sure it is free of clogs.
4. Clean your battery - use a soft brush to scrub the top of the battery. Use baking soda to remove grease.
5. Connect a BatteryMINDER® after using your vehicle even if the vehicle is in regular use.

TIRE SEALANT

HOW IT WORKS

Tire sealant remains liquefied inside your tire until a leak develops in the tire or wheel.



Once a leak occurs, the tire sealant rushes out of the tire and quickly creates a permanent solid plug.

The plug maintains the pressure of the tire so you can continue your ride.



HOW MUCH TIRE SEALANT DO YOU NEED?

$$\begin{array}{ccc} \text{TIRE HEIGHT (IN.)} & \times & \text{TIRE WIDTH (IN.)} \\ | & & | \\ \text{Ex: } 27'' & \times & 10'' \\ \hline & / & 5 \\ \hline & = & 54 \text{ oz.} \end{array}$$

FOR A FULL APPLICATION CHART, VISIT POLARIS.COM/TIRESEALANTCHART

PREMIUM TIRE SEALANT

- Instantly seals and repairs rim, bead leaks, and punctures up to 1/4" on standard tires, and 3/4" on heavy ply tires
- Helps maintain air pressure for the life of the tire
- Helps seal the tire bead against the wheel
- 100% water soluble for easy cleanup
- Will not rust, corrode, or pit wheels
- Creates permanent repair
- Remains fluid and effective in temperatures down to -45° F
- Easily installed through existing tire valve stem with valve core removed

- » 32 OZ. • 2830484 • \$25⁹⁹
- » 1 GALLON • 2830485 • \$89⁹⁹
- » 5 GALLON • 2830486 • \$364⁹⁹
- » 5 GALLON PUMP • 2830487 • \$163⁴⁹
- » 55 GALLON • 2830489
- » 275 GALLON • 2830488

24 X 7 COVERAGE | BE PREPARED FOR ANYTHING

BatteryMINDER® ACCESSORIES



BatteryMINDER® 12' CABLE

- Made with heavy-duty 16 gauge black zip cord featuring automotive SAE bullet connectors

» 2830410 • \$15⁹⁹



BatteryMINDER® VPP-12:12/24 VOLT VEHICLE POWER PLUG

- Allows easy connection to vehicle's battery through lighter or 12/24V power port with replaceable 15 amp fuse

» 2830518 • \$12⁹⁹



BatteryMINDER® SPLITTER

- Connect two batteries simultaneously for easy battery maintenance
- Cap includes a set of ring terminals

» 2830409 • \$30⁴⁹



BatteryMINDER® RING TERMINAL

- Features 24-inch long 18-gauge wire
- Plug has standard 5/16" negative and 3/8" positive terminals
- Replaceable 15 amp in-line fuse for circuit protection

» 2830437 • \$12⁹⁹



BatteryMINDER® EZ CONNECT

- Allows for quick and easy connecting and disconnecting of your BatteryMINDER®
- Includes a set of ring terminals

» 2830411 • \$42⁹⁹

SHOP ACCESSORIES



POLARIS X3 CREEPER

- Three positions: flat, 45-degree angle or seated work stool
- Helps you perform any repair with ease
- Stay dry and warm away from cold, wet cement floors
- Easily stores away when not in use

» BLACK • 2830429 • \$182⁹⁹



POLARIS MAGNETIC PARTS TRAY

» SILVER • 2830432 • \$18⁹⁹



POLARIS 33" TELESCOPIC MAGNET

» BLACK • 2830435 • \$6⁹⁹



POLARIS 12" HI-TORQUE RATCHETING DRIVER

» BLACK / BLUE • 2830434 • \$24⁹⁹



POLARIS LED POCKET FLASHLIGHT

» BLACK • 2830436 • \$30⁹⁹

CV BOOT REPAIR KIT

FIX ON THE GO | TEMPORARY COVERAGE

- A quick trail side fix to increase trail time
- The flexible and durable boot material expands over a cone tool for CV boot repairs, without disassembling CV axles
- Universal fit - works as a temporary fix for most powersports axles
- All components fit inside the cone, and a cover is provided for compact durable storage
- Easily fits in a cargo box, attached to the roll cage, in the glovebox, or many other storage locations



Items shown are contained inside cone

UTV CV BOOT REPAIR KIT

- Kit includes the following items:
- (1) Expandable XL CV Boot
- (1) Reusable Cone Tool
- (2) CV Boot Clamps
- (1) Tube of Silicone Lube
- (1) Grease Packet
- (1) Cone Cover

» 2830526 • \$36⁹⁹

UTV TRAIL BOOT ONLY

» 2830527 • \$18⁹⁹

ATV

» CV REPAIR KIT 2830528 • \$31⁷⁹

» TRAIL BOOT ONLY 2830529 • \$18⁹⁹

SEE HOW THE CV BOOT REPAIR KIT WORKS AT POLARIS.COM/MAINTENANCE-VIDEOS

HOW TO INSTALL

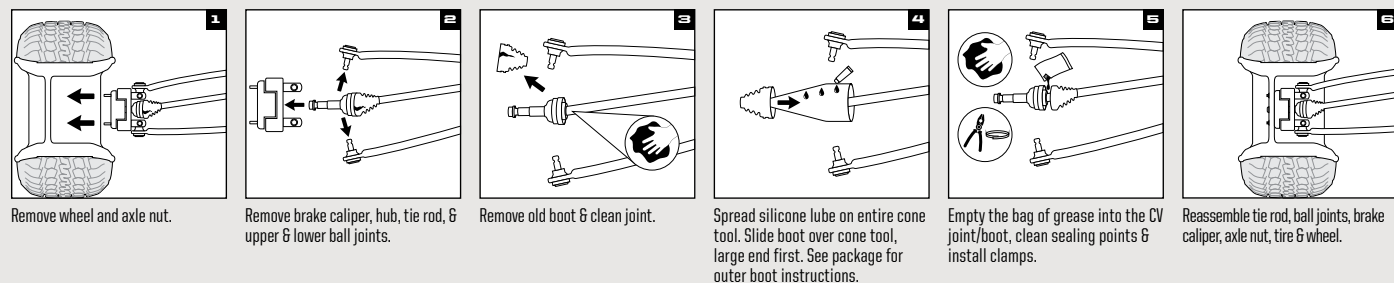

Refer to your service manual for further instructions and torque specifications.
*Designed for temporary CV boot repair. Purchase the OEM CV Boot for a permanent repair.

KEEP IT CLEAN

VEHICLE SHINE

MUD SHIELD PRE-TREATMENT



- Inhibits the adhesion of dirt, mud, and snow, making cleaning your vehicle faster and easier.

» 16 OZ. AEROSOL • 2830229 • \$14⁹⁹

POLARIS POLISH



- Easy protection and shine—spray on, wipe off, and go. For ideal use on painted and plastic surfaces. Contains carnauba wax.

» 12 OZ. • 2830228 • \$12⁹⁹

VEHICLE & EQUIPMENT WASH



- Concentrated professional grade formula powers through vehicle buildup, dirt and grease with a spot-free rinse. Treat up to 32 gals. Biodegradable product.

» 1 GAL. • 2830417 • \$19⁹⁹
» 5 GAL. • 2830422 • \$69⁹⁹

SHOP

POLARIS SHOP TOWELS



» 200 CT WITH DISPENSER (SHOWN) 2830402 • \$28⁹⁹
» 200 CT REFILL • 2830403 • \$19⁹⁹
» 64 CT REFILL • 2830440 • \$6⁹⁹

POLARIS HEAVY-DUTY SCRUBBER WIPES



» 90 CT • 2830441 • \$24⁹⁹

ALL-PURPOSE CLEANER PLUS



- Professional-grade formula removes built-up stains from shop floors, work benches, and other hard surfaces. VOC-free, environmentally-friendly, and biodegradable.

» 1 GAL. • 2830414 • \$19⁹⁹
» 5 GAL. • 2830416 • \$69⁹⁹

HD CLEANER & DEGREASER



- Professional-grade, biodegradable, high-foaming formula dissolves and removes tough stains and soils.

» 1 GAL. • 2830418 • \$23⁹⁹
» 5 GAL. • 2830420 • \$95⁹⁹

BRING IT EVERYWHERE

TRAILERING



CALIBER[®] RAMP PRO

- Designed for ATVs and UTVs up to 50" wide
 - Integrated grip glides for ultimate traction
 - Folding sides for easy transportation & storing
- » 52" x 90" • 2884576 • \$519⁹⁹



ALUMINUM ARCHED LOADING RAMPS

» 76" x 12" • 2,000 lb • 2875384 • \$279⁹⁹
» 88" x 12" • 3,000 lb • 2875386 • \$459⁹⁹



LIGHTWEIGHT TRI-FOLD RAMPS

- Ramp folds up for transport
 - Capacity for up to 1,500 lb
 - Safety straps included
- » 72" x 51" • 2875385 • \$309⁹⁹
» 82" x 51" • 2875860 • \$369⁹⁹



FOLDING ALUMINUM ARCHED RAMPS

- Ramp folds up for transport
 - Up to 1,500 lb total capacity, 750 lb per individual ramp
 - Safety straps included
- » 88" x 12" • 2875387 • \$379⁹⁹

HITCHES

3:1 HITCHES VERSATILE 3 IN 1 FUNCTIONALITY

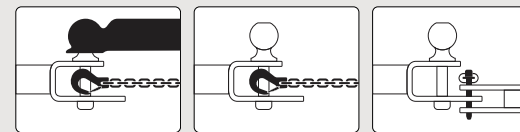

- Ball, pin and hook design
- Durable, rust resistant steel with black powdercoated finish

- Removable ball
- HD 5/8" pin and clip



HITCH WITH 2" BALL

» 2" x 2" RECEIVER 2830522 • \$48⁷⁹
» 1 1/4" x 1 1/4" RECEIVER 2830523 • \$48⁷⁹



1 7/8" BALL

- 1 7/8" replacement ball for hitch
- Designed to work with 3:1 Hitch

» 2830524 • \$12⁹⁹



2" HITCH BALL MOUNT

» 2" RECEIVER TONGUE 2875320 • \$59⁹⁹
» FRONT HITCH RECEIVER 2878846 • \$169⁹⁹



TRAILER BALL 3/4" SHANK

» 2" BALL • 2877603 • \$18⁹⁹
» 1 7/8" BALL • 2877602 • \$18⁹⁹

STRAPS & ROPES



2" x 30' RECOVERY STRAP

- 18,000 lb Breaking Strength / 9,000 lb Max. Vehicle Weight
 - Built in strap wrap - easy storage
 - Loops sewn in to webbing
 - 1 Strap bag
- » 2884033 • \$74⁹⁹



1.5" x 15' 5,500 LB RATCHET STRAP

- Heavy duty webbing
 - 5,500 lb Maximum Load / 1,833 lb Working Load
 - 2 Pack
- » 2884031 • \$59⁹⁹



2" x 20' 10,000 LB RATCHET STRAP

- Heavy duty webbing
 - 10,000 lb Maximum Load / 3,300 lb Working Load
 - Floating D-Rings
 - Double J-Hooks
- » 2884032 • \$43⁹⁹



SHOCK STRAPS

- 1.5" 3,000 lb breaking strength
 - Keeps tension on tie-down straps to secure load
 - 2 Pack
- » 2883296 • 1.5" x 15' • \$109⁹⁹
» 2883295 • 1.5" x 7' • \$94⁹⁹

COVERS

2-SEAT & CREW TRAILERING COVERS

» 2880632 • 570/500/EV • \$409⁹⁹
EV LION '16-18, EV '15-20, 570 '15-20, 500 '17-20
» 2880633 • 570 CREW • \$539⁹⁹
CREW 570-4 '15-20



3-SEAT & CREW TRAILERING COVERS

» 2883419 • XP 1000 • \$409⁹⁹
XP 1000 '17-21, 1000 '20-21
» 2883840 • CREW XP 1000/900/DIESEL • \$409⁹⁹
XP 1000 '18, CREW XP 1000 '17-21, CREW 1000 '20-21
» 2882160 • POLARIS PURSUIT CAMO SxS FIELD COVER • \$169⁹⁹
XP 1000 '14-21, EV '11-21, 570 FULL-SIZE '17-21, 570 '14-21, 500 '11-21, 1000 '20-21



NEW P2000i Inverter Generator	2830532	\$899 99	1600 Running Watts	2000 Starting Watts	16.7 Max Amps at 120V	7.6 Run Time at 25% Load w/ Smart Throttle (hrs)	62 Noise Level at 25% Load (dBA)
---	---------	-----------------	------------------------------	-------------------------------	---------------------------------	--	--

FEATURES

- Extension Cord Management
- Multi Functional Digital Display
- Illuminated Control Panel
- Multi Handle Design
- Parallel Capable

BEST USED FOR

- Tailgating
- Off-Grid
- Camping



ACCESSORIES	2830536 INVERTER PARALLEL KIT 2830540 ALL WEATHER COVER	2884865 HIGH ALTITUDE MODIFICATION KIT 2879383 GENERATOR OIL
--------------------	--	---

NEW P3200iE Inverter Generator	2830533	\$1899 99	2800 Running Watts	3200 Starting Watts	23.3 Max Amps at 120V	10.1 Run Time at 25% Load w/ Smart Throttle (hrs)	67 Noise Level at 25% Load (dBA)
--	---------	------------------	------------------------------	-------------------------------	---------------------------------	---	--

FEATURES

- Key Fob Remote Start
- Multi Functional Digital Display
- Fuel Gauge
- Extension Cord Management
- Parallel Capable

BEST USED FOR

- DIY Remodeling
- One Room Backup
- Camping



ACCESSORIES	2830536 INVERTER PARALLEL KIT 2830541 ALL WEATHER COVER	2884866 HIGH ALTITUDE MODIFICATION KIT 2879383 GENERATOR OIL
--------------------	--	---



NEW P5500 Open Frame Generator	2830534	\$1799 99	5000 Running Watts	5500 Starting Watts	20/30 Max Amps at 120/240V	5 Run Time (hrs)	75 Noise Level (dBA)
--	---------	------------------	------------------------------	-------------------------------	--------------------------------------	----------------------------	--------------------------------

FEATURES



Extension Cord Management



Fuel Gauge



Electric Start



Rough Terrain Wheel

BEST USED FOR

-  Construction
-  Home Backup
-  RV-ing



ACCESSORIES 2830542 ALL WEATHER COVER
 2884867 HIGH ALTITUDE MODIFICATION KIT

2879383 GENERATOR OIL

NEW P6500 Open Frame Generator	2830535	\$1999 99	6000 Running Watts	6500 Starting Watts	20/30 Max Amps at 120/240V	5 Run Time (hrs)	75 Noise Level (dBA)
--	---------	------------------	------------------------------	-------------------------------	--------------------------------------	----------------------------	--------------------------------

FEATURES



Extension Cord Management



Fuel Gauge



Electric Start



Rough Terrain Wheel

BEST USED FOR

-  Construction
-  Home Backup
-  RV-ing



ACCESSORIES 2830542 ALL WEATHER COVER
 2884867 HIGH ALTITUDE MODIFICATION KIT

2879383 GENERATOR OIL

VISIT POLARISPOWER.COM
FOR ALL PRODUCT FEATURES

RIDING GEAR



OFF-ROAD RIDING JERSEYS

S-3XL | \$45.99

- Mesh ventilated panels for maximum airflow
- Elastic sleeves with non-restrictive cuffs

OFF-ROAD RIDING GLOVES

S-3XL | \$32.99

- Adjustable wrist closure for a custom fit
- Silicon finger grips and neoprene knuckle protection

YOUTH JERSEY

S-XL | \$34.99

MULTICOLOR | 2860652
BLUE | 2860651



BLACK
JERSEY | 2860646
GLOVE | 2860641

BLUE/LIME
JERSEY | 2860647
GLOVE | 2860642

MULTICOLOR
JERSEY | 2860648
GLOVE | 2860643

NAVY/PINK
JERSEY | 2860649
GLOVE | 2860644

RED
JERSEY | 2860650
GLOVE | 2860645

TEKVEST® ULTIMATE PROTECTION



TEKVEST® SUPERSOFT

S-3XL | 2862190 | \$529.99

- Zip-off fleece collar diffuses rising body heat to reduce fogging
- Drop-tail design for extended coverage
- 2-stage pockets



TEKVEST® FREESTYLE

S-3XL | 2862189 | \$429.99

- Strong, protective ultra high molecular weight panels cover shoulders
- Front and rear mesh panels promote cooling airflow



TEKVEST® YOUTH

70-100 lbs | 2862191 | \$353.99

- Adjustable side straps and arm straps
- Strong, protective ultra high molecular weight panels cover shoulders

COOLING SHIRTS

MEN'S LONG SLEEVE COOLING SHIRT

S-3XL | 2860638 | \$58.99

WOMEN'S LONG SLEEVE COOLING SHIRT

S-3XL | 2860640 | \$58.99



FABRIC TECHNOLOGY DESIGNED TO KEEP YOU COOL

Cooling fabric designed with sun protection in mind. Our chemical-free fabric Coolcore® reduces the surface temperature on our cooling shirt up to 30%, so you don't overheat. It carries a 50 Ultraviolet Protection Factor rating, the highest attainable, blocking 98% of harmful UV rays.

SHORT SLEEVE COOLING SHIRTS

MEN'S
S-3XL | 2860634 | \$45.99

WOMEN'S
S-3XL | 2860636 | \$45.99

HEATED VEST



HEATED VESTS

S-3XL | \$266.99

NEW WOMEN'S BLACK | 2861440

NEW MEN'S BLACK | 2861441

- Replacement / Spare Battery: 2869692
- Replacement Cord: 2869694

RAIN SUIT



RAIN JACKET GRAY

S-3XL | 2869527 | \$129.99

RAIN PANTS GRAY

S-3XL | 2869528 | \$109.99

- 100% waterproof lightweight and packable nylon
- YKK® Zippers
- Rain jacket has removable hood



RED/BLACK
XS-4XL
2861470



[ALTITUDE]



BLACK
XS-4XL
2861469



BLACK/RED
XS-4XL
2861472



\$532⁹⁹
CARBON FIBER
BLACK/LIME
XS-4XL | 2861473

NEW
509[®] ALTITUDE 2.0 HELMET

\$399⁹⁹

Lightweight Design, performance-infused style and features with all-day comfort

SHELL

- Strong, lightweight construction of carbon fiber or fiber glass

WEIGHT

- Composite as low as 1,260g
- Carbon fiber as low as 1,150g

FEATURES

- Superior fit for all-day comfort
- Removable Pro Series breath box provides excellent ventilation and air flow
- One-piece eye-port creates draft-free seal with 509[®] goggles
- Magnetic Fidlock[®] chin-strap technology and integrated GoPro[®] mount
- DOT- and ECE 22.05-approved



[TENACITY]



BLACK
XS-2XL
2861557



BLACK/GRAY
XS-2XL
2861558



BLACK/WHITE
XS-2XL
2861560



WHITE/RED
XS-2XL
2861561



PINK
XS-2XL
2861562

NEW
TENACITY 4.0 HELMET

\$186⁹⁹

Combination of modern style and premium protection with incredible value

SHELL

- Shock-resistant, injection-molded thermoplastic

WEIGHT

- 1,500g

FEATURES

- Through-flow, full-helmet ventilation
- ProClip quick release chin strap allows you to fasten the chin strap in seconds
- Removable breath box
- Tool-less adjustable roost shield
- Removable, washable liner
- DOT- and ECE 22.05-approved

GOGGLES



BLACK
2868669



RED
2868670



LIME
2868671



BLUE
2868667

KINGPIN 509[®] DIRT GOGGLE

\$74⁹⁹

Premium Materials, attractive price

FEATURES

- Oversized spherical lens delivers optimal peripheral vision
- Metal tear off posts provide strength and durability
- Quick-change technology allows you to run the best lens tint for conditions



ORANGE
2868668

TRAIL GOGGLE

\$46⁹⁹

Clear Vision at a Great Value

FEATURES

- Offers a distortion-free view with anti-scratch, anti-fog and UV-blocking technology
- Large lens opening enables greater peripheral vision



BLACK
2867917

OUTERWEAR

FORCE JACKET

WINDBREAKER JACKET

NEW
FORCE JACKET \$186⁹⁹

Versatile, lightweight jacket ideal for layering or wearing as a casual jacket.

MEN'S | S-3XL | 2861432



WOMEN'S
S-3XL | 2861433

NEW
WINDBREAKER JACKET \$132⁹⁹

Lightweight, windproof jacket that provides protection while riding.

- 100% polyester windproof fabric
- 3 external pockets allow for maximum storage

S-3XL | 2861541

GRAY/BLUE
S-3XL | 2861439

BLACK
S-3XL | 2861434

NEW
SOFTSHELL JACKET \$172⁹⁹

Lightweight performance that's surprisingly warm and perfect for everyday wear

- DWR prevents precipitation from saturating the jacket's exterior
- Three external and one internal pocket
- Lined with 280 grams of soft fleece for warmth
- Removable hood and underarm venting



MAROON
S-3XL | 2861438

BLACK
S-3XL | 2861437

GRAY
S-3XL | 2861435

BLACK/BLUE
S-3XL | 2861436

WOMEN'S

MEN'S

FLANNEL JACKET
BRONZE
S-3XL | 2860864

WORK JACKET
FOREST GREEN
S-3XL | 2860862

FLANNEL JACKET \$129⁹⁹

CHARCOAL
S-3XL | 2860865

This stylish flannel jacket is designed to keep you riding on brisk days. Soft yet durable brushed flannel with a Sherpa fleece lining offers excellent insulation without the bulkiness of a winter jacket.

WORK JACKET \$207⁹⁹

This warm and rugged jacket was engineered to be tough enough for work yet stylish enough for play.

External features:

- Constructed of Nylon 6, a durable, tear-resistant non-stretch woven fabric
- Coated with Durable Water Repellency (DWR) to provide water-resistance in the elements
- Four external pockets for maximum gear storage

Internal features:

- 80 gram 3M® Thinsulate® for added warmth
- Built in action back for increased range of motion
- Internal zipper pocket
- Brushed flannel trim

NEW
BLACK S-3XL | 2861608
GRAY S-3XL | 2860863

LAYERING

TECH QUARTER ZIP
PINK
S-3XL | 2861448

NORTHSTAR MID LAYER
BLACK/GRAY
S-3XL | 2869925

NEW
TECH QUARTER ZIP \$79⁹⁹

Excellent for ride layering, comfortable and stylish stand-alone.

WOMEN'S



BLACK
S-3XL | 2861447

MEN'S



BLUE
S-3XL | 2861443



BLACK
S-3XL | 2861442

NORTHSTAR MID LAYER \$119⁹⁹

Breathable fleece mid-layer is perfect for adding warmth or as a stand-alone shirt.



NEW
BLACK/RED
S-3XL | 2861445



NEW
MEN'S ICON HOODIE
 S-3XL | \$72.99
 BLACK | 2861496
 GREEN | 2861495



NEW
WOMEN'S TECH HOODIE
 S-3XL | \$86.99
 GRAY | 2861508
 MAROON | 2861509



POLARIS RANGER HAT
 \$29.99
 GRAY S/M | 2869604
 GRAY L/XL | 2869605

POLARIS RANGER TEE
 S-3XL | \$32.99
 GRAY | 2869580
 OLIVE | 2869581



NEW
BADGE TRUCKER HAT
 One-Size | \$32.99
 GRAY | 2861531
 NAVY | 2861532
 BLACK | 2861533
 PINK | 2861549
 MAROON | 2861537



NEW
TONAL HAT
 L/XL | \$32.99
 BLACK | 2861526
 NAVY | 2861525



NEW
CORE HAT
 One-Size | \$32.99
 NAVY | 2861523
 BLACK | 2861524



NEW
CHECKERED HAT
 One-Size | \$32.99
 NAVY | 2861520
 GRAY | 2861521
 BLACK | 2861522



NEW
MEN'S CREW SWEATSHIRT
 S-3XL | \$64.99
 GREEN | 2861498
 NAVY | 2861497



NEW
WOMEN'S ICON HOODIE
 S-3XL | \$72.99
 MAROON | 2861507
 BLACK/PINK | 2861506



NEW
WOMEN'S ALL-IN TEE
 S-3XL | \$32.99
 BLACK | 2861598
 OLIVE | 2861599



NEW
MEN'S PERFORMANCE LONG SLEEVE
 S-3XL | \$52.99
 ROYAL | 2861589
 GRAY | 2861588



NEW
MEN'S TECH HOODIE
 S-3XL | \$86.99
 BLACK/BLUE | 2861494
 GRAY | 2861493



NEW
WOMEN'S CHECKERED HOODIE
 S-3XL | \$52.99
 BLACK | 2861609
 BLUE | 2861610



NEW
MEN'S BACK GRAPHIC TEE
 S-3XL | \$32.99
 GRAY | 2861568
 NAVY | 2861569



NEW
MEN'S STAMP TEE
 S-3XL | \$32.99
 GRAY | 2861565
 GREEN | 2861564

CAMO

NEW

STEALTH CAMO HAT
One-Size | \$32.99
CAMO | 2861527



NEW

NORTHSTAR MID LAYER
S-3XL | \$119.99
CAMO | 2861542

NEW

CAMO SOFTSHELL JACKET
S-3XL | \$172.99
CAMO | 2861543



CAMO POLY HOODIE
S-3XL | \$71.99
BLACK | 2860718



HUNTER CAMO HOODIE
S-3XL | \$67.99
OLIVE | 2868716
GRAY | 2860728



CAMO FULL ZIP
S-3XL | \$79.99
OLIVE | 2869590



MEN'S CAMO TEE
S-3XL | \$32.99
GRAY | 2860709
BLACK | 2860710



CAMO HOODIE
S-3XL | \$74.99
WOMEN'S | 2867898
MEN'S | 2867879



CAMO TRUCKER HAT
One-Size | \$32.99
BLACK | 2860613
PINK | 2860614

GIFTS & BRANDED MERCHANDISE

POLARIS STEEL SIGN (14" x 36")
2860868 | \$168.99

PINT GLASS (SET OF 2)
2860815 | \$25.99

POLARIS WOODEN COASTERS WITH BOTTLE OPENER
2860869 | \$32.99

DRINKWARE



PREMIUM COOZIE
2860829 | \$10.99



NEW
17oz WATER BOTTLE
2861611 | \$32.99



NEW
12oz CAMPER MUG
2861612 | \$39.99



NEW
15oz CAMPFIRE MUG
2861613 | \$26.99

RECREATION/GARAGE



NEW
EVENT FOLDING CHAIR
2861617 | \$59.99



NEW
FOLDING TABLE
2861620 | \$66.99



POLARIS WOOD SIGN (10.5" x 24")
2860866 | \$97.99



NEW
NECK GAITERS
One-Size | \$16.99
CAMO | 2861948
BLACK | 2861953

COLLECTIBLES



NEW
KEYCHAIN
2861614 | \$8.99



NEW
LEATHER KEYCHAIN
2861616 | \$8.99



RANGER FLAG (3' x 5')
2869930 | \$32.99



MINI RANGER TOY
2860820 | \$17.99

APPAREL & HELMETS

OUTWEAR & PROTECTION

LIFESTYLE & CAPS

CAMO & GIFTS

HARDEST WORKING.

SMOOTHEST RIDING.



CONNECT ONLINE
SEARCH "PolarisORV"



DOMINATE ANY ENVIRONMENT

1 CHOOSE
MODEL

2 CHOOSE
TRIM

3 CHOOSE
COLOR

4 CHOOSE
ACCESSORIES



VISIT POLARIS.COM/RANGER

TO SEE ALL YOUR OPTIONS & ACCESSORIES
ON YOUR NEW MACHINE FROM EVERY ANGLE!

Warning: Polaris off-road vehicles can be hazardous to operate and are not intended for on-road use. Driver must be at least 16 years old with a valid driver's license to operate. All riders should always wear helmets, eye protection and protective clothing and footwear. Read, understand and follow your owner's manual. Ride within the limits of your own abilities and never engage in stunt or exhibition driving. Never ride under the influence of drugs or alcohol. All riders should take a safety training course. Call 800-342-3764 for additional information.

POLARIS

MY21 RANGER APP ACC CAN - 9948060

Unless noted, trademarks are the property of Polaris Industries Inc. 3M® and Thinsulate® are registered trademarks of 3M Company. 509® is a registered trademark of Teton Outfitters, LLC. Apple® and App Store® are registered trademarks of Apple Inc. BatteryMinder® is a registered trademark of VDC Electronics Inc. Bluetooth® is a registered trademark of Bluetooth Sig, Inc. Browning® is a registered trademark of BROWNING INTERNATIONAL S.A. Calliber® is a trademark of Calliber, Inc. Can-Am® and Defender™ are trademarks of Bombardier Recreational Products Inc. CAMSO® is a registered trademark of Artic Investments S.A. Carhartt® is a registered trademark of Carhartt, Inc. COOLCORE® is a registered trademark of COOLCORE LLC. Fidlock® is a registered trademark of Fidlock GmbH. FOX® is a registered trademark of Fox Factory Inc. Google Play® is a registered trademark of Google, Inc. High Lifter™ is a trademark of High Lifter Products, Inc. Homelink® is a registered trademark of Johnson Controls Technology Inc. Honda® and Pioneer® are registered trademarks of Honda Motor Company, Ltd. High Lifter® is a registered trademark of High Lifter Products, Inc. Kolpin® is a registered trademark of Polaris Industries Inc. Mathews® is a registered trademark of MCP IP. MB Quart® is a registered trademark of Maxxsonics USA Inc. Otter® is a registered trademark of Otter Outdoors, LLC. Rhino Grip® is a registered trademark of Polaris Industries, Inc. Rigid® is a trademark of JST Performance, LLC d/b/a Rigid Industries LLC. Tiger Drylac® is a registered trademark of Tiger Coatings GMBH & CO. KG. TEKVEST® is a registered trademark of 1181676 ONTARIO INC. Velcro® is a registered trademark of VELCRO BVDA. Yeti® is a registered trademark of Yeti Coolers, LLC. YKK® is a registered trademark of YKK Corporation. YouTube® is a registered trademark of Google, Inc. Prices, Fitment and Availability are subject to change at any moment. Copyright © 2021 Polaris Industries Ind. All rights reserved.

MAY 2021