

CANADA VERSION

POLARIS SPORTSMAN

2021

ACCESSORIES + APPAREL



FORGE YOUR OWN PATH



Sportsman is legendary, giving you the ability to ride harder, go further and do more than any other ATV. From the farm yards to the scenic trails, the Polaris Sportsman line-up is chosen by more ATV owners than any other in the industry.

2021 LINEUP

SEE THE FULL LINEUP AT [POLARIS.COM/SPORTSMAN](https://www.polaris.com/sportsman)

NEW FOR MODEL YEAR 2021

P. 02

ACCESSORY PACKAGES: P. 02

NEW GENERATION OF SPORTSMAN 450 AND 570: P. 04

450 / 570

P. 14

RECREATION & UTILITY



SPORTSMAN 450 H.O. (EPS)



SPORTSMAN 570 (EPS/EBS)



SPORTSMAN TOURING 570 (EPS/EBS)



SPORTSMAN 570 HUNTER EDITION

WORK



SPORTSMAN 570 6X6



SPORTSMAN 570 X2

850 / XP 1000 / XP 1000 S

P. 26

RECREATION & UTILITY



SPORTSMAN 850



SPORTSMAN XP 1000



SPORTSMAN XP 1000 S



SPORTSMAN TOURING 850 / XP 1000

HUNT



SPORTSMAN XP 1000 HUNTER EDITION

MUD



SPORTSMAN 850 / XP 1000 HIGH LIFTER EDITION

TOURING

SCRAMBLER 850 / XP 1000 S

P. 34

SPORT PERFORMANCE



SCRAMBLER 850



SCRAMBLER XP 1000 S

YOUTH

P. 36



OUTLAW 70



POLARIS ACE 150 EFI

CONTENTS

NEW FOR MODEL YEAR 2021 02

WINCHES 12

450 / 570 14

WINCHES, PROTECTION & RACKS	16
COMFORT, AUDIO & STORAGE	18
WINDSHIELDS	20
570 6X6, 570 TOURING & 570 X2	22

850 / XP 1000 / XP 1000 S 26

WINCHES, RACKS & PROTECTION	28
COMFORT, AUDIO & STORAGE	30
WINDSHIELDS	32

SCRAMBLER 850 / XP 1000 S 34

WINCHES, RACKS/STORAGE & PROTECTION	34
-------------------------------------	----

ACE 150 / OUTLAW 70 YOUTH 36

COMMON ACCESSORIES 38

WHEELS & TIRES	38
TRACKS	44
GLACIER® PLOW SYSTEMS	46
LIGHTING	48
HUNT	50
POLARIS NORTHSTAR COOLERS	52

PARTS & GARAGE 54

MAINTENANCE	54
OIL & LUBRICANTS	56
MAINTENANCE FLUIDS	58
SERVICE PARTS	60
HO PARTS	62
BATTERY & TIRE SEALANT	64
VEHICLE CARE & TRAILERING	66
POLARIS POWER	68

APPAREL & HELMETS 72

OUTERWEAR & PROTECTION	72
LIFESTYLE APPAREL & CAPS	78
CAMO & GIFTS	80



SHOP ALL SPORTSMAN ACCESSORIES AT [POLARIS.COM/ShopSPORTSMAN](https://www.polaris.com/ShopSPORTSMAN)

MODEL YEAR 2021

TAKE YOUR SPORTSMAN PACKAGES AND LIMITED EDITIONS TO THE NEXT LEVEL

GO FURTHER
WITH YOUR SPORTSMAN
FACTORY-INSTALLED PACKAGE
OR LIMITED EDITION

Take your Sportsman to the next level and continue to customize with these accessory add-ons.
Polaris.com/SportsmanPackages

SPORTSMAN 570 EPS TRAIL EDITION
+ POPULAR ADD-ONS



TRAIL PACKAGE & ULTIMATE TRAIL LIMITED EDITION

MOST POPULAR ADD-ONS

- Racks P. 17
- Storage P. 19
- Windshields P. 20
- Wheels & Tires P. 38

SPORTSMAN 570 EPS UTILITY EDITION
+ POPULAR ADD-ONS



UTILITY PACKAGE AND HD UTILITY LIMITED EDITION

MOST POPULAR ADD-ONS

- Storage P. 19
- Windshields P. 20
- Winches P. 12
- Wheels & Tires P. 38

SPORTSMAN 450 AND 570 REBORN

WIDE SELECTION OF ACCESSORIES TO CHOOSE FROM TO
CUSTOMIZE YOUR EXPERIENCE

TRUE ON DEMAND
ALL-WHEEL DRIVE

BOLDER STYLE,
BIGGER VALUE

INDUSTRY-LEADING ACCESSORIES
ENGINEERED TO DO MORE
FOR EVERY KIND OF JOB BIG OR SMALL

SUPERIOR INTEGRATION

ESSENTIAL ACCESSORIES RIGHT
FROM THE FACTORY TO MAKE WORK
EASIER TO GET MORE DONE.

PRO PRO HEAVY DUTY SERIES
WINCHES

GLACIER
PLOW SYSTEM

Winches P. 12
Plows P. 46



ULTIMATE PROTECTION

VEHICLE AND RIDER PROTECTION
AGAINST OBSTACLES ON THE TRAIL.

LOCK & RIDE

Protection P. 16
Windshields P. 20
Handguards P. 18



STORAGE VERSATILITY

VERSATILITY, ADDED STORAGE,
AND LIMITLESS CUSTOMIZATION
WITH EASY INSTALLATION.

LOCK & RIDE

Storage P. 19
Racks P. 17
Rack Extenders P. 17



DESIGNED



Designed by the same people who designed your vehicle.

TESTED

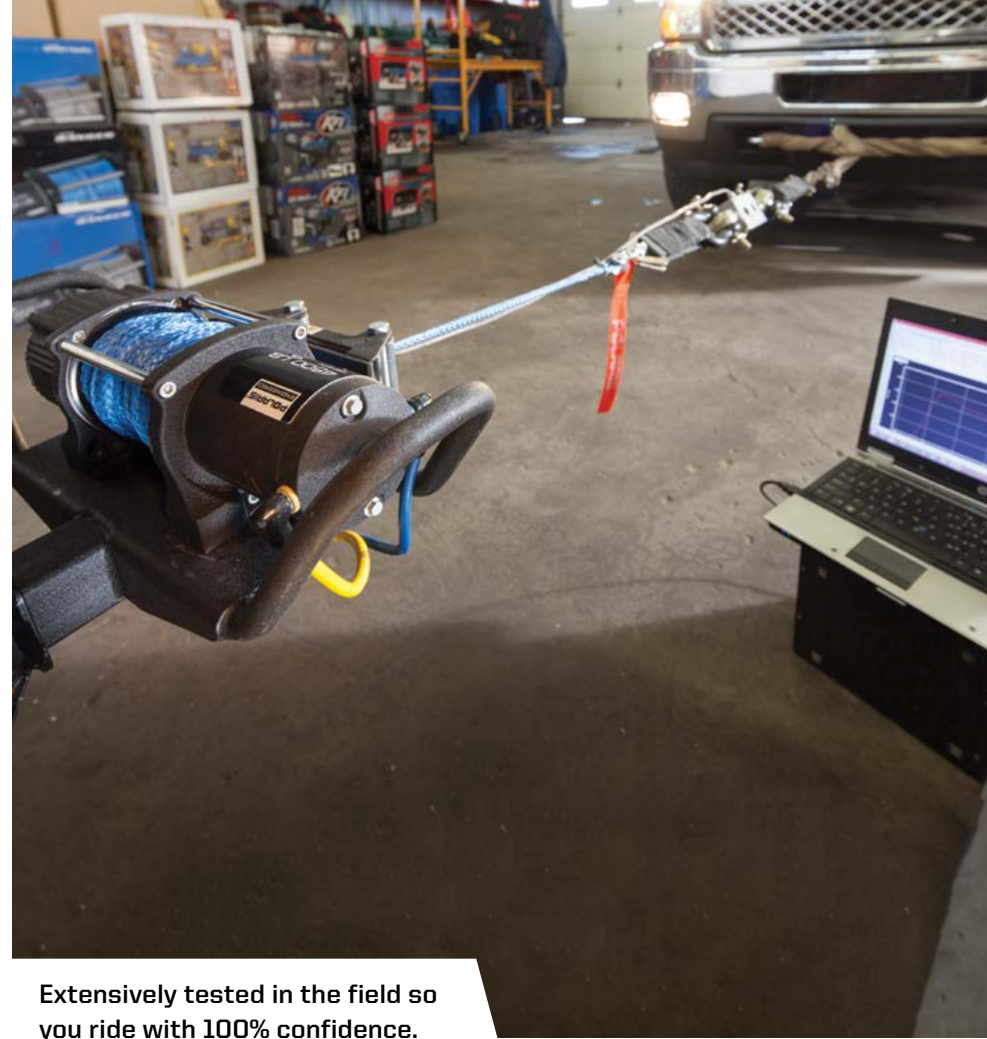

Extensively tested in the field so you ride with 100% confidence.

TRUSTED



**ACCESSORIES
BACKED BY A**



WARRANTY

65 years in the business.
The #1 name in Off-Road.

**WE HOLD OUR
PARTNERS TO THE
SAME STANDARDS**



**WHEELS, TIRES & LIGHTING DESIGNED WITH
POLARIS TO MAXIMIZE PERFORMANCE**

P. 38, 48



**A GLOBAL LEADER IN AUDIO INNOVATION,
DESIGN & ENGINEERING**

P. 19, 31



**PRODUCTS SO GOOD THEY REPLACE
OR REPAIR THEM FOR LIFE**

P. 48



**MAKING PRODUCTS FOR AVID
SPORTSMEN SINCE 1943**

P. 50

ENGINEERED

FOR MORE



Ensuring Polaris Engineered Accessories fit and work in sync with your machine is the most critical phase of testing and validation. With seamless integration, you can trust that any Polaris accessory you install will enhance your interaction beyond your expectations.



LOCK & RIDE

CARGO VERSATILITY

Lock & Ride mounting locations allow for limitless customization to let you work the way you want.

P. 19, 30

PRO PRO HEAVY DUTY SERIES

WINCHES

INTEGRATED WINCH MOUNT & PRE-WIRED

Designated mounting points and pre-wired connectors ensure a perfect fit and the strongest place to attach the Polaris Engineered winch - the most dependable winch for your Sportsman. With wiring built right into the vehicle, we made this the easiest Sportsman winch ever made to install.

P. 12

GLACIER[®] PLOW SYSTEM

INTEGRATED PLOW MOUNT

The attachment points for the best-in-class Glacier[®] Plow System are integrated right at the factory and feature an innovative drive-up and go installation process.

P. 46

SUPERIOR

INTEGRATION

POLARIS
ENGINEERED

Right from the factory, your vehicle is built to make essential accessories like winches and plows easy to use day-in and day-out. Mounting brackets are designed into the oversized factory bumper and wiring is routed securely and properly. When it comes to Sportsman, Polaris Engineered Accessories make work easier so you can get more done.

PRO PRO HEAVY DUTY SERIES



HID HEAVY DUTY SERIES



WINCHES

PLOWS

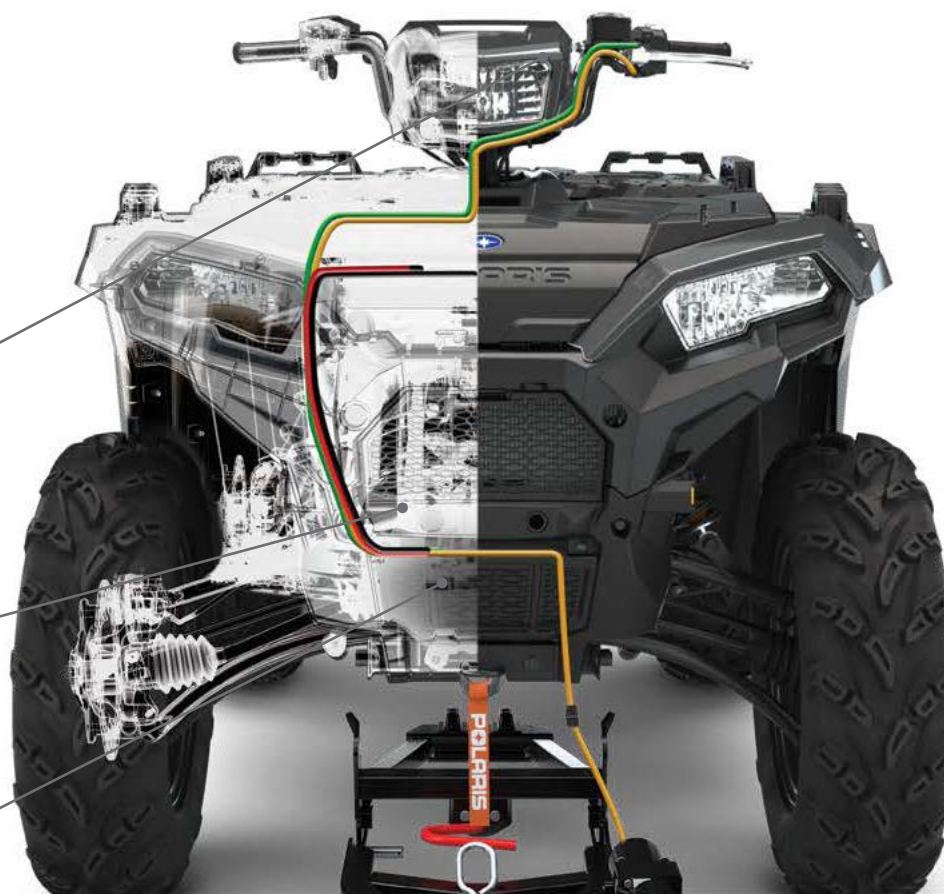

GLACIER
PLOW SYSTEM

P. 46



GLACIER FEATURES

- ✓ Easily engage and disengage the plow system from your Polaris Sportsman
- ✓ No loss of factory ground clearance when not plowing
- ✓ Don't have to crawl under the machine to release the plow blade from the vehicle
- ✓ No trimming of vehicle plastic or fascia required to mount plow or winch

WINCHES P. 12

POLARIS.COM/WINCHES

POLARIS WINCH FEATURES



✓ Tested **1,200+** pulls at max load, it works when you need it to



✓ Built to withstand **-20° F** temperatures



✓ Sealed motor & heavy duty gears **OPERATE FULLY SUBMERGED UNDERWATER**



✓ **MILITARY** tested & approved

PRE-WIRED CHASSIS

Factory-installed wiring makes the controls simple to install. Mount the winch, connect the wires and trust that everything is routed safely, securely, and properly.

NO NEED TO CUT PANELS

FULLY INTEGRATED MOUNT & WIRING



WINCHES



ADD A PLOW
P. 46

WHETHER HARD AT WORK OR ON THE TRAILS, ADD A WINCH TO...

- GET THE JOB DONE RIGHT
- GET YOU ON YOUR WAY FASTER
- BE PREPARED FOR UNEXPECTED SITUATIONS

WHY POLARIS?



TESTED **1,200+**
PULLS AT MAX LOAD



BUILT TO WITHSTAND
-20° F TEMPERATURES



OPERATES FULLY
SUBMERGED



MILITARY
TESTED & APPROVED

REPLACEMENT PART



REPLACEMENT STEEL CABLE

- 2,500 Winch Series - 50 ft.
- » 2878890 • \$59⁹⁹



RECOVERY STRAP

- 2" x 30' (18,000 lb)
- Comes with carry bag
- » 2884033 • \$74⁹⁹

FEATURES

ALL POLARIS ENGINEERED WINCHES COME WITH:



1. Set dial to FREE SPOOL (N) to attach winch hook
2. Set dial to PULL (L) for winch mode
3. Set dial to ROPE RECOVERY (H) for 5x faster rope recovery

AUTO STOP TECHNOLOGY

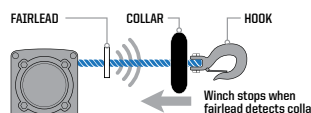

Stops winch at end of pull to prevent driveline stress and plow overlifting

PREMIUM SYNTHETIC ROPE

- Lightweight & Easy to Handle
- Superior Flexibility & Strength
- 50 ft. Long

WIRELESS REMOTE

50 ft. range wireless remote control with unique code for interference-free operation

MODEL

450 H.O. '21
570 '21

450 H.O. '16-20
570 '14-20
X2 570 '15-21
TOURING 570 '14-21
6X6 570 '17-21

850 '12-21
XP 1000 '15-21
TOURING XP 1000 '15-21
TOURING 850 '15-21
SCRAMBLER 850 '14-21

XP 1000 S '20-21
SCRAMBLER XP 1000 S '20-21

PRO PRO HEAVY DUTY SERIES TOP-OF-THE-LINE FEATURES



HID HEAVY DUTY SERIES BUILT FOR THE OFF-ROAD



PRO PRO HEAVY DUTY SERIES

HID HEAVY DUTY SERIES



WARRANTY

- ✓ INTEGRATED WIRING, MOUNT, PREASSEMBLED
- ✓ HOOK WITH STRAP
- ✓ CUT STEEL GEARS & SEALED DRIVETRAIN
- ✓ SEALED PERMANENT MAGNET MOTOR



WITH ALUMINUM FAIRLEAD



NOT AVAILABLE

ADD AUTO STOP TECHNOLOGY WINCH UPGRADE

2881693 • \$134⁹⁹

SYNTHETIC ROPE REQUIRED



WITH STEEL ROLLER FAIRLEAD

ADD SYNTHETIC ROPE

TOP SELLER
2878888 • \$104⁹⁹



ADD WIRELESS WINCH REMOTE

2879316 • \$179⁹⁹



3,500 LB.
with Synthetic Rope

NEW
2884834
\$709⁹⁹

3,500 LB.
with Synthetic Rope

NEW
2884833
\$599⁹⁹

2,500 LB.
with Steel Cable

NEW
2884832
\$519⁹⁹

TOP SELLER

2880434
\$609⁹⁹

TOP SELLER

2880432
\$509⁹⁹

TOP SELLER

2880435
\$609⁹⁹

TOP SELLER

2880433
\$509⁹⁹

2883580
\$709⁹⁹

COMFORT ESSENTIALS



Pro HD 3,500 lb. Winch	P. 16	Rear Brushguard	P. 16	Rigid® D-Series Pro Driving LED Light	P. 48
Trail Brushguard	P. 16	Rear Rack Extender	P. 17	Rear Power Harness	P. 18
LED Light Kit	P. 18	Pro Armor Wheel & Tire Set: Dual Threat/Buckle Accent	P. 43	Handguards - Black	P. 18
Audio Storage Box	P. 19	Lug Nuts	P. 43	Handguard Mount	P. 18
Audio Storage Box Remote	P. 19				

WORK HARD AND GET IT DONE with Polaris Engineered Accessories. Find everything you need to outfit your trusted partner for the task at hand.

WORKER



2,500 lb. Winch	P. 16	Rear Rack Extender	P. 17	Open Cargo Box	P. 19
HD Front Brushguard	P. 16	Pro Armor Wheel & Tire Set: Harvester/Shackle - Matte Black	P. 43	Front Utility Rack	P. 17
Body Armor	P. 17	Lug Nuts	P. 43	Rear Utility Rack	P. 17
Rear Brushguard	P. 16	Mid Windshield	P. 20		

HUNTER



Pro HD 3,500 lb. Winch	P. 16	Gun Boot Mount	P. 50	Rear Power Harness	P. 18
HD Front Brushguard	P. 16	Mid Windshield	P. 20	Pro Armor Wheel & Tire Set: Mud XC/Sixr	P. 43
Rear Rack Extender	P. 17	Gun Boot	P. 50	Lug Nuts	P. 43
Hand & Thumb Warmer Kit	P. 18	Rigid® SR-Series 10" Combo LED Light	P. 48		

WINTER



Pro HD 3,500 lb. Winch	P. 16	Hand & Thumb Warmer Kit	P. 18	Rear Power Harness	P. 18
Glacier® Integrated Plow Mount	P. 47	Windshield - Tall	P. 20	HD Front Brushguard	P. 16
Glacier® Pro Lock & Ride Steel ATV Plow Frame, Black	P. 47	Rear Rack Extender	P. 17	Rear Cargo Box	P. 19
Glacier® Pro Plow Blade - 66" Poly	P. 47	Rigid® SR-Series 10" Combo LED Light	P. 48		

2021 SPORTSMAN 450 • 570



WINCHES

NEW POLARIS PRO HD 3,500 LB. WINCH

- Adds 3,500 lbs of pulling capacity with auto stop technology for plowing applications
- New rapid rope recovery design with standard pulling mode and high-speed recovery which recovers open cable 5 times faster than standard speeds with quick and easy installation

» 2884834 • \$709⁹⁹
570 '21, 450 H.O. '21



INDUSTRY 1ST TECHNOLOGY



LEARN MORE ON P. 12

NEW POLARIS HD 3,500 LB. WINCH

- Adds 3,500 lbs of pulling capacity with a quick and easy installation
- Includes all components required for installation plus 50' of 3/16 premium high-strength synthetic rope

» 2884833 • \$599⁹⁹
570 '21, 450 H.O. '21



NEW POLARIS HD 2,500 LB. WINCH

- Adds 2,500 lbs of pulling capacity with quick and easy installation
- Includes all components required for installation plus 50' of 3/16 high-strength steel cable

» 2884832 • \$519⁹⁹
570 '21, 450 H.O. '21



NEED A PLOW? SEE P. 46

POLARIS.COM/ShopSPORTSMAN

PROTECTION

NEW TRAIL BRUSHGUARD



- Provides enhanced protection from brush and debris
- Has designated light bar holes and is compatible with winch and body armor

» 2884844 • \$259⁹⁹
570 '21, 450 H.O. '21



NEW REAR BRUSHGUARD

- Protect your vehicle from brush, sticks, rocks and light bumps into solid objects
- Made of sturdy 1.25" Steel Tube with a matte black finish

» 2884847 • \$234⁹⁹
570 '21, 450 H.O. '21



NEW HD FRONT BRUSHGUARD WITH HITCH

- Adds heavy duty protection with a custom look
- Has designated light bar holes and is compatible with winch and body armor
- Standard front receiver hitch for additional functionality

» 2884850 • \$389⁹⁹
570 '21, 450 H.O. '21



NEW BODY ARMOR - BLACK

- Provides extra protection to your ATV's full body and fenders

» 2884851 • \$339⁹⁹
570 '21, 450 H.O. '21

Front bumper (2884850 or 2884844) required for installation



NEW SKID PLATE

- Built to be tough from 10mm thick high-density polyethylene

» 2884852 • \$389⁹⁹
570 '21, 450 H.O. '21

RACKS



NEW FRONT RACK EXTENDER

- Forms a 3" tall perimeter around the front cargo rack to keep gear secure which maximizes your cargo capabilities
- Durable steel construction provides a sturdy tie down anchor for loose gear

» 2884840 • \$129⁹⁹
570 '21, 450 H.O. '21



NEW REAR RACK EXTENDER

- Forms a 3" tall perimeter around the rear cargo rack to keep gear secure which maximizes your cargo capabilities
- Durable steel construction provides a sturdy tie down anchor for loose gear
- Compatible with Cargo Boxes and Rear Utility Rack

» 2884841 • \$129⁹⁹
570 '21, 450 H.O. '21



NEW FRONT UTILITY RACK

- Tubular steel rack that attaches on top of front plastic rack providing protection and multiple tie down points
- 3/4" diameter matte black tube steel

» 2884842 • \$169⁹⁹
570 '21, 450 H.O. '21



NEW REAR UTILITY RACK

- Replaces rear plastic rack with a strong flat steel rack with integrated tie down points
- Works with all Lock & Ride accessories, rack extenders, and gun mounts

» 2884843 • \$269⁹⁹
570 '21, 450 H.O. '21

2021 SPORTSMAN 450 • 570



COMFORT



NEW HAND & THUMB WARMER KIT

- Provides heat to grips and throttle and is easily installed by plugging into pod
- Includes two heated grips and one throttle warmer

» 2885002 • \$129⁹⁹
570 '21, 450 H.O. '21



HANDGUARDS

■ BRIGHT WHITE	2876883	\$55 ⁹⁹
■ BLACK	2876846	\$55 ⁹⁹
■ INDY RED	2876845	\$55 ⁹⁹

- Handguard Mount (2879380) is required when installing Polaris Handguards
- Does not fit with windshields or handlebar-mounted mirrors

» 2879380 • MOUNT • \$43⁹⁹ TOP SELLER
570 '21, 450 H.O. '21



NEW HANDLEBAR MOUNTED MIRRORS TOP SELLER

- For added safety on or off the trail
- Sold as a pair
- Does not fit with windshield fairing or handguards

» 2877222 • \$54⁹⁹
570 '21, 450 H.O. '21



NEW LED LIGHT KIT

- Upgrade your standard headlights and pod lights to LEDs with this upgrade kit

» 2884859 • \$519⁹⁹
'570 '21, 450 H.O. '21



NEW REAR POWER HARNESS

- Provides power to the rear of the ATV for electrical accessories including Rear Audio Storage Box

» 2889070 • \$109⁹⁹
570 '21, 450 H.O. '21

AUDIO



NEW REAR AUDIO STORAGE BOX LOCK & RIDE

- Dual 6" Speakers by Rockford Fosgate® that connect via Bluetooth
- Mounts easily with Lock & Ride to the rear rack and is compatible with rack extenders, utility rack, and gun mount
- Rest easy knowing that your speakers are protected with a sealed lid container
- Rear power harness required for installation (2889070)

» 2884856 • \$779⁹⁹
570 '21, 450 H.O. '21



NEW AUDIO STORAGE BOX REMOTE

- Easily control the volume or switch to the next song on your Rear Audio Storage Box that conveniently mounts to your ATV's handlebars

» 2884987 • \$129⁹⁹
570 '21, 450 H.O. '21

STORAGE

NEW REAR CARGO BOX LOCK & RIDE

- Increase your storage with an extra 21.25 gallons of dry, dust-proof storage
- Mounts easily with Lock & Ride to the rear rack and is compatible with rack extenders, utility rack, and gun mount
- Includes 2 padlock locations

» 2884853 • \$414⁹⁹
570 '21, 450 H.O. '21



NEW OPEN CARGO BOX LOCK & RIDE

- Increase your storage with an extra 22 gallons of convenient storage space
- Mounts easily with Lock & Ride to the rear rack and is compatible with rack extenders, utility rack, and gun mount
- Holds 2, 5-gallon buckets with integrated grab handle to make it easy to carry and transport cargo
- 12 convenient tie-down locations to secure cargo

» 2884854 • \$269⁹⁹
570 '21, 450 H.O. '21



NEW REAR COOLER BOX LOCK & RIDE

- Increase your storage with an extra 46 quarts of weather resistant cooler storage
- Mounts easily with Lock & Ride to the rear rack and is compatible with rack extenders, utility rack, and gun mount
- Integrated bottle opener and 2 padlock locations

» 2884857 • \$519⁹⁹
570 '21, 450 H.O. '21



2021 SPORTSMAN 450 • 570



WINDSHIELDS



Tall 18" Clear



Mid 14" Clear



Short 9" Clear

NEW

LOCK & RIDE SPORTSMAN WINDSHIELDS

- Lock & Ride technology allows for easy installation and removal in seconds without tools
- Lock & Ride mounts allow a rider to adjust the height and angle of the windshield
- Poly windshields are flexible, impact-resistant, and provide long-term value over the life of your machine
- Three heights available for whatever coverage you prefer
- Does not work with handguards

SIZE	COLOR	PART #	PRICE
TALL 18"	CLEAR	2884945	\$234 ⁹⁹
MID 14"	CLEAR	2884845	\$219 ⁹⁹
SHORT 9"	CLEAR	2884946	\$209 ⁹⁹

570 '21, 450 H.O. '21



DO MORE

LIGHTING SEE P. 48



HUNT SEE P. 50



PLOWS SEE P. 46



WHEELS & TIRES SEE P. 38



2014-2021 SPORTSMAN 570 6X6 570 TOURING 570 X2



WINCHES

POLARIS HD 3,500 LB. WINCH TOP SELLER

» 2880434 • \$609⁹⁹
X2 570 '15-21, TOURING 570 '14-21,
6X6 570 '17-21



POLARIS HD 2,500 LB. WINCH

» 2880432 • \$509⁹⁹
X2 570 '15-21, TOURING 570 '14-21,
6X6 570 '17-21



NEED A PLOW? SEE P. 46

STORAGE

SEMI-RIGID TOURING CARGO BAG

- Large-capacity, heavy-duty vinyl bag
- Three zippered openings, removable dividers
- Attaches to rack with Velcro® straps

» 2877220 • \$209⁹⁹
TOURING 570 '14-21



FENDER BAG

- Ideal for holding items you want to keep close at hand such as glasses, gloves, or water bottles
- Easy to access contents while seated

» 2876604 • \$74⁹⁹
X2 570 '15-21, TOURING 570 '14-21, 6X6 570 '17-21



COMFORT



HAND WARMERS TOP SELLER

» 2877363 • \$79⁹⁹
X2 570 '15-21, TOURING 570 '14-21, 6X6 570 '17-21

HANDGUARDS

- BRIGHT WHITE 2876883 \$55⁹⁹
- BLACK 2876846 \$55⁹⁹
- INDY RED 2876845 \$55⁹⁹

- Handguard Mount (2879380) is required when installing Polaris Handguards
- Does not fit with windshields or handlebar-mounted mirrors

» 2879380 • MOUNT • \$43⁹⁹ TOP SELLER
X2 570 '15-21, TOURING 570 '14-21, 6X6 570 '17-21



THROTTLE/THUMB WARMER TOP SELLER

» 2877364 • \$64⁹⁹
X2 570 '15-21, TOURING 570 '14-21, 6X6 570 '17-21



HANDLEBAR MOUNTED MIRRORS TOP SELLER

- For added safety on or off the trail
- Sold as a pair
- Does not fit with windshield fairing or handguards

» 2877222 • \$54⁹⁹
X2 570 '15-21, TOURING 570 '14-21, 6X6 570 '17-21

PROTECTION, RACKS & WINDSHIELDS



FRONT BRUSHGUARD TOP SELLER

» 2879714 • \$249⁹⁹
X2 570 '15-21, TOURING 570 '14-21, 6X6 570 '17-21



REAR BRUSHGUARD TOP SELLER

» 2879715 • \$229⁹⁹
TOURING 570 '14-21

ULTIMATE SERIES – RACK EXTENDER 4"



FRONT TOP SELLER

» 2879716 • \$134⁹⁹
X2 570 '15-21, TOURING 570 '14-21, 6X6 570 '17-21

LOCK & RIDE SPORTSMAN WINDSHIELDS TOP SELLER

- Windshield installs/removes in seconds without tools
- Lock & Ride mounts allow adjustment of height and angle
- Poly windshields are flexible, impact-resistant, and provide long-term value over the life of your machine
- Does not work with handguards

SIZE	COLOR	PART #	PRICE
TALL 19.25"	CLEAR	2880539-409	\$219 ⁹⁹
MID 15.5"	SMOKE	2880540-412	\$209 ⁹⁹

X2 570 '18-21, TOURING 570 '18-21



LOCK & RIDE

YUKON ADVENTURE RACK

- Adds increased storage volume by allowing you to increase storage height securely

» 2882084 • \$409⁹⁹
6X6 570 '17-21



Tall 19.25" Clear



Mid 15.5" Smoke

2014-2020 SPORTSMAN 450 • 570

WINCHES

POLARIS HD 3,500 LB. WINCH TOP SELLER

» 2880434 • \$609⁹⁹
570 '14-20, 450 H.O. '16-20



POLARIS HD 2,500 LB. WINCH TOP SELLER

» 2880432 • \$509⁹⁹
570 '14-20, 450 H.O. '16-20



NEED A PLOW? SEE P. 46

PROTECTION



FRONT BRUSHGUARD TOP SELLER

» 2879714 • \$249⁹⁹
570 '14-20, 450 H.O. '16-20



REAR BRUSHGUARD TOP SELLER

» 2879715 • \$229⁹⁹
570 '14-20, 450 H.O. '16-20

RACKS

ULTIMATE SERIES – RACK EXTENDER 4"



FRONT TOP SELLER

» 2879716 • \$134⁹⁹
570 '14-20, 450 H.O. '16-20

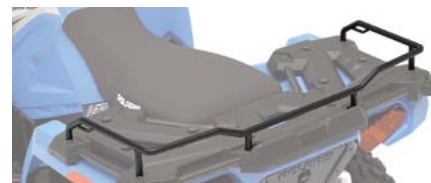

REAR TOP SELLER

» 2879717 • \$149⁹⁹
570 '14-20, 450 H.O. '16-20

STORAGE



LOCK & RIDE REAR CARGO BOX TOP SELLER

- Increase your storage with an extra 25 gallons of capacity
- Store two full-size helmets
- Works with Rack Extenders
- Will not fit when Utility Rack is installed

» 2882882 • \$409⁹⁹
570 '14-20, 450 H.O. '12-20



COMFORT



HAND WARMERS TOP SELLER

» 2877363 • \$79⁹⁹
570 '14-20, 450 H.O. '12-20



THROTTLE/THUMB WARMER TOP SELLER

» 2877364 • \$64⁹⁹
570 '14-20, 450 H.O. '12-20



HANDGUARDS

<input type="checkbox"/> BRIGHT WHITE	2876883	\$55 ⁹⁹
<input checked="" type="checkbox"/> BLACK	2876846	\$55 ⁹⁹
<input checked="" type="checkbox"/> INDY RED	2876845	\$55 ⁹⁹

- Handguard Mount (2879380) is required when installing Polaris Handguards
- Does not fit with windshields or handlebar-mounted mirrors

» 2879380 • MOUNT • \$43⁹⁹ TOP SELLER



HANDLEBAR MOUNTED MIRRORS TOP SELLER

- For added safety on or off the trail
- Sold as a pair
- Does not fit with windshield fairing or handguards

» 2877222 • \$54⁹⁹
570 '14-20, 450 H.O. '12-20

WINDSHIELDS



Tall 19.25" Clear



Mid 15.5" Smoke

LOCK & RIDE SPORTSMAN WINDSHIELDS TOP SELLER

- Windshield installs/removes in seconds without tools
- Lock & Ride mounts allow adjustment of height and angle
- Poly windshields are flexible, impact-resistant, and provide long-term value over the life of your machine
- Does not fit with handguards

SIZE	COLOR	PART #	PRICE
TALL 19.25"	CLEAR	2880539-409	\$219 ⁹⁹
MID 15.5"	SMOKE	2880540-412	\$209 ⁹⁹

570 '18-20, 450 H.O. '18-20

COMFORT ESSENTIALS



Winches	P. 28	Storage	P. 30
Protection	P. 29	Lighting	P. 48
Racks/Rack Extenders	P. 28	Wheels & Tires	P. 38
Windshields	P. 32		

HUNTER



Winches	P. 28	Hunting Accessories	P. 50
Protection	P. 29	Lighting	P. 48
Racks/Rack Extenders	P. 28	Wheels & Tires	P. 38
Windshields	P. 32		

WORK HARD AND GET IT DONE with Polaris Engineered Accessories. Find everything you need to outfit your trusted partner for the task at hand.

WORKER



Winches	P. 28	Storage	P. 30
Protection	P. 29	Lighting	P. 48
Racks/Rack Extenders	P. 28	Wheels & Tires	P. 38
Windshields	P. 32		

WINTER



Winches	P. 28	Plow System	P. 46
Protection	P. 29	Lighting	P. 48
Rack Extenders	P. 29	Wheels & Tires	P. 38
Windshields	P. 32		

SPORTSMAN 850 XP 1000 XP 1000 S



WINCHES

POLARIS PRO HD 3,500 LB. WINCH

- » 2883580 • \$709⁹⁹
XP 1000 S '20-21
- » 2882241 • \$699⁹⁹
XP 1000 '15-21, TOURING XP 1000 '15-21,
TOURING 850 '12-21, 850 '12-21



INDUSTRY 1ST TECHNOLOGY

RAPID ROPE RECOVERY



LEARN MORE ON P. 12

POLARIS HD 3,500 LB. WINCH TOP SELLER

- » 2880435 • \$609⁹⁹
XP 1000 '15-21, TOURING XP 1000 '15-21,
TOURING 850 '12-21, 850 '12-21



POLARIS HD 2,500 LB. WINCH

- » 2880433 • \$509⁹⁹
XP 1000 '15-21, TOURING XP 1000 '15-21,
TOURING 850 '12-21, 850 '12-21



NEED A PLOW? SEE P. 46

RACKS

ULTIMATE SERIES – RACK EXTENDER 4"

FRONT

- » 2882022 • \$134⁹⁹
XP 1000 S '20-21, XP 1000 '17-21,
850 '17-21



REAR

- » 2882023 • \$149⁹⁹
XP 1000 S '20-21, XP 1000 '17-21,
850 '17-21
Fits with Rear Cargo Box (2882882)



ULTIMATE SERIES – RACK EXTENDER 7"

FRONT

- » 2882024 • \$209⁹⁹
XP 1000 S '20-21, XP 1000 '17-21, 850 '17-21

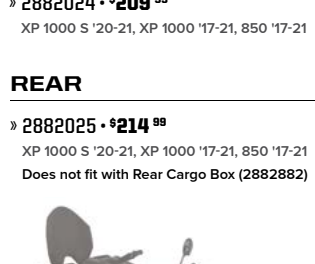

REAR

- » 2882025 • \$214⁹⁹
XP 1000 S '20-21, XP 1000 '17-21, 850 '17-21
Does not fit with Rear Cargo Box (2882882)



FRONT RACK EXTENDER

- » 2879890 • \$134⁹⁹
TOURING XP 1000 '15-21, TOURING 850 '21
Does not fit with Front Cargo Box installed



ULTIMATE SERIES – STEEL RACK

FRONT

- » 2883257 • \$209⁹⁹
XP 1000 S '20-21, XP 1000 '17-21,
850 '17-21



REAR

- » 2883258 • \$269⁹⁹
XP 1000 S '20-21, XP 1000 '17-21,
850 '17-21



ULTIMATE SERIES – MOVEABLE TIE-DOWN POINTS

- » 2882270 • \$74⁹⁹
(FRONT & REAR - SOLD IN PAIRS)
XP 1000 '17-21, 850 '17-21



PROTECTION

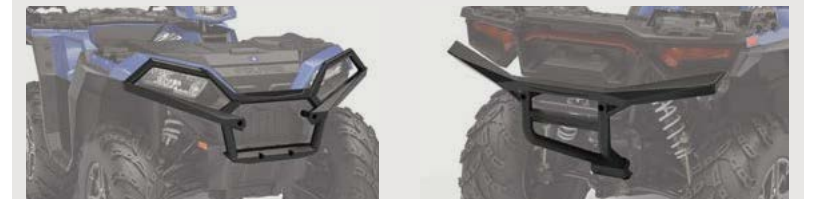

SPORTSMAN ULTIMATE SERIES – BRUSHGUARD

- Quick installation to the integrated mounting tubes on the vehicle using wedge-style expansion anchor mounts
- Attach the Body Armor to the Front Brushguard to provide the ultimate protection for the front fenders

- » 2882020 • FRONT • \$339⁹⁹ TOP SELLER
XP 1000 S '20-21, XP 1000 '17-21, 850 '17-21
- » 2882583 • REAR • \$269⁹⁹
XP 1000 '17-21, 850 '17-21



SPORTSMAN ULTIMATE SERIES – BODY ARMOR

- Securely mounts to Ultimate Series Sportsman XP Front Brushguard (2882020)
- Comes as pair
- » 2882090 • \$409⁹⁹
XP 1000 '17-21, 850 '17-21



SPORTSMAN TOURING XP BRUSHGUARD

- Adds heavy-duty protection and a custom look
- » 2878709 • FRONT • \$299⁹⁹
TOURING XP 1000 '15-21, TOURING 850 '10-21

- » 2878324 • REAR • \$219⁹⁹
TOURING XP 1000 '15-21,
TOURING 850 '10-21

SPORTSMAN 850 XP 1000 XP 1000 S



STORAGE



NEW REAR CARGO BOX LOCK & RIDE

- Increase your storage with an extra 21.25 gallons of dry, dust-proof storage
- Mounts easily with Lock & Ride to the rear rack and is compatible with rack extenders and gun mount
- Includes 2 padlock locations
- Will not fit when Ultimate Series Steel Rack is installed

» 2884853 • **\$414**⁹⁹
XP 1000 S '20-21, XP 1000 '17-21, 850 '17-21



NEW OPEN CARGO BOX LOCK & RIDE

- Increase your storage with an extra 22 gallons of convenient storage space
- Mounts easily with Lock & Ride to the rear rack and is compatible with rack extenders and gun mount
- Holds 2, 5-gallon buckets with integrated grab handle to make it easy to carry and transport cargo
- 12 convenient tie-down locations to secure cargo
- Includes 2 padlock locations
- Will not fit when Ultimate Series Steel Rack is installed

» 2884854 • **\$269**⁹⁹
XP 1000 S '20-21, XP 1000 '17-21, 850 '17-21



NEW REAR COOLER BOX LOCK & RIDE

- Increase your storage with an extra 46 quarts of weather resistant cooler storage space
- Mounts easily with Lock & Ride to the rear rack and is compatible with rack extenders and gun mount
- Integrated bottle opener and 2 padlock locations
- Will not fit when Ultimate Series Steel Rack is installed

» 2884857 • **\$519**⁹⁹
XP 1000 S '20-21, XP 1000 '17-21, 850 '17-21



ULTIMATE SERIES – READY PACK

- Keep your trail essentials at the ready with this easy-to-access, weather-resistant storage compartment

» 2882271 • **\$89**⁹⁹
XP 1000 '17-21, 850 '17-21



FRONT CARGO BOX LOCK & RIDE

» 2877951 • **\$229**⁹⁹
TOURING XP 1000 '15-21, TOURING 850 '10-21
The Front Rack Extender cannot be installed at the same time as the storage box



REAR STORAGE BOX LOCK & RIDE

» 2878000 • **\$259**⁹⁹
TOURING XP 1000 '15-21, TOURING 850 '10-21
Slight interference with Sportsman Touring 550/850 '11-14 passenger handles

AUDIO



NEW REAR AUDIO STORAGE BOX LOCK & RIDE

- Dual 6" Speakers by Rockford Fosgate® that connect via Bluetooth®
- Mounts easily with Lock & Ride to the rear rack and is compatible with rack extenders and gun mount
- Rest easy knowing that your speakers are protected with a sealed lid container
- Rear power harness required for installation (2889071)

» 2884856 • **\$779**⁹⁹
XP 1000 S '20-21, XP 1000 '17-21, 850 '17-21



NEW AUDIO STORAGE BOX REMOTE

- Easily control the volume or switch to the next song on your Rear Audio Storage Box that conveniently mounts to your ATV's handlebars

» 2884987 • **\$129**⁹⁹
XP 1000 S '20-21, XP 1000 '17-21, 850 '17-21

COMFORT



HANDLEBAR MOUNTED MIRRORS TOP SELLER

- For added safety on or off the trail
- Sold as a pair
- Does not fit with windshield fairing or handguards

» 2877222 • **\$54**⁹⁹
XP 1000 S '20-21, XP 1000 '15-21, TOURING XP 1000 '15-21, TOURING 850 '10-21, 850 '09-21



HANDGUARDS

■ BRIGHT WHITE	2876883	\$55 ⁹⁹
■ BLACK	2876846	\$55 ⁹⁹
■ INDY RED	2876845	\$55 ⁹⁹

- Handguard Mount (2879380) is required when installing Polaris Handguards
- Does not fit with windshields or handlebar-mounted mirrors

» 2879380 • MOUNT • **\$43**⁹⁹ TOP SELLER

XP 1000 S '20-21, XP 1000 '15-21, TOURING XP 1000 '15-21, TOURING 850 '10-21, 850 '09-21



NEW HAND & THUMB WARMER KIT

- Provides heat to grips and throttle and is easily installed by plugging into pod
- Includes two heated grips and one throttle warmer

» 2885002 • **\$129**⁹⁹
XP 1000 S '21, XP 1000 '21, 850 '21



HAND WARMERS TOP SELLER

» 2877363 • **\$79**⁹⁹
XP 1000 S '20, XP 1000 '15-20, TOURING XP 1000 '15-21, TOURING 850 '15-21



THROTTLE/THUMB WARMERS TOP SELLER

» 2877364 • **\$64**⁹⁹
XP 1000 S '20-21, XP 1000 '15-20, TOURING XP 1000 '15-21, TOURING 850 '15-21



NEW REAR POWER HARNESS

- Provides power to the rear of the ATV for electrical accessories including Rear Audio Storage Box

» 2889071 • **\$109**⁹⁹
XP 1000 S '20-21, XP 1000 '15-20, TOURING XP 1000 '15-21, TOURING 850 '10-21, 850 '09-21

SPORTSMAN 850 XP 1000 XP 1000 S



WINDSHIELDS

NEW

LOCK & RIDE SPORTSMAN WINDSHIELDS

- Provides enhanced protection from the elements and off-road hazards
- Easily installs and removes without tools utilizing Lock & Ride Technology
- Improved mounting system for easier and quicker attachment and detachment

SIZE	COLOR	PART #	PRICE
TALL 18"	CLEAR	2884945	\$234 ⁹⁹
MID 14"	CLEAR	2884845	\$219 ⁹⁹
SHORTS 9"	CLEAR	2884946	\$209 ⁹⁹

XP 1000 S '21, XP 1000 '21, 850 '21



Tall 18" Clear

Mid 14" Clear

Short 9" Clear

LOCK & RIDE WINDSHIELDS TOP SELLER

- Windshield installs in seconds without tools with its Lock & Ride technology. It can also be removed in seconds without tools
- Lock & Ride mounts allow a rider to adjust the height and angle of the windshield
- Poly windshields are flexible, impact-resistant, and provide long-term value over the life of your machine
- Does not work with handguards

SIZE	COLOR	PART #	PRICE
TALL 48.9 cm	CLEAR	2880539-409	\$219 ⁹⁹
MID 39.4 cm	SMOKE	2880540-412	\$209 ⁹⁹

TOURING XP 1000 '15-21, TOURING 850 '15-21



Tall 19.25" Clear

Mid 15.5" Smoke

LOCK & RIDE ULTIMATE SERIES WINDSHIELD FAIRING

- Customizable system based on your style and protection needs
- Install just the fairing or add any of the windshields listed to the right
- Does not work with handguards or handlebar mounted mirror

» 2882512 • \$209⁹⁹

XP 1000 S '20, XP 1000 '17-20, 850 '17-20



ULTIMATE SERIES WINDSHIELDS

- Fairing required to add your preferred windshield

SIZE	PART #	PRICE
TALL	2882152	\$134 ⁹⁹
MID	2882151	\$124 ⁹⁹

XP 1000 S '20, XP 1000 '17-20, 850 '17-20



EASY TO CHANGE WINDSHIELDS WITH 6-DART INSTALL

Our fairing system allows for changing out the windshield quickly and easily. Simply remove the six dart-type fasteners and swap out the windshield.

DO MORE

LIGHTING

SEE P. 48



PLOWS

SEE P. 46



HUNT

SEE P. 50



WHEELS & TIRES

SEE P. 38



SCRAMBLER 850 XP 1000 S



WINCH



POLARIS PRO HD 3,500 LB. WINCH

- » 2883580 • \$709⁹⁹
SCRAMBLER XP 1000 S '20-21
- » 2882241 • \$699⁹⁹
SCRAMBLER 850 '14-21, SCRAMBLER XP 1000 '14-18



POLARIS TOP SELLER HD 3,500 LB. WINCH

- » 2880435 • \$609⁹⁹
SCRAMBLER 850 '14-21, SCRAMBLER XP 1000 '14-18



POLARIS HD 2,500 LB. WINCH

- » 2880433 • \$509⁹⁹
SCRAMBLER 850 '14-21, SCRAMBLER XP 1000 '14-18

RACKS/STORAGE



LARGE REAR RACK

- » 2879139 • \$219⁹⁹
SCRAMBLER XP 1000 S '20-21, SCRAMBLER XP 1000 '14-18,
SCRAMBLER 850 '14-21
Not compatible with Ogio® Bag (2879925)



OGIO® BAG

- » 2879925 • \$229⁹⁹
SCRAMBLER XP 1000 S '20-21, SCRAMBLER XP 1000 '14-18,
SCRAMBLER 850 '14-21

PROTECTION



ULTIMATE SPORT SERIES FRONT BRUSHGUARD

- » 2883595 • \$324⁹⁹
SCRAMBLER XP 1000 S '20-21



FRONT BRUSHGUARD

- » 2879136 • \$269⁹⁹
SCRAMBLER 850 '14-21, SCRAMBLER XP 1000 '14-18
Replaces existing lower bumper. Will not work together



REAR BASH GUARD

- » 2879138 • \$189⁹⁹
SCRAMBLER 850 '14-21, SCRAMBLER XP 1000 '14-18

MISC SPORTSMAN ACCESSORIES



BOOM SPRAYER

- » 2882266 • \$539⁹⁹
ALL SPORTSMAN MODELS EXCEPT TOURING

ATV LICENSE PLATE

- Includes numbers and letters
- » 2873270 • \$20⁹⁹
ALL SPORTSMAN MODELS



QUICKTAP BATTERY POSTS

- Easy-to-access terminal posts give you quick access to the battery power
- Ideal for charging your battery, powering a temporary accessory, or when you need to offer an unexpected jump-start
- Connection posts feature covers to protect terminals when not in use
- » 2882110 • \$74⁹⁹
X2 570 '15-21, TOURING 570 '14-21, 6X6 570 '17-21,
570 '14-20, 450 H.O. '19-20



RIDE & REPAIR ESSENTIALS KIT

- 12-volt DC portable air compressor
- Tire repair kit with 6 plugs
- Basic first-aid kit with bandages, scissors, safety pins, and more
- 12-volt jumper cables
- Duct tape - 300mm x 1 roll
- Zip ties - 150mm length
- Electrical tape
- Ratchet strap - 50mm
- Microfiber cloth
- Carry bag
- » 2881207 • \$134⁹⁹

YOUTH ATVs

The perfect first All-Terrain Vehicle for kids starting at 6 years and older.



OUTLAW 70 EFI



NEW FRONT BRUSHGUARD

- Provides enhanced protection from brush and other debris on the trail

» 2884567 • \$159⁹⁹

OUTLAW 70 '21



NEW REAR BRUSHGUARD

- Protect the rear of your youth ATV from hazards on the trails

» 2884778 • \$55⁹⁹

OUTLAW 70 '21



NEW WINDSHIELD - POLY

- Added wind and hand protection with a durable poly design

» 2885005 • \$129⁹⁹

OUTLAW 70 '21

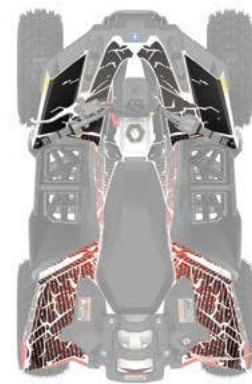

NEW DECAL KIT - INDY RED

- Replaces the stock Outlaw 70 decals to provide a unique and custom look for your youth ATV

» 2885107 • \$119⁹⁹

OUTLAW 70 '21



NEW REAR STORAGE BAG

- Convenient storage that easily connects to the rear rack of your youth ATV

» 2884555 • \$89⁹⁹

OUTLAW 70 '21

YOUTH WHEELS & TIRES

NEW YOUTH CRAWLER TIRE

- Upgraded youth tire for added durability
- Increased ground clearance and performance

ACE 150 '17-21



	TREAD DEPTH	TIRE WEIGHT	PLY RATING	SIDEWALL BELTS	LOAD RATING	
18" 22" x 8" R12 5416945 • \$129 ⁹⁹	FRONT	13 mm	18 lbs	6	3	910 lbs
18" 22" x 10" R12 5416944 • \$144 ⁹⁹	REAR					

NEW YOUTH BUCKLE - BLACK

» FRONT • 1524114 • \$119⁹⁹

ACE 150 '17-21

» REAR • 1524115 • \$129⁹⁹

ACE 150 '17-21



NEW PRO ARMOR WHEEL & TIRE SET: YOUTH CRAWLER & BUCKLE

» 2885154 • \$959⁹⁹

ACE 150 '17-21



ACE 150



POLY ROOF

» 2882263 • \$179⁹⁹

ACE 150 '17-21

HALF POLY WINDSHIELD

» 2882264 • \$134⁹⁹

ACE 150 '17-21

FRONT & REAR BRUSHGUARD SET

» 2882472 • \$134⁹⁹

ACE 150 '17-21

KNOW YOUR TERRAIN



- Tread patterns optimized for extreme traction
- Ideal for both hard pack and loose trail



- Flexible "grippy" tread
- Aggressive side bite



- Provides traction and durability
- Built to perform in hard sand, jagged rocks or any other extreme terrain



- Extra deep treads
- Self-cleaning lugs



- Paddles provide traction and durability in soft sand
- Built to float on top of sand



- Industry leading anti-puncture side walls
- Purpose-built, long lasting tread patterns



- Handles extreme cold
- Holds shape and provides traction

SUPERIOR PERFORMANCE & DURABILITY

WAYS TO SHOP TIRES



PRO ARMOR

LIFELONG PERFORMANCE

- Every tire is designed and constructed with longevity in mind
- 3,000+ mile rated (4,828 kilometers)

PREMIUM PROTECTION

- Pro Armor makes tires with extra protection exactly where it's needed most—the sidewall
- Triple-belted sidewalls keep your tires more resistant so you can keep going

TOUGHEST TIRES

- Higher ply ratings mean added protection
- Pro Armor builds 8 or 10-ply rated tires for higher puncture-resistance

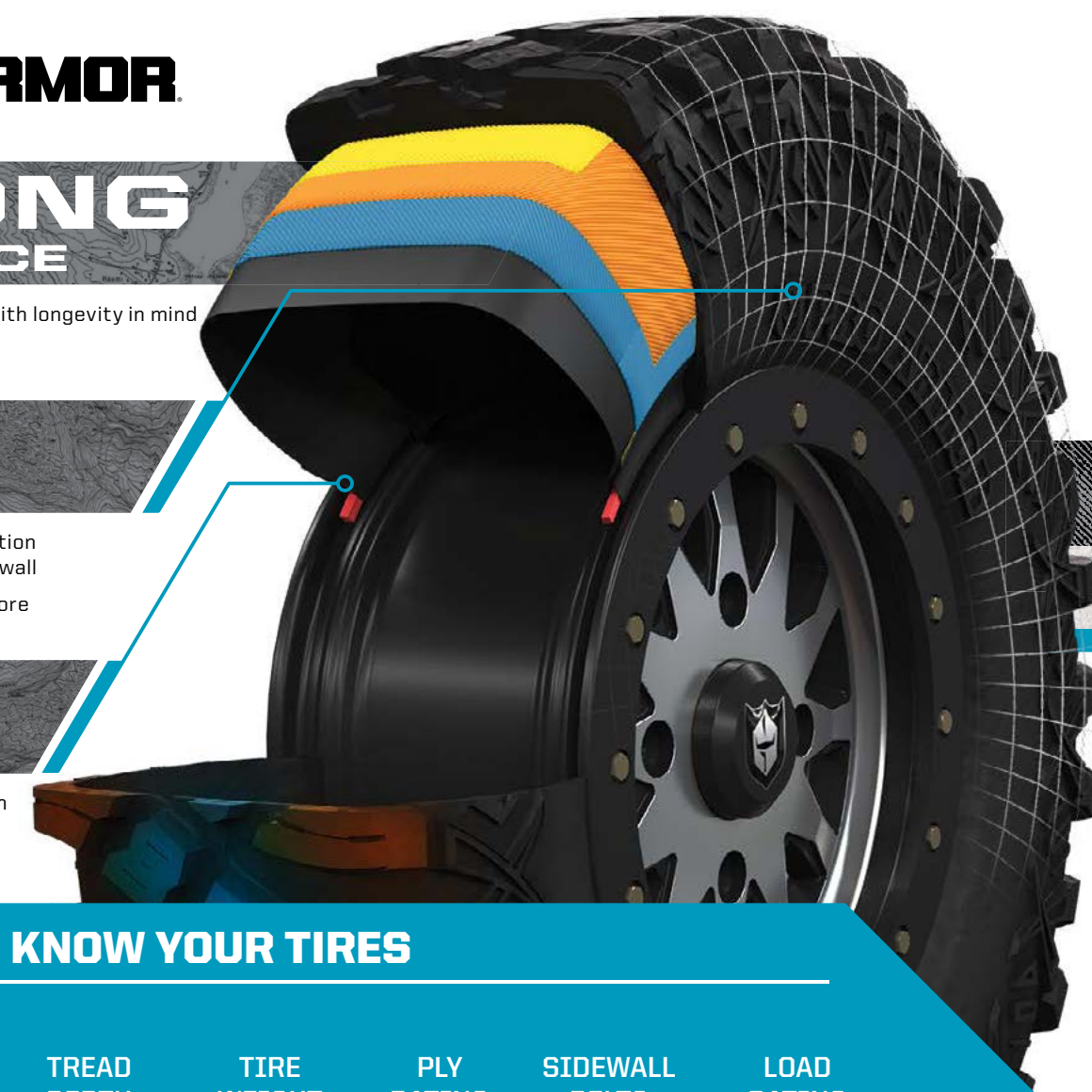

KNOW YOUR TIRES

DIMENSIONS			TREAD DEPTH	TIRE WEIGHT	PLY RATING	SIDEWALL BELTS	LOAD RATING
TIRE HEIGHT	TIRE WIDTH	WHEEL DIAMETER					
32" x 9"	R15	FRONT/REAR	30 mm	41 lbs	10	3	1,320 lbs
Part Number • Price							

USAGE
Where can you use the tire

TREAD DEPTH
Deeper treads have more grip in all conditions

TIRE WEIGHT
A lighter tire makes for improved vehicle performance

PLY RATING
Indicates tire puncture-resistance

SIDEWALL BELTS
Increase your resistance to sidewall punctures

LOAD RATING
How much weight can the tire handle

TIRES BY SIZE

26"	27"
ATTACK	MUD XC
DUAL-THREAT	PRESERVE
	HARVESTER
	WHITEOUT

TIRES BY TERRAIN

TRAIL	ROCK	DESERT	MUD	UTILITY	SNOW
DUAL-THREAT	DUAL-THREAT	DUAL-THREAT	MUD XC	ATTACK	ATTACK
ATTACK	ATTACK	ATTACK		HARVESTER	HARVESTER
HARVESTER				PRESERVE	PRESERVE
PRESERVE				XD-K	XD-K
XD-K					WHITEOUT
MUD XC					

TIRES



PRO ARMOR DUAL-THREAT

- Dual-compound technology and radial construction offer performance in all terrains
- Softer durometer rubber on outer edge for overall superior grip and feel
- Harder durometer rubber in the middle for increase traction during acceleration and longer tread life

		TREAD DEPTH	TIRE WEIGHT	PLY RATING	SIDEWALL BELTS	LOAD RATING
14"	26" x 9" R14 5416340 • \$219 ⁹⁹	16 mm	27 lbs	10	3	910 lbs
14"	26" x 11" R14 5416341 • \$229 ⁹⁹		30 lbs			1,100 lbs



FRONT/REAR

WHEEL SIZE

14"



PRO ARMOR ATTACK

- The best all-purpose tire for all-season traction in any terrain
- Unique full-face tread design
- Harder durometer lugs promote extended wear, increasing tire life

		TREAD DEPTH	TIRE WEIGHT	PLY RATING	SIDEWALL BELTS	LOAD RATING
14"	26" x 9" R14 5415613 • \$189 ⁹⁹	23 mm	28 lbs	8	3	910 lbs
14"	26" x 11" R14 5415614 • \$209 ⁹⁹		32 lbs			1,320 lbs



FRONT/REAR

WHEEL SIZE

14"

TIRES



PRO ARMOR HARVESTER

- All-around workhorse with tread life of 5,000 miles / 8,047 kilometers
- Tread pattern designed to withstand anything from the farmyard to the pastures to the trail
- With 10-ply, it can carry the load day-in and day-out

	TREAD DEPTH	TIRE WEIGHT	PLY RATING	SIDEWALL BELTS	LOAD RATING	
14" 14" 26" x 8" R12 5416396 • \$229 ⁹⁹	FRONT	24 lbs			855 lbs	
12" 12" 26" x 10" R12 5415966 • \$249 ⁹⁹	REAR	16 mm	32 lbs	10	3	1,320 lbs
12" 12" 27" x 10" R14 5415965 • \$249 ⁹⁹	FRONT/REAR		32 lbs			1,320 lbs



FRONT/REAR



PRO ARMOR WHITEOUT

- Extra wide tires for flotation in snow
- Tread pattern designed for superior snow traction with limited digging

	TREAD DEPTH	TIRE WEIGHT	PLY RATING	SIDEWALL BELTS	LOAD RATING	
14" 14" 27" x 14" R14 5416032 • \$369 ⁹⁹	FRONT/REAR	16 mm	24 lbs	8	3	935 lbs



FRONT/REAR



PRO ARMOR PRESERVE

- Turf-friendly for areas where low impact from tire tread is needed
- Exceptionally quiet-running tire
- Low impact tire

	TREAD DEPTH	TIRE WEIGHT	PLY RATING	SIDEWALL BELTS	LOAD RATING	
14" 14" 27" x 10" R14 5416348 • \$249 ⁹⁹	FRONT	24 lbs			855 lbs	
12" 12" 26" x 10" R12 5416402 • \$249 ⁹⁹	REAR	16 mm	28 lbs	10	3	1,320 lbs
12" 12" 26" x 8" R12 5416403 • \$229 ⁹⁹	FRONT/REAR		29 lbs			1,320 lbs



FRONT/REAR

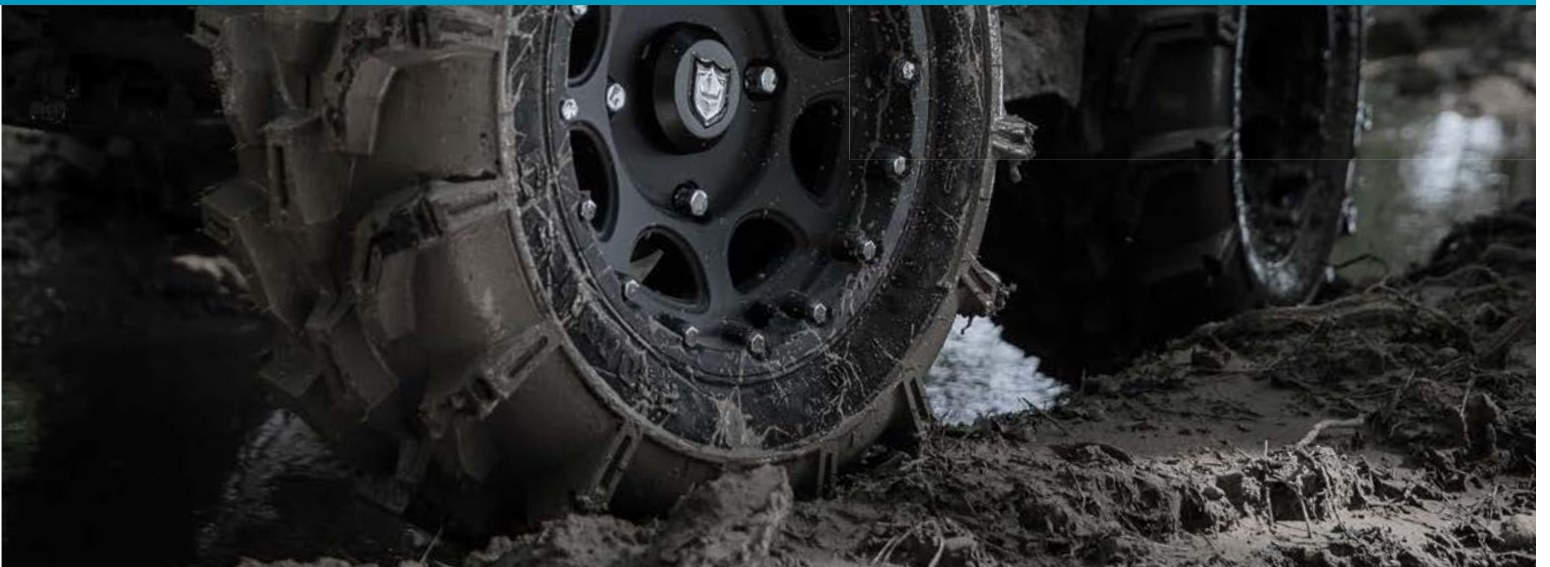

PRO ARMOR XD-K

- 26" Aramid fiber-belted tire can tackle any terrain
- Unique full-face tread design
- Harder durometer lugs promotes for extended wear increasing tire life

	TREAD DEPTH	TIRE WEIGHT	PLY RATING	SIDEWALL BELTS	LOAD RATING	
12" 12" 26" x 9" R12 5415756 • \$278 ⁹⁹	FRONT	28 lbs			935 lbs	
12" 12" 26" x 11" R12 5415757 • \$293 ⁹⁹	REAR	31.7 mm	32 lbs	8	3/1 Aramid	1,330 lbs



FRONT/REAR



PRO ARMOR MUD XC

- Designed for the perfect mud-trail crossover for a smooth ride on the trail and aggressive traction in the mud
- Dual-compound technology with harder durometer lugs promote extended wear, increasing tire life
- 10-ply construction, means added protection in the toughest terrain

	TREAD DEPTH	TIRE WEIGHT	PLY RATING	SIDEWALL BELTS	LOAD RATING	
14" 14" 27" x 9" R14 5416947 • \$249 ⁹⁹	FRONT	30 lbs			1,170 lbs	
14" 14" 27" x 11" R14 5416948 • \$259 ⁹⁹	REAR	30 mm	32 lbs	10	3	1,320 lbs



FRONT/REAR

COMMON

WINCHES

450-570

850-XP1000-XP1000S

SCRAMBLER 850-XP1000S

MISC & YOUTH

WHEELS & TIRES

TRACKS & PLOWES

LIGHTING

HUNT & COOLERS

41

40

WHEELS



A 4201 (AMPLIFY) ○

FRONT WEIGHT: 13 lbs | LOAD RATING: 900 lbs | OFFSET: +4
REAR WEIGHT: 14 lbs | LOAD RATING: 1300 lbs | OFFSET: -9

ACCENT: FRONT 14" x 7" 1522956-266 \$189⁹⁹
REAR 14" x 8" 1522957-266 \$209⁹⁹
MATTE BLACK: FRONT 14" x 7" 1522956-458 \$169⁹⁹
REAR 14" x 8" 1522957-458 \$179⁹⁹

B 4202 (BUCKLE) ○

FRONT WEIGHT: 12.75 lbs | LOAD RATING: 900 lbs | OFFSET: +4
REAR WEIGHT: 13.5 lbs | LOAD RATING: 1300 lbs | OFFSET: -9

ACCENT: FRONT 14" x 7" 1522544-266 \$189⁹⁹
REAR 14" x 8" 1522545-266 \$209⁹⁹
MATTE BLACK: FRONT 14" x 7" 1522544-458 \$169⁹⁹
REAR 14" x 8" 1522545-458 \$179⁹⁹

C 4301 BEADLOCK (COMBAT)

WEIGHT: 16 lbs | LOAD RATING: 1600 lbs | OFFSET: +38

ACCENT: FRONT/REAR 14" x 7" 1523284 \$269⁹⁹
MATTE BLACK: FRONT/REAR 14" x 7" 1523283 \$259⁹⁹

D 4203 BEADLOCK (REBLR) ○

FRONT WEIGHT: 13 lbs | LOAD RATING: 900 lbs | OFFSET: +4
REAR WEIGHT: 14.5 lbs | LOAD RATING: 1300 lbs | OFFSET: -9

MATTE BLACK: FRONT 14" x 7" 1522238-458 \$279⁹⁹
REAR 14" x 8" 1522239-458 \$279⁹⁹

E 4204 (SHACKLE) ○

FRONT WEIGHT: 13 lbs | LOAD RATING: 900 lbs | OFFSET: +4
REAR WEIGHT: 14 lbs | LOAD RATING: 1300 lbs | OFFSET: -9

ACCENT: FRONT 14" x 7" 1522546-266 \$189⁹⁹
REAR 14" x 8" 1522547-266 \$189⁹⁹
MATTE BLACK: FRONT 14" x 7" 1522546-458 \$169⁹⁹
REAR 14" x 8" 1522547-458 \$169⁹⁹

F 4205 (SIXR) ○

FRONT WEIGHT: 10.5 lbs | LOAD RATING: 900 lbs | OFFSET: +4
REAR WEIGHT: 12.5 lbs | LOAD RATING: 1300 lbs | OFFSET: -9

MATTE BLACK: FRONT 14" x 7" 1521507-521 \$149⁹⁹
REAR 14" x 8" 1521508-521 \$169⁹⁹
LUSTER: FRONT 14" x 7" 1521507-410 \$189⁹⁹
REAR 14" x 8" 1521508-410 \$199⁹⁹

G 4206 (SPLIT) ○

FRONT WEIGHT: 9.5 lbs | LOAD RATING: 900 lbs | OFFSET: +4
REAR WEIGHT: 10.75 lbs | LOAD RATING: 1300 lbs | OFFSET: -9

MATTE BLACK: FRONT 14" x 6" 1522542-458 \$169⁹⁹
REAR 14" x 8" 1522543-458 \$179⁹⁹

H 4101 (WHITEOUT) ○

WEIGHT: 14.5 lbs | LOAD RATING: 800 lbs | OFFSET: -35

MATTE BLACK: FRONT/REAR 14" x 10" 1522958 \$229⁹⁹

I HD DUAL BEADLOCK ○

WEIGHT: 40 lbs | LOAD RATING: 1,600 lbs | OFFSET: +38

MATTE BLACK: FRONT/REAR 14" x 7" 1524022-458 \$359⁹⁹

KNOW YOUR TERRAIN



• Tread patterns optimized for extreme traction
• Ideal for both hard pack and loose trail



• Extra deep treads
• Self-cleaning lugs



• Industry leading anti-puncture side walls
• Purpose-built, long lasting tread patterns



• Handles extreme cold
• Holds shape and provides traction

WHEEL & TIRE SETS

	TRAIL	MUD	UTILITY	SNOW
40-SERIES	ATTACK 26"	DUAL-THREAT 26"	MUD XC 27"	PRESERVE 27"
				HARVESTER 27"
				WHITEOUT 27"
○ 4201 (AMPLIFY) Accent	2882390 \$1,489 ⁹⁹	2883138 \$1,669 ⁹⁹	2884272 \$1,739 ⁹⁹	2883208 \$1,599 ⁹⁹
○ 4201 (AMPLIFY) Matte Black	2882391 \$1,359 ⁹⁹	2883139 \$1,539 ⁹⁹	2884273 \$1,612 ⁹⁹	2883209 \$1,599 ⁹⁹
○ 4202 (BUCKLE) Accent	2881335 \$1,599 ⁹⁹	2883140 \$1,699 ⁹⁹	2884267 \$1,739 ⁹⁹	2883203 \$1,739 ⁹⁹
○ 4202 (BUCKLE) Matte Black	2881336 \$1,479 ⁹⁹	2883141 \$1,539 ⁹⁹	2884268 \$1,612 ⁹⁹	2883204 \$1,599 ⁹⁹
4301 (COMBAT) Accent BEADLOCKS PRE-MOUNTED		2883217 \$2,059 ⁹⁹		
4301 (COMBAT) Matte Black BEADLOCKS PRE-MOUNTED		2883216 \$1,939 ⁹⁹		
○ 4203 (REBLR) Matte Black BEADLOCKS SOLD SEPARATELY	2881381 \$1,669 ⁹⁹			
○ 4204 (SHACKLE) Accent	2881347 \$1,599 ⁹⁹	2883142 \$1,699 ⁹⁹	2884270 \$1,739 ⁹⁹	2883205 \$1,739 ⁹⁹
○ 4204 (SHACKLE) Matte Black	2881348 \$1,479 ⁹⁹	2883143 \$1,539 ⁹⁹	2884271 \$1,612 ⁹⁹	2883206 \$1,599 ⁹⁹
○ 4205 (SIXR) Luster	2881359 \$1,599 ⁹⁹	2883144 \$1,539 ⁹⁹		
○ 4205 (SIXR) Matte Black	2881360 \$1,479 ⁹⁹	2883145 \$1,539 ⁹⁹	2884269 \$1,599 ⁹⁹	2883207 \$1,599 ⁹⁹
○ 4206 (SPLIT) Matte Black	2881404 \$1,479 ⁹⁹			
○ 4101 (WHITEOUT) Matte Black				2882382 \$2,399 ⁹⁹

LUG NUTS

○ LUG NUTS REQUIRED



METRIC LUG NUTS FOR ALUMINUM RIMS

» 2877385 - SET OF 4 • \$18⁹⁹
» 2877384 - SET OF 16 • \$43⁹⁹ SPORTSMAN XP

SAE LUG NUTS FOR ALUMINUM RIMS

» 2876754 - SET OF 4 • \$18⁹⁹
» 2877409 - SET OF 16 • \$43⁹⁹ SPORTSMAN 450/570

REPLACEMENT CAPS

CENTER CAP

LUSTER	ALL WHEELS EXCEPT 4204 (WYDE) & 4203 (HEXLR)	1521509-410 • \$15 ⁹⁹
MATTE BLACK		1521509-521 • \$15 ⁹⁹
HD MATTE BLACK	ALL WHEELS	5457498-458 • \$29 ⁹⁹

PRO ARMOR CENTER CAP

LUSTER	ALL WHEELS EXCEPT 4204 (WYDE) & 4203 (HEXLR)	5453209-410 • \$15 ⁹⁹
MATTE BLACK		5453209-458 • \$15 ⁹⁹

TIRE SEALANT P. 65

» 32 OZ. • 2830484 • \$25⁹⁹
» 1 GALLON • 2830485 • \$89⁹⁹
» 5 GALLON • 2830486 • \$364⁹⁹
» 5 GALLON PUMP • 2830487 • \$163⁹⁹

COLBY VALVE SHORT ULTIMATE VALVE - 2 PACK

» 2883292 • \$38⁹⁹

COLBY VALVE EMERGENCY VALVE - 2 PACK

» 2883293 • \$38⁹⁹

COLBY COMBO VALVE KIT (16 PACK)

• Includes 8 Ultimate valves and 8 Emergency valves

» 2883294 • \$589⁹⁹

KNOW YOUR WHEELS

STEP 1: SELECT SERIES

4 = 40-SERIES

STEP 2: CHOOSE LOAD RATING

1 = <800 LBS
2 = 801 - 1,300 LBS
3 = 1,301 - 1,600+ LBS

STEP 3: PICK STYLE

OFFSET / BEADLOCK / COLOR

INCREASE OFFSET FROM STOCK - NARROWER STANCE
DECREASE OFFSET FROM STOCK - WIDER STANCE

2 WAYS TO PURCHASE

INDIVIDUAL WHEELS & TIRES
-OR-
COMPLETE SETS AS LISTED

VISIT Polaris.com/ProArmorSPORTSMAN
TO BUILD YOUR CUSTOM SET AND VERIFY FITMENT

Exclusively at Polaris Authorized Dealers or Polaris.com/ProArmorSPORTSMAN

14" FORGED BEADLOCK RINGS

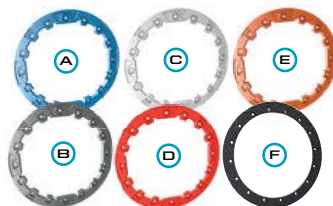

PRO ARMOR FORGED RINGS Sold individually

Only used on 4203 (REBLR)

	PART #	
A	1522244-619	\$114 ⁹⁹
B	1522244-266	\$114 ⁹⁹
C	1522244-133	\$114 ⁹⁹
D	1522244-293	\$114 ⁹⁹
E	1522244-589	\$114 ⁹⁹
F	1523146-458	\$74 ⁹⁹

Only used on 4301 (Combat)

COMMON

WITCHES

450-570

850-XP1000-XP1000S

SCRAMBLER 850-XP1000S

MISC & YOUTH

WHEELS & TIRES

TRACKS & PLOWS

LIGHTING

HUNT & COOLERS

43

42

ALL-TERRAIN TRACTION

It's tough to make Sportsman even more versatile than it already is. But with a set of Prospector Pro® Tracks, you'll do just that. Tread through deep snow without concern.

Polaris-specific gearing provides 1:1 ratio to:

- Minimize track slip, providing better climbing ability and improved traction in deep snow
- Improve top speed over prior models by approximately 5%
- Reduce operating RPM for a quieter ride
- Improve driveline durability, which allows vehicle to run at a lower RPM, decreasing engine wear

Polaris exclusive optimized hub geometry that minimizes feedback and eases steering effort

Lightweight design provides for better flotation, eases steering effort, and provides better vehicle control

Flexible lug design provides the highest level of deep snow performance by lifting up in deep snow as opposed to digging down



PROSPECTOR PRO
TRACK SYSTEM

STEP 1: SELECT A MOUNT KIT

MODELS	A ARMS	MOUNT KIT
SPORTSMAN XP 1000/850 (15-21) SPORTSMAN TOURING XP 1000/850 (15-21)	STRAIGHT	2879457 \$569 ⁹⁹
SPORTSMAN XP 1000/850 (16-21) HIGHLIFTER 1000/850 (16-21)	ARCHED	2882109 \$569 ⁹⁹
SPORTSMAN XP 1000 S (20-21) SCRAMBLER XP 1000 S (20-21)	ARCHED	2883977 \$569 ⁹⁹
SPORTSMAN 570 (21)	ARCHED	NEW 2889218 \$569 ⁹⁹
SPORTSMAN 570 (21)	STRAIGHT	NEW 2889219 \$569 ⁹⁹
SPORTSMAN 570 (15-20) SPORTSMAN TOURING 570 (15-21) SPORTSMAN X2 (15-21)	STRAIGHT	2879497 \$569 ⁹⁹

STEP 2: SELECT A TRACK KIT

MODELS	EPS	TRACK KIT
SPORTSMAN 570 (15-21) SPORTSMAN TOURING 570 (15-21) SPORTSMAN X2 (15-21)	YES	2881025 \$5,419 ⁹⁹
SPORTSMAN XP 1000/850 (15-21) SPORTSMAN TOURING XP 1000/850 (17-21) HIGHLIFTER 1000 (16-21) SPORTSMAN XP 1000 S (20-21) SCRAMBLER XP 1000 S (20-21)	YES	2881003 \$5,419 ⁹⁹
SPORTSMAN 570 (14-21) SPORTSMAN TOURING 570 (15-21)	NO	2880020 \$5,419 ⁹⁹
SPORTSMAN XP 1000 (18-21) SPORTSMAN 850 (15-21) SCRAMBLER 850 (13-21)	NO	2879720 \$5,419 ⁹⁹

TRACK AND MOUNT KIT

MODELS	EPS	TRACK AND MOUNT KIT
SPORTSMAN 570 6X6 (17-21)	YES	2882169 \$7,739 ⁹⁹

WANT TO PLOW?

GLACIER® PRO PLOW TRACK EXTENSION



- Plow extension for use when using the Prospector Pro® Track System and Glacier® Pro Sportsman plow system
- » 2879719 • \$249⁹⁹
FOR USE WITH GLACIER® PRO PLOW SYSTEMS



WANT TO PLOW? SEE P. 46

SPORTSMAN SNOW TRACTION OPTIONS

TREAD THROUGH SNOW WITH THESE OPTIONS	CONTACT PATCH	TURNING RADIUS
 <p>STOCK TIRES</p>	<p>GOOD</p> 	<p>139.5"</p> 
 <p>PRO ARMOR WHITEOUT</p>	<p>BETTER</p>  <p>MORE SURFACE AREA FOR BETTER FLOTATION ON SNOW</p>	<p>138.875"</p> 
 <p>PROSPECTOR PRO® TRACKS</p>	<p>BEST</p>  <p>LESS AGGRESSIVE TREAD DISPLACES SNOW FOR BETTER HANDLING</p>	<p>175.375"</p> 

GLACIER[®]

PLOW SYSTEM

TAKE COMMAND OF CLEARING SNOW AND MAKE QUICK WORK OF EVEN THE HEAVIEST JOBS.



BUILD YOUR PERFECT PLOW SYSTEM



ADD HYDRAULICS



CONTROL FROM THE PALM OF YOUR HAND

Change the angle of the plow blade with the Power Controller.



HYDRAULIC CONTROL FOR EXTREME SNOW REMOVAL

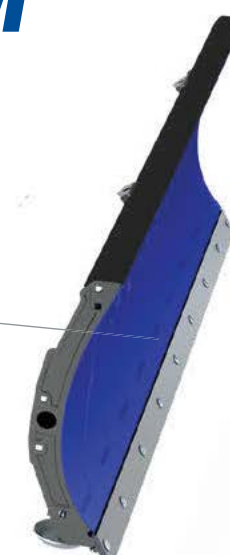

GLACIER[®] PRO HD GIVES YOU

» 66", 60" or 52" Blades

» Choice of poly or steel

» Ability to add a hydraulic angle system

THE POLARIS ENGINEERED ADVANTAGE

INSTALLATION

30 seconds: Drive up, clip in, lock down, and go – the integrated Polaris Engineered Glacier[®] Plow System simplifies plowing.



CONVENIENCE

Lift and angle adjustments can be made from the driver's seat.

ANGLE YOUR BLADE RIGHT FROM YOUR SEAT WITH THE GLACIER[®] PRO PLOW HYDRAULIC ANGLE SYSTEM



ROBUST FRAME

A plow system is only as strong as its frame, and Polaris Engineered plow frames have a wide frame to withstand the rigors of heavy plowing.



DURABLE BLADES

Available in strong stamped steel or corrosion-resistant poly materials, Polaris Engineered plow blades cover a large surface area for quick snow removal.

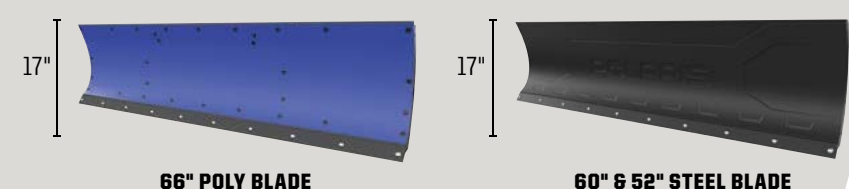

66" POLY BLADE

60" & 52" STEEL BLADE

MODELS	MANDATORY STEPS				OPTIONAL
	STEP 1 SELECT A MOUNT	STEP 2 SELECT A FRAME	STEP 3 SELECT PLOW CONFIGURATION		STEP 4 ADD HYDRAULICS
	MOUNT	FRAME	WINCHES	BLADES	HYDRAULICS
XP 1000 '15-21 850 '15-21, 850 SP '15-19 850/XP 1000 HIGHLIFTER '16-21 TOURING XP 1000 '15-21 TOURING 850 SP '15-19 TOURING 850 '10-21 SCRAMBLER 850 '14-21	2881423 \$229 ⁹⁹		Polaris Pro HD 3,500 lb. Winch 2882241 \$699 ⁹⁹ Polaris HD 3,500 lb. Winch 2880435 \$609 ⁹⁹ Polaris HD 2,500 lb. Winch 2880433 \$509 ⁹⁹		
XP 1000 S '20-21 SCRAMBLER XP 1000 S '20-21	2883581 \$234 ⁹⁹		Polaris PRO HD 3,500 lb. Winch 2883580 \$709 ⁹⁹		
570 SP '15-19 570 '15-20 6X6 570 '17-21 X2 570 '15-21 TOURING 570 SP '15-19 TOURING 570 '14-21 450 H.O. '12-20		2879630 \$339 ⁹⁹	Polaris HD 3,500 lb. Winch 2880434 \$609 ⁹⁹ Polaris HD 2,500 lb. Winch 2880432 \$509 ⁹⁹	66" Poly 2880269 \$539 ⁹⁹ 60" Steel 2879638 \$339 ⁹⁹ 52" Steel 2879639 \$279 ⁹⁹	Hydraulic Plow Blade Angle System 2879635 \$739 ⁹⁹ Power Controller 2880836 \$134 ⁹⁹ Power Controller Recommended
450 H.O. '21 570 '21		2881424 \$229 ⁹⁹	Polaris Pro HD 3,500 lb. Winch 2884834 \$709 ⁹⁹ Polaris HD 3,500 lb. Winch 2884833 \$599 ⁹⁹ Polaris HD 2,500 lb. Winch 2884832 \$519 ⁹⁹		

STEP 5 SELECT ACCESSORIES & REPLACEMENT ITEMS

ACCESSORIES & REPLACEMENT ITEMS		
66" HD Wear Bar 2879868 \$134 ⁹⁹ 66" Wear Bar 2879867 \$74 ⁹⁹ 60" Wear Bar 2877243 \$48 ⁹⁹ 52" Wear Bar 2877210 \$54 ⁹⁹	66" Plow Blade Snow Deflector 2879866 \$114 ⁹⁹ 60" Plow Blade Deflector 2871808 \$89 ⁹⁹ Skid Shoe 2205071 \$36 ⁹⁹ Glacier[®] Pro Shear Pin Replacement 2205063 \$17 ⁹⁹	Plow Winch Rope For 2,500 lb. & 3,500 lb. winches 2878483 \$38 ⁹⁹ Glacier[®] Plow Marker Sold in pairs 2872726 \$43 ⁹⁹ Rear Tire Chains Recommended for rear tires only 2881422 \$129 ⁹⁹ Plow Blade Track Extension Required for track equipped vehicles 2879719 \$249 ⁹⁹

NEED TRACKS? SEE P. 44

COMMON
WINCHES
450-570
850-XP1000-XP1000S
SCRAMBLER 850-XP1000S
MISC & YOUTH
WHEELS & TIRES
TRACKS & PLOW
LIGHTING
HUNT & COOLERS



POLARIS ENGINEERED ADVANTAGES

MOUNTS PERFECTLY
Designed for your Polaris Engineered bumper, roof or other mounting point

MAX PERFORMANCE
Validated to work as hard as your machine does

DOESN'T OVERTAX
Trust it to work when you need it to



ADVANCED TECH

RIGID® lights are driven by Aluminum PCB Smart Boards™, 6063-T5 aircraft aluminum extruded housings and Tiger Drylac® UV protection polyester powdercoating.

EXCLUSIVE OPTICS

RIGID® lights feature impact-resistant polycarbonate lenses for a 100% water/dustproof seal.

RIGID® LIMITED LIFETIME WARRANTY

If you own a RIGID® light and it breaks, we will replace or repair it for life.*

RUGGED CONSTRUCTION

Pro Armor lights are designed to be big and beefy with an aggressive style all their own, and housed in IP67 marine-grade rated UV polyester powdercoating.

MASSIVELY BRIGHT

Pro Armor builds bright lights designed for any riding experience. All that power is directed through heat dissipating aluminum for streamlined heat management.

LIGHT BAR TYPES



SR-SERIES PRO

Sleek, powerful, low-profile (under 2" tall). Lights extreme distances with low energy usage.
Available in 10"



D-SERIES PRO

Compact to fit almost anywhere with high output and low energy usage.
Available in Driving, Flood & Spot



SEE THE RIGID® LIGHTING BUYERS GUIDE ON THE POLARIS YOUTUBE CHANNEL Search "RIGID"



DUAL-ROW LED LIGHT BARS

The most spread and farthest illumination downrange. Easy to mount.
Available in Cube, 10" & 20"



SINGLE-ROW LED LIGHT BARS

Powerful, compact, low-profile light bars with a sleek look.
Available in 11" & 20"



CUBE LED LIGHTS

Small size allows mounting in strategic locations for added lighting.
Available in Flood & Spot

LIGHT BAR OPTIONS

SHOP & VERIFY VEHICLE FITMENT AT POLARIS.COM/ShopSPORTSMAN

OPTICS DRIVING

FLOOD

SPOT

COMBO

OPTICS

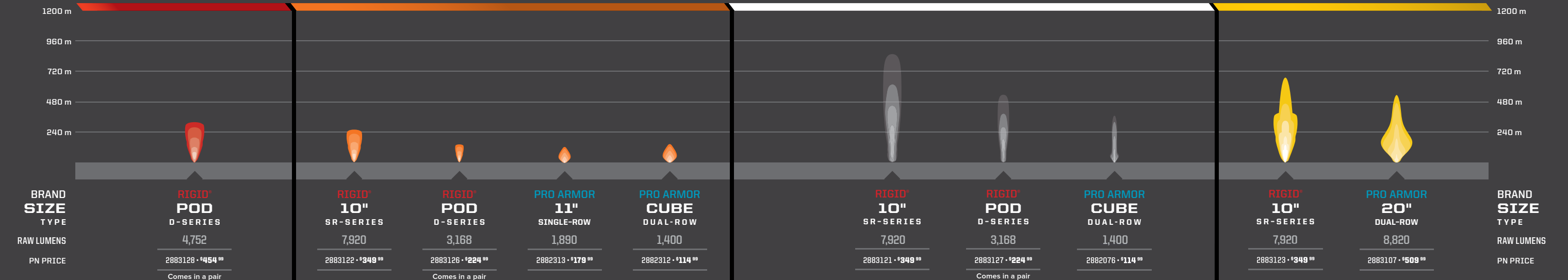

BUILD YOUR VISION

Consider the Optics, Angle & how you will use your vehicle to choose the right light or set of lights.

OPTICS LIGHT ANGLE	ACCENT	DRIVING (45°)	FLOOD (25°)	SPOT (10°)	COMBO (25°/10°)
DRIVING SPEED	All	Slow	Medium	Fast	Medium to fast
BEAM	Diffused glow	Extra-wide	Wide/Shorter	Concentrated/Long	Inner spot & outer flood
RECOMMENDED MOUNTING	Low/Wheel well	All points	Low &/or rear	High points	All points
TERRAIN & RIDING STYLE	Added style & personalization in any terrain	All riding & utility	Wide-open terrain or trails & utility	Trail & tight conditions	All riding & utility

COMPARE LIGHTS IN A REAL WORLD SETTING AT POLARIS.COM/LIGHTING

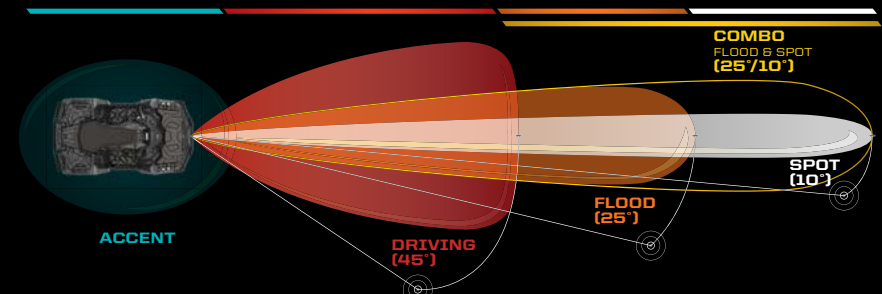

LED LIGHTING

NEW LED LIGHT KIT

- Upgrade your standard headlights and pod lights to LEDs with this upgrade kit
- 2884859 • \$519⁹⁹
- XP 1000 '21, 850 '21, 570 '21, 450 H.O '21

ACCENT LIGHTING

ACCENT LIGHT KIT

- Durable off-road ready construction that is both dust- and water-resistant
- Features CREE® LED for a long-lasting, brilliant light
- Set includes four LED pods

COLOR	LIGHTING KIT
RED	2880500 • \$209 ⁹⁹
BLUE	2880506 • \$209 ⁹⁹

WIRING HARNESSES

LIGHTBAR HARNESS

- Control one light with one switch
- 2882320 • \$74⁹⁹
- ALL SPORTSMAN MODELS

LED Y-HARNESS

- Y-Harness requires 2882320 to control two cubes or two lights with one switch
- 2879860 • \$23⁹⁹
- ALL SPORTSMAN MODELS

* If RIGID® determines, in its sole discretion, that your product is defective in material or workmanship, RIGID® will honor your warranty claim. In some cases the product will be replaced, depending on the specific timeframe of the purchase. If the product is repaired, all parts, labor, and return shipping may be covered by RIGID®.

COMMON

WITCHES

450-570

850-XP1000-XP1000S

SCRAMBLER 850-XP1000S

MISC & YOUTH

WHEELS & TIRES

TRACKS & PLOW

LIGHTING

HUNT & COOLERS

PROTECTING YOUR ESSENTIAL GEAR SINCE 1943

KOLPIN STRONGHOLD SYSTEM

Polaris is proud to partner with Kolpin Outdoors, an industry leader in off-road accessories and the premier name in gun boots and mounts. If you need to secure a firearm while riding, simply attach the auto-latch mount and choose your case.

IDEAL FOR SECURE TRANSPORT OF SCOPED RIFLES AND SHOTGUNS

STEP 1 CHOOSE YOUR MOUNT



AUTO-LATCH BOOT MOUNT

- Precision angle adjustable for a custom fit
- Provides a quick and secure attachment point

» 2882272 • \$94⁹⁹
XP 1000 S '20-21, XP 1000 '17-21, 850 '17-21
Does not fit with bodyguard Brushguard (2882090)

NEW GUN BOOT MOUNT

- The Auto-latching design provides quick and secure Kolpin Stronghold product attachment
- Bracket is made from rugged high impact, reinforced nylon and coated steel with precision angle adjustment for a custom fit
- For use with the Kolpin Stronghold line of products (sold separately)

» 2884846 • \$94⁹⁹
570 '21, 450 H.O. '21

STEP 2 CHOOSE YOUR BOOTS



GUN BOOT XL

- Lockable and TSA Approved
- Includes zippered internal liner
- 52" L x 3 3/4" W x 10 1/2" H

» 2882430 • \$109⁹⁹
XP 1000 S '20-21, XP 1000 '17-21, 850 '17-21, 570 '19-21, 450 H.O. '21
Requires Auto-Latch Mount to mount to vehicle (2882272 or 2884846)

GUN BOOT L

- 52" L x 4 3/4" W x 9 3/4" H

» 2882426 • \$83⁹⁹
XP 1000 S '20-21, XP 1000 '17-21, 850 '17-21, 570 '14-21, 450 H.O. '19-21
Requires Auto-Latch Mount to mount to vehicle (2882272 or 2884846)



KOLPIN RHINO GRIP

IDEAL FOR CARRYING RIFLES, SHOTGUNS, BOWS AND CROSSBOWS.



LOCK & RIDE RHINO GRIP PRO

- » 2884119 • \$109⁹⁹
 - » 2884109 • REPLACEMENT RUBBER STRAPS • \$11⁹⁹
- ALL SPORTSMAN MODELS (EXCEPT UTILITY EDITIONS & YOUTH)



LOCK & RIDE RATCHETING RHINO GRIP

- » 2881157 • \$83⁹⁹
- XP 1000 '15-21, X2 570 '15-21, TOURING XP 1000 '15-21, TOURING 850 '10-20, TOURING 570 '14-21, 850 '09-21, 6X6 570 '17-21, 570 '14-21, 450 H.O. '12-21



NEW LOCK & RIDE RHINO GRIP XLR

- » 2889147 • \$55⁹⁹
 - » 2889204 • RHINO GRIP XLR REPLACEMENT RUBBER STRAPS (2) • \$11⁹⁹
- ALL SPORTSMAN MODELS (EXCEPT UTILITY EDITIONS & YOUTH)



NEW LOCK & RIDE RHINO GRIP XLR - DOUBLES

- » 2889148 • \$90⁹⁹
 - » 2889204 • RHINO GRIP XLR REPLACEMENT RUBBER STRAPS (2) • \$11⁹⁹
- ALL SPORTSMAN MODELS (EXCEPT UTILITY EDITIONS & YOUTH)



RHINO GRIP PRO REPLACEMENT RUBBER STRAPS (2)

- » 2884109 • \$11⁹⁹
- ALL SPORTSMAN MODELS (EXCEPT UTILITY EDITIONS & YOUTH)



KOLPIN GUN BOOT IV

- For 50mm scopes, rifles with slings attached, or shotguns up to 51" in length
- » BLACK • 2872677 • \$83⁹⁹

LOCK & RIDE GUN BOOT MOUNTS

- High-impact case secures firearm over any terrain
- Works with Lock & Ride XL Storage Box, Lock & Ride Rear Cargo Box, and Rear Rack Extenders

» 2878001 • \$169⁹⁹
TOURING XP 1000 '15-21, TOURING 850 '10-20, TOURING 570 '21
Only Compatible With Kolpin Gun Boot IV - Not Compatible with Kolpin Stronghold Gun Boots

**KEEP IT
ICE COLD**



**GRIZZLY TESTED.
POLARIS APPROVED.**



This cooler is IGBC-approved, meaning it withstands the power expended by a typical grizzly bear if it was trying to get inside.

Seriously, there are experts who know what a grizzly is capable of doing, and they certify our coolers can take it.



**30, 60 & 105
QUART FEATURES**



ComfortCarry Handles



TravelLock System



EasyOut Drain System



NoSlip Rubber Feet



PolarWall Insulation



IceLock Seal

POLARIS NORTHSTAR COOLERS CAN SURVIVE JUST ABOUT ANYTHING - FROM EXTREME HEAT TO A NASTY TUMBLE OFF A VEHICLE.



105 QUART

- » GRAPHITE • 2883426 • **\$509⁹⁹**
- » DESERT • 2883392 • **\$509⁹⁹**



60 QUART

- » GRAPHITE • 2883425 • **\$409⁹⁹**
- » DESERT • 2881259 • **\$409⁹⁹**



30 QUART

- » GRAPHITE • 2883424 • **\$309⁹⁹**
- » DESERT • 2881315 • **\$309⁹⁹**



15 QUART

- » GRAPHITE • 2883968 • **\$249⁹⁹**



20 QUART SOFTSIDED COOLER

- » GRAPHITE • 2883390 • **\$209⁹⁹**

**HOLDS ICE
30+
HOURS
LONGER
THAN YETI®***

*YETI is a registered trademark of YETI COOLERS, LLC

ESSENTIAL ACCESSORIES SO YOUR COOLER WORKS AS HARD AS YOU DO

COOLER ACCESSORIES	105 QUART	60 QUART	30 QUART	DON'T FORGET THESE ACCESSORIES	
 WIRE BASKET	2883648 • \$59⁹⁹	2882185 • \$43⁹⁹	2882438 • \$36⁹⁹	 TUMBLERS » 30 OZ • 2883394 • \$36⁹⁹ » 20 OZ • 2883393 • \$30⁹⁹	 BOTTLE OPENER » 2882183 • \$15⁹⁹ ALL COOLERS
 DIVIDERS Doubles as cutting board	2883468 • \$43⁹⁹ COMES WITH ONE DIVIDER 1 way to partition	2882184 • \$59⁹⁹ COMES WITH TWO DIVIDERS 2 ways to partition	2882186 • \$30⁹⁹ COMES WITH ONE DIVIDER 1 way to partition		
 SEAT CUSHION	NOT AVAILABLE	2882179 • \$114⁹⁹	2882507 • \$89⁹⁹		
 WHEELS	2883967 • \$119⁹⁹	2882180 • \$124⁹⁹	NOT AVAILABLE		

FOR THE LIFE OF YOUR RIDE

POLARIS ENGINEERS PARTS THAT PUSH THE LIMITS WITHOUT SACRIFICING STRENGTH AND DURABILITY. We build our products so anyone with the right tools can maintain their vehicle from their own garage - and get them back on the trails where they belong.

MAINTENANCE TIP

BREAK-IN PERIOD

The break-in period for your new Sportsman is the first 25 hours of operation, or the time it takes to use the first two tanks of fuel. No single action on your part is as important as a proper break-in period. Careful treatment of a new engine will result in more efficient performance and longer life for the engine.

NOTICE: Excessive heat build-up during the first three hours of operation will damage close-fitted engine parts. Do not operate at full throttle or high speeds for extended periods during the first three hours of use.

SEE OUR LATEST MAINTENANCE TIPS AT ATV.POLARIS.COM/EN-CA/SELF-HELP

BATTERIES

To ensure a battery maintains its level of charge when unused for extended periods of time or during freezing weather, the battery should be connected to a BatteryMINDER™, P. 64. Be sure to check for corrosion from the terminals to the ends of the cables.

BRAKE PADS

Maintaining and/or replacing brakes are critical to the safety and functionality of a vehicle. Brake pads should be checked for wear and oil or grease (petroleum products) contamination and brake discs should be checked for cracks, excessive corrosion or warping.

HALF SHAFT

Check for tear and punctures in the boot which can lead to CV joint wear that can contribute to axle failure.

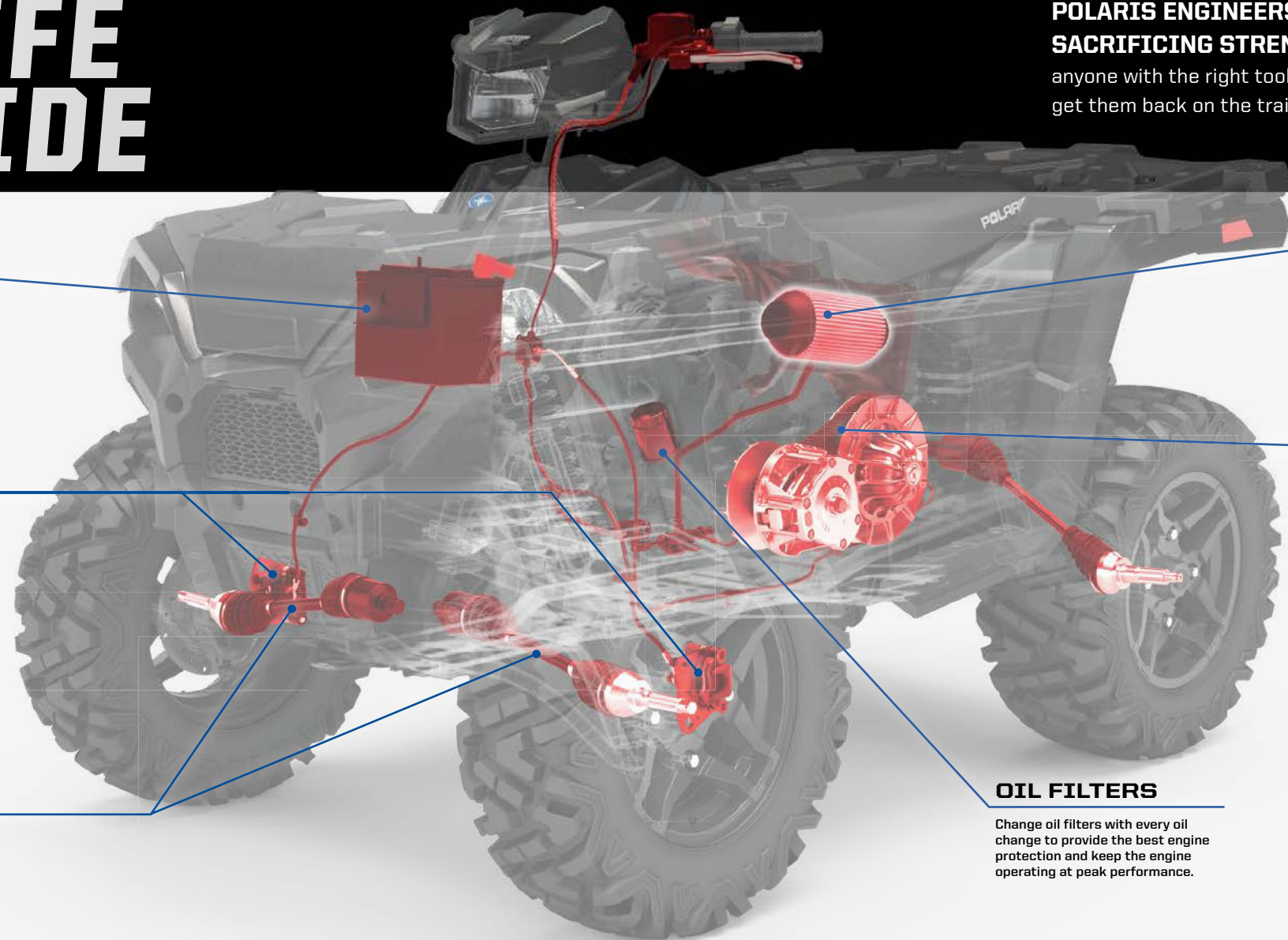

AIR FILTERS

A clogged air filter can restrict air flow to the engine leading to reduced engine performance, engine life or catastrophic failure.

DRIVE BELTS

Polaris Engineered belts deliver unmatched performance for your off-road vehicle. Developed and tested on all our engines for all environments and conditions. Check your belt for delamination, hour glassing and glazing.

BREAK-IN PERIOD

- Use lower gear (if available) while varying speeds and avoiding wide open throttle for 5-10 miles / 8-16 km
- If no low gear is available, vary at moderate speeds while avoiding wide open throttle for 50 miles / 80 km

OUR INVESTMENT

- 20,000 miles / 32,187 km of field testing
- Thousands of dyno hours
- 18+ months of development (3,000+ design hours) per belt
- 1200+ vehicle validation hours
- Collaboration with powertrain & clutch engineers

YOUR ADVANTAGE

- No clutch recalibration
- Less wear & tear due to heat
- Ensure maximum vehicle performance
- More time riding, less time wrenching
- Produced in collaboration with powertrain and clutch engineers to ensure a perfect fit, maximum performance and ultimate durability

OIL FILTERS

Change oil filters with every oil change to provide the best engine protection and keep the engine operating at peak performance.

FOLLOW RECOMMENDED SERVICE INTERVALS IN THE OWNER'S MANUAL

MAINTENANCE SCHEDULE

25 HRS / 250 Mi / 400 km

BREAK-IN MAINTENANCE

- ENGINE OIL:** CHANGE
- GENERAL LUBRICATION:** ALL FITTINGS, PIVOTS, CABLES, ETC.
- GEARCASES:** CHECK OIL LEVEL
- AIR FILTER:** INSPECT & REPLACE AS NEEDED
- EXHAUST SYSTEM:** INSPECT & CLEAN
INSPECT FOR LEAKAGE OR CARBON BUILD UP AT JOINTS
INSPECT & CLEAN SCREEN TYPE SPARK ARRESTOR

50 HRS / 500 Mi / 800 km

6 MONTHS

- EXHAUST SYSTEM:** INSPECT & CLEAN
INSPECT FOR LEAKAGE OR CARBON BUILD UP AT JOINTS
- DRIVE BELT:** INSPECT & CLEAN SCREEN TYPE SPARK ARRESTOR
- GENERAL LUBRICATION:** ALL FITTINGS, PIVOTS, CABLES, ETC.
- DRIVE BELT:** INSPECT & ADJUST
REPLACE AS NEEDED

100 HRS / 1000 Mi / 1600 km

12 MONTHS

- ENGINE OIL:** CHANGE
- DRIVE BELT:** INSPECT & ADJUST
REPLACE AS NEEDED
- EXHAUST SYSTEM:** INSPECT & CLEAN
INSPECT FOR LEAKAGE OR CARBON BUILD UP AT JOINTS
INSPECT & CLEAN SCREEN TYPE SPARK ARRESTOR

150 HRS / 1500 Mi / 2400 km

18 MONTHS

- BATTERY:** TEST, CLEAN, & CHECK FLUID LEVEL
REPLACE AS NEEDED
- DRIVE BELT:** INSPECT & ADJUST
REPLACE AS NEEDED
- TIRES:** INSPECT CONDITION & PRESSURE
- EXHAUST SYSTEM:** INSPECT & CLEAN
INSPECT FOR LEAKAGE OR CARBON BUILD UP AT JOINTS
INSPECT & CLEAN SCREEN TYPE SPARK ARRESTOR

200 HRS / 2000 Mi / 3200 km

24 MONTHS

- ENGINE OIL:** CHANGE
- TRANSMISSION FLUID:** CHANGE
- GEARCASES:** CHECK OIL LEVEL
- BRAKE PADS & FLUID:** INSPECT & CLEAN
REPLACE AS NEEDED
- SPARK PLUGS:** INSPECT
REPLACE AS NEEDED
- EXHAUST SYSTEM:** INSPECT & CLEAN
INSPECT FOR LEAKAGE OR CARBON BUILD UP AT JOINTS
INSPECT & CLEAN SCREEN TYPE SPARK ARRESTOR

250 HRS / 2500 Mi / 4023 km

30 MONTHS

- ENGINE OIL:** CHANGE
- BATTERY:** TEST, CLEAN, & CHECK FLUID LEVEL
REPLACE AS NEEDED
- DRIVE BELT:** INSPECT & ADJUST
REPLACE AS NEEDED
- GENERAL LUBRICATION:** ALL FITTINGS, PIVOTS, CABLES, ETC.
- EXHAUST SYSTEM:** INSPECT & CLEAN
INSPECT FOR LEAKAGE OR CARBON BUILD UP AT JOINTS
INSPECT & CLEAN SCREEN TYPE SPARK ARRESTOR

300 HRS / 3000 Mi / 4828 km

36 MONTHS

- ENGINE OIL:** CHANGE
- AIR FILTER:** INSPECT & REPLACE AS NEEDED
- GEARCASES:** CHECK OIL LEVEL
- EXHAUST SYSTEM:** INSPECT & CLEAN
INSPECT FOR LEAKAGE OR CARBON BUILD UP AT JOINTS
INSPECT & CLEAN SCREEN TYPE SPARK ARRESTOR

CHECK YOUR OWNER'S MANUAL FOR ADDITIONAL RECOMMENDED SERVICE ITEMS AND VEHICLE-SPECIFIC TIMING

FOR THE LIFE OF YOUR RIDE ONLY THE BEST WILL DO

To create the best oil for any terrain, we invest in rigorous testing to ensure our oil delivers the consistency and performance you demand.

WHAT COUNTS IN OIL TESTING:

1. Does it protect the engine at high temperatures?
2. Does it keep the engine free from carbon and buildup?
3. Does the oil hold its viscosity over time?

ENGINE CHECKPOINTS

Polaris engineers focus on key areas within the engine when evaluating engine oil and its ability to protect the life of your ride. Critical checkpoints include:



PISTON RINGS & RING LANDS: Extreme pressure to these parts require high lubricant film strength. Poor oxidative performance can lead to carbon and varnish buildup, which results in poor ring seal and fuel dilution of the oil. These can result in loss of power and accelerated engine wear.



ROD BEARINGS: Engine bearings on an oil with low film strength and thinner viscosity can lead to premature wear or even engine failure.



CAMSHAFT: Direct acting overhead camshafts are used on many Polaris engines. In this application the camshaft pushes directly on the valve, creating very high contact pressures compared to other camshaft configurations. These forces are so great that inferior oil can break down leading to increased wear and potential engine damage.

100 HR Polaris Endurance Dynamometer Engine Test Platform: RZR 1000 Oil Used: PS-4 5W50

**SPECIFIC NEEDS,
SPECIFIC OILS**

PS-4 FULL-SYNTHETIC OIL

PS-4 is optimal for ambient operating temperatures of -40° F to 100° F

OUR FORMULATION

- Full-synthetic formula with wide, 5W-50 viscosity range
- Extreme cold weather flow and startup protection
- Maximum rust and corrosion protection
- Proprietary anti-wear additive system

YOUR ADVANTAGE

- All-weather engine protection
- Easy starting in all conditions
- Internal engine protection from extreme temperature fluctuations and periods of non-use or storage
- Reduced friction, protects cams, pistons, bearing and valvetrain components from wear

PS-4 EXTREME-DUTY FULL-SYNTHETIC OIL

PS-4 Extreme Duty is optimal for ambient operating temperatures of 0° F to 130° F

OUR FORMULATION

- Extreme high-temperature engine protection
- Full-synthetic formula with strong, 10W-50 Viscosity Range
- Protects against rust and corrosion of internal engine parts during periods of non-use or storage

YOUR ADVANTAGE

- High-strength film protection withstands extreme heat, stress and sustained high RPM conditions
- Extremely shear stable, maintains viscosity under heat and stress
- Protects engine from moisture that can build up inside the engine as a result of extreme temperature fluctuations

OIL CHANGE KITS

These convenient kits include everything you need to change your oil. The correct filter and oil volume for your vehicle.

PS-4	PS-4 EXTREME DUTY	
PART NUMBER	VEHICLE FITMENT	PART NUMBER
2202166	RANGER/RZR/SPORTSMAN 570, TWIN 600, TWIN 700, TWIN 800	2879004
2879323	RANGER, POLARIS GENERAL, RZR 900/1000, RS1	2879324
2877473	RANGER/ SPORTSMAN 300-500, SPORTSMAN/SCRAMBLER 500/850/1000	2878924
2881696	RZR TURBO	2881697

- » 1 Quart 2876244
- » 1 Gallon 2876245
- » 16 Gallons 2876247
- » 55 Gallon Drum 2876246
- » 330 Gallon Tote 2878814

- » 1 Quart 2878920
- » 1 Gallon 2878919
- » 16 Gallons 2879003
- » 55 Gallon Drum 2879002
- » 330 Gallon Tote 2879001

SUPERIOR ENGINE PROTECTION

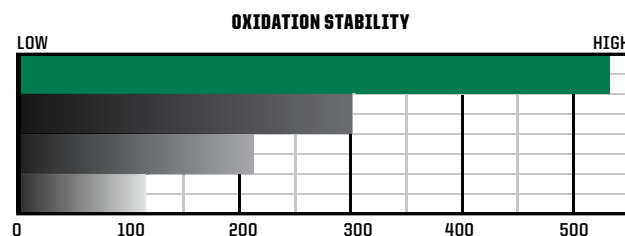

Higher Number = Longer Oil Life
Polaris proprietary additive system resists the negative effects of oil oxidation longer than leading aftermarket and automotive engine oils.

CLEAN ENGINE, LOWER DEPOSITS

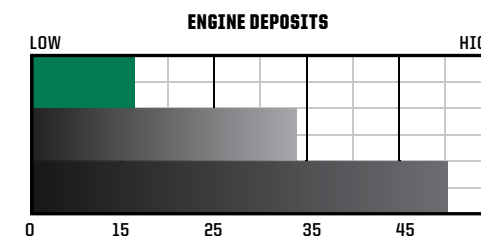

Clean Engine Test
Lower Number = Less Deposits, Cleaner Engine Operates at Peak Performance.
ASTM Test D6335

OIL DEVELOPMENT

POLARIS INVESTS IN EACH OIL AT AND ABOVE THESE LEVELS.

POLARIS.COM/ShopSPORTSMAN

12 DEDICATED TEAM MEMBERS

FOCUSED ON POLARIS OIL

18+ MONTHS

DEVELOPMENT & TESTING

75,000+ HOURS

DYNO TESTING

64,374 KILOMETERS

FIELD TESTING (1.8 MILLION MILES)

MAINTENANCE FLUIDS



DOT 4 BRAKE FLUID

A high-quality brake fluid designed for use in Polaris hydraulic brakes.

Change every 200 hours, 2000 miles / 3200 km or every 24 months.

» 12 OZ. • 2872189



AGL

Protect gears, drive chain, and bearings from scoring and wear.

Change every 200 hours, 24 months or 2000 miles / 3218 km.

» 1 QT. • 2878068
» 1 GAL. • 2878069
» 2.5 GAL. • 2878070
» 55 GAL. • 2879594

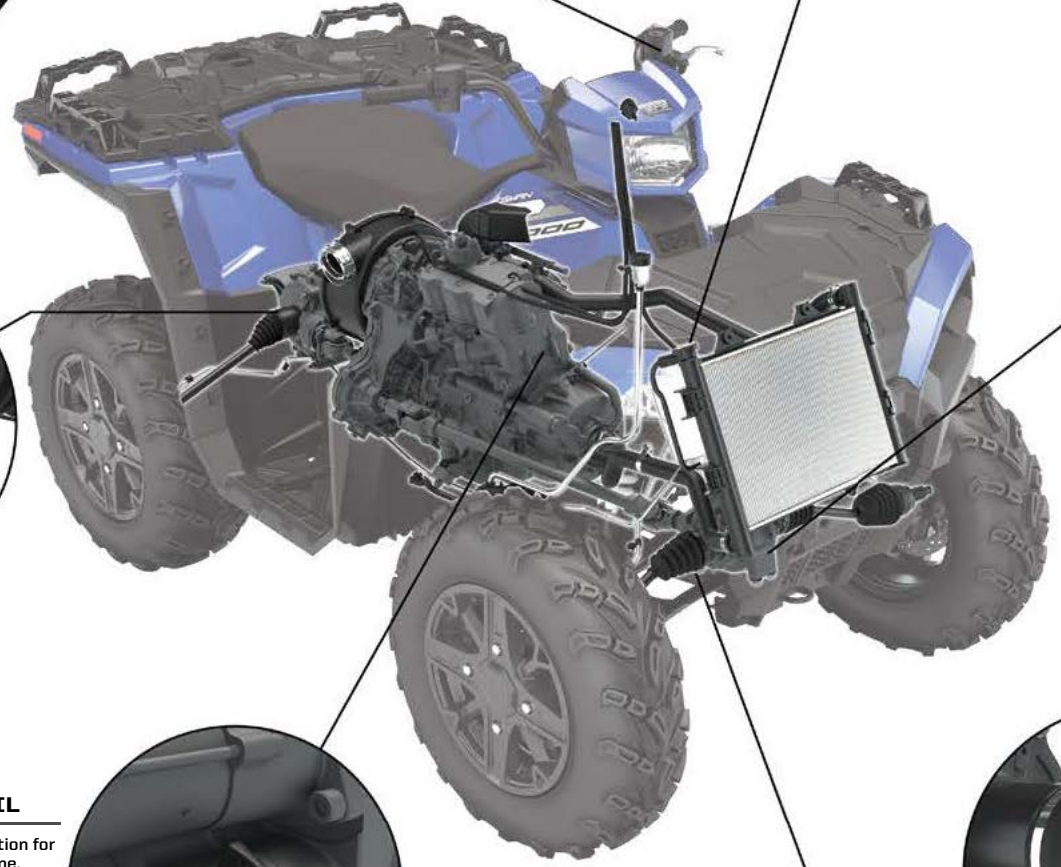

ORV MAINTENANCE KIT

- Everything you need, in the correct fluid volumes, to maintain your drive train, and keep your vehicle in top operating condition
- Includes: 1.5 qts. AGL, 1 qt. Angle Drive Fluid, 1 pint Demand Drive Fluid, 1-3 oz. tube of All-Season Grease

» 2880425



ENGINE OIL

Maximum protection for your 4-cycle engine.

Change every 100 hours, 1000 miles / 1600 km or 12 months.



ANTI-FREEZE

Prevent corrosion on metal components, eliminate scaling, and maximize cooling system performance.

Change every 60 months.

» 1 QT. • 2880514
» 1 GAL. • 2880513
» 55 GAL. • 2880512



DEMAND DRIVE FLUID

Provide positive 4WD engagement in extreme cold or high head conditions and protect internal components under heavy loads.

Change every 100 hours or every 36 months.

» 1 QT. • 2877922
» 2.5 GAL. • 2877923



SUSPENSION/ U-JOINT GREASE

A heavy-duty lubricant formulated with molybdenum disulfide to accept the high shock applications of Polaris ATV shaft drive universal joints.

Add every 50 hours, 3 months or 500 miles / 800 km.

» 3 OZ. • 2871515
» 14 OZ. • 2871551



LUBRICANT ACCESSORIES

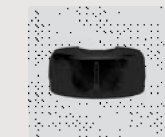

NEW OIL FILTER WRENCH

- Remove Polaris ORV oil filters with ease.

» 2830550 • \$10⁹⁹



NEW FLUID FUNNEL

- Easily add oil with high accuracy.

» 2830552 • \$17⁹⁹

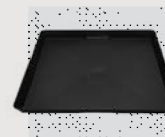

NEW FLUID TRAY

- Holds up to 8 quarts of fluid.

» 2830551 • \$26⁹⁹

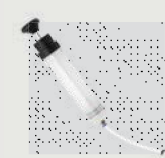

NEW FLUID SYRINGE

- Easily add and remove fluid from your vehicle.

» 2830553 • \$39⁹⁹

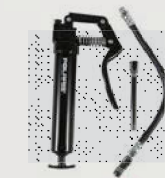

GREASE GUN

- Enables easy application of grease.

» 2871312 • \$44⁹⁹

FITS 2871322 ALL-SEASON AND 2871515 U-JOINT 3 OZ.



2D BATTERY-OPERATED SIPHON PUMP

- Liquid transfer pumps 5-6 quarts/min suctioning power.

» 2830513 • \$20⁷⁹

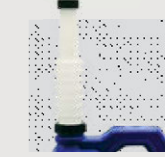

FLEX SPOUT

- Fits all Polaris quart, gallon and 2.5 gallon bottles.

» 2871285 • \$3⁹⁹



PUMP

- Fits 1 and 2.5 gallon bottles.

» 2870465 • \$9⁹⁹



PREMIUM GAS SHOCK OIL

- Specialized shear stable blend containing high levels of anti-wear anti-foam & oxidation

» 1 QT. • 2870995
» 2.5 GAL. • 2872279

FOX® REBUILDABLE SHOCKS



10WT GAS SHOCK OIL

- Specialized fluid to ensure proper gas shock absorber action

» 1 QT. • 2874124

WALKER EVANS® REBUILDABLE SHOCKS



CHAIN LUBRICANT

- Provides superior anti-wear and shock protection

» 16 OZ. AEROSOL 2872348



ALL-SEASON GREASE TUBE

- Specialized water resistant lubricant

» 3 OZ. • 2871322
» 14 OZ. • 2871423



ANGLE DRIVE FLUID

- Extreme pressure, anti-wear and high viscosity film lubrication for maximum protection

» 1 QT. • 2876160
» 2.5 GAL. • 2872276

SPORTSMAN, RANGER, RZR ANGLE DRIVE GEAR CASE SYSTEMS



GENERATOR OIL

- 4-Cycle Engine Oil

» 1 QT. • 2879383



CARBON CLEAN

- Ultimate fuel and injection system cleaner

» 12 OZ. • 2881413



ADVANCED FUEL TREATMENT

- Dual Antioxidant formula protects jets and fuel system from gum and varnish

» 12 OZ. • 2881416
» 2.5 GAL. • 2881417

SERVICE PARTS

Polaris Engineered service parts deliver unmatched performance and fit for your off-road vehicle.

All service parts are engineered specifically for your machine. Which means everything is designed, tested and perfected to maximize the life of your ride. Getting Polaris Engineered parts is a decision that pays off in the long run, because it ensures there is a long run.



SHOP FOR SERVICE PARTS ONLINE OR VISIT YOUR POLARIS DEALER.

CHECK OUT OUR PARTS FINDER ON POLARIS.COM FOR EASY PARTS LOOK-UP, PARTS IDENTIFICATION, VIEWS OF ASSEMBLIES & MORE!

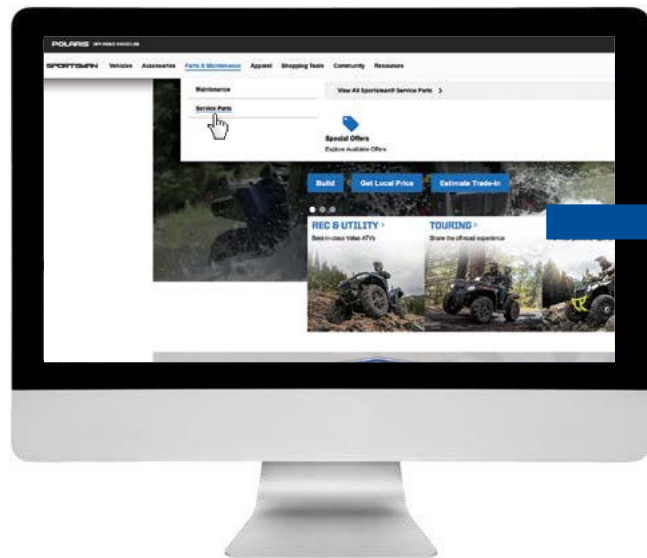

STEP 1

Visit [Polaris.com/SPORTSMAN](https://www.polaris.com/SPORTSMAN)
Click "Parts & Service" tab
Click "Service Parts"

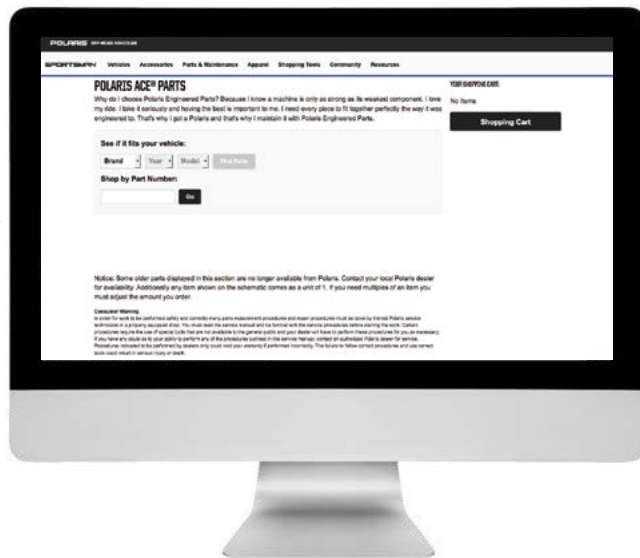

STEP 2

Enter **vehicle year/model** or shop by **part number**



STEP 3

Clearly see what parts are required and **order**

Assembly
DRIVE TRAIN, FRONT HALF SHAFT - A17DAA50A7 (100044)

A17DAA50A7 ACE 500 60HC (2017) (R14)

Tag	Part #	Description	Price	Qty	
1	1333246	ASM-SHAFT,HALF,FRONT	\$249.99	2	Add
2	2205801	K-JOINT,CV [INCL. BALL, INTER RACE, CAGE, BELL]	\$74.99	1	Add
3	2205802	K-BOOT,OUTER [INCL. CLAMPS, BOOT, GREASE]	\$49.49	1	Add
4	2205803	K-HALFSHAFT BAR [INCL. SHAFT, CLIPS]	\$99.99	1	Add
5	2205804	K-BOOT,INNER [INCL. CLAMPS, BOOT, GREASE]	\$39.99	1	Add
6	2205805	K-DOJ,INNER [INCL. CLIP, RING, RACE, BALLS, BELL]	\$89.49	1	Add
7		KIT, SNAP RING SET	Contact Dealer		
8	2205807	GREASE	Contact Dealer		

Notice: Some older parts displayed in this section are no longer available from Polaris. Contact your local Polaris dealer for availability. Additionally any item shown on the schematic comes as a unit of 1. If you need multiples of an item you must adjust the amount you order.



OVER
100,000
PARTS
AVAILABLE!

PARTS & GARAGE

MAINTENANCE

OIL & LUBRICANTS

MAINTENANCE FLUIDS

SERVICE PARTS

HO PARTS

BATTERIES & TIRE SEALANT

VEHICLE CARE & TRAILERING

POLARIS POWER

HD HEAVY DUTY PARTS



All Polaris parts are developed and tested to help you get the most out of your ride. Now, we're taking the passion of our riders, workers, and outdoor enthusiasts to the next level with HD Parts.

Engineered & designed for:

- Greater durability
- Enhanced performance
- Greater wear & tear capabilities
- All weather conditions

NEW WHEEL BEARINGS

Fully sealed for added protection against intrusions. Made of a higher grade steel for extended life in extreme conditions.

LOCATION	OE	HD HEAVY DUTY PARTS
FRONT WHEEL BEARINGS	3514822	3515090
	3514634	3515088
REAR WHEEL BEARINGS	3514917	3515087



NEW BUSHING KITS

Easily update the entire front and rear suspension.

- » 2830562 (SHOWN)
570 EFI '16-'20, 570 EFI X2 '16-'20, 570 EFI TOURING '16-'20, 570 EPS UTILITY '20, 450 HO '16-'20, 450 UTILITY '20
- » 2830563
570 SP '16-'19, 570 PREMIUM '19, 570 SP TOURING '16-'20



NEW BUSHINGS

The advanced material compound of the bushings enables tighter tolerances to reduce overall wear on the system, while the superior triple lip sealing prevents intrusion of the elements.



NEW WHEELS & TIRES

Class leading durability for off-road performance and traction for confident driving in extreme conditions.

- » 1524022-458 • HD WHEEL - 14x7
- » 5457498-458 • HD WHEEL CENTER CAP



COMING SOON BRAKES

Engineered to provide longer life and better stopping power while riding in extreme conditions.

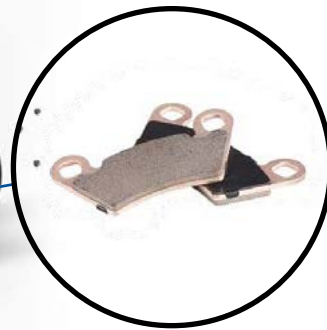

LOCATION	OE	HD HEAVY DUTY PARTS
FRONT UPPER BUSHINGS	5439874	1543367
FRONT LOWER BUSHINGS	5439874	1543367
	5436973	1543326
REAR UPPER BUSHINGS	5439874	1543367
	5438895	1543326
REAR LOWER BUSHINGS	5439874	1543367
	5436973	1543326

For more information regarding Polaris HD parts including vehicle compatibility, installation, and maintenance, please contact your authorized Polaris ORV dealer.

*Claims made based off testing and performance of Polaris HD Parts against standard OEM parts made by Polaris and competitor brands under normal use.

VISIT [POLARIS.COM/HDPARTS](https://www.polaris.com/hdparts) TO LEARN MORE

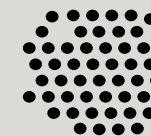

SAND



MUD



WATER



EXTREME COLD



EXTREME HEAT UP TO 130° F



HEAVY PAYLOADS



EXTENDED LIFE

PARTS & GARAGE

MAINTENANCE

OIL & LUBRICANTS

MAINTENANCE FLUIDS

SERVICE PARTS

HD PARTS

BATTERIES & TIRE SEALANT

VEHICLE CARE & TRAILERING

POLARIS POWER

BatteryMINDER®

ENSURE YOUR RIDE IS READY WHEN YOU ARE.

- Add years of capacity, power and range to new and older batteries, regardless of type or brand
- Never over- or under-charged in any temperature
- Leave your vehicle connected for months and return to fully charged and conditioned batteries
- Recover older or weak batteries that would normally need to be replaced

- Charge and maintain extra backup batteries as well as those in your vehicle
- Automatic turn-on, sleeps while keeping your batteries at full charge
- Easy push-button selector to change battery type or time



	2012 AGM 2-AMP	2012 LEAD ACID 2 AMP	1510 1.5 AMP	1.5 AMP CONVERTIBLE
PART NUMBER PRICE	2830438 \$121 ⁹⁹	2830531 \$109 ⁹⁹	2830404 \$79 ²⁹	2830511 \$91 ⁴⁹
VOLTAGE WARRANTY	12 V 5 Years	12 V 5 Years	12 V 10 Years	12 V 5 Years
CHARGING CURRENT	2AMP	2AMP	1.5AMP	1.5AMP
OVERCHARGE PROTECTION	Yes			
BATTERIES MAINTAINED	6 at one time		4 at one time	
BATTERY COMPATIBILITY	12 V Sealed AGM Lead-Acid	12 V Flooded (filler cap) and Sealed Maintenance-Free Batteries		
COMES WITH	• Non-fused battery clip cord set with Quick Connector	• BC-2410: 2' Non-fused battery clip cord set with Quick Connector • RTA-2415: 2' Fused ring terminal cord set with Quick Connector • ATS-1: Ambient Temperature Sensor	• Ambient temperature sensor (installed) • 12' power cord • Battery clip cord set with Quick Connector • Optional permanent mounting tab	• Auto-temp compensation sensor (installed) • Optional permanent mounting brackets & screws • Battery clips (fully-insulated, aircraft grade, 15A replaceable fuse) • Ring terminal assembly with 15A replaceable fuse
KEY FEATURES	Designed for high-performance specialty AGM sealed batteries	Diagnoses battery's condition - can predict failing batteries	Easy to use, economical	Convertible on-vehicle or bench top use

BATTERY MAINTENANCE TIPS

Extend your battery life with a BatteryMINDER® and these tips.

1. Store batteries in a cool, dry location.
2. Check that the battery connections are tight. Cables should not be able to be rotated or shifted by hand.
3. If your battery has a drain tube, make sure it is free of clogs.
4. Clean your battery - use a soft brush to scrub the top of the battery. Use baking soda to remove grease.
5. Connect a BatteryMINDER® after using your vehicle even if the vehicle is in regular use.

TIRE SEALANT

HOW IT WORKS

Tire sealant remains liquefied inside your tire until a leak develops in the tire or wheel.



Once a leak occurs, the tire sealant rushes out of the tire and quickly creates a permanent solid plug.

The plug maintains the pressure of the tire so you can continue your ride.



HOW MUCH TIRE SEALANT DO YOU NEED?

$$\begin{array}{c} \text{TIRE HEIGHT (IN.)} \\ | \\ \text{Ex: } 27'' \end{array} \times \begin{array}{c} \text{TIRE WIDTH (IN.)} \\ | \\ 10'' \end{array} / 5 = \begin{array}{c} \text{OUNCES REQUIRED PER TIRE} \\ | \\ 54 \text{ oz.} \end{array}$$

FOR A FULL APPLICATION CHART, VISIT POLARIS.COM/TIRESEALANTCHART

PREMIUM TIRE SEALANT

- Instantly seals and repairs rim, bead leaks, and punctures up to 1/4" on standard tires, and 3/4" on heavy ply tires
- Helps maintain air pressure for the life of the tire
- Helps seal the tire bead against the wheel
- 100% water soluble for easy cleanup
- Will not rust, corrode, or pit wheels
- Creates permanent repair
- Remains fluid and effective in temperatures down to -45° F
- Easily installed through existing tire valve stem with valve core removed

- » 32 OZ. • 2830484 • \$25⁹⁹
- » 1 GALLON • 2830485 • \$89⁹⁹
- » 5 GALLON • 2830486 • \$364⁹⁹
- » 5 GALLON PUMP • 2830487 • \$163⁴⁹
- » 55 GALLON • 2830489
- » 275 GALLON • 2830488

24 X 7 COVERAGE | BE PREPARED FOR ANYTHING

BatteryMINDER® ACCESSORIES



BatteryMINDER® 12' CABLE

- Made with heavy-duty 16 gauge black zip cord featuring automotive SAE bullet connectors

» 2830410 • \$15⁹⁹



BatteryMINDER® VPP-12:12/24 VOLT VEHICLE POWER PLUG

- Allows easy connection to vehicle's battery through lighter or 12/24V power port with replaceable 15 amp fuse

» 2830518 • \$12⁹⁹



BatteryMINDER® SPLITTER

- Connect two batteries simultaneously for easy battery maintenance
- Cap includes a set of ring terminals

» 2830409 • \$30⁴⁹



BatteryMINDER® RING TERMINAL

- Features 24-inch long 18-gauge wire
- Plug has standard 5/16" negative and 3/8" positive terminals
- Replaceable 15 amp in-line fuse for circuit protection

» 2830437 • \$12⁹⁹



BatteryMINDER® EZ CONNECT

- Allows for quick and easy connecting and disconnecting of your BatteryMINDER®
- Includes a set of ring terminals

» 2830411 • \$42⁹⁹

SHOP ACCESSORIES



POLARIS X3 CREEPER

- Three positions: flat, 45-degree angle or seated work stool
- Helps you perform any repair with ease
- Stay dry and warm away from cold, wet cement floors
- Easily stores away when not in use

» BLACK • 2830429 • \$182⁹⁹



POLARIS MAGNETIC PARTS TRAY

» SILVER • 2830432 • \$18⁹⁹



POLARIS 33" TELESCOPIC MAGNET

» BLACK • 2830435 • \$6⁹⁹



POLARIS 12" HI-TORQUE RATCHETING DRIVER

» BLACK / BLUE • 2830434 • \$24⁹⁹



POLARIS LED POCKET FLASHLIGHT

» BLACK • 2830436 • \$30⁴⁹

CV BOOT REPAIR KIT

FIX ON THE GO | TEMPORARY COVERAGE

- A quick trail side fix to increase trail time
- The flexible and durable boot material expands over a cone tool for CV boot repairs, without disassembling CV axles
- Universal fit – works as a temporary fix for most powersports axles
- All components fit inside the cone, and a cover is provided for compact durable storage
- Easily fits in a cargo box, attached to the roll cage, in the glovebox, or many other storage locations



Items shown are contained inside cone

ATV CV BOOT REPAIR KIT

Kit includes the following items:

- (1) Expandable CV Boot
- (1) Reusable Cone Tool
- (2) CV Boot Clamps
- (1) Tube of Silicone Lube
- (1) Grease Packet
- (1) Cone Cover

» 2830528 • \$31⁹⁹

ATV TRAIL BOOT ONLY

» 2830529 • \$31⁹⁹

UTV

» CV REPAIR KIT 2830526 • \$18⁹⁹

» TRAIL BOOT ONLY 2830527 • \$36⁹⁹

SEE HOW THE CV BOOT REPAIR KIT WORKS AT POLARIS.COM/MAINTENANCE-VIDEOS



HOW TO INSTALL

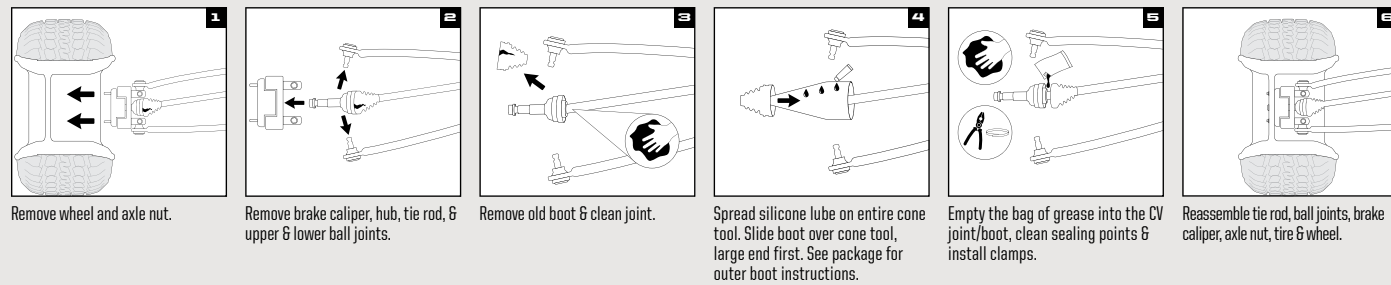

Refer to your service manual for further instructions and torque specifications.
*Designed for temporary CV boot repair. Purchase the OEM CV Boot for a permanent repair.

KEEP IT CLEAN

VEHICLE SHINE

MUD SHIELD PRE-TREATMENT

- Inhibits the adhesion of dirt, mud, and snow, making cleaning your vehicle faster and easier.

» 16 OZ. AEROSOL • 2830229 • \$12⁹⁹



POLARIS POLISH

- Easy protection and shine—spray on, wipe off, and go. For ideal use on painted and plastic surfaces. Contains carnauba wax.

» 12 OZ. • 2830228 • \$12⁹⁹



VEHICLE & EQUIPMENT WASH

- Concentrated professional grade formula powers through vehicle buildup, dirt and grease with a spot-free rinse. Treat up to 32 gals. Biodegradable product.

» 1 GAL. • 2830417 • \$19⁹⁹

» 5 GAL. • 2830422 • \$69⁹⁹



SHOP

POLARIS SHOP TOWELS

» 200 CT WITH DISPENSER (SHOWN) 2830402 • \$69⁹⁹

» 200 CT REFILL • 2830403 • \$28⁹⁹

» 64 CT REFILL • 2830440 • \$19⁹⁹



POLARIS HEAVY-DUTY SCRUBBER WIPES

» 90 CT • 2830441 • \$6⁹⁹



ALL-PURPOSE CLEANER PLUS

- Professional-grade formula removes built-up stains from shop floors, work benches, and other hard surfaces. VOC-free, environmentally-friendly, and biodegradable.

» 1 GAL. • 2830414 • \$19⁹⁹

» 5 GAL. • 2830416 • \$69⁹⁹



HD CLEANER & DEGREASER

- Professional-grade, biodegradable, high-foaming formula dissolves and removes tough stains and soils.

» 1 GAL. • 2830418 • \$23⁹⁹

» 5 GAL. • 2830420 • \$95⁹⁹



BRING IT EVERYWHERE

TRAILERING



CALIBER® RAMP PRO

- Designed for ATVs and UTVs up to 50" wide
- Integrated grip glides for ultimate traction

- Folding sides for easy transportation & storing

» 52" x 90" • 2884576 • \$519⁹⁹



ALUMINUM ARCHED LOADING RAMPS

» 76" x 12" • 2,000 lb • 2875384 • \$279⁹⁹

» 88" x 12" • 3,000 lb • 2875386 • \$459⁹⁹



LIGHTWEIGHT TRI-FOLD RAMPS

- Ramp folds up for transport
- Capacity for up to 1,500 lb
- Safety straps included

» 72" x 51" • 2875385 • \$309⁹⁹

» 82" x 51" • 2875860 • \$369⁹⁹



FOLDING ALUMINUM ARCHED RAMPS

- Ramp folds up for transport
- Capacity up to 3,000 lb
- Safety straps included

» 88" x 12" • 2875387 • \$379⁹⁹

HITCHES

3:1 HITCHES VERSATILE 3 IN 1 FUNCTIONALITY

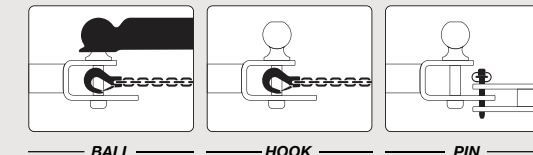

- Ball, pin and hook design
- Durable, rust resistant steel with black powdercoated finish

- Removable ball
- HD 5/8" pin and clip



HITCH WITH 2" BALL

» 2" x 2" RECEIVER 2830522 • \$48⁹⁹

» 1 1/4" x 1 1/4" RECEIVER 2830523 • \$48⁹⁹



1 7/8" BALL

- 1 7/8" replacement ball for hitch
- Designed to work with 3:1 Hitch

» 2830524 • \$12⁹⁹



RECEIVER HITCH

» 2" RECEIVER TONGUE 2875320 • \$59⁹⁹

» FRONT HITCH RECEIVER 2878846 • \$169⁹⁹

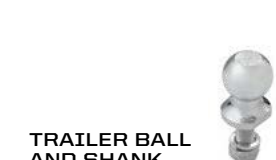

TRAILER BALL AND SHANK

» 1 7/8" BALL • 2877602 • \$18⁹⁹

» 2" BALL • 2877603 • \$18⁹⁹

STRAPS & ROPES



RECOVERY STRAP

- 2" x 30' (18,000 lb)
- Comes with carry bag

» 2884033 • \$74⁹⁹



RATCHET STRAP

- 1.5" x 15' straps, 2 Pack
- Heavy duty webbing
- 5,500 lb maximum load, 1,833 lb working load

» 2884031 • \$59⁹⁹



RATCHET STRAP

- 2" x 20' Ratchet Straps
- Heavy duty webbing, floating D-rings, double J-hooks

- 10,000 lb maximum load, 3,300 lb working load

» 2884032 • \$43⁹⁹



SHOCK STRAPS

- 1.5" 3,000 lb breaking strength
- Keeps tension on tie-down straps to secure load, 2 Pack

» 1.5" x 15' • 2883296 • \$109⁹⁹

» 1.5" x 7' • 2883295 • \$94⁹⁹

COVERS



TRAILERABLE COVER

» 2876614 • \$209⁹⁹

ALL SPORTSMAN EXCEPT 300/400, XP 1000 S, SCRAMBLER XP 1000 S, X2, TOURING REPLACEMENT STRAP 2871912.

» 2877999 • \$209⁹⁹

ALL SPORTSMAN TOURING REPLACEMENT STRAP 2871912.

» 2884188 • \$219⁹⁹

XP 1000 S, SCRAMBLER XP 1000 S

PARTS & GARAGE

MAINTENANCE

OIL & LUBRICANTS

MAINTENANCE FLUIDS

SERVICE PARTS

HD PARTS

BATTERIES & TIRE SEALANT

VEHICLE CARE & TRAILERING

POLARIS POWER



NEW P2000i Inverter Generator	2830532	\$899 99	1600 Running Watts	2000 Starting Watts	16.7 Max Amps at 120V	7.6 Run Time at 25% Load w/ Smart Throttle (hrs)	62 Noise Level at 25% Load (dBA)
---	---------	-----------------	------------------------------	-------------------------------	---------------------------------	--	--

FEATURES

- Extension Cord Management
- Multi Functional Digital Display
- Illuminated Control Panel
- Multi Handle Design
- Parallel Capable

BEST USED FOR

- Tailgating
- Off-Grid
- Camping



ACCESSORIES	2830536 INVERTER PARALLEL KIT	2884865 HIGH ALTITUDE MODIFICATION KIT
	2830540 ALL WEATHER COVER	2879383 GENERATOR OIL

NEW P3200iE Inverter Generator	2830533	\$1899 99	2800 Running Watts	3200 Starting Watts	23.3 Max Amps at 120V	10.1 Run Time at 25% Load w/ Smart Throttle (hrs)	67 Noise Level at 25% Load (dBA)
--	---------	------------------	------------------------------	-------------------------------	---------------------------------	---	--

FEATURES

- Key Fob Remote Start
- Multi Functional Digital Display
- Fuel Gauge
- Extension Cord Management
- Parallel Capable

BEST USED FOR

- DIY Remodeling
- One Room Backup
- Camping



ACCESSORIES	2830536 INVERTER PARALLEL KIT	2884866 HIGH ALTITUDE MODIFICATION KIT
	2830541 ALL WEATHER COVER	2879383 GENERATOR OIL



NEW P5500 Open Frame Generator	2830534	\$1799 99	5000	5500	20/30	5	75
			Running Watts	Starting Watts	Max Amps at 120/240V	Run Time (hrs)	Noise Level (dBA)

FEATURES



Extension Cord Management



Fuel Gauge



Electric Start



Rough Terrain Wheel

BEST USED FOR

-  Construction
-  Home Backup
-  RV-ing



ACCESSORIES	2830542 ALL WEATHER COVER 2884867 HIGH ALTITUDE MODIFICATION KIT	2879383 GENERATOR OIL
--------------------	---	-----------------------

NEW P6500 Open Frame Generator	2830535	\$1999 99	6000	6500	20/30	5	75
			Running Watts	Starting Watts	Max Amps at 120/240V	Run Time (hrs)	Noise Level (dBA)

FEATURES



Extension Cord Management



Fuel Gauge



Electric Start



Rough Terrain Wheel

BEST USED FOR

-  Construction
-  Home Backup
-  RV-ing



ACCESSORIES	2830542 ALL WEATHER COVER 2884867 HIGH ALTITUDE MODIFICATION KIT	2879383 GENERATOR OIL
--------------------	---	-----------------------

VISIT POLARISPOWER.COM FOR ALL PRODUCT FEATURES

RIDING GEAR



OFF-ROAD RIDING JERSEYS

S-3XL | \$45.99

- Mesh ventilated panels for maximum airflow
- Elastic sleeves with non-restrictive cuffs

OFF-ROAD RIDING GLOVES

S-3XL | \$32.99

- Adjustable wrist closure for a custom fit
- Silicon finger grips and neoprene knuckle protection

YOUTH JERSEY

S-XL | \$34.99

MULTICOLOR | 2860652
BLUE | 2860651

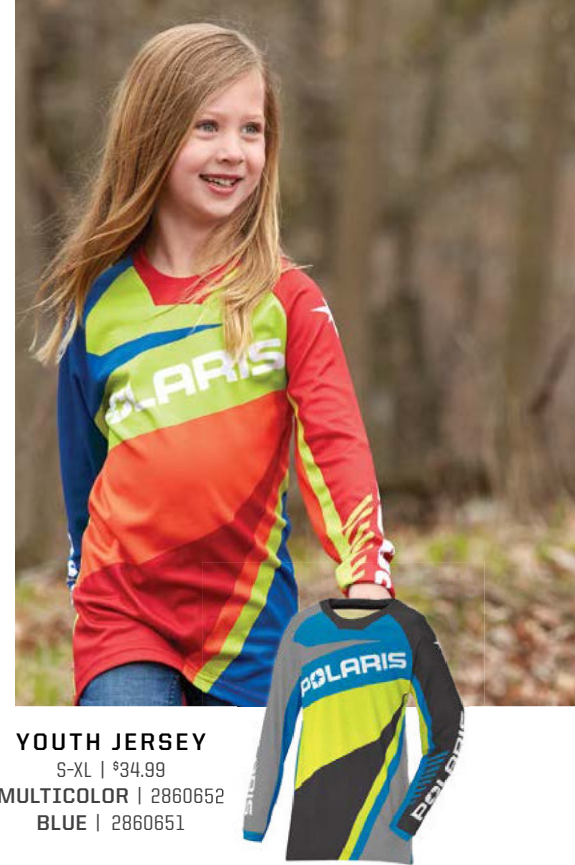

BLACK
JERSEY | 2860646
GLOVE | 2860641

BLUE/LIME
JERSEY | 2860647
GLOVE | 2860642

MULTICOLOR
JERSEY | 2860648
GLOVE | 2860643

NAVY/PINK
JERSEY | 2860649
GLOVE | 2860644

RED
JERSEY | 2860650
GLOVE | 2860645

TEKVEST® ULTIMATE PROTECTION



TEKVEST® SUPERSOFT
S-3XL | 2862190 | \$529.99

- Zip-off fleece collar diffuses rising body heat to reduce fogging
- Drop-tail design for extended coverage
- 2-stage pockets



TEKVEST® FREESTYLE
S-3XL | 2862189 | \$429.99

- Strong, protective ultra high molecular weight panels cover shoulders
- Front and rear mesh panels promote cooling airflow



TEKVEST® YOUTH
70-100 lbs | 2862191 | \$353.99

- Adjustable side straps and arm straps
- Strong, protective ultra high molecular weight panels cover shoulders

COOLING SHIRTS

MEN'S LONG SLEEVE
COOLING SHIRT
S-3XL | 2860638 | \$58.99

WOMEN'S LONG SLEEVE
COOLING SHIRT
S-3XL | 2860640 | \$58.99



FABRIC TECHNOLOGY DESIGNED TO KEEP YOU COOL

Cooling fabric designed with sun protection in mind. Our chemical-free fabric Coolcore® reduces the surface temperature on our cooling shirt up to 30%, so you don't overheat. It carries a 50 Ultraviolet Protection Factor rating, the highest attainable, blocking 98% of harmful UV rays.

SHORT SLEEVE COOLING SHIRTS

MEN'S
S-3XL | 2860634 | \$45.99

WOMEN'S
S-3XL | 2860636 | \$45.99

HEATED VEST



HEATED VESTS

S-3XL | \$266.99

NEW WOMEN'S BLACK | 2861440
NEW MEN'S BLACK | 2861441

- Replacement / Spare Battery: 2869692
- Replacement Cord: 2869694

RAIN SUIT



RAIN JACKET
GRAY
S-3XL | 2869527 | \$129.99

RAIN PANTS
GRAY
S-3XL | 2869528 | \$109.99

- 100% waterproof lightweight and packable nylon
- YKK® Zippers
- Rain jacket has removable hood

HELMETS



RED/BLACK
XS-4XL
2861470



[ALTITUDE]



BLACK
XS-4XL
2861469



BLACK/RED
XS-4XL
2861472



\$532⁹⁹
CARBON FIBER
BLACK/LIME
XS-4XL | 2861473

NEW 509[®] ALTITUDE 2.0 HELMET

\$399⁹⁹

Lightweight Design, performance-infused style and features with all-day comfort

SHELL

- Strong, lightweight construction of carbon fiber or fiber glass

WEIGHT

- Composite as low as 1,260g
- Carbon fiber as low as 1,150g

FEATURES

- Superior fit for all-day comfort
- Removable Pro Series breath box provides excellent ventilation and air flow
- One-piece eye-port creates draft-free seal with 509[®] goggles
- Magnetic Fidlock[®] chin-strap technology and integrated GoPro[®] mount
- DOT- and ECE 22.05-approved



[TENACITY]



BLACK
XS-2XL
2861557



BLACK/GRAY
XS-2XL
2861558



BLACK/WHITE
XS-2XL
2861560



WHITE/RED
XS-2XL
2861561



PINK
XS-2XL
2861562

NEW TENACITY 4.0 HELMET

\$186⁹⁹

Combination of modern style and premium protection with incredible value

SHELL

- Shock-resistant, injection-molded thermoplastic

WEIGHT

- 1,500g

FEATURES

- Through-flow, full-helmet ventilation
- ProClip quick release chin strap allows you to fasten the chin strap in seconds
- Removable breath box
- Tool-less adjustable roost shield
- Removable, washable liner
- DOT- and ECE 22.05-approved

GOGGLES



BLACK
2868669

RED
2868670

LIME
2868671

BLUE
2868667

KINGPIN 509[®] DIRT GOGGLE

\$74⁹⁹

Premium Materials, attractive price

FEATURES

- Oversized spherical lens delivers optimal peripheral vision
- Metal tear off posts provide strength and durability
- Quick-change technology allows you to run the best lens tint for conditions



ORANGE
2868668

TRAIL GOGGLE

\$46⁹⁹

Clear Vision at a Great Value

FEATURES

- Offers a distortion-free view with anti-scratch, anti-fog and UV-blocking technology
- Large lens opening enables greater peripheral vision



BLACK
2867917

OUTERWEAR



FORCE JACKET

WINDBREAKER JACKET

NEW
FORCE JACKET \$186⁹⁹

Versatile, lightweight jacket ideal for layering or wearing as a casual jacket.

MEN'S | S-3XL | 2861432



WOMEN'S
 S-3XL | 2861433

NEW
WINDBREAKER JACKET \$132⁹⁹

Lightweight, windproof jacket that provides protection while riding.

- 100% polyester windproof fabric
- 3 external pockets allow for maximum storage

S-3XL | 2861541



GRAY/BLUE
 S-3XL | 2861439

BLACK
 S-3XL | 2861434

NEW
SOFTSHELL JACKET \$172⁹⁹

Lightweight performance that's surprisingly warm and perfect for everyday wear

- DWR prevents precipitation from saturating the jacket's exterior
- Three external and one internal pocket
- Lined with 280 grams of soft fleece for warmth
- Removable hood and underarm venting

MAROON
 S-3XL | 2861438

BLACK
 S-3XL | 2861437

GRAY
 S-3XL | 2861435

BLACK/BLUE
 S-3XL | 2861436

WOMEN'S

MEN'S



FLANNEL JACKET
BRONZE
 S-3XL | 2860864

WORK JACKET
FOREST GREEN
 S-3XL | 2860862

FLANNEL JACKET \$129⁹⁹

CHARCOAL
 S-3XL | 2860865

WORK JACKET \$207⁹⁹

NEW
BLACK S-3XL | 2861608
GRAY S-3XL | 2860863

This stylish flannel jacket is designed to keep you riding on brisk days. Soft yet durable brushed flannel with a Sherpa fleece lining offers excellent insulation without the bulkiness of a winter jacket.

This warm and rugged jacket was engineered to be tough enough for work yet stylish enough for play.

External features:

- Constructed of Nylon 6, a durable, tear-resistant non-stretch woven fabric
- Coated with Durable Water Repellency (DWR) to provide water-resistance in the elements
- Four external pockets for maximum gear storage

Internal features:

- 80 gram 3M® Thinsulate® for added warmth
- Built in action back for increased range of motion
- Internal zipper pocket
- Brushed flannel trim

LAYERING



TECH QUARTER ZIP
PINK
 S-3XL | 2861448

NORTHSTAR MID LAYER
BLACK/GRAY
 S-3XL | 2869925

NEW
TECH QUARTER ZIP \$79⁹⁹

Excellent for ride layering, comfortable and stylish stand-alone.

NORTHSTAR MID LAYER \$119⁹⁹

Breathable fleece mid-layer is perfect for adding warmth or as a stand-alone shirt.

WOMEN'S

MEN'S



BLACK
 S-3XL | 2861447



BLUE
 S-3XL | 2861443



BLACK
 S-3XL | 2861442



NEW
BLACK/RED
 S-3XL | 2861445

APPAREL & HELMETS

OUTERWEAR & PROTECTION

LIFESTYLE & CAPS

CAMO & GIFTS

LIFESTYLE



NEW
MEN'S ICON HOODIE
 S-3XL | \$72.99
 BLACK | 2861496
 GREEN | 2861495



NEW
WOMEN'S TECH HOODIE
 S-3XL | \$86.99
 GRAY | 2861508
 MAROON | 2861509

HATS & T-SHIRTS



NEW
MEN'S ALL-IN TEE
 S-3XL | \$32.99
 BLACK | 2861574
 GRAY | 2861575



NEW
BADGE TRUCKER HAT
 One-Size | \$32.99
 GRAY | 2861531
 NAVY | 2861532
 BLACK | 2861533
 PINK | 2861549
 MAROON | 2861537



NEW
TONAL HAT
 L/XL | \$32.99
 BLACK | 2861526
 NAVY | 2861525



NEW
CORE HAT
 One-Size | \$32.99
 NAVY | 2861523
 BLACK | 2861524



NEW
CHECKERED HAT
 One-Size | \$32.99
 NAVY | 2861520
 GRAY | 2861521
 BLACK | 2861522

APPAREL & HELMETS

OUTWEAR & PROTECTION

LIFESTYLE & CAPS

CAMO & GIFTS



NEW
MEN'S CREW SWEATSHIRT
 S-3XL | \$64.99
 GREEN | 2861498
 NAVY | 2861497



NEW
WOMEN'S ICON HOODIE
 S-3XL | \$72.99
 MAROON | 2861507
 BLACK/PINK | 2861506



NEW
WOMEN'S ALL-IN TEE
 S-3XL | \$32.99
 BLACK | 2861598
 OLIVE | 2861599



NEW
MEN'S PERFORMANCE LONG SLEEVE
 S-3XL | \$52.99
 ROYAL | 2861589
 GRAY | 2861588



NEW
MEN'S TECH HOODIE
 S-3XL | \$86.99
 BLACK/BLUE | 2861494
 GRAY | 2861493



NEW
WOMEN'S CHECKERED HOODIE
 S-3XL | \$52.99
 BLACK | 2861609
 BLUE | 2861610



NEW
MEN'S BACK GRAPHIC TEE
 S-3XL | \$32.99
 GRAY | 2861568
 NAVY | 2861569



NEW
MEN'S STAMP TEE
 S-3XL | \$32.99
 GRAY | 2861565
 GREEN | 2861564

CAMO

NEW

STEALTH CAMO HAT
One-Size | \$32.99
CAMO | 2861527



NEW

NORTHSTAR MID LAYER
S-3XL | \$119.99
CAMO | 2861542

NEW

CAMO SOFTSHELL JACKET
S-3XL | \$172.99
CAMO | 2861543



CAMO POLY HOODIE
S-3XL | \$71.99
BLACK | 2860718



HUNTER CAMO HOODIE
S-3XL | \$67.99
OLIVE | 2868716
GRAY | 2860728



CAMO FULL ZIP
S-3XL | \$79.99
OLIVE | 2869590



MEN'S CAMO TEE
S-3XL | \$32.99
GRAY | 2860709
BLACK | 2860710



CAMO HOODIE
S-3XL | \$74.99
WOMEN'S | 2867898
MEN'S | 2867879



CAMO TRUCKER HAT
One-Size | \$32.99
BLACK | 2860613
PINK | 2860614

GIFTS & BRANDED MERCHANDISE

POLARIS STEEL SIGN (14" x 36")
2860868 | \$168.99



PINT GLASS (SET OF 2)
2860815 | \$25.99

POLARIS WOODEN COASTERS WITH BOTTLE OPENER
2860869 | \$32.99

DRINKWARE



PREMIUM COOZIE
2860829 | \$10.99



NEW
17oz WATER BOTTLE
2861611 | \$32.99



NEW
12oz CAMPER MUG
2861612 | \$39.99



NEW
15oz CAMPFIRE MUG
2861613 | \$26.99

RECREATION/GARAGE



NEW
EVENT FOLDING CHAIR
2861617 | \$59.99



NEW
FOLDING TABLE
2861620 | \$66.99



POLARIS WOOD SIGN (10.5" x 24")
2860866 | \$97.99



NEW
NECK GAITERS
One-Size | \$16.99
CAMO | 2861948
BLACK | 2861953

COLLECTIBLES



NEW
KEYCHAIN
2861614 | \$8.99



NEW
LEATHER KEYCHAIN
2861616 | \$8.99



MINI SPORTSMAN TOY
2860821 | \$12.99



BOTTLE OPENER
2860818 | \$19.99

FORGE YOUR OWN PATH



CONNECT ONLINE
SEARCH "PolarisORV"



BUILD YOUR POLARIS SPORTSMAN

VISIT [POLARIS.COM/SPORTSMAN](https://www.polaris.com/sportsman)

TO SEE ALL YOUR OPTIONS & ACCESSORIES ON YOUR NEW MACHINE FROM EVERY ANGLE!

1 CHOOSE
MODEL

2 CHOOSE
TRIM

3 CHOOSE
COLOR

4 CHOOSE
ACCESSORIES



WARNING: POLARIS OFF-ROAD VEHICLES CAN BE HAZARDOUS TO OPERATE AND ARE NOT INTENDED FOR ON-ROAD USE. DRIVER MUST BE AT LEAST 16 YEARS OLD WITH A VALID DRIVER'S LICENSE TO OPERATE. ALL RIDERS SHOULD ALWAYS WEAR HELMETS, EYE PROTECTION AND PROTECTIVE CLOTHING AND FOOTWEAR. READ, UNDERSTAND AND FOLLOW YOUR OWNER'S MANUAL. RIDE WITHIN THE LIMITS OF YOUR OWN ABILITIES AND NEVER ENGAGE IN STUNT OR EXHIBITION DRIVING. NEVER RIDE UNDER THE INFLUENCE OF DRUGS OR ALCOHOL. ALL RIDERS SHOULD TAKE A SAFETY TRAINING COURSE. CALL 800-342-3764 FOR ADDITIONAL INFORMATION.

UNLESS NOTED, TRADEMARKS ARE THE PROPERTY OF POLARIS® INDUSTRIES INC. 3M® and Thinsulate® are registered trademarks of 3M Company. 509® is a registered trademark of Teton Outfitters, LLC. Batteryminder® is a registered trademark of VDC Electronics Inc. Bluetooth® is a registered trademark of Bluetooth Sig, Inc. Browning® is a registered trademark of BROWNING INTERNATIONAL S.A.. Caliber® is a registered trademark of Caliber, Inc. CAMSO® is a registered trademark of Artic Investments S.A. CREE® is a registered trademark of Cree, Inc. COOLCORE® is a registered trademark of COOLCORE LLC. Fidlock® is a registered trademark of Fidlock GmbH. FOX® is a registered trademark of Fox Factory Inc. High Lifter® is a registered trademark of High Lifter Products, Inc. Kolpin® is a registered trademark of Polaris Industries, Inc. Mossy Oak® is a registered trademark of Haas Outdoors, Inc. OGIO® is a registered trademark of Ogio International, Inc. Rigid® is a trademark of JST Performance, LLC d/b/a Rigid Industries, LLC. Rockford Fosgate® is a registered trademark of Rockford Corporation. TEKVEST® is a registered trademark of 1181676 ONTARIO INC. Tiger Drylac® is a registered trademark of TIGER COATINGS GMBH & CO. KG. Velcro® is a registered trademark of VELCRO BVDA. Yeti® is a registered trademark of Yeti Coolers, LLC. YKK® is a registered trademark of YKK Corporation. YouTube® is a registered trademark of Google Inc. PRICES, FITMENT AND AVAILABILITY ARE SUBJECT TO CHANGE AT ANY MOMENT. COPYRIGHT © 2021 POLARIS INDUSTRIES INC. ALL RIGHTS RESERVED.

POLARIS

MY21 SPTSMN APP ACC CAN • 9948054

MAY 2021