

CANADA VERSION

POLARIS *GENERAL*

2022

ACCESSORIES + APPAREL



ELEVATE YOUR ADVENTURE

OFF-ROAD'S PREMIER FAMILY OF ADVENTURE SIDE-BY-SIDES. No matter which GENERAL you choose, you begin every adventure with the best performance, the greatest utility, and the most comfortable ride you can get in a side-by-side. When you customize with Polaris Engineered Accessories you have the confidence to take on any task or any trail.



BRING IT ALL. BRING IT ON.

Introducing all-new, industry-exclusive Rhino-Rack® storage solutions for GENERAL. Transform your vehicle for work, play or anything in between with durable and easy-to-use bed racks and load securing attachments.

2022 LINEUP

SEE THE FULL LINEUP AT [POLARIS.COM/GENERAL](https://www.polaris.com/general)

GENERAL XP

XP 1000 (2 & 4 SEAT)



GENERAL XP 1000

- WALKER EVANS VELOCITY SHOCKS
- SPORT ROOF
- POLARIS HD 4,500 LB. WINCH WITH AUTO-STOP
- STAGE 1 AUDIO SYSTEM BY ROCKFORD FOSGATE®
- SPORT LOW PROFILE FRONT BUMPER
- CONVEX REAR VIEW MIRROR
- 30" PRO ARMOR CRAWLER XG
- XL FENDER FLARES

RIDE COMMAND WITH ROCKFORD FOSGATE® STAGE 3 AUDIO MODEL AVAILABLE.

XP 1000 TRAILHEAD EDITION (2 & 4 SEAT)



GENERAL XP 1000 TRAILHEAD EDITION

XP PLUS:

- SPORT ROOF
- RIDE COMMAND
- STAGE 3 AUDIO SYSTEM BY ROCKFORD FOSGATE®
- ADVENTURE REAR RACK
- 11" PRO ARMOR LIGHT BAR
- POLARIS HD 4,500 LB. WINCH WITH AUTO-STOP
- 30" PRO ARMOR CRAWLER XG
- CONVEX REAR VIEW MIRROR
- 3D EMBOSSED TOPOGRAPHY GRAPHICS AND CUSTOM COLOR PACKAGE

GENERAL

DELUXE (2 & 4 SEAT)



GENERAL 1000 DELUXE

PREMIUM PLUS:

- FOX® PODIUM X 2.0 QS3 SHOCKS
- SPORT ROOF
- STAGE 1 AUDIO SYSTEM BY ROCKFORD FOSGATE®
- CONVEX REAR VIEW MIRROR

RIDE COMMAND WITH ROCKFORD FOSGATE® STAGE 3 AUDIO MODEL AVAILABLE.

PREMIUM (2 & 4 SEAT)



GENERAL 1000 PREMIUM

SPORT PLUS:

- AUTOMOTIVE PAINT
- MATTE BLACK CAST ALUMINUM WHEELS
- 27" MAXXIS® CORONADO TIRES
- SPORT LOW PROFILE FRONT BUMPER
- POLARIS HD 4,500 LB. WINCH WITH AUTO-STOP
- LED HEAD AND TAIL LIGHTS
- 4-SEAT ONLY: FOX® PODIUM X 2.0 QS3 SHOCKS

SPORT (2 SEAT)



GENERAL 1000 SPORT

- 100 HP PROSTAR ENGINE
- 600 LB. DUMPING BOX
- STANDARD HALF DOORS
- ELECTRONIC POWER STEERING (EPS)
- POLARIS LOCK & RIDE COMPATIBLE
- VERSATRAC TURF MODE

CONTENTS

ACCESSORIES 06

- WINDSHIELDS & REAR PANELS08
- DOORS10
- ROOFS12
- VEHICLE & RIDER PROTECTION13
- STORAGE14
- CAB COMFORT17
- HUNT18
- POLARIS NORTHSTAR COOLERS20
- CONNECTED TECHNOLOGY22
- AUDIO24
- LIGHTING26
- WHEELS & TIRES28
- WINCHES36
- PLOWS & TRACKS37

PARTS & GARAGE 38

- MAINTENANCE38
- OIL & LUBRICANTS40
- MAINTENANCE FLUIDS42
- BATTERIES & GARAGE ACCESSORIES44
- HD PARTS46
- SERVICE PARTS48
- TIRE SEALANT & TRAILERING50
- POLARIS POWER52

APPAREL 58

- RIDING GEAR58
- HELMETS & GOGGLES60
- MEN'S APPAREL62
- WOMEN'S APPAREL68
- MERCHANDISE70



BUILD YOUR OWN
AT [POLARIS.COM/GENERAL](https://www.polaris.com/general)

DESIGNED



Designed by the same people who designed your vehicle.

TESTED



Extensively tested in the field so you ride with 100% confidence.

TRUSTED

ACCESSORIES
BACKED BY A



WARRANTY

65 years in the business.
The #1 name in Off-Road.



INTRODUCING OUR NEWEST PARTNER



Introducing an industry exclusive – Rhino-Rack® storage solutions designed specifically for Polaris GENERAL. From opposite sides of the globe, the most capable machines in the off-road world meet a trusted outdoor adventure brand to deliver industry-exclusive bed racks and accessories to help Polaris GENERAL users have more fun and get more done. Designed for perfect integration and tested to off-road standards, a Rhino-Rack®-equipped GENERAL will help you get more storage capacity out of your machine – so you can stay prepared for whatever the day may bring.



WE HOLD OUR PARTNERS TO THE SAME STANDARDS



WHEELS, TIRES & LIGHTING DESIGNED WITH
POLARIS TO MAXIMIZE PERFORMANCE
P. 27 & 28



A GLOBAL LEADER IN AUDIO INNOVATION,
DESIGN & ENGINEERING
P. 24



PRODUCTS SO GOOD THEY REPLACE
OR REPAIR THEM FOR LIFE
P. 26



MAKING PRODUCTS FOR AVID
SPORTSMEN SINCE 1943
P. 18



DIGITAL GAUGES FOR
POWERSPORTS RIDERS
P. 23



BRING IT ALL.
BRING IT ON.
P. 14

ENGINEERED TO TAKE ON THE ELEMENTS

POLARIS ENGINEERED ADVANTAGES

TESTED & PROVEN



DUST



WIND

BUILD YOUR CAB SYSTEM STARTING ON P. 08



COMFORT YOU HAVE TO EXPERIENCE TO BELIEVE

Our cab components create an experience enhancing interior, offering supreme comfort to your vehicle.



PROFILE TUBE DESIGN

Contours built into the cage deliver a premium sealing surface.



PERFECT FIT, PERFECT SEAL

A 360° gasket seal provides our tightest-sealing cab.



LOCK & RIDE EASY ON & OFF

Adapt to your needs and environment with exclusive tool-less, easy-on, easy-off Lock & Ride components.



PLUG & PLAY ELECTRICAL

EFFORTLESSLY ADD LIGHTS, HEAT, WIPERS & AUDIO.

A revolution in electrical accessory integration, the Polaris PULSE Electrical System allows for a simple plug & play approach for adding power to Polaris Engineered Accessories.

Look for  to identify Polaris PULSE ready accessories.





ELEVATE

YOUR ADVENTURE

- LOCK & RIDE** Vented Windshield - Hard Coat Poly: P. 08
- Windshield Wiper & Washer System: P. 08
- Rear Sport Bumper: P. 13
- Extreme Kick-Out Rock Sliders: P. 13
- Rhino-Rack® Rear Bed Rack: P. 14
- Polaris Northstar 15 Qt Cooler: P. 20
- Pro Armor 33" Combo LED Light Bar: P. 27
- Light Bar Harness: P. 27



BLAZE A NEW TRAIL

- LOCK & RIDE** Vented Windshield - Hard Coat Poly: P. 08
- Sport Roof - Poly: P. 12
- XL Fender Flares: P. 13 **NOT SHOWN**
- LOCK & RIDE** Cargo Box: P. 14
- RIGID® SR-Series Combo Light Bar: P. 27
- Pro Armor Wheel & Tire Set: P. 35
- 29" Mud XC & 14" 4204 - Matte Black
- Winch: P. 36



PREPARE FOR THE HUNT

- LOCK & RIDE** Full Windshield - Glass: P. 08
 - Windshield Wiper & Washer System: P. 08
 - LOCK & RIDE** Rear Panel - Glass: P. 09
 - Polaris PULSE LED Light Bar Harness: P. 17
 - Pro Armor 33" Combo LED Light Bar: P. 27
- In addition to stock accessories



SPORT ESSENTIALS

- LOCK & RIDE** Full Windshield - Glass: P. 08
- Windshield Wiper & Washer System: P. 08
- LOCK & RIDE** Rear Panel - Glass: P. 09
- Premium Roof - Poly: P. 12
- Polaris Northstar 30 QT Cooler: P. 20

WINDSHIELDS

Keep the elements out and control air flow into the cab.

POLARIS ENGINEERED ADVANTAGES

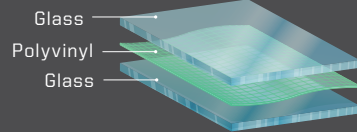

GLASS VS POLY

- Superior optical clarity (automotive level)
- Scratch-resistant
- Curved to fit, seals tight
- Cold weather / heavy duty
- Wiper ready (windshield only)

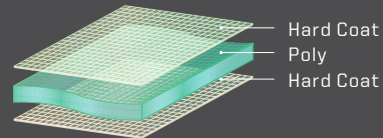

- Lightweight, flexible, easy to store/remove
- Impact-resistant
- Tight seal keeps out rain and dust
- Hard Coat: 30x more scratch resistance than regular poly windshields



LOCK & RIDE
REVOLUTIONARY
INSTALLATION



**AIRTIGHT
GASKET SEAL**

GLASS

HARD COAT POLY

POLY

TIP-OUT WINDSHIELD - GLASS TOP SELLER

» 2881108 • \$1,599⁹⁹

POLARIS GENERAL XP 1000/4 '20-22
POLARIS GENERAL 1000/4 '16-22

LOCK & RIDE FULL WINDSHIELD - GLASS TOP SELLER

» 2889064 • \$989⁹⁹

POLARIS GENERAL XP 1000/4 '20-22
POLARIS GENERAL 1000/4 '16-22

LOCK & RIDE VENTED WINDSHIELD - HARD COAT POLY

» 2884223 • \$789⁹⁹

POLARIS GENERAL XP 1000/4 '20-22
POLARIS GENERAL 1000/4 '16-22

LOCK & RIDE FLIP-DOWN WINDSHIELD - HARD COAT POLY

» 2889156 • \$749⁹⁹

POLARIS GENERAL XP 1000/4 '20-22
POLARIS GENERAL 1000/4 '16-22

LOCK & RIDE FULL WINDSHIELD - HARD COAT POLY

» 2884337 • \$679⁹⁹

POLARIS GENERAL XP 1000/4 '20-22
POLARIS GENERAL 1000/4 '16-22

LOCK & RIDE HALF WINDSHIELD - POLY

» 2881111 • \$269⁹⁹

POLARIS GENERAL XP 1000/4 '20-22
POLARIS GENERAL 1000/4 '16-22



WINDSHIELD WIPER & WASHER SYSTEM TOP SELLER

» 2881090 • \$739⁹⁹

POLARIS GENERAL XP 1000/4 '20-22
POLARIS GENERAL 1000/4 '16-22

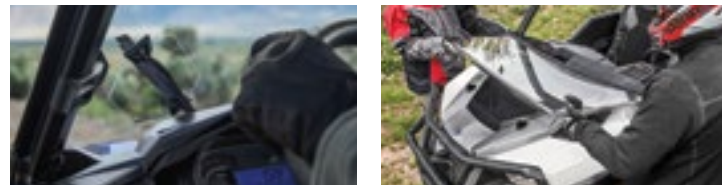

Offers fully-sealed or flipped-down venting options. Upper half detaches, leaving lower half for protection with maximum ventilation.

REAR PANELS

Turbulent air forms above the cargo bed and behind the cab when you add a windshield. This swirl can carry dirt, dust, leaves, and rain into the cab. Eliminate this phenomenon and **control the swirl** by installing a rear panel.



LOCK & RIDE REAR PANEL - GLASS TOP SELLER

» 2881113 • \$524⁹⁹

POLARIS GENERAL XP 1000/4 '20-22
POLARIS GENERAL 1000/4 '16-22



LOCK & RIDE REAR PANEL - POLY TOP SELLER

» 2881112 • \$489⁹⁹

POLARIS GENERAL XP 1000/4 '20-22
POLARIS GENERAL 1000/4 '16-22

ADD A REAR PANEL TO REDUCE
THE DUST SWIRL

DOORS

COMPLETE YOUR CAB. POLARIS GENERAL comes equipped with half doors. To create an enclosed cab for increased protection from the elements, choose from two great Polaris options.



REPLACE STOCK HALF DOORS

PREMIUM POLY FULL DOORS

- Impact and scratch-resistant tempered glass
- Fully-sealed design keeps elements out for a premium in-cab environment
- Hinged window adjustability
- Soft-touch, easy-to-clean premium interior liner

2-SEAT

- Six-way glass window adjustability

» 2883717 • **\$3,269⁹⁹**
POLARIS GENERAL XP 1000/4 '20-22
 POLARIS GENERAL 1000/4 '16-22

4-SEAT

- Push-out windows
- Kit includes B-pillar cover seal

» 2883082 • **\$3,469⁹⁹**
POLARIS GENERAL XP 4 1000 '20-22
 POLARIS GENERAL 4 1000 '17-22

ADD UPPER DOORS TO STOCK HALF DOORS

ZIP WINDOW UPPER DOORS

- Durable, rugged canvas stitched over a robust steel frame
- Lightweight, UV-resistant construction
- Retention straps for increased strength
- Zipper windows for increased venting options
- Mounts easily by drilling into stock doors (drill hole plugs included)

2-SEAT

» 2882548 • **\$1,099⁹⁹**
POLARIS GENERAL XP 1000 '20-22
 POLARIS GENERAL 1000 '18-22

NOT SHOWN

4-SEAT

» 2883453 • **\$2,039⁹⁹**
POLARIS GENERAL XP 4 1000 '20-22
 POLARIS GENERAL 4 1000 '18-22

POLARIS ENGINEERED ADVANTAGES



PREMIUM INTERIOR HANDLE AND LINER



A PERFECT FIT FOR THE PERFECT SEAL

SEE P. 14 FOR THE NEW RHINO-RACK® STORAGE SOLUTIONS

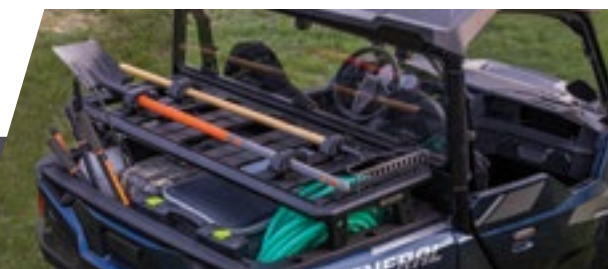

ROOFS

Protect yourself from the elements. The right roof shields you from the sun and driving rain.

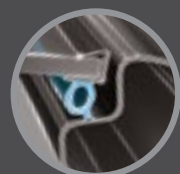

A PERFECT FIT FOR THE PERFECT SEAL

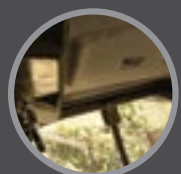

PREMIUM FEATURES & QUIETER RIDE



KEEP MOISTURE MOVING

POLARIS ENGINEERED ADVANTAGES

ALUMINUM VS POLY

- | | |
|--|---|
| <ul style="list-style-type: none"> • High protection strength • Lower profile • Sleek style | <ul style="list-style-type: none"> • Water run-off • Pre-existing mounting features • Liner ready • Lightweight |
|--|---|

2-SEAT

ROOF - ALUMINUM

» 2881105 • \$539⁹⁹
POLARIS GENERAL XP 1000 '20-22
POLARIS GENERAL 1000 '16-22



PREMIUM ROOF - POLY

» 2883800 • \$709⁹⁹
POLARIS GENERAL XP 1000 '20-22
POLARIS GENERAL 1000 '16-22



INCLUDES PREMIUM ROOF LINER

TOP SELLER SPORT ROOF - POLY

» 2883780 • \$459⁹⁹
POLARIS GENERAL XP 1000 '20-22
POLARIS GENERAL 1000 '16-22



4-SEAT

PREMIUM ROOF - POLY

» 2883801 • \$999⁹⁹
POLARIS GENERAL XP 4 1000 '20-22
POLARIS GENERAL 4 1000 '17-22



INCLUDES PREMIUM ROOF LINER

TOP SELLER SPORT ROOF - POLY

» 2883781 • \$764⁹⁹
POLARIS GENERAL XP 4 1000 '20-22
POLARIS GENERAL 4 1000 '17-22



POLY ROOF LINER

» 2883802 • \$339⁹⁹
POLARIS GENERAL XP 4 1000 '20-22
POLARIS GENERAL 4 1000 '17-22
Compatible with Sport Roof - Poly (2883781), sold separately



VEHICLE & RIDER PROTECTION

Arm your POLARIS GENERAL with Polaris Engineered bumpers and guards to take on any challenge. Engineered for easy, secure installation; providing added protection for lights, bodywork and suspension.



ROCK SLIDERS NOT SHOWN

LOW PROFILE

» 2881102 • \$379⁹⁹
POLARIS GENERAL 1000 '16-22
Not compatible with XL Fender Flares

EXTREME KICK-OUT

» 2-SEAT • 2881101 • \$409⁹⁹
POLARIS GENERAL XP 1000 '20-22
POLARIS GENERAL 1000 '16-22
» 4-SEAT • 2881992 • \$669⁹⁹
POLARIS GENERAL XP 4 1000 '20-22
POLARIS GENERAL 4 1000 '17-22

XL FENDER FLARES

» 2884220 • \$269⁹⁹
POLARIS GENERAL 1000/4 '16-22
Not compatible with Low Profile Rock Sliders
Standard on GENERAL XP models

HMW A-ARM GUARDS NOT SHOWN

» FRONT • 2880274 • \$269⁹⁹
POLARIS GENERAL XP 1000/4 '20-22
POLARIS GENERAL 1000/4 '16-22
» REAR • 2880171 • \$269⁹⁹
POLARIS GENERAL 1000 '16-22

HIGH CLEARANCE A-ARM GUARDS

» FRONT • 2884221 • \$269⁹⁹
POLARIS GENERAL XP 1000/4 '20-22
» REAR • 2884222 • \$269⁹⁹
POLARIS GENERAL XP 1000/4 '20-22

REAR SPORT BUMPER NOT SHOWN

» 2884345 • \$329⁹⁹
POLARIS GENERAL XP 1000/4 '20-22
POLARIS GENERAL 1000/4 '16-22

FRONT BUMPERS

» **SPORT LOW PROFILE** TOP SELLER
POLARIS GENERAL XP 1000/4 '20-22
POLARIS GENERAL 1000/4 '16-22
» 2881094 • \$339⁹⁹
POLARIS GENERAL XP 1000/4 '20-22
POLARIS GENERAL 1000/4 '16-22

SPORT UPPER

» 2881525 • \$339⁹⁹
POLARIS GENERAL XP 1000/4 '20-22
POLARIS GENERAL 1000/4 '16-22
Requires Sport Low Profile Front Bumper



EXPANSION ANCHOR MOUNTS

TOUGH EXPANSION ANCHOR MOUNTS DESIGNED FOR POLARIS GENERAL ALLOW FOR QUICK INSTALL OF ROCK SLIDERS AND BUMPERS WITHOUT DAMAGING THE VEHICLE'S FRAME.



STORAGE



BRING IT ALL. BRING IT ON.

From opposite sides of the globe, the most capable machines in the off-road world meet a trusted outdoor adventure brand to deliver industry-exclusive purpose-built bed racks and accessories to help Polaris GENERAL users have more fun and get more done. Increase storage capacity so you can go where you want with everything you need, organized to succeed.

REAR BED RACK



LOCK & RIDE **NEW** REAR BED RACK

- The ultimate modular load carrying solution
- Strong, lightweight aluminum construction tested in the harshest conditions
- Quickly adapt your vehicle from workday to weekend with a wide array of Rhino-Rack® attachments

» 2889443 • \$1,299⁰⁰

POLARIS GENERAL XP 1000/4 '20-22
POLARIS GENERAL 1000/4 '16-22

ATTACHMENTS



NEW GUN MOUNTING BRACKET

- Bracket used to mount Kolpin Stronghold Gun Boots to Rhino-Rack® systems when paired with Auto-Latch Mount (2884106), sold separately

» 2889327 • \$64⁰⁰

POLARIS GENERAL XP 1000/4 '20-22
POLARIS GENERAL 1000/4 '16-22

See P. 18 for more hunt information



NEW EYELET TIE-DOWNS

- Includes one set and hardware (straps not included) and attaches in multiple places on the platform to use as additional tie-down points
- Anti-corrosive galvanized steel for heavy-duty strength and long life

» 2889527 • \$73⁰⁰

POLARIS GENERAL XP 1000/4 '20-22
POLARIS GENERAL 1000/4 '16-22



NEW MULTI-PURPOSE TOOL HOLDER

- Carry and protect tools, paddles and more during your ride
- Ratchet-locking mechanism for quick release with rubber inserts to secure accessories into place

» 2889528 • \$104⁰⁰

POLARIS GENERAL XP 1000/4 '20-22
POLARIS GENERAL 1000/4 '16-22



NEW TRACTION BOARD MOUNT

- Strong, durable and easy to attach mount
- Traction board not included

» 2889530 • \$295⁰⁰

POLARIS GENERAL XP 1000/4 '20-22
POLARIS GENERAL 1000/4 '16-22



NEW CARGO CORNER BRACKET

- Bring a Northstar cooler or toolbox while saving space inside your vehicle
- Unique anti-rotation nut for maximum cargo security

» 2889531 • \$170⁰⁰

POLARIS GENERAL XP 1000/4 '20-22
POLARIS GENERAL 1000/4 '16-22



NEW HIGH LIFTING JACK MOUNT

- Installs simply and quickly with durable brackets
- Rugged, non-corrosive powder-coated steel stands up to the harshest conditions

» 2889533 • \$147⁰⁰

POLARIS GENERAL XP 1000/4 '20-22
POLARIS GENERAL 1000/4 '16-22



ACCESSORIES

WINDSHIELDS & REAR PANELS

DOORS

ROOFS & PROTECTION

STORAGE, CAB COMFORT & HUNT

COOLERS

CONNECTED TECHNOLOGY & AUDIO

LIGHTING

WHEELS & TIRES

WINCHES, PULWS & TRACKS

STORAGE



LOCK & RIDE
REAR BED STORAGE RACK

» 2885113 • \$1,034⁹⁹
POLARIS GENERAL XP 1000/4 '20-22
POLARIS GENERAL 1000/4 '16-22

See P. 18 for more info

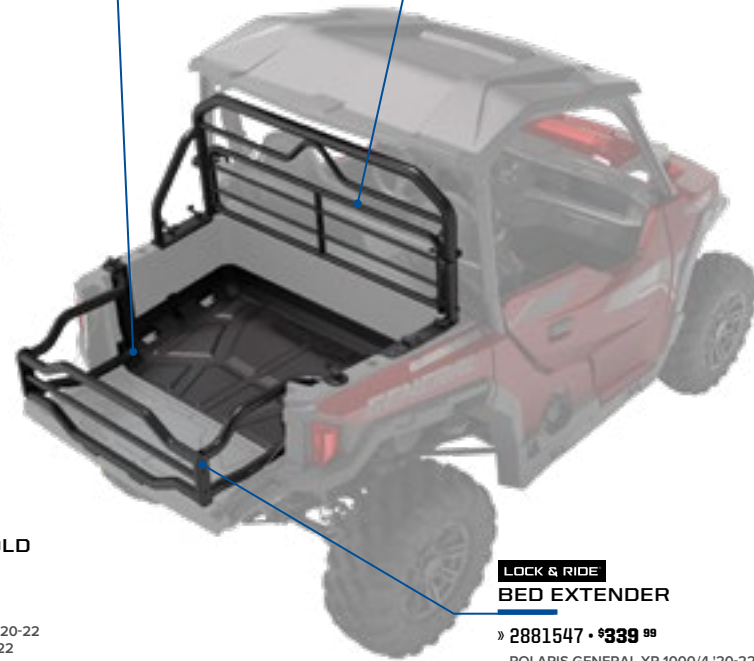

LOCK & RIDE
TIP-DOWN HEADACHE RACK

» 2882144 • \$469⁹⁹
POLARIS GENERAL XP 1000/4 '20-22
POLARIS GENERAL 1000/4 '16-22

CARGO BED MAT

» 2881933 • \$169⁹⁹
POLARIS GENERAL XP 1000/4 '20-22
POLARIS GENERAL 1000/4 '16-22

LOCK & RIDE
KOLPIN STRONGHOLD MOUNT

» 2885114 • \$83⁹⁹
POLARIS GENERAL XP 1000/4 '20-22
POLARIS GENERAL 1000/4 '16-22

See P. 18 for more info

LOCK & RIDE
BED EXTENDER

» 2881547 • \$339⁹⁹
POLARIS GENERAL XP 1000/4 '20-22
POLARIS GENERAL 1000/4 '16-22



LOCK & RIDE
SPARE TIRE CARRIER

» 2885122 • \$269⁹⁹
POLARIS GENERAL XP 1000/4 '20-22
POLARIS GENERAL 1000/4 '16-22

FITS WHEEL UP TO 30"



BEHIND SEAT STORAGE BAG

» 2882164 • \$94⁹⁹
POLARIS GENERAL XP 1000/4 '20-22
POLARIS GENERAL 1000/4 '16-22



IN-DASH STORAGE BAG

» 2882165 • \$64⁹⁹
POLARIS GENERAL XP 1000/4 '20-22
POLARIS GENERAL 1000/4 '16-22



LOCK & RIDE
CARGO BOX

» 2881527 • \$409⁹⁹
POLARIS GENERAL XP 1000/4 '20-22
POLARIS GENERAL 1000/4 '16-22
Includes all mounting hardware for secure installation



LOCK & RIDE
D-RINGS **TOP SELLER**

» 2881545 • \$43⁹⁹
POLARIS GENERAL XP 1000/4 '20-22
POLARIS GENERAL 1000/4 '16-22



FIRE EXTINGUISHER HOLDER **NOT SHOWN**

» 2882158 • \$114⁹⁹
POLARIS GENERAL XP 1000/4 '20-22
POLARIS GENERAL 1000/4 '16-22
Fits most 3.25" fire extinguishers (not included)

EASILY RECONFIGURE FOR ANY TASK OR ANY TRAIL

CAB COMFORT



8-VENT HEATER AND DEFROST SYSTEM **TOP SELLER**



» 2881316 • \$1,289⁹⁹
POLARIS GENERAL XP 1000/4 '20-22
POLARIS GENERAL 1000/4 '16-22

Not Compatible with Rockford Fosgate® Stage 4 Audio Kits
Audio Bracket (2885112) required to install heater on vehicles with RIDE COMMAND and audio, sold separately



WINDSHIELD WIPER AND WASHER SYSTEM **TOP SELLER**



» 2881090 • \$739⁹⁹
POLARIS GENERAL XP 1000/4 '20-22
POLARIS GENERAL 1000/4 '16-22

SEE P. 08 FOR WINDSHIELDS



CONVEX REAR VIEW MIRROR

» 2881540 • \$124⁹⁹
POLARIS GENERAL XP 1000/4 '20-22
POLARIS GENERAL 1000/4 '16-22



FLOOR MATS

» 2881934 • \$169⁹⁹
POLARIS GENERAL XP 1000/4 '20-22
POLARIS GENERAL 1000/4 '16-22



- Red light is great for reading maps
- Green light is perfect for navigating in the dark
- Blue light is ideal for night riding

MULTI-FUNCTION CAB LIGHT



- LED dome light provides white, red, green and blue lighting options
- Battery-operated, recharges when vehicle is on
- Remove to use as flashlight in and around vehicle

» 2884047 • \$134⁹⁹
POLARIS GENERAL XP 1000/4 '20-22
POLARIS GENERAL 1000/4 '19-22

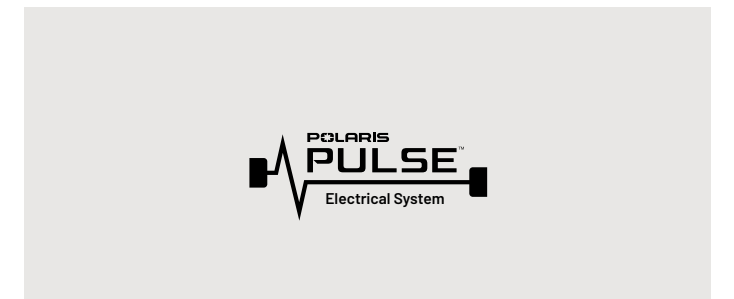

POLARIS PULSE LED LIGHT BAR HARNESS **TOP SELLER**



- Required to easily add electric components

» 2883785 • \$114⁹⁹
POLARIS GENERAL XP 1000/4 '20-22
POLARIS GENERAL 1000/4 '19-22

POLARIS ENGINEERED ADVANTAGES



ELECTRICAL INSTALLS MADE EASY WITH PLUG & PLAY



Look for to identify Polaris PULSE ready accessories.

- To install accessories, simply plug the harness into the Polaris PULSE hub
- No need to remove nuts and stack wire terminals like a three-post terminal setup
- By plugging in your accessories, a secure connection is guaranteed every time



PROTECTING YOUR ESSENTIAL GEAR SINCE 1943



STORAGE

LOCK & RIDE

REAR BED STORAGE RACK

- Take more gear with integrated MOLLE panels and Lock & Ride installation
- 30 or 60 Qt. Polaris coolers will still fit in bed with rack installed
- Compatible with (1) Kolpin Stronghold Mount

» 2885113 • \$1,034⁹⁹

POLARIS GENERAL XP 1000/4 '20-22
POLARIS GENERAL 1000/4 '16-22

LOCK & RIDE

KOLPIN STRONGHOLD MOUNT

- Kolpin Stronghold mount for attaching gun boots or other Kolpin Stronghold items to a General Rear Bed Storage Rack

» 2885114 • \$83⁹⁹

POLARIS GENERAL XP 1000/4 '20-22
POLARIS GENERAL 1000/4 '16-22

KOLPIN STRONGHOLD CASES & MOUNT



KOLPIN STRONGHOLD GUN BOOT XL

- Includes zippered internal liner
- Lockable

» 2882036* • \$109⁹⁹

POLARIS GENERAL XP 1000/4 '20-22
POLARIS GENERAL 1000/4 '16-22



KOLPIN STRONGHOLD GUN BOOT L

» 2882426* • \$83⁹⁹

POLARIS GENERAL XP 1000/4 '20-22
POLARIS GENERAL 1000/4 '16-22



KOLPIN STRONGHOLD AUTO-LATCH MOUNT

» 2884106 • \$83⁹⁹

POLARIS GENERAL XP 1000/4 '20-22
POLARIS GENERAL 1000/4 '16-22



KOLPIN STRONGHOLD AUTO-LATCH DOUBLE GUN BOOT MOUNT

» 2883970 • \$234⁹⁹

POLARIS GENERAL XP 1000/4 '20-22
POLARIS GENERAL 1000/4 '16-22



NEW GUN MOUNTING BRACKET

- Bracket used to mount Kolpin Stronghold Gun Boots to Rhino-Rack® systems when paired with Auto-Latch Mount (2884106), sold separately

» 2889327 • \$64⁹⁹

POLARIS GENERAL XP 1000/4 '20-22
POLARIS GENERAL 1000/4 '16-22

See P. 14 for more Rhino-Rack® products

RHINO-RACK® MOUNT

KOLPIN RHINO GRIPS

IDEAL FOR BOWS & UNCASSED GUNS



LOCK & RIDE

RHINO GRIP PRO

» 2884107 • \$109⁹⁹

POLARIS GENERAL XP 1000/4 '20-22
POLARIS GENERAL 1000/4 '16-22



NEW

LOCK & RIDE

RHINO GRIP XLR

» 2881574 • SINGLE • \$62⁹⁹

POLARIS GENERAL XP 1000/4 '20-22
POLARIS GENERAL 1000/4 '16-22



RHINO GRIP XLR REPLACEMENT RUBBER STRAPS (2)

» 2889204 • \$11⁹⁹

POLARIS GENERAL XP 1000/4 '20-22,
POLARIS GENERAL 1000/4 '16-22



LOCK & RIDE

RATCHETING RHINO GRIP

» 2881575 • \$90⁹⁹

POLARIS GENERAL XP 1000/4 '20-22
POLARIS GENERAL 1000/4 '16-22



NEW

LOCK & RIDE

RHINO GRIP XLR - DOUBLES

» 2889166 • \$94⁹⁹

POLARIS GENERAL XP 1000/4 '20-22
POLARIS GENERAL 1000/4 '16-22



RHINO GRIP PRO REPLACEMENT RUBBER STRAPS (2)

» 2884109 • \$11⁹⁹

POLARIS GENERAL XP 1000/4 '20-22,
POLARIS GENERAL 1000/4 '16-22

KEEP IT
ICE COLD

GRIZZLY TESTED.
POLARIS APPROVED.



This cooler is IGBC-approved, meaning it withstands the power expended by a typical grizzly bear if it was trying to get inside.

Seriously, there are experts who know what a grizzly is capable of doing, and they certify our coolers can take it.



30, 60 & 105
QUART FEATURES



ComfortCarry
Handles



TravelLock
System



EasyOut
Drain System



NoSlip
Rubber Feet



PolarWall
Insulation



IceLock
Seal

POLARIS NORTHSTAR COOLERS CAN SURVIVE JUST ABOUT ANYTHING - FROM EXTREME HEAT TO A NASTY TUMBLE OFF A VEHICLE.



105 QUART

- » GRAPHITE • 2883426 • \$509⁹⁹
- » DESERT • 2883392 • \$509⁹⁹



60 QUART

- » GRAPHITE • 2883425 • \$409⁹⁹
- » DESERT • 2881259 • \$409⁹⁹



30 QUART

- » GRAPHITE • 2883424 • \$309⁹⁹
- » DESERT • 2881315 • \$309⁹⁹



15 QUART

- » GRAPHITE • 2883968 • \$249⁹⁹



NEW
20 QUART SOFT-SIDED COOLER

- » GRAPHITE • 2889285 • \$219⁹⁹

HOLDS ICE
30+
HOURS
LONGER
THAN YETI^{®*}

*YETI is a registered trademark of YETI COOLERS, LLC

ESSENTIAL ACCESSORIES SO YOUR COOLER WORKS AS HARD AS YOU DO

COOLER ACCESSORIES	105 QUART	60 QUART	30 QUART	DON'T FORGET THESE ACCESSORIES	
<p>WIRE BASKET</p>	2883648 • \$59 ⁹⁹	2882185 • \$43 ⁹⁹	2882438 • \$36 ⁹⁹	<p>TUMBLERS</p> <ul style="list-style-type: none"> » 30 OZ • 2883394 • \$36⁹⁹ » 20 OZ • 2883393 • \$30⁹⁹ 	<p>LOCK & RIDE QUICKSTRAP</p> <ul style="list-style-type: none"> » 2882187 • \$59⁹⁹ ALL COOLERS AND POLARIS GENERAL CARGO BOXES
<p>DIVIDERS Doubles as cutting board</p>	2883468 • \$43 ⁹⁹ COMES WITH ONE DIVIDER 	2882184 • \$59 ⁹⁹ COMES WITH TWO DIVIDERS 	2882186 • \$30 ⁹⁹ COMES WITH ONE DIVIDER 		
<p>SEAT CUSHION</p>	NOT AVAILABLE	2882179 • \$114 ⁹⁹	2882507 • \$89 ⁹⁹		
<p>WHEELS</p>	2883967 • \$119 ⁹⁹	2882180 • \$124 ⁹⁹	NOT AVAILABLE	<p>BOTTLE OPENER</p> <ul style="list-style-type: none"> » 2882183 • \$15⁹⁹ ALL COOLERS 	

CONNECTED TECHNOLOGY

POLARIS RIDECOMMAND



PLAN. TRACK. SHARE. CONNECT.

PLAN YOUR RIDE

Plan an epic ride with stops along the way, customize and adjust your path to maximize your route or follow turn-by-turn directions. You can even share your planned route with friends.

FOLLOW THE GROUP

With Group Ride, you can ride at your own speed and keep fellow riders in sight on your map screen, even if you get split up. Because rides are meant to be shared.

DISCOVER NEW TRAILS

With almost 1,000,000 miles of trails available offline, you'll have the confidence to explore further, whether you have cellular coverage or not.

RELIVE YOUR RIDE

With 3D flyovers you can track and go over your completed rides, and share your favorite routes with friends even after the ride is over.

TRAIL TECH



VOYAGER PRO

ADD ANY VEHICLE TO YOUR POLARIS GROUP RIDES

The Trail Tech Voyager Pro GPS seamlessly connects with 2020-2022 Polaris RIDE COMMAND 7" Displays. Join the group and ride.

THE CONNECTED RIDER'S GPS

Featuring Polaris Group Ride compatibility, custom maps, Bluetooth®, a 4" color touchscreen and full vehicle integration with gauges. Model-specific kits available for all UTV, ATV, snow and motorcycle brands.

7" DISPLAY POWERED BY RIDE COMMAND



- Bright, 7" touchscreen visible in all conditions
- **GPS Navigation & Pre-Loaded Maps**
Available offline on the in-dash display so you always know where you are.
- **Route Planning**
Add points of interest and waypoints to make the most of your off-road adventure.
- **Group Ride**
"Follow the Leader" lets you set and follow the group leader on your display. Group Ride Messaging, lets you send messages to your group with or without a cellular signal.

- **Camera Integration**
Navigate with full view of your surroundings. Use the integrated rear camera to see others behind you while riding.
- **Personalized Audio Experience**
Seamlessly pair your display via Bluetooth® to wirelessly stream music and stay connected with call and text alerts.
- **Configurable Gauges**
Customize your ride experience with elevation, travel direction, fuel level and more to create relevant screens for you.

» 2884072 • \$1,999⁹⁹
POLARIS GENERAL XP 1000/4 '20-22
POLARIS GENERAL 1000/4 '19-22

7" DISPLAY MOUNT KIT



- Mount RIDE COMMAND seamlessly into the dash for perfect fit and finish
 - Comes with required wiring harnesses and accessory components
 - Includes front and rear camera, V2V and GPS antenna
- » 2889338 • \$649⁹⁹
POLARIS GENERAL XP 1000/4 '20-22
POLARIS GENERAL 1000/4 '20-22
WHEN REPLACING FACTORY IN-DASH AUDIO: EITHER AMP (2414533) AND RELOCATION KIT (2885112), BOTH REQUIRED SOLD SEPARATELY -OR- STAGE 3 RIDE COMMAND AUDIO KIT & REAR SPEAKERS (2885163), SOLD SEPARATELY, ARE REQUIRED

AUDIO BRACKET

- Used to mount audio amplifier for front and rear speakers when subwoofer is removed
 - Required to install a heater on a vehicle with RIDE COMMAND and audio
- » 2885112 • \$64⁹⁹
POLARIS GENERAL XP 1000/4 '20-22
POLARIS GENERAL 1000/4 '20-22

VOYAGER PRO KIT, UTV

- Bright, 4" touchscreen visible in all conditions
- **Pre-Loaded Base Maps**
The map screen is enabled with base maps, topography lines, hill shading and select trails. Record or load GPS trails/riding areas and transfer to a PC.
- **Buddy Tracking**
Track up to 20 group members no matter what type of vehicle they are riding.

- **Bluetooth® Enabled**
Bluetooth® enabled for intercom, phone and media controls. Play songs from your phone or MicroSD card using a Bluetooth® headset, speaker or intercom. Two phones and two headsets can be connected at the same time.

» 922-125 • \$779⁹⁹
AVAILABLE AT YOUR LOCAL DEALER OR ONLINE AT TRAILTECH.NET



LEARN MORE AND DOWNLOAD AT
RIDECOMMAND.POLARIS.COM



LEARN MORE AT
TRAILTECH.NET



@RIDETRAILTECH

AUDIO



PLUG AND PLAY



ELEMENT READY™



NO LOSS OF CARGO SPACE



BLUETOOTH™ CAPABLE

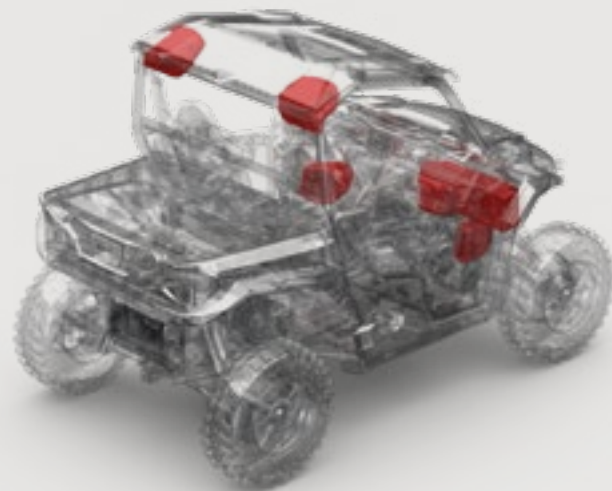

An industry first. A true factory installed integrated off-road audio system. Rockford Fosgate® partnered with Polaris to purpose build the highest performing system specifically for the GENERAL platform. Tuned and rider-centric to create a class leading audio experience that is second to none.



TOP SELLER
STAGE 1 AUDIO KIT

- PMX-P2 HEAD UNIT & FRONT COAXIAL SPEAKERS & ANTENNA
- 2.7" full color display with AM/FM/WB tuner, Pandora® Control and Bluetooth™ Connectivity
- 50 Watt 6.5" front coaxial speakers with enclosures and grilles

» 2884282 • \$1,034 ⁹⁹

POLARIS GENERAL XP 1000/4 '20-22
POLARIS GENERAL 1000/4 '20-22



STAGE 3 PMX AUDIO KIT + REAR SPEAKERS

- REAR COAXIAL SPEAKERS & AMP
- 2, 50 Watt 6.5" rear coaxial speakers with enclosures and grilles
- 400 Watt 4-channel full range amplifier
- IP67 Rating delivering water resistance and dust protection

» 2885162 • \$899 ⁹⁹

POLARIS GENERAL XP 1000/4 '20-22
POLARIS GENERAL 1000/4 '16-22



TOP SELLER
STAGE 3 RIDE COMMAND AUDIO KIT + REAR SPEAKERS

- FRONT & REAR COAXIAL SPEAKERS, ANTENNA & AMP
- 2, 50 Watt 6.5" front and rear coaxial speakers with enclosures and grilles
- 400 Watt 4-channel full range amplifier
- IP67 Rating delivering water resistance and dust protection

» 2885163 • \$969 ⁹⁹

POLARIS GENERAL XP 1000/4 '20-22
POLARIS GENERAL 1000/4 '16-22
REQUIRES 7" DISPLAY WITH RIDE COMMAND (2884072) & 7" DISPLAY MOUNT KIT (2884283), BOTH SOLD SEPARATELY



NEW
STAGE 4 UPGRADE

- POWERED SUBWOOFER
- Compatible with Stage 1 and Stage 2 PMX-P2 Audio Kits
- 400 Watt 10" subwoofer
- Compatible with Stage 1 and Stage 3 Audio Kits

» 2889306 • \$709 ⁹⁹

POLARIS GENERAL XP 1000/4 '20-22
POLARIS GENERAL 1000/4 '16-22
NOT COMPATIBLE WITH HEATER KIT (2881316)

BUILD YOUR SOUND

HEAD UNIT:	PMX-P2		RIDE COMMAND
AUDIO:	STAGE 1 AUDIO KIT	STAGE 3 + 4 UPGRADES	STAGE 3 RIDE COMMAND AUDIO KIT
MODEL FITMENT:			
XP	STAGE 1 AUDIO KIT WITH PMX-P2 HEAD UNIT INSTALLED	STAGE 3 + REAR SPEAKERS UPGRADE REAR SPEAKERS, AMP + AUDIO BRACKET 2885162 • \$899 ⁹⁹	RIDE COMMAND + STAGE 3 AUDIO SYSTEM BY ROCKFORD FOSGATE® MODEL INSTALLED
DELUXE			TO ADD 8-VENT HEATER & DEFROST SYSTEM (2881316), SUBWOOFER MUST BE REMOVED AND AMP RELOCATION BRACKET (2885112) MUST BE INSTALLED
PREMIUM		OPTIONAL SUBWOOFER	
SPORT	STAGE 1 AUDIO KIT PMX HEAD UNIT + FRONT COAXIAL SPEAKERS + ANTENNA 2884282 • \$1,034 ⁹⁹	STAGE 4 UPGRADE SUBWOOFER 2889306 • \$709 ⁹⁹	7" DISPLAY WITH RIDE COMMAND 2884072 • \$1,999 ⁹⁹ + 7" DISPLAY MOUNT KIT 2889338 • \$649 ⁹⁹ 2020-2022 MODELS + STAGE 3 UPGRADE REAR SPEAKERS, AMP + AUDIO BRACKET 2885163 • \$969 ⁹⁹ + STAGE 4 UPGRADE SUBWOOFER 2889306 • \$709 ⁹⁹ NOT COMPATIBLE WITH 8-VENT HEATER & DEFROST SYSTEM (2881316)



POLARIS ENGINEERED ADVANTAGES

MOUNTS PERFECTLY
Designed for your Polaris Engineered bumper, roof or other mounting point

MAX PERFORMANCE
Validated to work as hard as your machine does

DOESN'T OVERTAX
Trust it to work when you need it to

PRO ARMOR



ADVANCED TECH

RIGID® lights are driven by Aluminum PCB Smart Boards™, 6063-T5 aircraft aluminum extruded housings and Tiger Drylac® UV protection polyester powdercoating.

EXCLUSIVE OPTICS

RIGID® invests heavily in optical science and has patented multiple optics and optics systems, maximizing light output and efficiency.

RIGID® LIMITED LIFETIME WARRANTY

If you own a RIGID® light and it breaks, we will replace or repair it for life.*

RUGGED CONSTRUCTION

Pro Armor lights are designed to be big and beefy with an aggressive style all their own, and housed in IP67 marine-grade rated UV polyester powdercoating.

MASSIVELY BRIGHT

Pro Armor builds bright lights designed for any riding experience. All that power is directed through heat dissipating aluminum for streamlined heat management.

LIGHT BAR TYPES



SR-SERIES PRO

Sleek, powerful, low-profile (under 2" tall). Lights extreme distances with low energy usage.
Available in 10" & 32"



D-SERIES PRO

Compact to fit almost anywhere with high output and low energy usage.
Available in Driving, Flood & Spot



DUAL-ROW LED LIGHT BARS

The most spread and farthest illumination downrange. Easy to mount.
Available in Cube, 10", 20" & 30"



SINGLE-ROW LED LIGHT BARS

Powerful, compact, low-profile light bars with sleek look.
Available in 11", 33" & 40"



CUBE LED LIGHTS

Small size allows mounting in strategic locations for added lighting.
Available in Flood & Spot

LIGHT BAR OPTIONS

SHOP & VERIFY VEHICLE FITMENT AT POLARIS.COM/ShopGENERAL

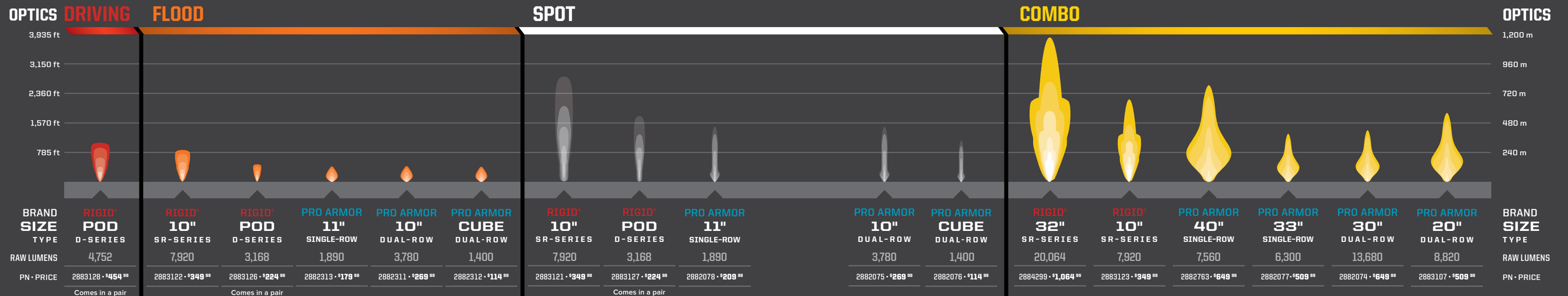

BUILD YOUR VISION

Consider the optics, angle & how you will use your vehicle to choose the right light or set of lights.

OPTICS LIGHT ANGLE	ACCENT	DRIVING (45°)	FLOOD (25°)	SPOT (10°)	COMBO (25°/10°)
DRIVING SPEED	All	Slow	Medium	Fast	Medium to fast
BEAM	Diffused glow	Extra-wide	Wide/shorter	Concentrated/long	Inner spot & outer flood
RECOMMENDED MOUNTING	Low/wheel well	All points	Low &/or rear	High points	All points
TERRAIN & RIDING STYLE	Added style & personalization in any terrain	All riding & utility	Wide-open terrain or trails & utility	Trail & tight conditions	All riding & utility

COMPARE LIGHTS IN A REAL WORLD SETTING AT POLARIS.COM/LIGHTING

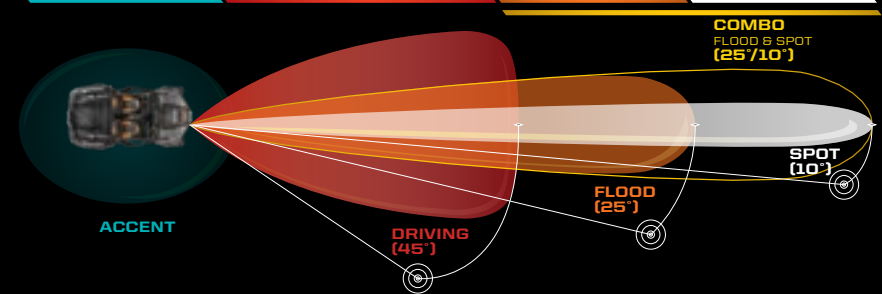

ADD A HARNESS TO MOUNT YOUR LIGHTS

MODEL	LIGHT BAR SET-UPS		
	1 LIGHT IN 1 LOCATION ON 1 SWITCH	2 LIGHTS IN 2 LOCATIONS ON 1 SWITCH	2 LIGHTS IN 2 LOCATIONS ON 2 SWITCHES
2019-2022 ALL MODELS	TOP SELLER POLARIS PULSE LED LIGHT BAR HARNESS 2883785 · \$114 ⁹⁹	TOP SELLER POLARIS PULSE LED LIGHT BAR HARNESS 2883785 · \$114 ⁹⁹ Y-HARNESS 2879860 · \$23 ⁹⁹	TOP SELLER POLARIS PULSE LED LIGHT BAR HARNESS (x2) 2883785 · \$114 ⁹⁹

⚠ No battery connection cables required on any model/model year POLARIS GENERAL 1000.

All RIGID® and Pro Armor lights are Polaris PULSE ready.

ACCENT LIGHTING

ACCENT LIGHTS

POLARIS GENERAL XP 1000/4 '20-22
POLARIS GENERAL 1000/4 '16-22

COLOR	PN	PRICE
RED (SET OF 4)	2880500	\$209 ⁹⁹
BLUE (SET OF 4)	2880506	\$209 ⁹⁹

* If RIGID® determines, in its sole discretion, that your product is defective in material or workmanship, RIGID® will honor your warranty claim. In some cases the product will be replaced, depending on the specific timeframe of the purchase. If the product is repaired, all parts, labor, and return shipping may be covered by RIGID®.

ACCESSORIES

WINDSHIELDS & REAR PANELS

DOORS

ROOFS & PROTECTION

STORAGE, CAB COMFORT & HUNT

COOLERS

CONNECTED TECHNOLOGY & AUDIO

LIGHTING

WHEELS & TIRES

WINCHES, PLOW & TRACKS

KNOW YOUR TERRAIN



- Tread patterns optimized for extreme traction
- Ideal for both hard pack and loose trail



- Flexible "grippy" tread
- Aggressive side bite



- Provides traction and durability
- Built to perform in hard sand, jagged rocks or any other extreme terrain



- Extra deep treads
- Self-cleaning lugs



- Paddles provide traction and durability in soft sand
- Built to float on top of sand



- Triple-belted sidewalls to resist puncture
- Purpose-built, long lasting tread patterns



- Handles extreme cold
- Holds shape and provides traction

SUPERIOR PERFORMANCE & DURABILITY

WAYS TO SHOP WHEELS & TIRES



LIFELONG PERFORMANCE

- Every tire is designed and constructed with longevity in mind
- 3,000+ mile rated (4,828 kilometers)

PREMIUM PROTECTION

- Pro Armor makes tires with extra protection exactly where it's needed most – the sidewall
- Triple-belted sidewalls keep your tires more resistant so you can keep going

TOUGH TIRES

- Higher ply ratings mean added protection
- Pro Armor builds 8 or 10-ply rated tires for higher puncture-resistance



KNOW YOUR TIRES

DIMENSIONS			TREAD DEPTH	TIRE WEIGHT	PLY RATING	SIDEWALL BELTS	LOAD RATING
TIRE HEIGHT	TIRE WIDTH	WHEEL DIAMETER					
32" x 9"	R15	FRONT/REAR	30 mm	41 lbs	10	3	1,320 lbs
Part Number • Price							
USAGE Where can you use the tire			TREAD DEPTH Deeper treads have more grip in all conditions	TIRE WEIGHT A lighter tire makes for improved vehicle performance	PLY RATING Indicates tire puncture-resistance	SIDEWALL BELTS Increase your resistance to sidewall punctures	LOAD RATING How much weight can the tire handle

TIRES BY SIZE

26"	27"	28"	29"	30"
ATTACK	MUD XC	HARVESTER	DUAL-THREAT	CRAWLER XG
DUAL-THREAT	HARVESTER	CRAWLER XR	MUD XC	ATTACK 2.0
HARVESTER		ATTACK 2.0	HD-K	HARVESTER
XD-K		CRAWLER XG		CRAWLER XR
				CRAWLER AT

TIRES BY TERRAIN

TRAIL	ROCK	DESERT	MUD	UTILITY	SNOW
CRAWLER XR	CRAWLER XR	CRAWLER XR	MUD XC	HARVESTER	ATTACK 2.0
CRAWLER XG	CRAWLER XG	CRAWLER XG		HD-K	ATTACK
MUD XC	DUAL-THREAT	ATTACK 2.0		XD-K	HARVESTER
ATTACK 2.0	ATTACK 2.0	ATTACK			XD-K
ATTACK	CRAWLER AT	DUAL-THREAT			HD-K
DUAL-THREAT		CRAWLER AT			
HARVESTER					
XD-K					
HD-K					
CRAWLER AT					

WHEELS BY SIZE

14"	15"
40-SERIES (14 TIRE OPTIONS)	50-SERIES (6 TIRE OPTIONS)
4201	5201
4202	5202
4203 BEADLOCK	5203 BEADLOCK
4204	5301 BEADLOCK
4205	
4301 BEADLOCK	
HD DUAL BEADLOCK	

KNOW YOUR WHEELS

STEP 1: SELECT YOUR SERIES

4 = 40-SERIES 5 = 50-SERIES

STEP 2: CHOOSE YOUR LOAD RATING

1 = <800 LBS 2 = 801 - 1,300 LBS 3 = 1,301 - 1,600+ LBS

STEP 3: PICK YOUR STYLE

OFFSET / BEADLOCK / COLOR

INCREASE OFFSET FROM STOCK = NARROWER STANCE
DECREASE OFFSET FROM STOCK = WIDER STANCE

TIRES



PRO ARMOR CRAWLER XR

- Premium grip for all terrains, from the trail to the rocks
- Square block profile for even surface contact
- A tougher durometer than the XG to take on the toughest the trail has to offer

	TREAD DEPTH	TIRE WEIGHT	PLY RATING	SIDEWALL BELTS	LOAD RATING
14" 28" x 10" R14 5415536 • \$209 ⁹⁹	FRONT/REAR 16 mm	32 lbs	8	3	1,140 lbs



WHAT CRAWLER ARE YOU?

XR

SINGLE DUROMETER

- Smaller lug height, added rigidity and lateral stability when cornering
- Unique lug design excels in hard pack, fast terrain



PRO ARMOR ATTACK 2.0

- Engineered for excellent hard pack performance
- Dual-compound technology and radial construction offer performance in all terrains
- Tight thread pattern for a quieter ride

	TREAD DEPTH	TIRE WEIGHT	PLY RATING	SIDEWALL BELTS	LOAD RATING
15" 28" x 10" R15 5416344 • \$269 ⁹⁹	FRONT/REAR 25 mm	32 lbs	10	3	1,110 lbs
15" 30" x 10" R15 5416345 • \$299 ⁹⁹		38 lbs			1,235 lbs



TIGHTER TREAD PATTERN =
Better traction in hard pack

DUAL-DUROMETER LUG =
Increased grip & traction in rough terrain, smoother ride in all terrain

10-PLY RATED =
Increased durability

LARGER 28" & 30" SIZE OFFERING =
More ground clearance & trail traction



PRO ARMOR CRAWLER XG

- Built to crawl over all obstacles, both large and small
- A soft, sticky compound makes this tire ideal for both rock crawling and desert running
- 8-ply, triple-belted ballistic sidewalls resist punctures

	TREAD DEPTH	TIRE WEIGHT	PLY RATING	SIDEWALL BELTS	LOAD RATING
14" 30" x 10" R14 5415616 • \$249 ⁹⁹	FRONT/REAR 20 mm	38 lbs	8	3	1,280 lbs
15" 28" x 10" R15 5416346 • \$269 ⁹⁹		33 lbs			1,100 lbs
15" 30" x 10" R15 5416397 • \$299 ⁹⁹		39 lbs			1,280 lbs



XG

DUAL-DUROMETER

- Taller lug height and dual-durometer construction
- Perfect balance between high-speed performance, durability and flex in order to grip slick rock



PRO ARMOR ATTACK

- The best all-purpose tire for all-season traction in any terrain
- Unique, full-face tread design
- Harder durometer lugs promote extended wear, increasing tire life
- Wider spaced lugs provide more grip in softer terrain

	TREAD DEPTH	TIRE WEIGHT	PLY RATING	SIDEWALL BELTS	LOAD RATING
14" 26" x 9" R14 5415613 • \$189 ⁹⁹	FRONT/REAR 23 mm	28 lbs	8	3	910 lbs
14" 26" x 11" R14 5415614 • \$209 ⁹⁹		32 lbs			1,320 lbs



PRO ARMOR CRAWLER AT

- Directional tread for optimum performance
- Greater lug separation for easy mud clean out
- 8-ply, triple-belted ballistic sidewalls resist punctures

	TREAD DEPTH	TIRE WEIGHT	PLY RATING	SIDEWALL BELTS	LOAD RATING
15" 30" x 10" R15 5417534 • \$299 ⁹⁹	FRONT/REAR 18 mm	36 lbs	8	3	1,280 lbs



AT

DIRECTIONAL LUG PATTERN

- The same taller lug height as Crawler XG, providing more grip and better traction
- Wider lug spacing for excellent mud clean-out



PRO ARMOR DUAL-THREAT

- Dual-compound technology and radial construction offer performance in all terrains
- Softer durometer rubber on outer edge for overall superior grip and feel
- Harder durometer rubber in the middle for increased traction during acceleration and longer tread life

	TREAD DEPTH	TIRE WEIGHT	PLY RATING	SIDEWALL BELTS	LOAD RATING
14" 26" x 9" R14 5416340 • \$219 ⁹⁹	FRONT/REAR 16 mm	27 lbs	10	3	910 lbs
14" 26" x 11" R14 5416341 • \$229 ⁹⁹		30 lbs			1,110 lbs
14" 29" x 9" R14 5416342 • \$269 ⁹⁹		30 lbs			1,110 lbs
14" 29" x 11" R14 5416343 • \$279 ⁹⁹		35 lbs			1,320 lbs

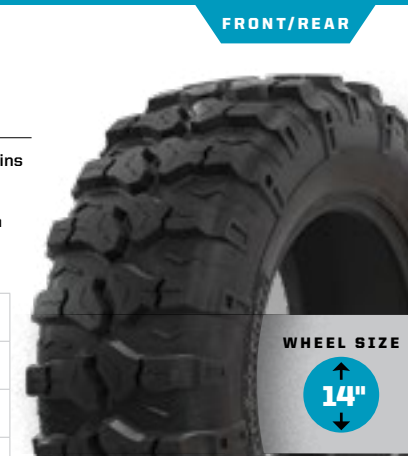

DUAL-COMPOUND = MORE GRIP + LONGER LIFE

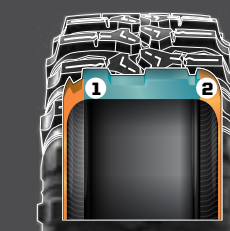

- 1 Firmer Durometer Rubber = Longer Life
- 2 Softer Durometer Rubber = More Grip

ACCESSORIES

WINDSHIELDS & REAR PANELS

DOORS

ROOFS & PROTECTION

STORAGE, CAB COMFORT & HUNT

COOLERS

CONNECTED TECHNOLOGY & AUDIO

LIGHTING

WHEELS & TIRES

WINCHES, PLYWS & TRACKS

31

TIRES



PRO ARMOR MUD XC

- Designed as the perfect mud-trail crossover for a smooth ride on the trail and aggressive traction in the mud
- Dual-compound technology with harder durometer lugs promote extended wear, increasing tire life
- 10-ply construction means added protection in the toughest terrain

		TREAD DEPTH	TIRE WEIGHT	PLY RATING	SIDEWALL BELTS	LOAD RATING
14"	27" x 9" R14 5416947 • \$249 ⁹⁹	FRONT	30 lbs			1,170 lbs
14"	27" x 11" R14 5416948 • \$259 ⁹⁹	REAR	30 mm	10	3	1,320 lbs
14"	29" x 10" R14 5416946 • \$269 ⁹⁹	FRONT/REAR	39 lbs			1,390 lbs



FRONT/REAR

WHEEL SIZE

14"



PRO ARMOR HARVESTER

- All-around work horse with tread life of 5,000 miles / 8047 km
- Tread pattern designed to withstand anything from the farmyard to the pastures and the trail
- With 10-ply, it can carry the load day in and day out

		TREAD DEPTH	TIRE WEIGHT	PLY RATING	SIDEWALL BELTS	LOAD RATING
12"	26" x 8" R12 5416396 • \$229 ⁹⁹	FRONT	24 lbs			855 lbs
12"	26" x 10" R12 5415966 • \$249 ⁹⁹	REAR	32 lbs			1,355 lbs
14"	27" x 10" R14 5415965 • \$249 ⁹⁹	FRONT/REAR	16 mm	10	3	1,320 lbs
14"	28" x 10" R14 5416347 • \$269 ⁹⁹	FRONT/REAR	34 lbs			1,390 lbs
15"	30" x 10" R15 5417529 • \$299 ⁹⁹	FRONT/REAR	37 lbs			1,320 lbs



FRONT/REAR

WHEEL SIZE

12" 14" 15"



PICKING THE RIGHT UTILITY TIRE

UTILITY FEATURE	HARVESTER	XD-K	HD-K
5,000 Mile / 8,047 Kilometer Rated Long life and performance	X		
10-Ply Rated Higher ply ratings means added protection	X	X	X
Heavy Duty Tread Aggressive tread pattern for all day work on farms or ranches	X	X	X
Turf-Friendly Easy on grass and farm yard	X		
Aramid Fiber Belt 5x times stronger than steel and lighter		X	X
Size Options For exactly how you want to use your machine	26", 27", 28", 30"	26"	29"



PRO ARMOR XD-K

- 26" Aramid fiber-belted tire to tackle any terrain
- Unique full-face tread design
- Harder durometer lugs promotes extended wear, increasing tire life

		TREAD DEPTH	TIRE WEIGHT	PLY RATING	SIDEWALL BELTS	LOAD RATING
12"	26" x 9" R12 5415756 • \$278 ⁹⁹	FRONT	28 lbs			855 lbs
12"	26" x 11" R12 5415757 • \$293 ⁹⁹	REAR	31.7 mm	10	3/1 Aramid	1,100 lbs



FRONT/REAR

WHEEL SIZE

12"



PRO ARMOR HD-K

- Designed to provide a smooth ride and aggressive traction in all riding terrains
- Triple-belted sidewall provides extreme protection and extends the tire life
- Quad belt tread core offers superior protection and longer tread life

		TREAD DEPTH	TIRE WEIGHT	PLY RATING	SIDEWALL BELTS	LOAD RATING	
14"	29" x 10" R14 5417507 • \$439 ⁹⁹	FRONT/REAR	31.75 mm	40 lbs	10	3/1 Aramid	1,320 lbs



FRONT/REAR

WHEEL SIZE

14"

ACCESSORIES

WINDSHIELDS & REAR PANELS

DOORS

ROOFS & PROTECTION

STORAGE CAB COMFORT & HUNT

COOLERS

CONNECTED TECHNOLOGY & AUDIO

LIGHTING

WHEELS & TIRES

WINCHES, PLOWS & TRACKS

WHEELS



40-SERIES

A 4201 
 FRONT WEIGHT: 13 lbs | LOAD RATING: 900 lbs | OFFSET: +4
 REAR WEIGHT: 14 lbs | LOAD RATING: 1,300 lbs | OFFSET: -9
 ACCENT: FRONT 14" x 7" 1522956-266 **\$189**⁹⁹
 REAR 14" x 8" 1522957-266 **\$209**⁹⁹
 MATTE BLACK: FRONT 14" x 7" 1522956-458 **\$169**⁹⁹
 REAR 14" x 8" 1522957-458 **\$179**⁹⁹

B 4202 
 FRONT WEIGHT: 12.75 lbs | LOAD RATING: 900 lbs | OFFSET: +4
 REAR WEIGHT: 13.5 lbs | LOAD RATING: 1,300 lbs | OFFSET: -9
 ACCENT: FRONT 14" x 7" 1522544-266 **\$189**⁹⁹
 REAR 14" x 8" 1522545-266 **\$209**⁹⁹
 MATTE BLACK: FRONT 14" x 7" 1522544-458 **\$169**⁹⁹
 REAR 14" x 8" 1522545-458 **\$179**⁹⁹

C 4203 BEADLOCK 
 FRONT WEIGHT: 13 lbs | LOAD RATING: 900 lbs | OFFSET: +4
 REAR WEIGHT: 14.5 lbs | LOAD RATING: 1,300 lbs | OFFSET: -9
 MATTE BLACK: FRONT 14" x 7" 1522238-458 **\$279**⁹⁹
 REAR 14" x 8" 1522239-458 **\$279**⁹⁹

E 4204 
 FRONT WEIGHT: 13 lbs | LOAD RATING: 900 lbs | OFFSET: +4
 REAR WEIGHT: 14 lbs | LOAD RATING: 1,300 lbs | OFFSET: -9
 ACCENT: FRONT 14" x 7" 1522546-266 **\$189**⁹⁹
 REAR 14" x 8" 1522547-266 **\$189**⁹⁹
 MATTE BLACK: FRONT 14" x 7" 1522546-458 **\$169**⁹⁹
 REAR 14" x 8" 1522547-458 **\$169**⁹⁹

F 4205 
 FRONT WEIGHT: 10.5 lbs | LOAD RATING: 900 lbs | OFFSET: +4
 REAR WEIGHT: 12.5 lbs | LOAD RATING: 1,300 lbs | OFFSET: -9
 MATTE BLACK: FRONT 14" x 7" 1521507-521 **\$149**⁹⁹
 REAR 14" x 8" 1521508-521 **\$169**⁹⁹
 LUSTER: FRONT 14" x 7" 1521507-410 **\$189**⁹⁹
 REAR 14" x 8" 1521508-410 **\$199**⁹⁹

G 4301 BEADLOCK 
 FRONT/REAR WEIGHT: 16 lbs | LOAD RATING: 1,600 lbs | OFFSET: +38
 ACCENT: FRONT/REAR 14" x 7" 1523284 **\$269**⁹⁹
 MATTE BLACK: FRONT/REAR 14" x 7" 1523283 **\$259**⁹⁹

H HD DUAL BEADLOCK 
 FRONT/REAR WEIGHT: 40 lbs | LOAD RATING: 1,600 lbs | OFFSET: +38
 MATTE BLACK: FRONT/REAR 14" x 7" 1524022-458 **\$359**⁹⁹

BEADLOCK REQUIRED

BEADLOCK INCLUDED

INNER & OUTER BEADLOCK INCLUDED

BEADLOCK REQUIRED

BEADLOCK INCLUDED



BEADLOCK INCLUDED

BEADLOCK REQUIRED

BEADLOCK INCLUDED

BEADLOCK INCLUDED

BEADLOCK RINGS

14" FORGED BEADLOCK RINGS	PART #	MSRP
 Machined Fits 4203 Beadlock & HD Dual Beadlock	1522244-266	\$114 ⁹⁹
 Matte Black - Replacement Fits 5301 Beadlock & HD Dual Beadlock	1523146-458	\$74 ⁹⁹
15" FORGED BEADLOCK RINGS	PART #	MSRP
 Matte Black - Replacement Fits 5203 Beadlock	1523147-458	\$79 ⁹⁹

KNOW YOUR WHEELS

STEP 1: SELECT YOUR SERIES
4 = 40-SERIES 5 = 50-SERIES

STEP 2: CHOOSE YOUR LOAD RATING
1 = <800 LBS 2 = 801 - 1,300 LBS 3 = 1,301 - 1,600+ LBS

STEP 3: PICK YOUR STYLE
OFFSET / BEADLOCK / COLOR

**INCREASE OFFSET FROM STOCK = NARROWER STANCE
 DECREASE OFFSET FROM STOCK = WIDER STANCE**



	TRAIL	MUD	UTILITY	ROCK
40-SERIES	DUAL-THREAT 29" 3,000 Miles 4,828 km	MUD XC 27" 3,000 Miles 4,828 km	MUD XC 29" 3,000 Miles 4,828 km	HARVESTER 27" 5,000 Miles 8,047 km
	HARVESTER 28" 5,000 Miles 8,047 km	CRAWLER XR 28" 3,000 Miles 4,828 km	CRAWLER XG 30" 3,000 Miles 4,828 km	
4201 Accent	2883146 \$1,859 ⁹⁹	2884272 \$1,739 ⁹⁹	2884265 \$1,849 ⁹⁹	2882388 \$1,739 ⁹⁹
4201 Matte Black	2883147 \$1,739 ⁹⁹	2884273 \$1,612 ⁴⁹	2884266 \$1,715 ⁹⁹	2882389 \$1,599 ⁹⁹
4202 Accent	2883148 \$1,859 ⁹⁹	2884267 \$1,739 ⁹⁹	2884260 \$1,849 ⁹⁹	2882393 \$1,739 ⁹⁹
4202 Matte Black	2883149 \$1,739 ⁹⁹	2884268 \$1,612 ⁴⁹	2884261 \$1,715 ⁹⁹	2882394 \$1,859 ⁹⁹
4203 BEADLOCK Matte Black BEADLOCKS SOLD SEPARATELY				2881386 \$1,999 ⁹⁹
4204 Accent	2883150 \$1,859 ⁹⁹	2884270 \$1,739 ⁹⁹	2884263 \$1,799 ⁹⁹	2882395 \$1,739 ⁹⁹
4204 Matte Black	2883151 \$1,739 ⁹⁹	2884271 \$1,612 ⁴⁹	2884264 \$1,679 ⁹⁹	2882396 \$1,599 ⁹⁹
4205 Luster				2881371 \$1,739 ⁹⁹
4205 Matte Black	2883152 \$1,739 ⁹⁹	2884269 \$1,599 ⁹⁹	2884262 \$1,679 ⁹⁹	2882397 \$1,599 ⁹⁹
4301 BEADLOCK Accent BEADLOCKS PRE-MOUNTED	2883219 \$2,269 ⁹⁹			2883222 \$1,859 ⁹⁹
4301 BEADLOCK Matte Black BEADLOCKS PRE-MOUNTED	2883218 \$2,139 ⁹⁹			2881372 \$1,599 ⁹⁹
				2881563 \$1,859 ⁹⁹
				2881371 \$1,739 ⁹⁹
				2881564 \$1,999 ⁹⁹
				2881372 \$1,599 ⁹⁹
				2881563 \$1,859 ⁹⁹
				2883213 \$2,139 ⁹⁹
				2883211 \$2,399 ⁹⁹
				2883212 \$1,999 ⁹⁹
				2883210 \$2,269 ⁹⁹



	TRAIL	UTILITY	ROCK
50-SERIES	ATTACK 2.0 28" 3,000 Miles 4,828 km	ATTACK 2.0 30" 3,000 Miles 4,828 km	CRAWLER AT 30" 3,000 Miles 4,828 km
	HARVESTER 30" 5,000 Miles 8,047 km	CRAWLER XG 28" 3,000 Miles 4,828 km	CRAWLER XG 30" 3,000 Miles 4,828 km
5201 Accent	2883160 \$1,799 ⁹⁹	2883169 \$1,999 ⁹⁹	2889510 \$1,799 ⁹⁹
5201 Matte Black	2883159 \$1,669 ⁹⁹	2883168 \$1,859 ⁹⁹	2889511 \$1,679 ⁹⁹
5202 Accent	2883158 \$1,799 ⁹⁹	2883167 \$1,999 ⁹⁹	2889512 \$1,799 ⁹⁹
5202 Matte Black	2883157 \$1,669 ⁹⁹	2883166 \$1,859 ⁹⁹	2885046 \$1,679 ⁹⁹
5203 BEADLOCK Matte Black BEADLOCKS SOLD SEPARATELY	2883154 \$2,059 ⁹⁹	2883163 \$2,269 ⁹⁹	2889516 \$2,321 ⁹⁹
5301 BEADLOCK Accent BEADLOCKS PRE-MOUNTED	2883162 \$2,169 ⁹⁹	2883171 \$2,399 ⁹⁹	2889514 \$2,199 ⁹⁹
5301 BEADLOCK Matte Black BEADLOCKS PRE-MOUNTED	2883161 \$2,059 ⁹⁹	2883170 \$2,269 ⁹⁹	2889515 \$2,321 ⁹⁹
			2885047 \$2,321 ⁹⁹
			2883188 \$1,799 ⁹⁹
			2883187 \$1,669 ⁹⁹
			2883178 \$1,939 ⁹⁹
			2883186 \$1,799 ⁹⁹
			2883177 \$2,059 ⁹⁹
			2885046 \$1,679 ⁹⁹
			2883185 \$1,669 ⁹⁹
			2883176 \$1,939 ⁹⁹
			2883182 \$2,059 ⁹⁹
			2883173 \$2,329 ⁹⁹
			2883190 \$2,169 ⁹⁹
			2883181 \$2,469 ⁹⁹
			2885048 \$2,199 ⁹⁹
			2883189 \$2,059 ⁹⁹
			2883180 \$2,329 ⁹⁹

 COLBY SHORT ULTIMATE VALVE (2 PACK)
 » 2883292 • **\$34**⁹⁹

 COLBY VALVE SHORT ULTIMATE VALVE (2 PACK)
 » 2883293 • **\$34**⁹⁹

 COLBY COMBO VALVE KIT (16 PACK)
 • Includes eight ultimate valves and eight emergency valves
 » 2883294 • **\$599**⁹⁹

KNOW YOUR TERRAIN

- TRAIL**
 - Tread patterns optimized for extreme traction
 - Ideal for both hard pack and loose trail
- MUD**
 - Extra deep treads
 - Self-cleaning lugs
- UTILITY**
 - Triple-belted sidewalls to resist puncture
 - Purpose-built, long lasting tread patterns
- ROCK**
 - Flexible "grippy" tread
 - Aggressive side bite

WHEEL & TIRE SETS

REPLACEMENT CAPS

POLARIS		
LUSTER	ALL WHEELS EXCEPT 5203 BEADLOCK & 5204	1521509-410 \$15 ⁹⁹
MATTE BLACK		1521509-521 \$15 ⁹⁹
LUSTER	5203 BEADLOCK	1522243-410 \$30 ⁹⁹
MATTE BLACK		1522243-458 \$30 ⁹⁹
HD MATTE BLACK	ALL WHEELS	5457498-458 \$29 ⁹⁹

PRO ARMOR

LUSTER	ALL WHEELS EXCEPT 5203 BEADLOCK & 5204	5453209-410 \$15 ⁹⁹
MATTE BLACK		5453209-458 \$15 ⁹⁹
MATTE BLACK	5204	1523063-458 \$13 ⁹⁹
LUSTER	5203 BEADLOCK	1523015-410 \$15 ⁹⁹
MATTE BLACK		1523015-458 \$15 ⁹⁹

12mm x 1.5 SPLINED LUG NUTS

LUG NUTS REQUIRED	
16 SPLINED LUG NUTS WITH WRENCH ADAPTER	2879332 \$54 ⁹⁹
4 SPLINED LUG NUTS WITHOUT WRENCH	2879331 \$18 ⁹⁹
12mm x 1.5 SPLINED LUG WRENCH	2204966 \$12 ⁹⁹

2 WAYS TO PURCHASE

INDIVIDUAL WHEELS & TIRES
 - OR -
 COMPLETE SETS AS LISTED

VISIT Polaris.com/ProArmorGENERAL
 TO BUILD YOUR CUSTOM SET & VERIFY FITMENT
Exclusively at Polaris Authorized Dealers or Polaris.com/ProArmorGENERAL

WINCHES

TESTED **1,200+**
PULLS AT MAX LOAD

OPERATES FULLY
SUBMERGED

BUILT TO WITHSTAND
-20° F TEMPERATURES

MILITARY
TESTED & APPROVED



FEATURES & BENEFITS

PRO PRO HEAVY DUTY SERIES
BEST FOR PLOWING, HEAVY-DUTY OUTDOOR
CHORES & TRAIL RIDING

HD HEAVY DUTY SERIES
BEST FOR THE CASUAL
OFF-ROAD RIDER

ALL POLARIS
ENGINEERED
WINCHES COME WITH:



WARRANTY

- ✓ INTEGRATED WIRING, MOUNT, PREASSEMBLED
- ✓ HOOK WITH STRAP
- ✓ CUT STEEL GEARS & SEALED DRIVETRAIN
- ✓ SEALED PERMANENT MAGNET MOTOR



Retrieve cable 5x as fast as standard mode on other Polaris winches. Get back to riding or complete your task quicker.

1. Set winch dial to N (Neutral) to manually pull the rope out and secure the hook to your anchor point
2. Set winch dial to L (Low) for maximum pulling power while winching your load
3. Set winch dial to H (High) for retrieving the rope 5x faster with Rapid Rope Recovery



NOT AVAILABLE

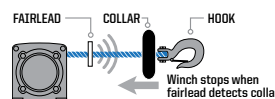

Auto Stop technology protects and extends the life of your winch by automatically stopping the winch at the end of pull to prevent over-spooling. While plowing, it prevents the plow frame from bending by stopping the winch once the plow has been lifted.



ADD AUTO STOP UPGRADE

2881288 • \$134⁹⁹
SYNTHETIC ROPE REQUIRED



With its lightweight, yet extremely strong, design and superior flexibility, this 50 ft long synthetic rope is easy to handle and can stand up to any tough job.



ADD SYNTHETIC ROPE

2879187 • \$179⁹⁹



This convenient remote operates your Polaris winch wirelessly from within 50 ft of the vehicle. Operate your winch safely outside your vehicle while on the job site or trails.



ADD WIRELESS REMOTE

2881287 • \$179⁹⁹



MODEL

4,500 LB.

4,500 LB.

POLARIS GENERAL XP 1000/4 '20-22
POLARIS GENERAL 1000/4 '19-22

2883861
\$1,139⁹⁹

TOP SELLER
2883860
\$809⁹⁹

PLOWS & TRACKS

PLOW SYSTEMS

(WINCH REQUIRED,
SOLD SEPARATELY)

Choose a Glacier Plow System, designed to help you get the most out of your GENERAL during snowy months. Select a system based on your plowing needs with premium add-ons including a hydraulic lift system or additional plow accessories.

NEW GLACIER PRO HD PLOW SYSTEM WITH HYDRAULICS

- System includes:
- Mount (2881763)
 - Frame (2880260)
 - 72" Steel Plow (2880270)
 - Hydraulic Angle (2885102)
 - Hydraulic Controller (2883391)
 - Plow Markers (2872726)
 - Plow Deflector (2858541)

» 3880014 • \$2,677⁹⁵
POLARIS GENERAL XP 1000/4 '20-22
POLARIS GENERAL 1000/4 '16-22

Requires lift method:
see winches below.

NEW GLACIER PRO HD PLOW SYSTEM

- System includes:
- Mount (2881763)
 - Frame (2880260)
 - 66" Poly Plow (2880269)

» 3880015 • \$1,586⁶⁶
POLARIS GENERAL XP 1000/4 '20-22
POLARIS GENERAL 1000/4 '16-22

Requires lift method:
see winches and hydraulic lift options below.

NEW GLACIER HD PLOW SYSTEM

- System includes:
- Mount (2883256)
 - Frame (2882927)
 - 72" Steel Plow (2889307)

» 3880016 • \$1,393¹⁶
POLARIS GENERAL XP 1000/4 '20-22
POLARIS GENERAL 1000/4 '16-22

Requires lift method:
see winches and hydraulic lift options below.

GLACIER PRO HD PLOW SYSTEM

» 72" or 66" Blades » Choice of poly or steel » Manual angle system standard



66" POLY BLADE
BEST FOR CORROSION RESISTANCE



72" STEEL BLADE
BEST FOR BIG JOBS YEAR AFTER YEAR

CREATE YOUR PLOW SYSTEM	STEP 1 SELECT A MOUNT	STEP 2 SELECT A FRAME	STEP 3 SELECT A LIFT METHOD	STEP 4 SELECT A BLADE	STEP 5 SELECT ACCESSORIES
MODELS	MOUNT	FRAME	WINCH	BLADES	ACCESSORIES
POLARIS GENERAL XP 1000/4 '20-22	2881763 \$439 ⁹⁹	TOP SELLER 2880260 \$609 ⁹⁹	Polaris PRO HD 4,500 lb. Winch 2883861 \$1,139 ⁹⁹ POLARIS GENERAL XP 1000/4 '20-22 POLARIS GENERAL 1000/4 '19-22	TOP SELLER 72" Steel 2880270 \$609 ⁹⁹ 66" Poly 2880269 \$539 ⁹⁹	72" Blade Snow Deflector 2858541 \$89 ⁹⁹ 72" HD Wear Bar 2879875 \$139 ⁹⁹ 72" Wear Bar 2204976 \$74 ⁹⁹ 66" Blade Snow Deflector 2879866 \$114 ⁹⁹ 66" HD Wear Bar 2879868 \$134 ⁹⁹ 66" Wear Bar 2879867 \$74 ⁹⁹ Plow Marker 2872726 \$43 ⁹⁹ 66" Blade Plow Shoe 2208864 \$34 ⁷⁹ Shear Pin 2205527 \$10 ⁹⁹ Replacement T Shear Pin 2204829 \$7 ⁹⁹ Extension for Tracks 2880267 \$339 ⁹⁹ Heavy Duty Deflector 2884160 \$194 ⁹⁹
POLARIS GENERAL 1000/4 '16-22			Hydraulic Plow Angle 2885102 \$649 ⁹⁹ POLARIS GENERAL 1000/4 '16-18 Hydraulic Plow Controller 2883391 \$259 ⁹⁹ POLARIS GENERAL XP 1000/4 '20-22 POLARIS GENERAL 1000/4 '16-22	TOP SELLER 66" Steel 2880268 \$469 ⁹⁹	

GLACIER HD PLOW SYSTEM

» 66" Blades » Choice of poly or steel » Manual angle system standard

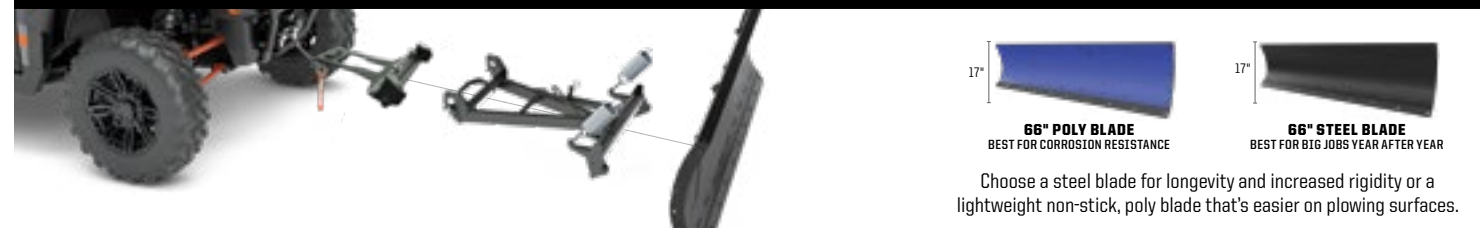

66" POLY BLADE
BEST FOR CORROSION RESISTANCE



66" STEEL BLADE
BEST FOR BIG JOBS YEAR AFTER YEAR

Choose a steel blade for longevity and increased rigidity or a lightweight non-stick, poly blade that's easier on plowing surfaces.

CREATE YOUR PLOW SYSTEM	STEP 1 SELECT A MOUNT	STEP 2 SELECT A FRAME	STEP 3 SELECT A LIFT METHOD	STEP 4 SELECT A BLADE	STEP 5 SELECT ACCESSORIES
MODELS	MOUNT	FRAME	WINCHES	BLADES	ACCESSORIES
POLARIS GENERAL XP 1000/4 '20-22	2883256 \$309 ⁹⁹	2889307 \$609 ⁹⁹	Polaris HD 4,500 lb. Winch 2883860 \$809 ⁹⁹ POLARIS GENERAL XP 1000/4 '20-22 POLARIS GENERAL 1000/4 '19-22	66" Poly 2880269 \$539 ⁹⁹ TOP SELLER 66" Steel 2880268 \$469 ⁹⁹	66" Blade Snow Deflector 2879866 \$114 ⁹⁹ 66" HD Wear Bar 2879868 \$134 ⁹⁹ 66" Wear Bar 2879867 \$74 ⁹⁹ Plow Marker 2872726 \$43 ⁹⁹ 66" Plow Shoe 2208864 \$34 ⁷⁹ Shear Pin 2205527 \$10 ⁹⁹ Replacement T Shear Pin 2204829 \$7 ⁹⁹



PROSPECTOR PRO® TRACK MOUNTS

• Install in place of tires and wheels. Tracks sold separately.

» 2880649 • \$649⁹⁹
POLARIS GENERAL 1000/4 '16-22

» 2885117 • \$649⁹⁹
POLARIS GENERAL XP 1000/4 '20-22

PROSPECTOR PRO® TRACK

» 2880758 • \$6,449⁹⁹

POLARIS GENERAL 1000/4 '16-22
POLARIS GENERAL XP 1000/4 '20-22
If using Glacier Pro Plow System, Track Plow Extension is required (2880267)

CHOOSE A PLOW SYSTEM

BUILD A PLOW SYSTEM

ACCESSORIES

WINDSHIELDS &
REAR PANELS

DOORS

ROOF &
PROTECTION

STORAGE CAB
COMFORT & HUNT

COOLERS

CONNECTED
TECHNOLOGY & AUDIO

LIGHTING

WHEELS & TIRES

WINCHES, PLOW
& TRACKS

FOR THE LIFE OF YOUR RIDE

PARTS THAT PUSH THE LIMITS WITHOUT SACRIFICING STRENGTH AND DURABILITY.
We build our products so anyone with the right tools can maintain their vehicle.

POLARIS
ENGINEERED PARTS & LUBRICANTS

PARTS & GARAGE

MAINTENANCE

OIL & LUBRICANTS

MAINTENANCE FLUIDS

BATTERIES & GARAGE ACCESSORIES

HO PARTS

SERVICE PARTS

TIRE SEALANT & TRAILERING

POLARIS POWER

HO PARTS

HO PARTS

MAINTENANCE TIP

BREAK-IN PERIOD

The break-in period for your new GENERAL is the first 25 hours of operation, or the time it takes to use the first two tanks of fuel. No single action on your part is as important as a proper break-in period. Careful treatment of a new engine will result in more efficient performance and longer life for the engine.

NOTICE: Excessive heat build-up during the first three hours of operation will damage close-fitted engine parts. Do not operate at full throttle or high speeds for extended periods during the first three hours of use.

SEE OUR LATEST MAINTENANCE TIPS AT GENERAL.POLARIS.COM/EN-CA/SELF-HELP

AIR FILTER

A clogged air filter can restrict air flow to the engine leading to reduced engine performance, engine life or catastrophic failure.

BRAKE PADS

Maintaining and/or replacing brakes are critical to the safety and functionality of a vehicle. Brake pads should be checked for wear and oil or grease (petroleum products) contamination and brake discs should be checked for cracks, excessive corrosion or warping.

HALF SHAFT

Check for tears and punctures in the boot, which can lead to CV joint wear that can contribute to axle failure.

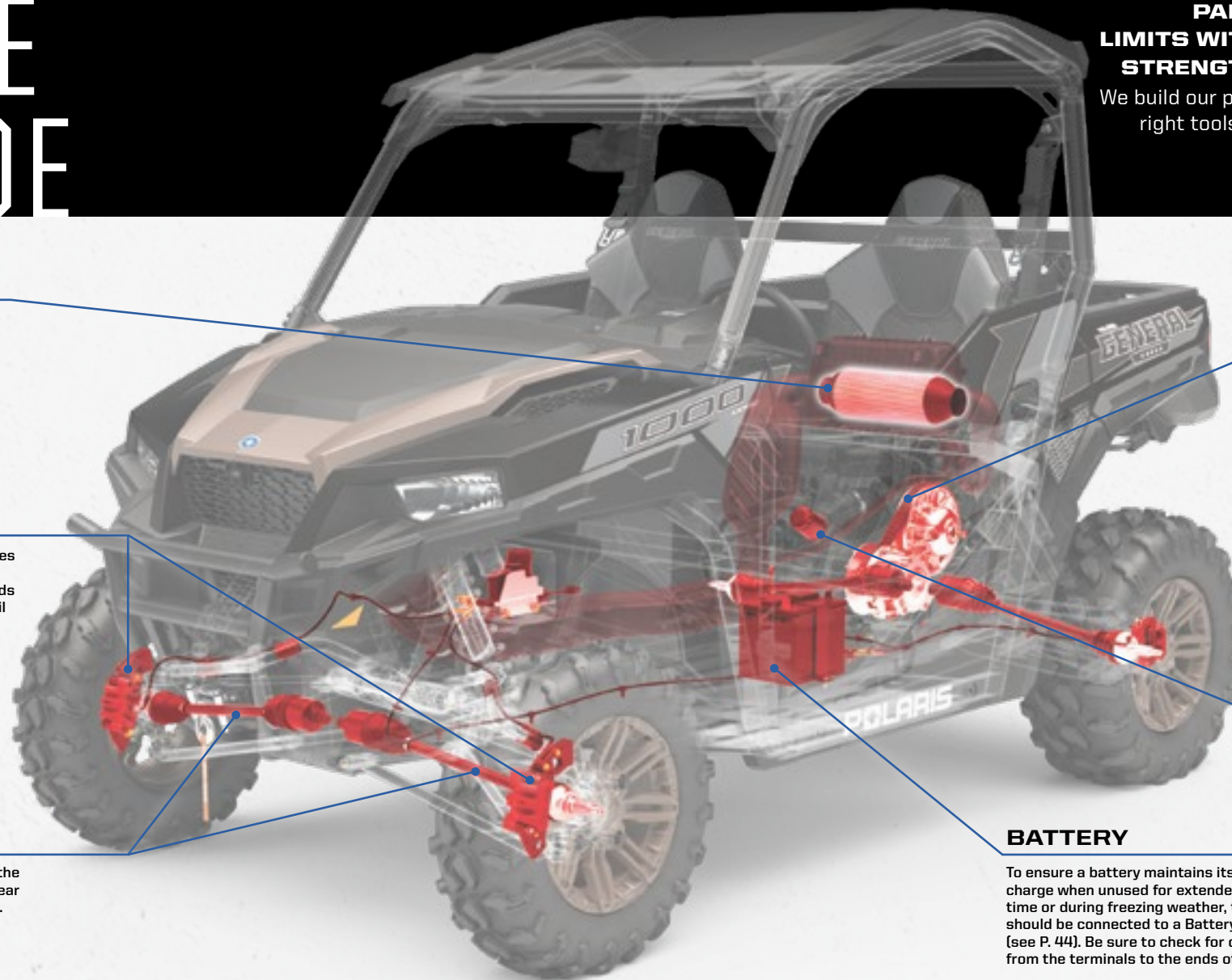

DRIVE BELT

Polaris Engineered belts deliver unmatched performance for your off-road vehicle. Developed and tested on all our engines for all environments and conditions. Check your belt for delamination, hour glassing and glazing.

BREAK-IN PERIOD

- Use lower gear (if available) while varying speeds and avoid wide open throttle for 5-10 miles / 8-16 km
- If no low gear is available, vary at moderate speeds while avoiding wide open throttle for 50 miles / 80 km

OUR INVESTMENT

- 40,000+ miles / 32,187 km of field testing
- Thousands of dyno hours
- 18+ months of development (13,000+ design hours) per belt
- 1,500+ vehicle validation hours
- Collaboration with powertrain and clutch engineers

YOUR ADVANTAGE

- No clutch recalibration
- Less wear and tear due to heat
- Ensure maximum vehicle performance
- More time riding, less time wrenching
- Produced in collaboration with powertrain and clutch engineers to ensure a perfect fit, maximum performance and ultimate durability

BATTERY

To ensure a battery maintains its level of charge when unused for extended periods of time or during freezing weather, the battery should be connected to a BatteryMINDER® (see P. 44). Be sure to check for corrosion from the terminals to the ends of the cables.

OIL FILTER

Change oil filters with every oil change to provide the best engine protection and keep the engine operating at peak performance.

FOLLOW RECOMMENDED SERVICE INTERVALS IN THE OWNER'S MANUAL

MAINTENANCE SCHEDULE

25 HRS / 250 Mi / 400 km

BREAK-IN MAINTENANCE

- ENGINE OIL & OIL FILTER:** CHANGE
- GENERAL LUBRICATION:** ALL FITTINGS, PIVOTS, CABLES, ETC.
- AIR FILTER:** INSPECT & REPLACE AS NEEDED
- EXHAUST SYSTEM:** INSPECT & CLEAN
INSPECT FOR LEAKAGE OR CARBON BUILD UP AT JOINTS
INSPECT & CLEAN SCREEN TYPE SPARK ARRESTOR

50 HRS / 500 Mi / 800 km

6 MONTHS

- EXHAUST SYSTEM:** INSPECT & CLEAN
INSPECT FOR LEAKAGE OR CARBON BUILD UP AT JOINTS
INSPECT & CLEAN SCREEN TYPE SPARK ARRESTOR
- GENERAL LUBRICATION:** ALL FITTINGS, PIVOTS, CABLES, ETC.
- DRIVE BELT:** INSPECT & ADJUST
REPLACE AS NEEDED

100 HRS / 1,000 Mi / 1,600 km

12 MONTHS

- ENGINE OIL & OIL FILTER:** CHANGE
- DRIVE BELT:** INSPECT & ADJUST
REPLACE AS NEEDED
- TRANSMISSION FLUID:** CHANGE
- AIR FILTER:** INSPECT & REPLACE AS NEEDED
- EXHAUST SYSTEM:** INSPECT & CLEAN
INSPECT FOR LEAKAGE OR CARBON BUILD UP AT JOINTS
INSPECT & CLEAN SCREEN TYPE SPARK ARRESTOR

150 HRS / 1,500 Mi / 2,400 km

18 MONTHS

- ENGINE OIL & OIL FILTER:** CHANGE
- BATTERY:** TEST, CLEAN & CHECK FLUID LEVEL
REPLACE AS NEEDED
- DRIVE BELT:** INSPECT & ADJUST
REPLACE AS NEEDED
- TIRES:** INSPECT CONDITION & PRESSURE
- EXHAUST SYSTEM:** INSPECT & CLEAN
INSPECT FOR LEAKAGE OR CARBON BUILD UP AT JOINTS
INSPECT & CLEAN SCREEN TYPE SPARK ARRESTOR

200 HRS / 2,000 Mi / 3,200 km

24 MONTHS

- ENGINE OIL & OIL FILTER:** CHANGE
- BRAKE PADS & FLUID:** INSPECT & CLEAN
REPLACE BRAKE FLUID
REPLACE AS NEEDED
- SPARK PLUGS:** INSPECT
REPLACE AS NEEDED
- AIR FILTER:** INSPECT & REPLACE AS NEEDED
- EXHAUST SYSTEM:** INSPECT & CLEAN
INSPECT FOR LEAKAGE OR CARBON BUILD UP AT JOINTS
INSPECT & CLEAN SCREEN TYPE SPARK ARRESTOR

250 HRS / 2,500 Mi / 4,023 km

30 MONTHS

- ENGINE OIL & OIL FILTER:** CHANGE
- BATTERY:** TEST, CLEAN & CHECK FLUID LEVEL
REPLACE AS NEEDED
- DRIVE BELT:** INSPECT & ADJUST
REPLACE AS NEEDED
- GENERAL LUBRICATION:** ALL FITTINGS, PIVOTS, CABLES, ETC.
- EXHAUST SYSTEM:** INSPECT & CLEAN
INSPECT FOR LEAKAGE OR CARBON BUILD UP AT JOINTS
INSPECT & CLEAN SCREEN TYPE SPARK ARRESTOR

300 HRS / 3,000 Mi / 4,828 km

36 MONTHS

- ENGINE OIL & OIL FILTER:** CHANGE
- AIR FILTER:** INSPECT & REPLACE AS NEEDED
- GEARCASE & TRANSMISSION:** REPLACE FLUIDS
- EXHAUST SYSTEM:** INSPECT & CLEAN
INSPECT FOR LEAKAGE OR CARBON BUILD UP AT JOINTS
INSPECT & CLEAN SCREEN TYPE SPARK ARRESTOR

CHECK YOUR OWNER'S MANUAL FOR ADDITIONAL RECOMMENDED SERVICE ITEMS AND VEHICLE-SPECIFIC TIMING

OIL



NEW PS-4 FORMULATIONS BEST PROTECTION, BEST PERFORMANCE

Our new PS-4 5W-50 formulation and PS-4 Extreme Synthetic 0W-50 have been designed to provide the best fluid technologies for long lasting wear protection. These formulations include a new Polaris exclusive additive system to keep the engine cleaner from deposit build-up to maximize power and powersports-grade synthetic base stocks that provide the ultimate in engine protection.

PS-4 5W-50 FULL-SYNTHETIC OIL

Optimal for ambient operating temperatures of -40° F to 100° F

- » 1 Quart 2876244
- » 1 Gallon 2876245
- » 16 Gallons 2876247
- » 55 Gallon Drum 2876246
- » 330 Gallon Tote 2878814

PS-4 0W-50 EXTREME FULL-SYNTHETIC OIL

Optimal for ambient operating temperatures of 0° F to 130° F

- » 1 Quart 2889395
- » 1 Gallon 2889396
- » 16 Gallons 2889397
- » 55 Gallon Drum 2889398
- » 330 Gallon Tote 2889399

OIL CHANGE KITS

PS-4		These convenient kits include everything needed including filter and oil volume per vehicle	PS-4 EXTREME
PART NUMBER	VEHICLE FITMENT		PART NUMBER
2202166	RANGER/RZR/SPORTSMAN 570, TWIN 600, TWIN 700, TWIN 800		2879004
2879323	RANGER, POLARIS GENERAL 900-1000, RZR 900-1000, RS1		2879324
2877473	RANGER/SPORTSMAN 300-500, SPORTSMAN/SCRAMBLER 500/850/1000		2878924
2881696	RZR TURBO		2881697

ENGINE WEAR TEST LOWER NUMBER = LESS WEAR OF CRITICAL ENGINE PARTS LESS WEAR MEANS LONGER ENGINE LIFE

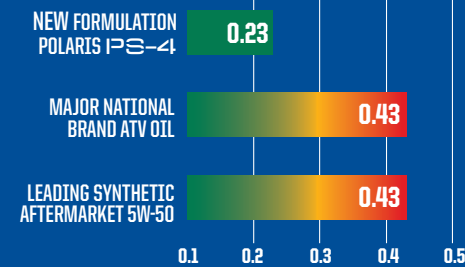

ASTM D4172. In 3rd party against 11 competitive products Polaris had 40% or better wear protection compared to all of the test products.

THE BEST PROTECTION

- At least 40% improved wear protection compared to previous Polaris PS-4 formulation and all aftermarket oils tested

Best engine protection against wear for the longest engine life.

DEPOSIT TEST LOWER DEPOSITS = MAXIMUM POWER

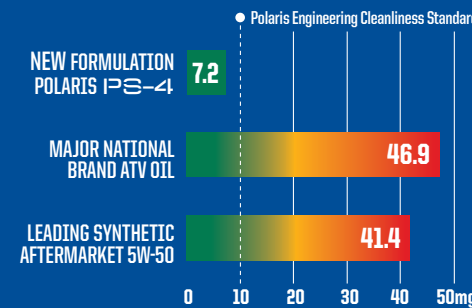

ASTM D6395. In 3rd party against 9 competitive products Polaris PS-4 had less than half the deposits compared to the next closest product. No other tested products met Polaris Engineering standards for deposit cleanliness.

MAXIMUM PERFORMANCE

- New improved PS-4 formulation provides 33% less deposits than previous PS-4 formula

- At least 50% less deposits than all aftermarket oils tested

The cleanest engine for maximum power and performance!

POLARIS EXTREME SYNTHETICS

Our new PS-4 Extreme Synthetic 0W-50 formulation applies only to the **absolute highest performance** products we sell, for ultimate protection and performance in the most extreme conditions.

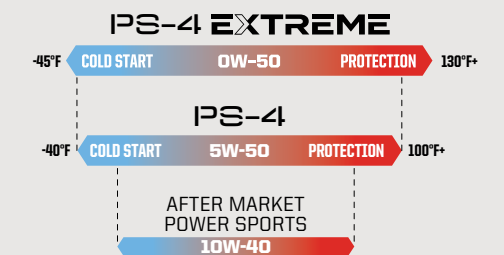

- Our best extreme high temp formulation, excellent for severe high temperatures and for racing, even at temps over 54°C.

- Provides easier starting and cold temperature protection, even to extreme cold temps of below -42°C.

- Latest in premium synthetic PAO and Ester base stocks along with careful balance of moly and ZDDP additives for ultimate long lasting wear protection.

- Polaris exclusive clean engine additive system reduces deposits and carbon build-up for peak performance and power.



POLARIS INVESTS IN EACH OIL AT AND ABOVE THESE LEVELS

12+ DEDICATED
TEAM MEMBERS

FOCUSED ON
POLARIS OIL

18+
MONTHS

DEVELOPMENT
& TESTING

76,000+
HOURS

DYNO
TESTING

1.9 MILLION
MILES (3,057,753 KM)

FIELD
TESTING

MAINTENANCE FLUIDS



ENGINE OIL

Maximum protection for your 4-cycle engine.

Change every 100 hours, 6 months or 500 miles / 800 km.



AGL

Protect gears, drive chain and bearings from scoring and wear.

Change every 100 hours, 12 months or 1,000 miles / 1,600 km.

- » 1 QT • 2878068
- » 1 GALLON • 2878069
- » 2.5 GALLONS • 2878070
- » 55 GALLONS • 2879594

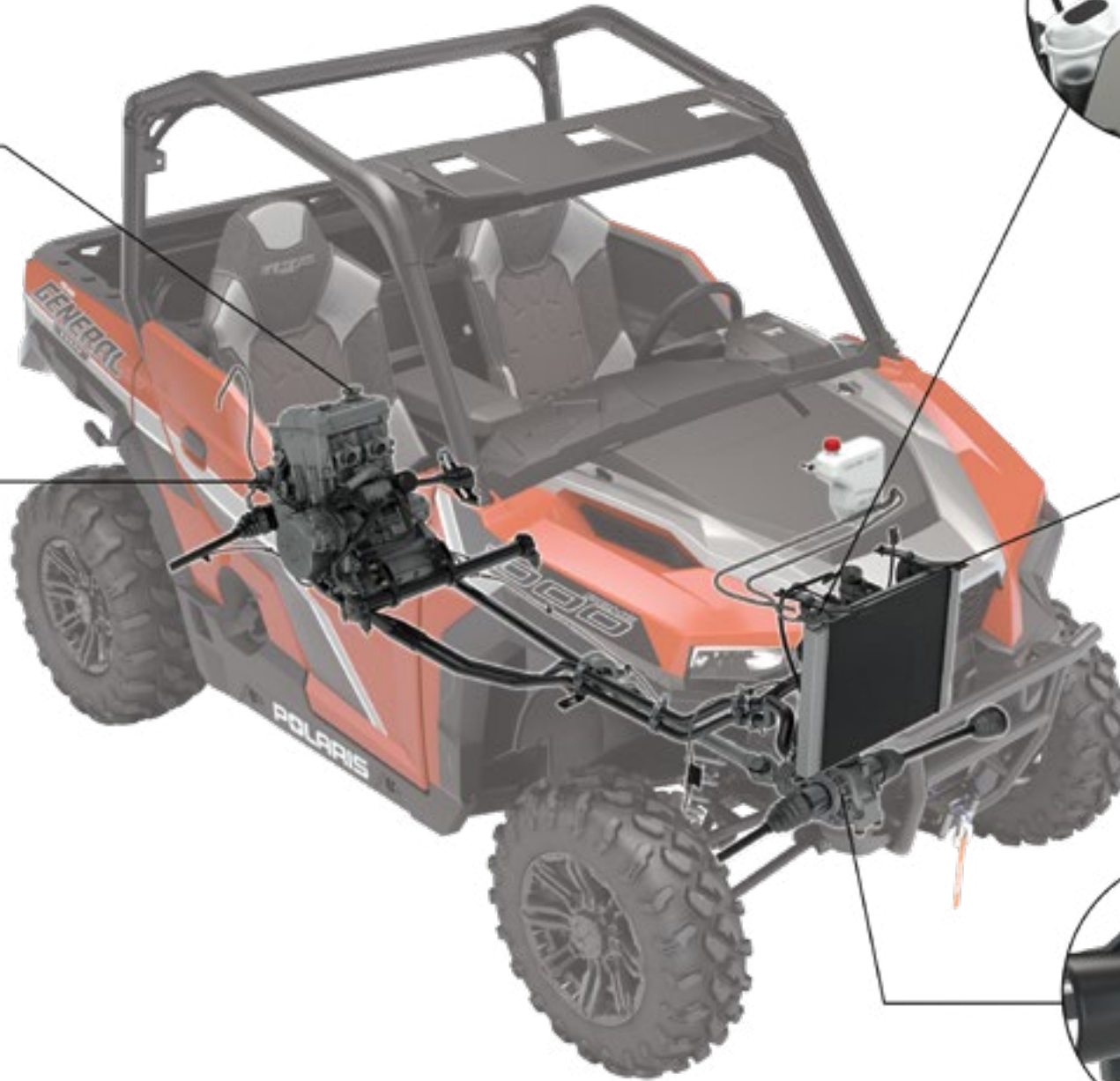

DOT 4 BRAKE FLUID

A high-quality brake fluid designed for use in Polaris hydraulic brakes.

Change every 200 hours, 2 years or 2,000 miles / 3,200 km.

- » 12 OZ • 2872189



ANTI-FREEZE

Prevent corrosion on metal components, eliminate scaling and maximize cooling system performance.

Change every 60 months.

- » 1 QT • 2880514
- » 1 GALLON • 2880513
- » 55 GALLONS • 2880512



DEMAND DRIVE FLUID

Provide positive 4WD engagement in extreme cold or high heat conditions and protect internal components under heavy loads.

Change every 100 hours or yearly.

- » 1 QT • 2877922
- » 2.5 GALLONS • 2877923



ORV MAINTENANCE KITS

Everything you need, in the correct fluid volumes, to maintain your drive train and keep your vehicle in top operating condition

• Includes: 1.5 quarts AGL, 1 quart Angle Drive Fluid, 1 pint Demand Drive Fluid, 1-3 OZ tube of All-Season Grease

» 2880425

ALL MODELS

• Includes: 2 Spark Plugs, 1 Air Filter, 2 quarts PS-4, 1 Oil Filter, 2 pints Transmission Fluid, 1 quart AGL, 1 Crush Washer, 1 Paper Funnel

» 2830544

GENERAL 1000/4 '16-22



PREMIUM GAS SHOCK OIL

» 1 QT • 2874124

WALKER EVANS RACING® REBUILDABLE SHOCKS

» 1 QT PREMIUM • 2870995

» 2.5 GALLONS PREMIUM • 2872279

FOX® REBUILDABLE SHOCKS



SUSPENSION/ U-JOINT GREASE

» 3 OZ • 2871515

» 14 OZ • 2871551



CHAIN LUBRICANT

• Provides superior anti-wear and shock protection

» 16 OZ AEROSOL 2872348



ALL-SEASON GREASE TUBE

• Specialized water-resistant lubricant

» 3 OZ • 2871322

» 14 OZ • 2871423



ANGLE DRIVE FLUID

• Extreme pressure, anti-wear and high viscosity film lubrication for maximum protection

» 1 QT • 2876160

» 2.5 GALLONS • 2872276

SPORTSMAN, RANGER, RZR ANGLE DRIVE GEAR CASE SYSTEMS



GENERATOR OIL

• 4-cycle engine oil

» 1 QT • 2879383



CARBON CLEAN

• Ultimate fuel and injection system cleaner

» 12 OZ • 2881413



ADVANCED FUEL TREATMENT

• Dual antioxidant formula protects jets and fuel system from gum and varnish

» 12 OZ • 2881416

» 2.5 GALLONS • 2881417

BatteryMINDER®

ENSURE YOUR RIDE IS READY WHEN YOU ARE.

GARAGE ACCESSORIES



NEW
PREMIUM MAINTENANCE TOOL KIT

- Includes everything you need to work on and repair Polaris vehicles
- Lifetime warranty on select tools

» 2830565 • **\$659⁹⁹**

- Add years of capacity, power and range to new and older batteries, regardless of type or brand
- Never over- or under-charged in any temperature
- Leave your vehicle connected for months and return to fully charged and conditioned batteries
- Recover older or weak batteries that would normally need to be replaced

- Charge and maintain extra backup batteries, as well as those in your vehicle
- Automatic turn-on, sleeps while keeping your batteries at full charge
- Easy push-button selector to change battery type or time



NEW
1,000 AMP ULTRASAFE LITHIUM JUMP PACK

- Delivers 1,000 amps for jump starting a dead battery in seconds

» 2830547 • **\$169⁹⁹**



NEW
JUMP PACK PROTECTION CASE

- Lightweight, durable and rugged custom exterior

» 2830548 • **\$26⁹⁹**



FLEX SPOUT

- Fits all Polaris quart, gallon and 2.5 gallon bottles

» 2871285 • **\$3⁹⁹**



FLUID FUNNEL

- Easily add oil with high accuracy

» 2830552 • **\$17⁹⁹**



GREASE GUN

- Enables easy application of grease

» 2871312 • **\$44⁹⁹**

FITS 2871322 ALL-SEASON AND 2871515 U-JOINT 3 OZ



PUMP

- Fits 1 and 2.5 gallon bottles

» 2870465 • **\$9⁹⁹**



FLUID TRAY

- Holds up to 8 quarts of fluid

» 2830551 • **\$26⁹⁹**



2D BATTERY-OPERATED SIPHON PUMP

- Liquid transfer pumps 5-6 quarts/min suctioning power

» 2830513 • **\$20⁹⁹**



POLARIS SHOP TOWELS

- » 200 CT WITH DISPENSER (SHOWN) 2830402 • **\$28⁹⁹**
- » 200 CT REFILL • 2830403 • **\$19⁹⁹**
- » 64 CT REFILL • 2830440 • **\$6⁹⁹**



OIL FILTER WRENCH

- Remove Polaris ORV oil filters with ease

» 2830550 • **\$10⁹⁹**



FLUID SYRINGE

- Easily add and remove fluid from your vehicle

» 2830553 • **\$39⁹⁹**



POLARIS HEAVY-DUTY SCRUBBER WIPES

- » 90 CT • 2830441 • **\$24⁹⁹**

	2012 AGM 2 AMP	2012 LEAD ACID 2 AMP	1510 1.5 AMP	1.5 AMP CONVERTIBLE
PART NUMBER • PRICE	2830438 • \$121⁹⁹	2830531 • \$109⁹⁹	2830404 • \$79⁹⁹	2830511 • \$91⁴⁹
VOLTAGE • WARRANTY	12 V • 5 Years	12 V • 5 Years	12 V • 10 Years	12 V • 5 Years
CHARGING CURRENT	2 amp	2 amp	1.5 amp	1.5 amp
OVERCHARGE PROTECTION	Yes			
BATTERIES MAINTAINED	6 at one time		4 at one time	
BATTERY COMPATIBILITY	12 V Sealed AGM Lead-Acid	12 V Flooded (filler cap) and Sealed Maintenance-Free Batteries		
COMES WITH	• Non-fused battery clip cord set with Quick Connector	• BC-2410: 2' non-fused battery clip cord set with Quick Connector • RTA-2415: 2' fused ring terminal cord set with Quick Connector • ATS-1: Ambient temperature sensor	• Ambient temperature sensor (installed) • 12' power cord • Battery clip cord set with Quick Connector	• Auto-temp compensation sensor (installed) • Optional permanent mounting brackets and screws • Battery clips (fully-insulated, aircraft grade, 15A replaceable fuse) • Ring terminal assembly with 15A replaceable fuse
KEY FEATURES	Designed for high-performance specialty AGM sealed batteries	Diagnoses battery condition - can predict failing batteries	Easy to use, economical	Convertible on-vehicle or bench top use

BATTERY MAINTENANCE TIPS

Extend your battery life with a BatteryMINDER® and these tips:

1. Store batteries in a cool, dry location.
2. Check that the battery connections are tight. Cables should not be able to be rotated or shifted by hand.
3. If your battery has a drain tube, make sure it is free of clogs.
4. Clean your battery - use a soft brush to scrub the top of the battery. Use baking soda to remove grease.
5. Connect a BatteryMINDER® after using your vehicle even if the vehicle is in regular use.

BatteryMINDER® ACCESSORIES



BatteryMINDER® 12' CABLE

- Made with heavy-duty, 16-gauge black zip cord featuring automotive SAE bullet connectors

» 2830410 • **\$15⁹⁹**



BatteryMINDER® VPP-12:12/24 VOLT VEHICLE POWER PLUG

- Allows easy connection to vehicle battery through lighter or 12/24 V power port with replaceable 15 amp fuse

» 2830518 • **\$16⁹⁹**



BatteryMINDER® SPLITTER

- Connect two batteries simultaneously for easy battery maintenance
- Cap includes a set of ring terminals

» 2830409 • **\$45⁹⁹**



BatteryMINDER® RING TERMINAL

- Features 24" long 18-gauge wire
- Plug has standard 5/16" negative and 3/8" positive terminals
- Replaceable 15 amp in-line fuse for circuit protection

» 2830437 • **\$12⁹⁹**



BatteryMINDER® EZ CONNECT

- Allows for quick, easy connecting and disconnecting of your BatteryMINDER®
- Includes a set of ring terminals

» 2830411 • **\$32⁹⁹**



POLARIS X3 CREEPER

- Three positions: Flat, 45-degree angle or seated work stool
- Helps you perform any repair with ease
- Stay dry and warm away from cold, wet cement floors
- Easily stores away when not in use

» BLACK • 2830429 • **\$179⁹⁹**



POLARIS MAGNETIC PARTS TRAY

- » SILVER • 2830432 • **\$15⁹⁹**



POLARIS 33" TELESCOPIC MAGNET

- » BLACK • 2830435 • **\$6⁹⁹**



POLARIS 12" HI-TORQUE RATCHETING DRIVER

- » BLACK / BLUE • 2830434 • **\$24⁹⁹**



POLARIS LED POCKET FLASHLIGHT

- » BLACK • 2830436 • **\$30⁹⁹**

HD HEAVY DUTY PARTS

All Polaris parts are developed and tested to help you get the most out of your ride. We're taking the passion of our riders, workers and outdoor enthusiasts to the next level with HD Parts.

Engineered and designed for:

- Greater durability
- Enhanced performance
- Greater wear and tear capabilities
- All weather conditions

NEW DRIVE BELTS

The enhanced rubber material compound in these belts keep them cool in extreme heat, while our patented cord treatment process maximizes the transfer of horsepower to the ground for those customers hauling heavy loads.

OE	HD HEAVY DUTY PARTS
3211149	
3211169	3212326
3211196	
3211113	3212328

NEW OIL FILTERS

The advanced synthetic material built into these filters offers the highest debris holding capacity, maintains oil flow and maximizes performance.

OE	HD HEAVY DUTY PARTS
2540086	2522498

WHEELS & TIRES

Class leading durability for off-road performance and traction for confident driving in extreme conditions.

- » 1524022-458 • HD WHEEL - 14x7*
- » 5417507 • PRO ARMOR HD-K - 29x10R14*
- » 5457498-458 • HD WHEEL CENTER CAP*
- » 5415756 • PRO ARMOR XD-K FRONT
- » 5415757 • PRO ARMOR XD-K REAR

* SHOWN

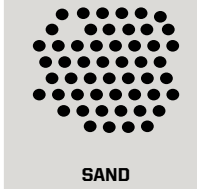

SAND



MUD



WATER



EXTREME COLD



EXTREME HEAT UP TO 130° F

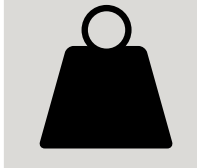

HEAVY PAYLOADS

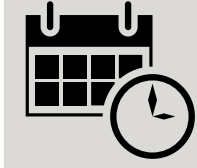

EXTENDED LIFE

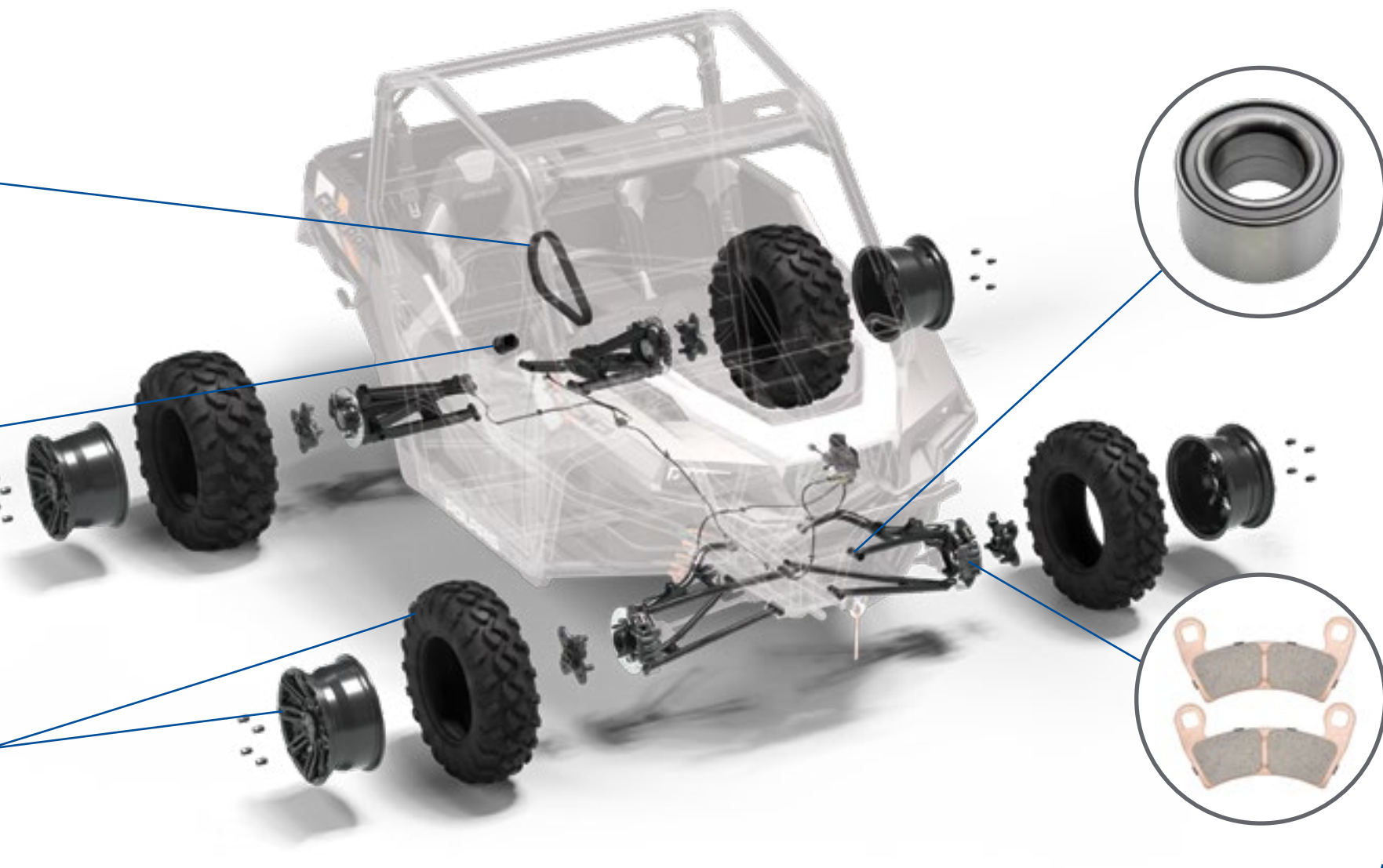

WHEEL BEARINGS

Fully sealed for added protection against intrusions. Made of a higher grade steel for extended life in extreme conditions.

LOCATION	OE	HD HEAVY DUTY PARTS
FRONT		
REAR	3514924	3515090



BRAKES

Engineered to provide longer life and better stopping power while riding in extreme conditions.

OE	HD HEAVY DUTY PARTS
2205949	2208933
2202413	2208934
2203318	2208936



Claims made based off testing and performance of Polaris HD Parts against standard OEM parts made by Polaris and competitor brands under normal use.

For more information regarding Polaris HD parts including vehicle compatibility, installation and maintenance, please contact your authorized Polaris ORV dealer.

VISIT POLARIS.COM/SHOPGENERAL TO LEARN MORE

SERVICE PARTS

Polaris Engineered service parts deliver unmatched performance and fit for your off-road vehicle.

All service parts are engineered specifically for your machine. Which means everything is designed, tested and perfected to maximize the life of your ride. Getting Polaris Engineered parts is a decision that pays off in the long run, because it ensures there is a long run.



SHOP FOR SERVICE PARTS ONLINE OR VISIT YOUR POLARIS DEALER.

OVER
100,000
PARTS
AVAILABLE!



CHECK OUT OUR PARTS FINDER ON POLARIS.COM

FOR EASY PARTS LOOK-UP, PARTS IDENTIFICATION, VIEWS OF ASSEMBLIES & MORE!

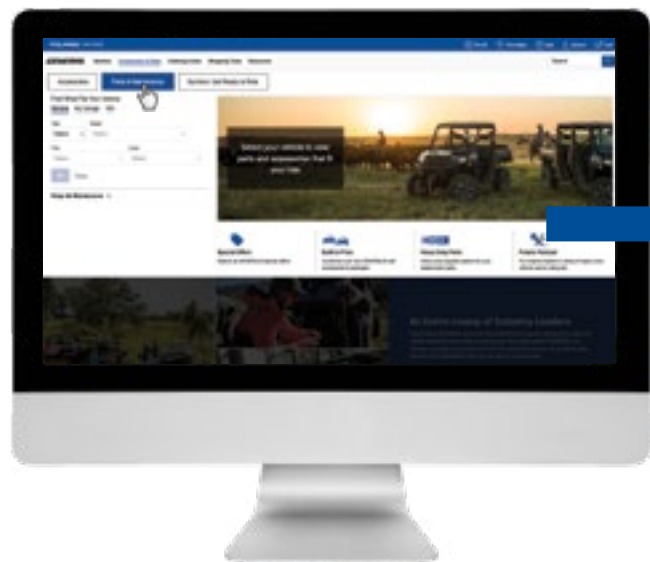

STEP 1

Visit **Polaris.com/GENERAL**
Click the **"Accessories & Parts"** tab
Click **"Parts & Maintenance"**



STEP 2

Enter **vehicle year/model** or
shop by **part number**



STEP 3

Clearly see what parts are
required and **order**

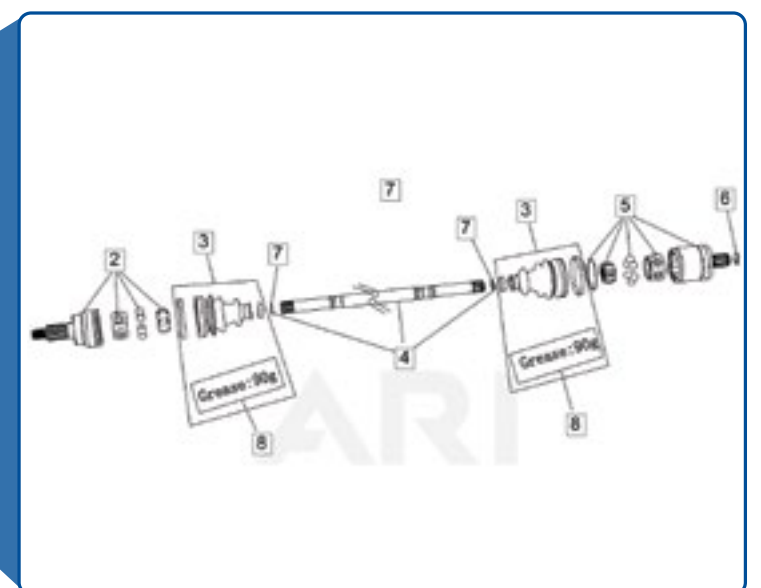

CV BOOT REPAIR KIT*

- A quick trail-side fix to increase trail time
- The flexible and durable boot material expands "over a cone tool for CV boot repairs, without disassembling CV axles
- Universal fit - works as a temporary fix for most powersports axles
- All components fit inside the cone, and a cover is provided for compact durable storage
- Easily fits in a cargo box, attached to the roll cage, in the glovebox or many other storage locations



Items shown are contained inside cone

FIX ON THE GO | TEMPORARY COVERAGE

UTV CV BOOT REPAIR KIT

- Kit includes the following items:
- (1) Expandable XL CV Boot
 - (1) Reusable Cone Tool
 - (2) CV Boot Clamps
 - (1) Tube of Silicone Lube
 - (1) Grease Packet
 - (1) Cone Cover
- » 2830526 • \$36⁹⁹

UTV TRAIL BOOT ONLY

- » 2830527 • \$18⁹⁹
- ### ATV
- CV REPAIR KIT 2830528 • \$31⁹⁹
 - TRAIL BOOT ONLY 2830529 • \$18⁹⁹

SEE HOW THE CV BOOT REPAIR KIT WORKS AT POLARIS.COM/MAINTENANCE-VIDEOS

HOW TO INSTALL

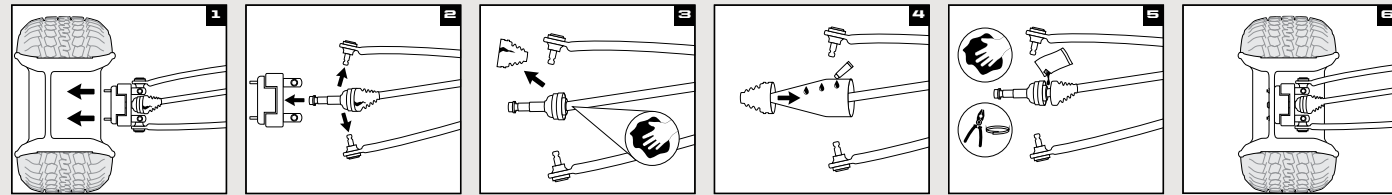

- Remove wheel and axle nut.
- Remove brake caliper, hub, tie rod and upper and lower ball joints.
- Remove old boot and clean joint.
- Spread silicone lube on entire cone tool. Slide boot over cone tool, large end first. See package for outer boot instructions.
- Empty the bag of grease into the CV joint/boot, clean sealing points and install clamps.
- Reassemble tie rod, ball joints, brake caliper, axle nut, tire and wheel.

Refer to your service manual for further instructions and torque specifications.
*Designed for temporary CV boot repair. Purchase the OEM CV Boot for a permanent repair.

TIRE SEALANT

HOW IT WORKS

Tire sealant remains liquefied inside the tire until a leak develops in the tire or wheel.



Once a leak occurs, the tire sealant rushes out of the tire and quickly creates a permanent solid plug.

The plug maintains the pressure of the tire so you can continue your ride.



HOW MUCH TIRE SEALANT DO YOU NEED?

$$\frac{\text{TIRE HEIGHT (IN.)} \times \text{TIRE WIDTH (IN.)}}{5} = \text{OUNCES REQUIRED PER TIRE}$$

$$\frac{27" \times 10"}{5} = 54 \text{ oz}$$

FOR A FULL APPLICATION CHART, VISIT POLARIS.COM/TIRESEALANTCHART

PREMIUM TIRE SEALANT

- Instantly seals and repairs rim, bead leaks and punctures up to .25" on standard tires and .75" on heavy ply tires
- Helps maintain air pressure for the life of the tire
- Helps seal the tire bead against the wheel
- 100% water soluble for easy cleanup
- Will not rust, corrode or pit wheels
- Creates permanent repair
- Remains fluid and effective in temperatures down to -45° F
- Easily installed through existing tire valve stem with valve core removed

- » 32 OZ • 2830484 • \$25⁹⁹
- » 1 GALLON • 2830485 • \$89⁹⁹
- » 5 GALLONS • 2830486 • \$364⁹⁹
- » 5 GALLONS, PUMP • 2830487 • \$163⁹⁹
- » 55 GALLONS • 2830489
- » 275 GALLONS • 2830488

BRING IT EVERYWHERE

TRAILERING



CALIBER® RAMP PRO

- Designed for ATVs and UTVs up to 50" wide
 - Integrated grip glides for ultimate traction
 - Folding sides for easy transportation and storing
- » 52" x 90" • 2884576 • \$519⁹⁹



ALUMINUM ARCHED LOADING RAMPS

- Capacity for up to 3,000 lbs, 1,500 lbs per ramp
- » 76" x 12" • 2,000 lb • 2875384 • \$279⁹⁹
- » 88" x 12" • 3,000 lb • 2875386 • \$459⁹⁹



LIGHTWEIGHT TRI-FOLD RAMPS

- Ramp folds up for transport
- Capacity for up to 1,500 lbs
- Safety straps included
- » 72" x 51" • 2875385 • \$309⁹⁹
- » 82" x 51" • 2875860 • \$369⁹⁹



FOLDING ALUMINUM ARCHED RAMPS

- Ramp folds up for transport
- Up to 1,500 lb total capacity, per individual ramp
- Safety straps included
- » 88" x 12" • 2875387 • \$379⁹⁹

HITCHES

3:1 HITCHES VERSATILE 3 IN 1 FUNCTIONALITY

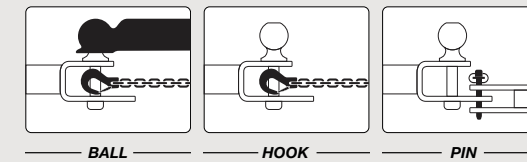

- Ball, hook and pin design
- Durable, rust resistant steel with black powdercoated finish
- Removable ball
- HD 5/8" pin and clip



HITCH WITH 2" BALL

- » 2" x 2" RECEIVER 2830522 • \$48⁹⁹
- » 1 1/4" x 1 1/4" RECEIVER 2830523 • \$48⁹⁹



1 7/8" BALL

- 1 3/8" replacement ball for hitch
- Designed to work with 3:1 Hitch
- » 2830524 • \$12⁹⁹



RECEIVER HITCH

- » 2" RECEIVER TONGUE 2875320 • \$59⁹⁹



TRAILER BALL 3/4" SHANK

- » 1 7/8" BALL • 2877602 • \$18⁹⁹
- » 2" BALL • 2877603 • \$18⁹⁹

STRAPS & ROPES



RECOVERY STRAP

- 2" x 30'
- 18,000 lb maximum load / 9,000 lb maximum vehicle weight
- Comes with carry bag
- » 2884033 • \$74⁹⁹



RATCHET STRAP

- 1.5" x 15' straps, 2 Pack
- Heavy duty webbing
- 5,500 lb maximum load, 1,833 lb working load
- » 2884031 • \$59⁹⁹



RATCHET STRAP

- 2" x 20' Ratchet Straps
- Heavy duty webbing, floating D-rings, double J-hooks
- 10,000 lb maximum load, 3,300 lb working load
- » 2884032 • \$43⁹⁹



SHOCK STRAPS

- 1.5" 3,000 lb breaking strength
- Keeps tension on tie-down straps to secure load, 2 Pack
- » 1.5" x 15' • 2883296 • \$109⁹⁹
- » 1.5" x 7' • 2883295 • \$94⁹⁹

COVERS



TRAILERABLE COVER BY POLARIS

- » 2-SEAT • 2881841 • \$469⁹⁹
- POLARIS GENERAL XP 1000 '20-'22
- POLARIS GENERAL 1000 '16-'22
- » 4-SEAT • 2881787 • \$564⁹⁹
- POLARIS GENERAL XP 4 1000 '20-'22
- POLARIS GENERAL 4 1000 '17-'22



POLARIS SxS CAMO FIELD COVER

- » 2882160 • \$169⁹⁹
- POLARIS GENERAL XP 1000/4 '20-'22
- POLARIS GENERAL 1000/4 '16-'21

PARTS & GARAGE

MAINTENANCE

OIL & LUBRICANTS

MAINTENANCE FLUIDS

BATTERIES & GARAGE ACCESSORIES

HO PARTS

SERVICE PARTS

TIRE SEALANT & TRAILERING

POLARIS POWER

POLARIS POWER

FOR THE WORKERS, PLAYERS
AND SAVE-THE-DAYERS.



THE POWER TO EMPOWER

At Polaris Power, we are committed to powering more. We proudly donate 3% of our profits by providing portable power to areas affected by natural disasters and the organizations providing relief in North America.

PARTS & GARAGE

MAINTENANCE

OIL & LUBRICANTS

MAINTENANCE
FLUIDS

BATTERIES & GARAGE
ACCESSORIES

HD PARTS

SERVICE PARTS

TIRE SEALANT
& TRAILERING

POLARIS POWER



P2000i

Inverter Generator

2830532

\$899 99

1600 Running Watts	2000 Starting Watts	16.7 Max Amps at 120V	7.6 Run Time at 25% Load w/ Smart Throttle (hrs)	62 Noise Level at 25% Load (dBA)
------------------------------	-------------------------------	---------------------------------	--	--

FEATURES



Extension Cord Management



Multi Functional Digital Display



Illuminated Control Panel



Multi Handle Design



Parallel Capable

BEST USED FOR



Tailgating



Off-Grid



Camping



ACCESSORIES 2830536 INVERTER PARALLEL KIT
2830540 ALL WEATHER COVER

2884865 HIGH ALTITUDE MODIFICATION KIT
2879383 GENERATOR OIL

P3200iE

Inverter Generator

2830533

\$1,899 99

2800 Running Watts	3200 Starting Watts	23.3 Max Amps at 120V	10.1 Run Time at 25% Load w/ Smart Throttle (hrs)	67 Noise Level at 25% Load (dBA)
------------------------------	-------------------------------	---------------------------------	---	--

FEATURES



Key Fob Remote Start



Multi Functional Digital Display



Fuel Gauge



Extension Cord Management



Parallel Capable

BEST USED FOR



DIY Remodeling



One Room Backup



Camping



ACCESSORIES 2830536 INVERTER PARALLEL KIT
2830541 ALL WEATHER COVER

2884866 HIGH ALTITUDE MODIFICATION KIT
2879383 GENERATOR OIL

READ, UNDERSTAND AND FOLLOW YOUR OWNER'S MANUAL. Never operate a generator indoors. Generator exhaust contains carbon monoxide vapors and exposure can result in severe injury or death. Gasoline is highly flammable and explosive under certain conditions. Always use extreme care whenever handling gasoline.



P5500

Open Frame Generator

2830534

\$1,799 99

5000
Running
Watts

5500
Starting
Watts

20/30
Max Amps
at 120/240V

5
Run Time
(hrs)

75
Noise Level
(dBA)

FEATURES



Extension Cord Management



Fuel Gauge



Electric Start



Rough Terrain Wheel

BEST USED FOR



Construction



Home Backup



RV'ing



ACCESSORIES

2830542
2884867

ALL WEATHER COVER
HIGH ALTITUDE MODIFICATION KIT

2879383 GENERATOR OIL

P6500

Open Frame Generator

2830535

\$1,999 99

6000
Running
Watts

6500
Starting
Watts

20/30
Max Amps
at 120/240V

5
Run Time
(hrs)

75
Noise Level
(dBA)

FEATURES



Extension Cord Management



Fuel Gauge



Electric Start



Rough Terrain Wheel

BEST USED FOR



Construction



Home Backup



RV'ing



ACCESSORIES

2830542
2884867

ALL WEATHER COVER
HIGH ALTITUDE MODIFICATION KIT

2879383 GENERATOR OIL



NEW
OFF-ROAD RIDING JERSEYS

\$43⁹⁹

Mesh ventilated panels for maximum airflow
Elastic sleeves with non-restrictive cuffs

NEW
OFF-ROAD RIDING GLOVES

\$30⁹⁹

Adjustable wrist closure for a custom fit
Silicon finger grips and neoprene knuckle protection



TEKVEST® FREESTYLE

\$433⁹⁹

Black | S-3XL | 2862577



BLACK
JERSEY | S-3XL | 2862718
GLOVE | S-3XL | 2862726

YOUTH JERSEY
\$37⁹⁹
S-XL | 2862723

ORANGE
JERSEY | S-3XL | 2862719
GLOVE | S-3XL | 2862729

TEAL
JERSEY | S-3XL | 2862720
GLOVE | S-3XL | 2862727

YOUTH JERSEY
\$37⁹⁹
S-XL | 2862724

GREEN
JERSEY | S-3XL | 2862721
GLOVE | S-3XL | 2862730

BLUE
JERSEY | S-3XL | 2862722
GLOVE | S-3XL | 2862728

YOUTH JERSEY
\$37⁹⁹
S-XL | 2862725



SHORT SLEEVE
\$45⁹⁹
Men's | S-3XL | 2860634
Women's | S-3XL | 2860636



LONG SLEEVE
\$58⁹⁹
Men's | S-3XL | 2860638
Women's | S-3XL | 2860640



RAIN JACKET
\$129⁹⁹
Gray | S-3XL | 2869527



RAIN PANTS
\$109⁹⁹
Gray | S-3XL | 2869528

COOLING SHIRTS

FABRIC TECHNOLOGY DESIGNED TO KEEP YOU COOL

- Chemical-free fabric, Coolcore® reduces the surface temperature up to 30% so you don't overheat
- Carries a 50 Ultraviolet Protection Factor rating, blocking 98% of harmful UV rays



RAIN JACKET & PANTS

PACKABLE WATERPROOF PROTECTION AGAINST UNPREDICTABLE WEATHER

- 100% waterproof, lightweight and packable nylon
- YKK® zippers
- Rain jacket has removable hood

HELMETS

FOR
POLARIS

NEW
TAN
XS-4XL
2862472



ALTITUDE

509 ALTITUDE 2.0 HELMET

LIGHTWEIGHT DESIGN, PERFORMANCE-INFUSED STYLE AND FEATURES WITH ALL-DAY COMFORT

SHELL **\$371⁹⁵**

- Strong, lightweight construction of carbon fiber or fiberglass

WEIGHT

- Composite as low as 1,260g
- Carbon fiber as low as 1,150g

FEATURES

- Superior fit for all-day comfort
- Removable Pro Series breath box provides excellent ventilation and air flow
- One-piece eyepoint creates draft-free seal with 509 goggles
- Magnetic Fidlock® chin-strap technology and integrated GoPro® mount
- DOT- and ECE 22.05-approved

FIDLOCK



BLACK
XS-4XL
2861469

BLACK/RED
XS-4XL
2861472

RED/BLACK
XS-4XL
2861470

\$495⁹⁵
CARBON FIBER
BLACK/LIME
XS-4XL | 2861473

FOR
POLARIS

RED/BLACK
XS-4XL
2862467



TACTICAL

NEW TACTICAL 2.0 HELMET

BUILT FROM THE GROUND UP WITH INNOVATIVE FEATURES FOR ULTIMATE COMFORT AND CONTROL

SHELL **\$272⁹⁵**

- Shock-resistant, injection-molded thermoplastic

FEATURES

- Venturi vent system generates negative pressure at velocity and pulls moist air from the breath box
- Integrated eyepoint seal is co-integrated with the breath box and creates a draft-free seal with 509 goggles for unparalleled warmth and clear field of view
- Magnetic Fidlock® chin-strap technology
- DOT- and ECE 22.06-approved

FIDLOCK



MATTE BLACK
XS-4XL
2862468

GRAY
XS-4XL
2862469

LIME
XS-4XL
2862470

ORANGE
XS-4XL
2862471

TENACITY

TENACITY 4.0 HELMET

COMBINATION OF MODERN STYLE AND PREMIUM PROTECTION WITH INCREDIBLE VALUE

SHELL **\$173⁹⁹**

- Shock-resistant, injection-molded thermoplastic

WEIGHT

- 1,500g

FEATURES

- Through-flow, full-helmet ventilation
- ProClip quick release chin strap allows you to fasten the chin strap in seconds
- Removable breath box
- Tool-less adjustable roost shield
- Removable, washable liner
- DOT- and ECE 22.05-approved



LIME
XS-2XL
2861559



BLACK
XS-2XL
2861557

BLACK/GRAY
XS-2XL
2861558

BLACK/WHITE
XS-2XL
2861560

WHITE/RED
XS-2XL
2861561

PINK
XS-2XL
2861562

GOGGLES



ORANGE
2862561



LIME
2862559

NEW 509 KINGPIN OFF-ROAD GOGGLE

PREMIUM MATERIALS, ATTRACTIVE PRICE **\$61⁹⁵**

FEATURES

- Oversized spherical lens delivers optimal peripheral vision
- Metal tear-off posts provide strength and durability
- Quick-change technology allows you to run the best lens tint for conditions



BLUE
2862562



STEALTH
2862560

NEW 509 MX6 OFF-ROAD GOGGLE

SUPER WIDE FIELD OF VIEW, ENGINEERED FOR DIRT **\$123⁹⁵**

FEATURES

- PC outer lens with anti-scratch coating, and internal anti-fog coating
- Outriggers with latch system for quick lens change
- 45mm strap with silicone to hold strap in place



BLACK
2862557



RED/BLACK
2862558

APPAREL

RIDING GEAR

HELMETS & GOGGLES

MEN'S APPAREL

WOMEN'S APPAREL

MERCHANDISE

MEN'S APPAREL

BLACK
S-3XL | 2862569



NAVY
S-3XL | 2862570



NEW WORK VEST

RUGGED AND DURABLE VEST THAT'S IDEAL AS AN OUTDOOR LAYER

- Coated with Durable Water Repellency (DWR) to provide water-resistance
- 3M® Thinsulate® for added warmth with brushed flannel trim
- Three outer pockets for storage

\$123⁹⁹



CHARCOAL
S-3XL | 2860865



BRONZE
S-3XL | 2860864

FLANNEL JACKET

SHERPA FLEECE LINED JACKET DELIVERS EXCEPTIONAL WARMTH AND COMFORT

- Warm sherpa lined fleece material
- Insulation to keep you warm
- Plenty of storage for your valuables

\$123⁹⁹



FOREST GREEN
S-3XL | 2860862



GRAY
S-3XL | 2860863



BLACK
S-3XL | 2861608

WORK JACKET

WARM AND RUGGED JACKET THAT'S TOUGH FOR WORK AND STYLISH FOR PLAY

- Coated with Durable Water Repellency (DWR) to provide water-resistance
- Built in action back for increased range of motion
- 80g 3M® Thinsulate® for added warmth with brushed flannel trim
- One inner and four outer pockets for storage

\$198⁹⁹

NEW
RED
S-3XL | 2862451



BLACK
S-3XL | 2861434



GRAY
S-3XL | 2861435

SOFTSHELL JACKET

VERSATILE LIGHTWEIGHT JACKET THAT'S SURPRISINGLY WARM AND PERFECT FOR EVERYDAY WEAR

- Casual jacket armed with rugged and warm features for everyday wear
- Superior DWR prevents precipitation from saturating the jacket's exterior
- Lined with 280g of soft fleece for warmth
- Removable hood and underarm venting, three external pockets and one internal chest pocket

\$161⁹⁹

NEW REVOLVE VEST

REVERSIBLE

DURABLE AND WARM REVERSIBLE VEST OFFERS TWO STYLES IN ONE

- Durable windbreak outer fabric helps protect from the elements
- 140g 3M® Thinsulate® insulation keeps you warm in cold weather
- Reversible vest offers two unique styles in one

\$123⁹⁹



BLUE/ORANGE
S-3XL | 2862566

NEW WINDBREAKER JACKET

LIGHTWEIGHT, WINDPROOF JACKET THAT PROVIDES PROTECTION WHILE RIDING

- 100% polyester windproof fabric
- Lightweight construction makes it easy to pack
- Three external pockets allow for maximum storage

\$132⁹⁹

Black | S-3XL | 2861541



FORCE JACKET

PACKABLE JACKET OFFERS LIGHTWEIGHT PROTECTION, IDEAL FOR ANY ACTIVITY

- 140g 3M® Thinsulate®
- Plenty of storage with two external hand pockets and one internal media pocket
- Rugged YKK® zippers
- Great for travel, compacts into pocket

\$173⁹⁹

Black | S-3XL | 2861432



BLACK/GRAY
S-3XL | 2862565



APPAREL

RIDING GEAR

HELMETS & GOGGLES

MEN'S APPAREL

WOMEN'S APPAREL

MERCHANDISE

NEW
TITAN MID-LAYER

EXTREMELY WARM YET BREATHABLE MID-LAYER, PERFECT FOR RIDING

- 319g Polartec® Thermal Pro® rib sweater provides great warmth
- Quick drying moisture wicking helps keep you dry
- Breathable material moves sweat to the outer surface
- Nylon overlay is comfortable and light

\$111.99

BLACK
S-3XL | 2862568

BLUE/ORANGE
S-3XL | 2862567



NEW
TAN
S-3XL | 2862450

RED/BLACK
S-3XL | 2862490

NORTHSTAR MID-LAYER

VERSATILE MID-LAYER CAN BE WORN ALONE OR AS AN EXTRA LAYER

- 280g of breathable fleece for added warmth
- Offers durable protection against the elements with a wear-resistant polyester face and wind-block layer on chest
- Designed to fit under outer shell when riding

\$111.99

BLACK/RED
S-3XL | 2862616

BLACK/GRAY
S-3XL | 2869925

NEW
JOURNEY HOODIE

DURABLE HOODIE DESIGNED FOR EVERY DAY WEAR

- Keeps the elements out with snug, rib-knit waist and cuffs
- Mock neck collar provides added protection and warmth
- Durable blended material made of 80% cotton, 20% polyester

\$86.99

BLACK
S-3XL | 2862489



TECH FULL-ZIP HOODIE

\$80.99

NEW Tan | S-3XL | 2862486
Gray | S-3XL | 2861493
Black/Blue | S-3XL | 2861494



CREW SWEATSHIRT

\$61.99

NEW Black | S-3XL | 2862488
Green | S-3XL | 2861498
Navy | S-3XL | 2861497



ICON HOODIE

\$68.99

NEW Gray | S-3XL | 2862487
Green | S-3XL | 2861495
Black | S-3XL | 2861496



ICON LONG SLEEVE

\$37.99

NEW Gray/Red | S-3XL | 2862505
Black | S-3XL | 2861584
Blue | S-3XL | 2861585



DASH LONG SLEEVE

\$37.99

NEW Gray | S-3XL | 2862504
Navy | S-3XL | 2861583
Black | S-3XL | 2861582



CHECKERED LONG SLEEVE

\$37.99

NEW Red | S-3XL | 2862506
Gray | S-3XL | 2861587
Black | S-3XL | 2861586



ICON TEE

\$30.99

NEW Green | S-3XL | 2862501
Black | S-3XL | 2861570
Blue | S-3XL | 2861571



STAMP TEE

\$30.99

NEW Black | S-3XL | 2862496
Gray | S-3XL | 2861565
Green | S-3XL | 2861564



CORE TEE

\$30.99

NEW Red | S-3XL | 2862502
Black | S-3XL | 2861572
Blue | S-3XL | 2861573

MEN'S CAMO

STEALTH CAMO HAT

\$32⁹⁹

Camo | One Size | 2861527

NORTHSTAR MID LAYER

\$119⁹⁹

Camo | S-3XL | 2861542

CAMO SOFTSHELL JACKET

\$172⁹⁹

Camo | S-3XL | 2861543

MEN'S BALL CAPS

ELLIPSE PATCH TRUCKER HAT

\$32⁹⁹

NEW Light Gray | One Size | 2862539
 Gray | One Size | 2861531
 Black | One Size | 2861533
 Navy | One Size | 2861532

HIGHLAND CAP

\$30⁹⁹

Tan | One Size | 2860893
 Gray | One Size | 2862544

CORE CAP

\$32⁹⁹

NEW Gray | One Size | 2862594
 Navy | One Size | 2861523
 Black | One Size | 2861524

TONAL HAT

\$32⁹⁹

Black/Red | One Size | 2861526
 Navy | One Size | 2861525

CLASSIC CAP

\$30⁹⁹

Gray | One Size | 2862543
 Navy | One Size | 2862597



NEW

CAMO REVOLVE VEST

\$123⁹⁹

Camo | S-3XL | 2862572



NEW

PURSUIT HOODIE

\$61⁹⁹

Camo | S-3XL | 2862494



CAMO NECK GAITER

\$16⁹⁹

Camo | One Size | 2861948



CAMO TRUCKER HAT

\$32⁹⁹

Black | One Size | 2860613



HUNTER ORANGE HAT

\$30⁹⁹

Orange | S/M | 2860892
 Orange | L/XL | 2862545



HUNTER ORANGE BEANIE

\$24⁹⁹

Orange | One Size | 2862595



CHECKERED HAT

\$32⁹⁹

Blue | One Size | 2861520
 Black | One Size | 2861522
 Gray | One Size | 2861521



RETRO CAP

\$30⁹⁹

NEW Navy | One Size | 2862538
 Gray/Red | One Size | 2869542
 Gray/Orange | One Size | 2861536

APPAREL

RIDING GEAR

HELMETS & GOGGLES

MEN'S APPAREL

WOMEN'S APPAREL

MERCHANDISE

NEW
BLUE
S-3XL | 2862460



BLACK
S-3XL | 2862563



BLACK
S-3XL | 2861437

GRAY/BLUE
S-3XL | 2861439

BLUE
S-3XL | 2862564

SOFTSHELL JACKET

LIGHTWEIGHT PERFORMANCE THAT'S SURPRISINGLY WARM AND PERFECT FOR EVERYDAY WEAR

- Superior DWR prevents precipitation from saturating the jacket's exterior
- Lined with 280g of soft fleece for warmth
- Removable hood and underarm venting, three external pockets and one internal chest pocket

\$161⁹⁹



BLACK
S-3XL | 2862457

DUSTY ROSE
S-3XL | 2862456

BLACK
S-3XL | 2861433

REVOLVE VEST

DURABLE AND WARM REVERSIBLE VEST OFFERS TWO STYLES IN ONE

- Durable windbreak outer fabric protects you from the elements
- 140g 3M™ Thinsulate™ insulation keeps you warm in cold weather
- Reversible vest offers two unique styles in one

\$123⁹⁹

FORCE JACKET

PACKABLE JACKET OFFERS LIGHTWEIGHT PROTECTION, IDEAL FOR ANY ACTIVITY

- 140g 3M™ Thinsulate™
- Plenty of storage with two external hand pockets and one internal media pocket
- Rugged YKK® zippers
- Great for travel, compacts into pocket

\$173⁹⁹



BLACK/GRAY
S-3XL | 2862458

DUSTY ROSE
S-3XL | 2862459

TITAN MID-LAYER

EXTREMELY WARM YET BREATHABLE MID-LAYER, PERFECT FOR RIDING

- 319g Polartec® Thermal Pro® rib sweater provides great warmth
- Quick drying moisture wicking helps keep you dry
- Breathable material moves sweat to the outer surface
- Nylon overlay is comfortable and light

\$111⁹⁹

NEW WORK JACKET

WARM AND RUGGED JACKET THAT'S TOUGH FOR WORK AND STYLISH FOR PLAY

- Coated with DWR to provide water-resistance
- Built-in action back for increased range of motion
- 80g 3M™ Thinsulate™ for added warmth with brushed flannel trim
- One inner and four outer pockets for storage

\$198⁹⁹



NEW
PURSUIT HOODIE
~~\$61⁹⁹~~
Camo | S-3XL | 2862517



NEW JOURNEY HOODIE

\$86⁹⁹
Black | S-3XL | 2862515
Blue | S-3XL | 2862516

TECH FULL-ZIP HOODIE

\$80⁹⁹
Maroon | S-3XL | 2861509
Gray | S-3XL | 2861508

ICON HOODIE

\$68⁹⁹
NEW White | S-3XL | 2862512
Black | S-3XL | 2861506
Maroon | S-3XL | 2861507



NEW ADVENTURE CREW

\$61⁹⁹
Dusty Rose | S-3XL | 2862513
Black | S-3XL | 2862514

NEW ADVENTURE TEE

\$30⁹⁹
Teal | S-3XL | 2862629
Black Frost | S-3XL | 2862628

THINK OUTSIDE TEE

\$30⁹⁹
NEW Pink | S-3XL | 2862518
Black | S-3XL | 2861590
Blue | S-3XL | 2861591

MERCHANDISE



STEEL SIGN
14" x 36" | 2860868
\$168⁹⁹



ALUMINUM SIGN
22" | 2860867
\$168⁹⁹



WOOD SIGN
10.5" x 24" | 2860866
\$97⁹⁹



PINT GLASSES (SET OF 2)
2860815 | \$25⁹⁹



12oz CAMPER MUG
2861612 | \$39⁹⁹



17oz WATER BOTTLE
2861611 | \$32⁹⁹



NEW
23oz WATER BOTTLE
2862685 | \$30⁹⁹



15oz CAMPFIRE MUG
2861613 | \$26⁹⁹



KEYCHAIN
2861614 | \$8⁹⁹



LEATHER LOOP KEYCHAIN
2861615 | \$19⁹⁹



NEW
LICENSE PLATE HOLDER
2862687 | \$24⁹⁹



NEW
KICKBACK ROCKER
2862626 | \$68⁰⁰



NEW
FREESTYLE ROCKER
2862625 | \$81⁰⁰



NEW
EASY CHAIR
2862627 | \$56⁰⁰



NEW
QUICK-E-SEAT
2862624 | \$43⁰⁰



NEW
FOLDING TABLE
2861620 | \$66⁹⁹



NEW
POLARIS PARKING SIGN
2869934 | \$24⁹⁹



NEW
POLARIS FLAG
3' x 5' | 2869928 | \$30⁹⁹



NEW
HITCH COVER
2861623 | \$43⁹⁹



APPAREL

RIDING GEAR

HELMETS & GOGGLES

MENS APPAREL

WOMENS APPAREL

MERCHANDISE

FIND YOUR NEXT ADVENTURE



Warning: Polaris off-road vehicles can be hazardous to operate and are not intended for on-road use. Driver must be at least 16 years old with a valid driver's license to operate. All riders should always wear helmets, eye protection and protective clothing and footwear. Read, understand and follow your owner's manual. Ride within the limits of your own abilities and never engage in stunt or exhibition driving. Never ride under the influence of drugs or alcohol. All riders should take a safety training course. Call 800-342-3784 for additional information.

UNLESS NOTED, TRADEMARKS ARE THE PROPERTY OF POLARIS INDUSTRIES INC. 3M® and Thinsulate® are registered trademarks of 3M Company. 509® is a registered trademark of Teton Outfitters, LLC. Apple® is a registered trademark of Apple Inc. App Store® is a registered trademark of Apple Inc. BatteryMinder® is a registered trademark of VDC Electronics Inc. Bluetooth® is a registered trademark of Bluetooth SIG, Inc. Caliber® is a registered trademark of Caliber, Inc. Camoplast® is a registered trademark of CAMSO INC. COOLCORE® is a registered trademark of COOLCORE LLC. Facebook® is a registered trademark of Facebook, Inc. Fidlock® is a registered trademark of Fidlock GmbH. FOX® is a registered trademark of Fox Factory Inc. Google Play® is a registered trademark of Google, Inc. GoPro® is a registered trademark of GoPro, Inc. Instagram® is a registered trademark of Instagram, LLC. Kolpin® is a registered trademark of Polaris Industries Inc. Pandora® is a registered trademark of Pandora Media, LLC. Polartec® is a registered trademark of MMT-IPCO, LLC. RHINO-RACK® is a registered trademark of Rhino Rack Australia Pty Limited. RIGID® is a trademark of JST Performance, LLC d/b/a Rigid Industries. Rockford Fosgate® is a registered trademark of Rockford Corporation. SMART BOARD® is a registered trademark of MART TECHNOLOGIES ULC UNLIMITED LIABILITY CORPORATION CANADA. TEKVEST® is a registered trademark of 1181676 ONTARIO INC. Tiger Drylac® is a registered trademark of TIGER COATINGS GMBH & CO. Twitter® is a registered trademark of Twitter, Inc. WALKER EVANS RACING® is a registered trademark of Walker Evans Enterprises Incorporated. Yeti® is a registered trademark of Yeti Coolers, LLC. YKK® is a registered trademark of YKK Corporation. YouTube® is a registered trademark of Google Inc. Prices, Fitment and Availability are subject to change at any moment. Copyright © 2021 Polaris Industries Inc. All rights reserved.

BUILD THE MACHINE TO TAKE YOU THERE

Customize your GENERAL with exactly what you need to ride comfortably and explore farther than you've ever gone before.



STEP 1
CHOOSE MODEL



STEP 2
CHOOSE TRIM

STEP 3
CHOOSE COLOR

STEP 4 CHOOSE ACCESSORIES

EXPERIENCE OFF-ROAD LUXURY

- Windshield & Rear Panel P. 08
- Doors P. 10
- Roof P. 12
- Cab Comfort P. 17

NEXT LEVEL VERSATILITY

- Storage P. 16
- Lighting P. 26
- Wheels & Tires P. 28
- Winches P. 36

THE RIGHT STUFF TO MAINTAIN YOUR GENERAL

- Maintenance P. 38
- Oil & Lubricants P. 40

EVERYTHING YOU NEED TO GEAR UP

- Apparel P. 58
- Helmets P. 60

**BUILD YOUR OWN AT
POLARIS.COM/GENERAL**

ELEVATE YOUR ADVENTURE

GET THE BEST OWNER EXPERIENCE OUT THERE

Our goal is to make every day of ownership a smooth ride. Sign in for access to everything you need, plus exclusive offers and more.

[OFFROAD.POLARIS.COM/ACCOUNT](https://offroad.polaris.com/account)



MY GARAGE

- Vehicle Profile & Accessory Details
- Maintenance Schedules
- Schedule Service
- Manuals & Warranty Info



MY RIDES & COMMUNITY

- My Tracked Rides
- My Planned Routes & POIs
- My Community Activities & Events
- Explore Polaris Adventures



MY SHOPPING

- Recommended Accessories
- Purchase History
- My Dealer
- Access to Polaris Pros



CONNECT ONLINE
SEARCH "PolarisORV"



BUILD YOUR DREAM MACHINE & EXPLORE FARTHER

1 CHOOSE
MODEL

2 CHOOSE
TRIM

3 CHOOSE
COLOR

4 CHOOSE
ACCESSORIES

VISIT [POLARIS.COM/GENERAL](https://polaris.com/general)
TO SEE VEHICLE OPTIONS AND VIEW ACCESSORIES
ON YOUR NEW MACHINE FROM EVERY ANGLE!



POLARIS

MY22 GENERAL APP ACC CAN • 9948146