

CANADA VERSION

POLARIS

SPORTSMAN

2022

ACCESSORIES + APPAREL



FORGE YOUR OWN PATH



The ATV that defined the industry, SPORTSMAN combines legendary smoothness, unstoppable versatility and an ease of use that the competition continues to chase, which is why SPORTSMAN is chosen by more ATV owners. Whether you're tearing up the trails, working out in the fields, or navigating the wilderness for the perfect hunt, there is a SPORTSMAN story to be told.

2022 LINEUP

SEE THE FULL LINEUP AT [POLARIS.COM/SPORTSMAN](https://www.polaris.com/sportsman)

450 / 570

P. 14

RECREATION & UTILITY

TOURING

HUNT



SPORTSMAN 450 H.O.
(EPS, UTILITY)



SPORTSMAN 570
(EPS, PREMIUM,
UTILITY, TRAIL)



SPORTSMAN 570
UTILITY HD



SPORTSMAN TOURING
570 (EPS, PREMIUM)



SPORTSMAN 570
HUNT EDITION

WORK

RIDE COMMAND



SPORTSMAN 570 6X6



NEW
SPORTSMAN 570
RIDE COMMAND EDITION

850 / XP 1000 / XP 1000 S

P. 26

RECREATION & UTILITY

TOURING



SPORTSMAN
850 (PREMIUM)



SPORTSMAN
XP 1000 S



SPORTSMAN
TOURING 850



NEW
SPORTSMAN TOURING
XP 1000 TRAIL

HUNT

MUD

RIDE COMMAND

ULTIMATE TRAIL



SPORTSMAN XP 1000
HUNT EDITION



SPORTSMAN 850/XP 1000
HIGH LIFTER EDITION



NEW
SPORTSMAN XP 1000
RIDE COMMAND EDITION



SPORTSMAN 850
ULTIMATE TRAIL



NEW
SPORTSMAN XP 1000
ULTIMATE TRAIL

SCRAMBLER 850

P. 34

SPORT PERFORMANCE



SCRAMBLER 850

YOUTH

P. 36



OUTLAW 70 EFI

CONTENTS

MODEL YEAR 2022 02

CONNECTED TECHNOLOGY 08

WINCHES 12

450 / 570 14

WINCHES, PROTECTION & RACKS 16

COMFORT, AUDIO & STORAGE 18

WINDSHIELDS 20

570 6X6, 570 TOURING & 570 X2 22

2014-2020 MODELS 24

850 / XP 1000 / XP 1000 S 26

WINCHES, RACKS & PROTECTION 28

STORAGE, AUDIO & COMFORT 30

WINDSHIELDS 32

SCRAMBLER 850 / XP 1000 S 34

YOUTH: OUTLAW 70 EFI 36

COMMON ACCESSORIES 38

GLACIER PLOW SYSTEMS 38

TRACKS 40

WHEELS & TIRES 42

LIGHTING 48

HUNT 50

POLARIS NORTHSTAR COOLERS 52

PARTS & GARAGE 54

MAINTENANCE 54

OIL & LUBRICANTS 56

MAINTENANCE FLUIDS 58

BATTERIES & GARAGE ACCESSORIES 60

HD PARTS 62

SERVICE PARTS 64

TIRE SEALANT & TRAILERING 66

POLARIS POWER 68

APPAREL 74

RIDING GEAR 76

HELMETS & GOGGLES 78

MEN'S APPAREL 80

WOMEN'S APPAREL 86

MERCHANDISE 88

SHOP ALL SPORTSMAN ACCESSORIES AT
[POLARIS.COM/ShopSPORTSMAN](https://www.polaris.com/ShopSPORTSMAN)

MODEL YEAR 2022

TAKE YOUR SPORTSMAN
TO THE NEXT LEVEL

GO FURTHER

WITH YOUR SPORTSMAN AND
MAKE IT YOUR OWN WITH POLARIS
ENGINEERED ACCESSORIES



MOST POPULAR ADD-ONS

Racks	P. 28
Storage	P. 30
Windshields	P. 32
Wheels & Tires	P. 42

**RIDE COMMAND
EDITION**



MOST POPULAR ADD-ONS

Racks	P. 28
Storage	P. 30
Wheels & Tires	P. 42
Lighting	P. 48

**ULTIMATE
TRAIL**

DESIGNED

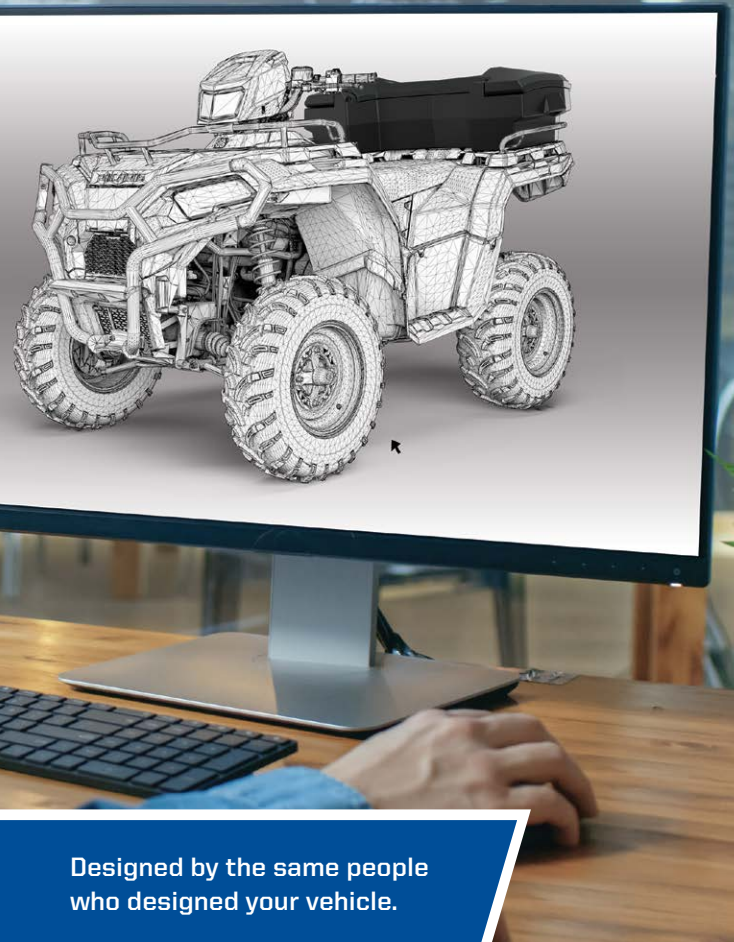

Designed by the same people who designed your vehicle.

TESTED



Extensively tested in the field so you ride with 100% confidence.

TRUSTED

ACCESSORIES
BACKED BY A



WARRANTY

65 years in the business.
The #1 name in Off-Road.



WE HOLD OUR PARTNERS TO THE SAME STANDARDS



WHEELS, TIRES & LIGHTING DESIGNED WITH POLARIS TO MAXIMIZE PERFORMANCE
P. 42, 48



A GLOBAL LEADER IN AUDIO INNOVATION, DESIGN & ENGINEERING
P. 19, 31



PRODUCTS SO GOOD THEY REPLACE OR REPAIR THEM FOR LIFE
P. 48



MAKING PRODUCTS FOR AVID SPORTSMEN SINCE 1943
P. 50



DIGITAL GAUGES FOR POWERSPORTS RIDERS
P. 09

ENGINEERED FOR MORE

Ensuring Polaris Engineered Accessories fit and work in sync with your machine is the most critical phase of testing and validation. With seamless integration, you can trust that any Polaris accessory you install will enhance your interaction beyond your expectations.



POLARIS RIDE COMMAND

PLAN. TRACK. SHARE. CONNECT.

Ride in confidence with industry-exclusive technology showing the way on the 7" Display Powered by RIDE COMMAND. Available on Ride Command Editions and as an accessory for 2022 SPORTSMAN models.



P. 08

LOCK & RIDE®

CARGO VERSATILITY

Lock & Ride mounting locations allow for limitless customization to let you work the way you want.

P. 19, 30



PRO PRO HEAVY DUTY SERIES

WINCHES

INTEGRATED WINCH MOUNT & PRE-WIRED

Designated mounting points and pre-wired contactors ensure a perfect fit and the strongest place to attach the Polaris Engineered winch - the most dependable winch for your SPORTSMAN. With wiring built right into the vehicle, we made this the easiest SPORTSMAN winch ever made to install.

P. 12

GLACIER® PLOW SYSTEM

INTEGRATED PLOW MOUNT

The attachment points for the Glacier® Plow System are integrated right at the factory and feature an innovative drive-up and go installation process.

P. 38

CONNECTED TECHNOLOGY



POLARIS RIDE COMMAND



PLAN. TRACK. SHARE. CONNECT.

PLAN YOUR RIDE

Plan an epic ride with stops along the way, customize and adjust your path to maximize your route or follow turn-by-turn directions. You can even share your planned route with friends.

FOLLOW THE GROUP

With Group Ride, you can ride at your own speed and keep fellow riders in sight on your map screen, even if you get split up. Because rides are meant to be shared.

DISCOVER NEW TRAILS

With almost 1,000,000 miles of trails available offline, you'll have the confidence to explore further, whether you have cellular coverage or not.

WORK SMARTER

Plow Mode automatically raises and lowers the plow depending on the gear you're in.



VOYAGER PRO

ADD ANY VEHICLE TO YOUR POLARIS GROUP RIDES

The Trail Tech Voyager Pro GPS seamlessly connects with 2020-2022 Polaris RIDE COMMAND 7" Displays. Join the group and ride.

THE CONNECTED RIDER'S GPS

Featuring Polaris Group Ride compatibility, custom maps, Bluetooth®, a 4" color touchscreen and full vehicle integration with gauges.

Model-specific kits available for all UTV, ATV, snow and motorcycle brands.

AVAILABLE ON RIDE COMMAND EDITION MODELS & AS AN ACCESSORY

7" DISPLAY POWERED BY RIDE COMMAND FALL AVAILABILITY

- **Bright, 7" touchscreen** visible in all conditions.
- **GPS Navigation & Pre-Loaded Maps**
Available offline on your display so you always know where you are.
- **Route Planning**
Add points of interest and waypoints to make the most of your off-road adventure.
- **Group Ride**
"Follow the Leader" lets you set and follow the group leader on your display. Group Ride Messaging, lets you send messages to your group with or without a cellular signal.

- **Configurable Gauges**
Customize your ride experience with elevation, travel direction, fuel level and more to create relevant screens for you.
- **Personalized Audio Experience**
Seamlessly pair your display via Bluetooth® to wirelessly stream music and stay connected with call and text alerts. Add the Lock & Ride Rear Audio Storage Box to stream music. (Requires Lock & Ride Rear Audio Storage Box and Rear Power Harness.)

- **Industry's Only Plow Mode**
Quick and easy plowing. Plow automatically lowers when shifted into low gear and raises when shifted into reverse. (Requires Polaris Winch with Auto Stop Technology and Synthetic Rope. Learn more on P. 12.)
- **Display Mount Kit Included**
Comes with required wiring harnesses and accessory components. Includes V2V and GPS antenna.

» 2889455 • \$1,934⁹⁹
SPORTSMAN 450/570 '22, SPORTSMAN 850/1000 '22

VOYAGER PRO KIT, ATV

- **Bright, 4" touchscreen** visible in all conditions.
- **Pre-Loaded Base Maps**
The map screen is enabled with base maps, topography lines, hill shading and select trails. Record or load GPS trails/riding areas and transfer to a PC.
- **Buddy Tracking**
Track up to 20 group members no matter what type of vehicle they are riding.
- **Bluetooth® Enabled**
Bluetooth® enabled for intercom, phone and media controls. Play songs from your phone or MicroSD card using a Bluetooth® headset, speaker or intercom. Two phones and two headsets can be connected at the same time.

» MODEL-SPECIFIC KITS • \$779⁹⁹
AVAILABLE AT YOUR LOCAL DEALER OR ONLINE AT TRAILTECH.NET



LEARN MORE AND DOWNLOAD AT
[RIDECOMMAND.POLARIS.COM](https://ridecommand.polaris.com)



[POLARIS.COM/ShopSPORTSMAN](https://polaris.com/shop/sportsman)

LEARN MORE AT
[TRAILTECH.NET](https://trailtech.net)



SUPERIOR INTEGRATION

POLARIS
ENGINEERED

Right from the factory, your vehicle is built to make essential accessories like winches and plows easy to use day-in and day-out. Mounting brackets are designed into the oversized factory bumper and wiring is routed securely and properly. When it comes to SPORTSMAN, Polaris Engineered Accessories make work easier so you can get more done.

POLARIS ENGINEERED WINCHES

- ✓ Tested 1,200+ pulls at max load, it works when you need it to
- ✓ Built for winter, withstands -20° F temperatures
- ✓ Pre-wired chassis
Factory-installed wiring makes the controls simple to install. Mount the winch, connect the wires and trust that everything is routed safely, securely, and properly.
- ✓ No need to cut panels
- ✓ Sealed motor and heavy-duty gears operate fully submerged underwater
- ✓ Military tested and approved

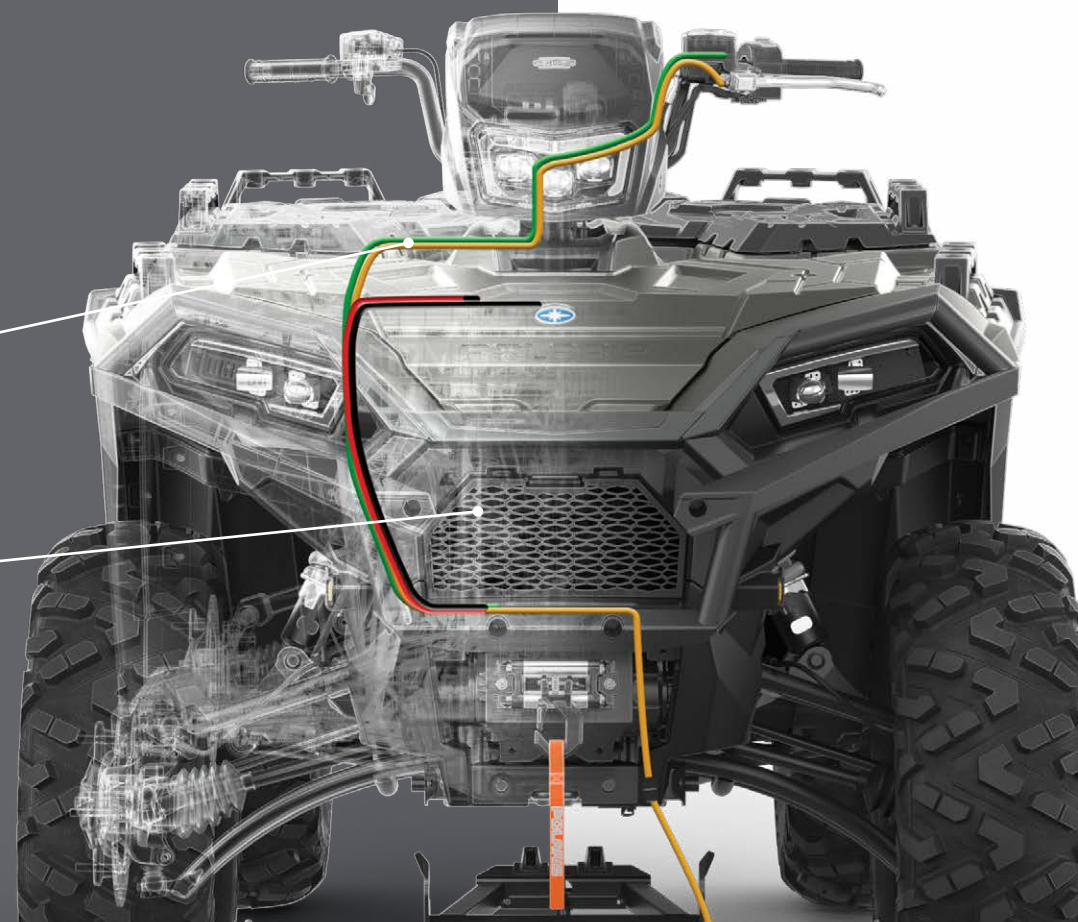

GLACIER PLOW SYSTEM

- ✓ Easily engage and disengage the plow system from your SPORTSMAN
- ✓ No loss of factory ground clearance when not plowing
- ✓ Don't have to crawl under the machine to release the plow blade from the vehicle
- ✓ No trimming of vehicle plastic required to mount plow or winch

TO LEARN MORE ABOUT POLARIS ENGINEERED WINCHES, SEE P. 12

TO LEARN MORE ABOUT THE GLACIER PLOW SYSTEM, SEE P. 38

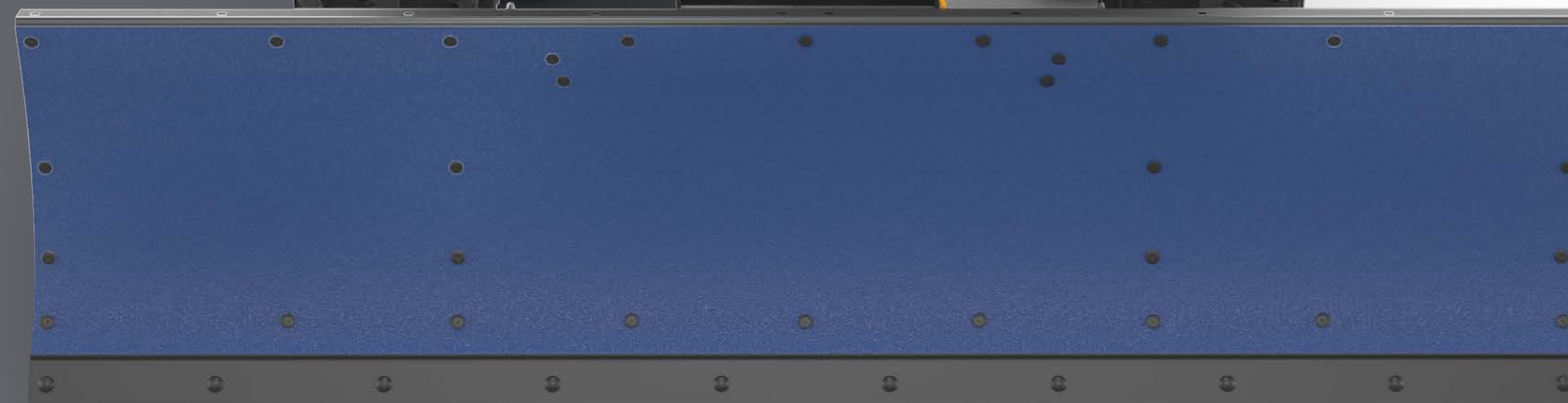

WINCHES



ADD A PLOW
P. 38

DEPENDABLE. TOUGH. BUILT FOR THE OFF-ROAD.

A Polaris Engineered winch is designed to help you get the job done right, get you on your way faster and prepare you for the unexpected.

WHY POLARIS?

Polaris off-road vehicles are engineered with designated mounting points and wiring for seamless install of Polaris Engineered winches.



TESTED **1,200+**
PULLS AT MAX LOAD



BUILT TO WITHSTAND
-20° F TEMPERATURES



OPERATES FULLY
SUBMERGED



MILITARY
TESTED & APPROVED

REPLACEMENT PART



REPLACEMENT STEEL CABLE

- 2,500 winch series - 50 ft.
- » 2878890 • \$59⁹⁹



RECOVERY STRAP

- 2" x 30' (18,000 lb.)
- Comes with carry bag
- » 2884033 • \$74⁹⁹

FEATURES & BENEFITS

ALL POLARIS ENGINEERED WINCHES COME WITH:



WARRANTY

- ✓ INTEGRATED WIRING, MOUNT, PREASSEMBLED
- ✓ HOOK WITH STRAP
- ✓ CUT STEEL GEARS & SEALED DRIVETRAIN
- ✓ SEALED PERMANENT MAGNET MOTOR



Retrieve cable 5x as fast as standard mode on other Polaris winches. Get back to riding or complete your task quicker.

1. Set winch dial to N (Neutral) to manually pull the rope out and secure the hook to your anchor point
2. Set winch dial to L (Low) for maximum pulling power while winching your load
3. Set winch dial to H (High) for retrieving the rope 5x faster with Rapid Rope Recovery

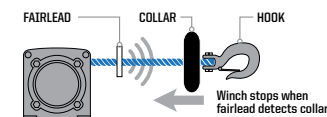

Auto Stop technology protects and extends the life of your winch by automatically stopping the winch at the end of pull to prevent over-spooling. While plowing, it prevents the plow frame from bending by stopping the winch once the plow has been lifted.



With its lightweight, yet extremely strong, design and superior flexibility, this 50 ft. long synthetic rope is easy to handle and can stand up to any tough job.



This convenient remote operates your Polaris winch wirelessly from within 50 ft. of the vehicle. Operate your winch safely outside your vehicle while on the job site or trails.

MODEL

450 H.O. '21-22
570 '21-22

450 H.O. '16-20
570 '14-20
X2 570 '15-21
TOURING 570 '14-21
6X6 570 '17-21

850 '12-22
XP 1000 '15-22
TOURING XP 1000 '15-22
TOURING 850 '15-22
SCRAMBLER 850 '14-22

SPORTSMAN XP 1000 S '20-22
SCRAMBLER XP 1000 S '20-21

PRO PRO HEAVY DUTY SERIES

TOP-OF-THE-LINE FEATURES

BEST FOR PLOWING, HEAVY-DUTY OUTDOOR CHORES & TRAIL RIDING



PRO PRO HEAVY DUTY SERIES

HD HEAVY DUTY SERIES

BUILT FOR THE OFF-ROAD

BEST FOR THE CASUAL OFF-ROAD RIDER



HD HEAVY DUTY SERIES



ADD AUTO STOP TECHNOLOGY



2881693 • \$134⁹⁹
SYNTHETIC ROPE REQUIRED
FITS WINCHES: 2880434, 2880432



2889253 • \$139⁹⁹
SYNTHETIC ROPE REQUIRED
FITS WINCHES: 2884832, 2884833, 2889469, 2889470



ADD SYNTHETIC ROPE
2878888 • \$104⁹⁹



ADD WIRELESS WINCH REMOTE

2879316 • \$179⁹⁹

3,500 LB.
with Synthetic Rope

TOP SELLER
2884834
\$709⁹⁹

3,500 LB.
with Synthetic Rope

TOP SELLER
2884833
\$599⁹⁹

2,500 LB.
with Steel Cable

TOP SELLER
2884832
\$519⁹⁹

TOP SELLER
2880434
\$609⁹⁹

TOP SELLER
2880432
\$509⁹⁹

NEW
2889471
\$709⁹⁹

NEW
2889470
\$599⁹⁹

NEW
2889469
\$519⁹⁹

2883580
\$709⁹⁹

COMFORT ESSENTIALS



Polaris Pro HD 3,500 lb. Winch	P. 16	LED Light Kit	P. 18	Pro Armor Wheel & Tire Set: Dual Threat/4202	P. 47
Trail Brushguard	P. 16	Rear Power Harness	P. 18	Lug Nuts	P. 47
Rear Brushguard	P. 16	LOCK & RIDE Rear Audio Storage Box	P. 19	RIGID® D-Series Pro Driving LED Light	P. 48
Rear Rack Extender	P. 17	Audio Storage Box Remote	P. 19	Lightbar Harness	P. 49
Handguards	P. 18	LOCK & RIDE Pod Bag	P. 19	LED Y-Harness	P. 49
Handguard Mount	P. 18	LOCK & RIDE Fender Bag	P. 19		

HUNTER



Polaris HD 3,500 lb. Winch	P. 16	LOCK & RIDE Tall Windshield	P. 20	Lightbar Harness	P. 49
HD Front Brushguard with Hitch	P. 16	Pro Armor Wheel & Tire Set: Mud XC/4205	P. 47	Gun Boot L	P. 50
Rear Rack Extender	P. 17	Lug Nuts	P. 47	Stronghold Auto-Latch Mount	P. 50
Hand & Thumb Warmer Kit	P. 18	RIGID® SR-Series 10" Combo LED Light	P. 49	LOCK & RIDE Rhino Grip Pro	P. 50

WORK HARD AND GET IT DONE with Polaris Engineered Accessories. Find everything you need to outfit your trusted partner for the task at hand.

WORKER



Polaris HD 2,500 lb. Winch	P. 16	Rear Rack Extender	P. 17	LOCK & RIDE Open Cargo Box	P. 19
Rear Brushguard	P. 16	Front Utility Rack	P. 17	LOCK & RIDE Mid Windshield	P. 20
HD Front Brushguard with Hitch	P. 16	Rear Utility Rack	P. 17	Pro Armor Wheel & Tire Set: Harvester/4204	P. 47
Body Armor	P. 17	Rear Power Harness	P. 18	Lug Nuts	P. 47

WINTER



Polaris Pro HD 3,500 lb. Winch	P. 16	LOCK & RIDE Rear Cargo Box	P. 19	Glacier Pro Plow Blade - 66" Poly	P. 39
HD Front Brushguard with Hitch	P. 16	LOCK & RIDE Tall Windshield	P. 20	RIGID® SR-Series 10" Combo LED Light	P. 49
Rear Rack Extender	P. 17	Glacier Integrated Plow Mount	P. 39	Lightbar Harness	P. 49
Hand & Thumb Warmer Kit	P. 18	Glacier Pro Steel ATV Plow Frame	P. 39		

2022 SPORTSMAN 450 • 570



WINCHES

POLARIS PRO HD 3,500 LB. WINCH TOP SELLER

- Adds 3,500 lbs of pulling capacity with Auto Stop Technology for plowing applications
- Rapid Rope Recovery recovers open cable 5x as fast as standard mode on other Polaris winches

» 2884834 • \$709⁹⁹
SPORTSMAN 450/570 '21-22



LEARN MORE ON P. 12

POLARIS HD 3,500 LB. WINCH TOP SELLER

- Adds 3,500 lbs of pulling capacity with quick and easy installation
- Includes all components required for installation plus 50 ft. of 3/16" premium high-strength synthetic rope

» 2884833 • \$599⁹⁹
SPORTSMAN 450/570 '21-22



POLARIS HD 2,500 LB. WINCH TOP SELLER

- Adds 2,500 lbs of pulling capacity with quick and easy installation
- Includes all components required for installation plus 50 ft. of 3/16" high-strength steel cable

» 2884832 • \$519⁹⁹
SPORTSMAN 450/570 '21-22



NEED A PLOW? SEE P. 38

PROTECTION

TRAIL BRUSHGUARD TOP SELLER

- Provides enhanced protection from brush and debris
- Has designated light bar holes and is compatible with winch and Body Armor

» 2884844 • \$259⁹⁹
SPORTSMAN 450/570 '21-22



REAR BRUSHGUARD TOP SELLER

- Protect your vehicle from brush, sticks, rocks and light bumps into solid objects
- Made of sturdy 1.25" steel tube with a matte black finish

» 2884847 • \$234⁹⁹
SPORTSMAN 450/570 '21-22



HD FRONT BRUSHGUARD WITH HITCH

- Adds heavy-duty protection with a custom look
- Has designated light bar holes and is compatible with winch and Body Armor
- Standard front receiver hitch for additional functionality

» 2884850 • \$425⁹⁹
SPORTSMAN 450/570 '21-22



RACKS

REAR RACK EXTENDER TOP SELLER

- Forms a 3" tall perimeter around the rear cargo rack to keep gear secure which maximizes your cargo capabilities
- Durable steel construction provides a sturdy tie down anchor for loose gear
- Compatible with Cargo Boxes and Rear Utility Rack

» 2884841 • \$129⁹⁹
SPORTSMAN 450/570 '21-22



FRONT UTILITY RACK TOP SELLER

- Tubular steel rack that attaches on top of front plastic rack providing protection and multiple tie down points
- 3/4" diameter matte black steel tube

» 2884842 • \$169⁹⁹
SPORTSMAN 450/570 '21-22



REAR UTILITY RACK TOP SELLER

- Replaces rear plastic rack with a strong flat steel rack with integrated tie down points
- Works with all Lock & Ride accessories, rack extenders, and gun mounts

» 2884843 • \$269⁹⁹
SPORTSMAN 450/570 '21-22



BODY ARMOR

- Provides extra protection to your ATV's full body and fenders

» 2884851 • \$389⁹⁹
SPORTSMAN 450/570 '21-22
Front bumper (2884850 or 2884844) required for installation



SKID PLATE

- Built to be tough from 10mm thick high-density polyethylene

» 2884852 • \$519⁹⁹
SPORTSMAN 450/570 '21-22



2022 SPORTSMAN 450 • 570



COMFORT



HANDGUARDS

<input type="checkbox"/> BRIGHT WHITE	2876883	\$55 ⁹⁹
<input checked="" type="checkbox"/> BLACK <small>TOP SELLER</small>	2876846	\$55 ⁹⁹
<input type="checkbox"/> INDY RED	2876845	\$55 ⁹⁹

- Handguard Mount (2889341) is required when installing Polaris Handguards
- Does not fit with windshields or Handlebar Mounted Mirrors

NEW
» 2889341 • MOUNT • \$43⁹⁹
SPORTSMAN 450/570 '21-22



HAND & THUMB WARMER KIT TOP SELLER

- Provides heat to grips and throttle and is easily installed by plugging into pod
 - Includes two heated grips and one throttle warmer
- » 2885002 • \$129⁹⁹
SPORTSMAN 450/570 '21-22



HANDLEBAR MOUNTED MIRRORS TOP SELLER

- Enhances visibility of what's behind you for added safety
 - Sold as a pair
 - Does not fit with windshields or Handguards
- » 2877222 • \$54⁹⁹
SPORTSMAN 450/570 '21-22



LED LIGHT KIT

- Upgrade your standard headlights and pod lights to LEDs with this upgrade kit
- » 2884859 • \$519⁹⁹
SPORTSMAN 450/570 '21-22



REAR POWER HARNESS

- Provides power to the rear of the ATV for electrical accessories including Rear Audio Storage Box
- » 2889070 • \$109⁹⁹
SPORTSMAN 450/570 '21-22

AUDIO



LOCK & RIDE REAR AUDIO STORAGE BOX

- Dual 6" speakers by Rockford Fosgate® that connect via Bluetooth®
 - Mounts easily with Lock & Ride to the rear rack and is compatible with rack extenders, utility rack, and gun mount
 - Rest easy knowing that your speakers are protected with a sealed-lid container
 - Rear Power Harness required for installation (2889070)
- » 2884856 • \$779⁹⁹
SPORTSMAN 450/570 '21-22



AUDIO STORAGE BOX REMOTE

- Easily control the volume or switch to the next song on your Rear Audio Storage Box
 - Conveniently mounts to your ATV's handlebars
- » 2884987 • \$129⁹⁹
SPORTSMAN 450/570 '21-22

STORAGE



NEW POD BAG

- Keep your essentials in reach with 2 Liters of storage capacity
 - Mounts to the top of the light pod with HD Velcro®
 - Semi-rigid construction and PU Laminated EVA material keeps belongings protected from the elements
 - Compatible with windshields
- » 2889286 • \$94⁹⁹
SPORTSMAN 450/570 '21-22



NEW FENDER BAG

- Provides easy-access 8.3 Liters of storage
 - Mounts to the front left fender with HD Velcro®
 - Semi-rigid construction and PU Laminated EVA material keeps belongings protected from the elements
- » 2889287 • \$169⁹⁹
SPORTSMAN 450/570 '21-22



NEW REAR RACK EXTENDER BAGS

- Three bags included (Rear Rack Extender sold separately)
 - Mounts to Rear Rack Extender with HD Velcro®
 - Add a convenient 1 Liter of storage without sacrificing the rear rack
 - Made to withstand the elements and wear with durable ballistic nylon construction (1680 Nylon and 600D SPD)
 - Rear Rack Extender (2884841) is required
- » 2889411 • \$144⁹⁹
SPORTSMAN 450/570 '21-22

NEW UNDERSEAT BAG

- Provides an extra 8.3 Liters of storage capacity
 - Mounts directly under your seat via a Velcro® wrap
 - Durable semi-rigid construction keeps items protected
- » 2889454 • \$109⁹⁹
SPORTSMAN 450/570 '21-22



LOCK & RIDE REAR CARGO BOX

- Increase your storage with an extra 21.25 gallons of dry, dust-proof storage
 - Mounts easily with Lock & Ride to the rear rack and is compatible with rack extenders, utility rack, and gun mount
 - Includes 2 padlock locations
- » 2884853 • \$414⁹⁹
SPORTSMAN 450/570 '21-22



LOCK & RIDE OPEN CARGO BOX

- Increase your storage with an extra 22 gallons of convenient storage space
 - Mounts easily with Lock & Ride to the rear rack and is compatible with rack extenders, utility rack, and gun mount
 - Holds two 5-gallon buckets with integrated grab handle to make it easy to carry and transport cargo
 - 12 convenient tie-down locations to secure cargo
- » 2884854 • \$269⁹⁹
SPORTSMAN 450/570 '21-22



LOCK & RIDE REAR COOLER BOX

- Increase your storage with an extra 46 quarts of weather resistant cooler storage
 - Mounts easily with Lock & Ride to the rear rack and is compatible with rack extenders, utility rack, and gun mount
 - Integrated bottle opener and 2 padlock locations
- » 2884857 • \$519⁹⁹
SPORTSMAN 450/570 '21-22



2022 SPORTSMAN 450 • 570



DO MORE

WINDSHIELDS

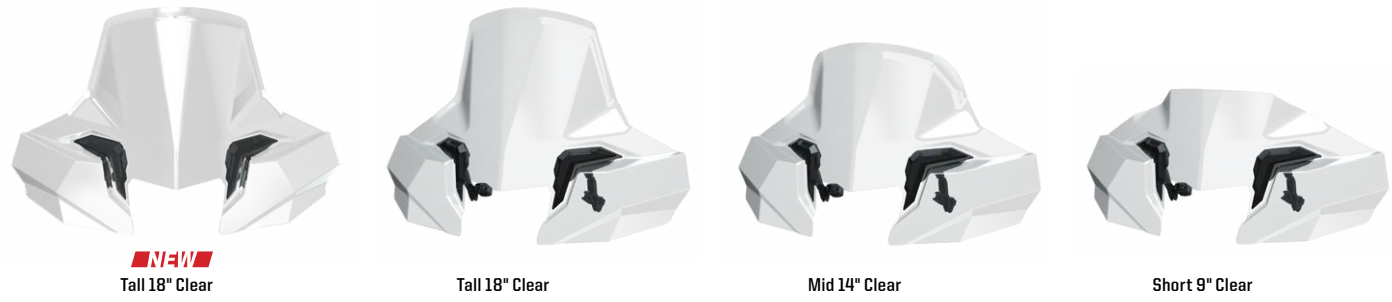

LOCK & RIDE WINDSHIELDS

- Lock & Ride technology allows for easy installation and removal in seconds without tools
- Poly windshields are flexible, impact-resistant, and provide long-term value over the life of your machine
- Three heights available for whatever coverage you prefer
- Does not work with Handguards or Handlebar Mounted Mirrors

SIZE	COLOR	PART #	PRICE
TALL 18"	CLEAR	2884945	\$234 ⁹⁹
MID 14"	CLEAR	2884845	\$219 ⁹⁹
SHORT 9"	CLEAR	2884946	\$209 ⁹⁹

SPORTSMAN 450/570 '21-22

NEW FALL AVAILABILITY

TALL 18"	CLEAR	2889491	\$234 ⁹⁹
----------	-------	---------	---------------------

SPORTSMAN 450/570 '22 WITH 7" DISPLAY INSTALLED



PLOWS P. 38



LIGHTING P. 48



WHEELS & TIRES P. 42



HUNT P. 50



SPORTSMAN

2014-2021
570 X2

2014-2022
570 6X6

570 TOURING



WINCHES

POLARIS HD 3,500 LB. WINCH TOP SELLER

» 2880434 • \$609⁹⁹
X2 570 '15-21, TOURING 570 '14-22, 6X6 570 '17-22



POLARIS HD 2,500 LB. WINCH TOP SELLER

» 2880432 • \$509⁹⁹
X2 570 '15-21, TOURING 570 '14-22, 6X6 570 '17-22



NEED A PLOW? SEE P. 38

STORAGE



SEMI-RIGID TOURING CARGO BAG

- Large-capacity, heavy-duty vinyl bag
- Three zippered openings, removable dividers
- Attaches to rack with Velcro® straps

» 2877220 • \$209⁹⁹
TOURING 570 '14-22

COMFORT



HAND WARMERS TOP SELLER

» 2877363 • \$79⁹⁹
X2 570 '15-21, TOURING 570 '14-22, 6X6 570 '17-22



THROTTLE/THUMB WARMER TOP SELLER

» 2877364 • \$64⁹⁹
X2 570 '15-21, TOURING 570 '14-22, 6X6 570 '17-22

HANDGUARDS

- BRIGHT WHITE 2876883 \$55⁹⁹
- BLACK TOP SELLER 2876846 \$55⁹⁹
- INDY RED 2876845 \$55⁹⁹



- Handguard Mount (2889341) is required when installing Polaris Handguards
- Does not fit with windshields or Handlebar Mounted Mirrors

» 2889341 • MOUNT • \$43⁹⁹
X2 570 '15-21, TOURING 570 '14-22, 6X6 570 '17-22



HANDLEBAR MOUNTED MIRRORS TOP SELLER

- Enhances visibility of what's behind you for added safety
- Sold as a pair
- Does not fit with Windshield Fairing or Handguards

» 2877222 • \$54⁹⁹
X2 570 '15-21, TOURING '570 14-22, 6X6 570 '17-22

PROTECTION, RACKS & WINDSHIELDS



FRONT BRUSHGUARD TOP SELLER

» 2879714 • \$249⁹⁹
X2 570 '15-21, TOURING 570 '14-22, 6X6 570 '17-22



REAR BRUSHGUARD

» 2879715 • \$229⁹⁹
TOURING 570 '14-22



ULTIMATE SERIES FRONT RACK EXTENDER 4" TOP SELLER

» 2879716 • \$134⁹⁹
X2 570 '15-21, TOURING 570 '14-22, 6X6 570 '17-22



LOCK & RIDE YUKON ADVENTURE RACK

- Adds increased storage volume by allowing you to increase storage height securely

» 2882084 • \$409⁹⁹
6X6 570 '17-22

LOCK & RIDE WINDSHIELDS

- Lock & Ride technology allows for easy installation and removal in seconds without tools
- Poly windshields are flexible, impact-resistant, and provide long-term value over the life of your machine
- Does not work with Handguards

SIZE	COLOR	PART #	PRICE
TALL 19.25"	CLEAR	2880539-409	\$219 ⁹⁹
MID 15.5"	SMOKE	2880540-412	\$209 ⁹⁹

X2 570 '18-21, TOURING 570 '18-22



Tall 19.25" Clear



Mid 15.5" Smoke

2014-2020 SPORTSMAN 450 • 570

WINCHES

POLARIS HD 3,500 LB. WINCH TOP SELLER

» 2880434 • \$609⁹⁹
450/570 '14-20



POLARIS HD 2,500 LB. WINCH TOP SELLER

» 2880432 • \$509⁹⁹
450/570 '14-20



NEED A PLOW? SEE P. 38

PROTECTION



FRONT BRUSHGUARD TOP SELLER

» 2879714 • \$249⁹⁹
450/570 '14-20



REAR BRUSHGUARD

» 2879715 • \$229⁹⁹
450/570 '14-20

RACKS



ULTIMATE SERIES FRONT RACK EXTENDER 4" TOP SELLER

» 2879716 • \$134⁹⁹
450/570 '14-20

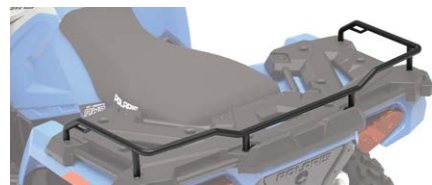

ULTIMATE SERIES REAR RACK EXTENDER 4" TOP SELLER

» 2879717 • \$149⁹⁹
450/570 '14-20

STORAGE

LOCK & RIDE REAR CARGO BOX

- Increase your storage with an extra 25 gallons of capacity
- Store two full-size helmets
- Works with Rack Extenders
- Will not fit when Utility Rack is installed

» 2882882 • \$409⁹⁹
450/570 '14-20



COMFORT



HAND WARMERS TOP SELLER

» 2877363 • \$79⁹⁹
450/570 '14-20



THROTTLE/THUMB WARMER TOP SELLER

» 2877364 • \$64⁹⁹
450/570 '14-20



HANDGUARDS

<input type="checkbox"/> BRIGHT WHITE	2876883	\$55 ⁹⁹
<input checked="" type="checkbox"/> BLACK <small>TOP SELLER</small>	2876846	\$55 ⁹⁹
<input type="checkbox"/> INDY RED	2876845	\$55 ⁹⁹

- Handguard Mount (2889341) is required when installing Polaris Handguards
- Does not fit with windshields or Handlebar Mounted Mirrors

NEW
» 2889341 • MOUNT • \$43⁹⁹
450/570 '14-20



HANDLEBAR MOUNTED MIRRORS TOP SELLER

- Enhances visibility of what's behind you for added safety
- Sold as a pair
- Does not fit with windshields or Handguards

» 2877222 • \$54⁹⁹
450/570 '14-20

WINDSHIELDS

LOCK & RIDE WINDSHIELDS

- Lock & Ride technology allows for easy installation and removal in seconds without tools
- Poly windshields are flexible, impact-resistant, and provide long-term value over the life of your machine
- Does not fit with Handguards or Handlebar Mounted Mirrors

SIZE	COLOR	PART #	PRICE
TALL 19.25"	CLEAR	2880539-409	\$219 ⁹⁹
MID 15.5"	SMOKE	2880540-412	\$209 ⁹⁹

450/570 '14-20



Tall 19.25" Clear



Mid 15.5" Smoke

COMFORT ESSENTIALS



NEW Polaris Pro HD 3,500 lb. Winch	P. 28	LOCK & RIDE Rear Audio Storage Box	P. 31	Pro Armor Wheel & Tire Set: Dual Threat/4202	P. 47
Ultimate Series Rear Rack Extender	P. 28	Audio Storage Box Remote	P. 31	Lug Nuts	P. 47
Ultimate Series Front Brushguard	P. 29	Handguards	P. 31	RIGID® D-Series Pro Driving LED Light	P. 48
Ultimate Series Rear Brushguard	P. 29	Handguard Mount	P. 31	Lightbar Harness	P. 49
NEW Pod Bag	P. 30	Rear Power Harness	P. 31	LED Y-Harness	P. 49

HUNTER



NEW Polaris HD 3,500 lb. Winch	P. 28	LOCK & RIDE Tall Windshield	P. 32	Lightbar Harness	P. 49
Ultimate Series Rear Rack Extender	P. 28	Pro Armor Wheel & Tire Set: Mud XC/4205	P. 47	Gun Boot L	P. 50
Ultimate Series Front Brushguard	P. 29	Lug Nuts	P. 47	Stronghold Auto-Latch Mount	P. 50
Hand & Thumb Warmer Kit	P. 31	RIGID® SR-Series 10" Combo LED Light	P. 49	LOCK & RIDE Rhino Grip Pro	P. 50

WORK HARD AND GET IT DONE with Polaris Engineered Accessories. Find everything you need to outfit your trusted partner for the task at hand.

WORKER



NEW Polaris HD 2,500 lb. Winch	P. 28	Ultimate Series Rear Brushguard	P. 29	LOCK & RIDE Mid Windshield	P. 32
Ultimate Series Rear Rack Extender	P. 28	Ultimate Series Body Armor	P. 29	Pro Armor Wheel & Tire Set: Harvester/4204	P. 47
Ultimate Series Front Steel Rack	P. 29	LOCK & RIDE Open Cargo Box	P. 30	Lug Nuts	P. 47
Ultimate Series Front Brushguard	P. 29	Rear Power Harness	P. 31		

WINTER



NEW Polaris Pro HD 3,500 lb. Winch	P. 28	Hand & Thumb Warmer Kit	P. 31	Glacier Pro Plow Blade - 66" Poly	P. 39
Ultimate Series Rear Rack Extender	P. 28	LOCK & RIDE Tall Windshield	P. 32	RIGID® SR-Series 10" Combo LED Light	P. 49
Ultimate Series Front Brushguard	P. 29	Glacier Integrated Plow Mount	P. 39	Lightbar Harness	P. 49
LOCK & RIDE Rear Cargo Box	P. 30	Glacier Pro Steel ATV Plow Frame	P. 39		

SPORTSMAN 850 XP 1000 XP 1000 S



WINCHES

POLARIS PRO HD 3,500 LB. WINCH

» 2883580 • \$709⁹⁹
SPORTSMAN XP 1000 S '20-22



NEW
» 2889471 • \$709⁹⁹
SPORTSMAN 850 '12-22, SPORTSMAN XP 1000 '15-22,
SPORTSMAN TOURING XP 1000 '15-22,
SPORTSMAN TOURING 850 '15-22



RAPID ROPE RECOVERY



LEARN MORE ON P. 12

POLARIS HD 3,500 LB. WINCH

» 2889470 • \$599⁹⁹
SPORTSMAN 850 '12-22, SPORTSMAN XP 1000 '15-22,
SPORTSMAN TOURING XP 1000 '15-22,
SPORTSMAN TOURING 850 '15-22



POLARIS HD 2,500 LB. WINCH

» 2889469 • \$519⁹⁹
SPORTSMAN 850 '12-22, SPORTSMAN XP 1000 '15-22,
SPORTSMAN TOURING XP 1000 '15-22,
SPORTSMAN TOURING 850 '15-22



NEED A PLOW? SEE P. 38

POLARIS.COM/ShopSPORTSMAN

RACKS

ULTIMATE SERIES RACK EXTENDER 4"

FRONT

» 2882022 • \$134⁹⁹
SPORTSMAN XP 1000 S '20-22,
SPORTSMAN 850/1000 '17-22



REAR

» 2882023 • \$149⁹⁹
SPORTSMAN XP 1000 S '20-22,
SPORTSMAN 850/1000 '17-22
Fits with Rear Cargo Box (2882882)



ULTIMATE SERIES RACK EXTENDER 7"

FRONT

» 2882024 • \$209⁹⁹
SPORTSMAN XP 1000 S '20-22,
SPORTSMAN 850/1000 '17-22
Not shown



REAR

» 2882025 • \$214⁹⁹
SPORTSMAN XP 1000 S '20-22,
SPORTSMAN 850/1000 '17-22
Does not fit with Rear Cargo Box (2882882)



FRONT RACK EXTENDER

» 2879890 • \$134⁹⁹
SPORTSMAN 850/1000 TOURING '10-22
Does not fit with Front Cargo Box (2877951)

ULTIMATE SERIES STEEL RACK

FRONT

» 2883257 • \$209⁹⁹
SPORTSMAN XP 1000 S '20-22,
SPORTSMAN 850/1000 '17-22



REAR

» 2883258 • \$269⁹⁹
SPORTSMAN XP 1000 S '20-22,
SPORTSMAN 850/1000 '17-22



ULTIMATE SERIES MOVEABLE TIE-DOWN POINTS

» 2882270 • \$74⁹⁹
(FRONT & REAR - SOLD IN PAIRS)
SPORTSMAN 850/1000 '17-22



PROTECTION

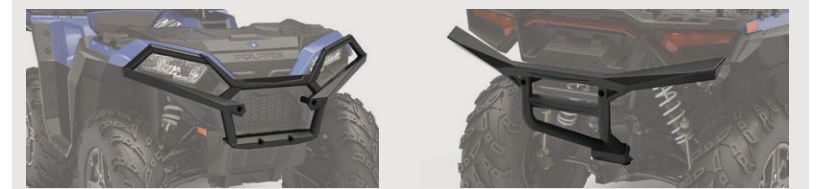

ULTIMATE SERIES BRUSHGUARD

- Quick installation to the integrated mounting tubes on the vehicle using wedge-style expansion anchor mounts
- Attach the Body Armor to the Front Brushguard to provide the ultimate protection for the front fenders

» 2882020 • FRONT • \$339⁹⁹ **TOP SELLER**
SPORTSMAN XP 1000 S '20-22,
SPORTSMAN 850/1000 '17-22

» 2882583 • REAR • \$269⁹⁹ **TOP SELLER**
SPORTSMAN XP 1000 S '20-22,
SPORTSMAN 850/1000 '17-22



ULTIMATE SERIES BODY ARMOR

- Securely mounts to Ultimate Series SPORTSMAN XP Front Brushguard (2882020)
- Comes as pair

» 2882090 • \$414⁹⁹
SPORTSMAN 850/1000 '17-22

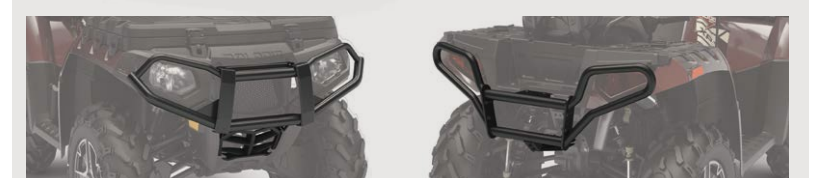

TOURING XP BRUSHGUARD

- Adds heavy-duty protection and a custom look

» 2878709 • FRONT • \$299⁹⁹
SPORTSMAN 850/1000 TOURING '10-22

» 2878324 • REAR • \$219⁹⁹
SPORTSMAN 850/1000 TOURING '10-22

SPORTSMAN 850 XP 1000 XP 1000 S



STORAGE



LOCK & RIDE REAR CARGO BOX

- Increase your storage with an extra 21.25 gallons of dry, dust-proof storage
- Mounts easily with Lock & Ride to the rear rack and is compatible with rack extenders and gun mount
- Includes 2 padlock locations
- Will not fit when Ultimate Series Steel Rack is installed

» 2884853 • \$414⁹⁹

SPORTSMAN XP 1000 S '20-22, SPORTSMAN 850/1000 '17-22



LOCK & RIDE OPEN CARGO BOX

- Increase your storage with an extra 22 gallons of convenient storage space
- Mounts easily with Lock & Ride to the rear rack and is compatible with rack extenders and gun mount
- Holds 2, 5-gallon buckets with integrated grab handle to make it easy to carry and transport cargo
- 12 convenient tie-down locations to secure cargo

• Includes 2 padlock locations

• Will not fit when Ultimate Series Steel Rack is installed

» 2884854 • \$269⁹⁹

SPORTSMAN XP 1000 S '20-22, SPORTSMAN 850/1000 '17-22



LOCK & RIDE REAR COOLER BOX

- Increase your storage with an extra 46 quarts of weather-resistant cooler storage space
- Mounts easily with Lock & Ride to the rear rack and is compatible with rack extenders and gun mount
- Integrated bottle opener and 2 padlock locations
- Will not fit with Ultimate Series Steel Rack

» 2884857 • \$519⁹⁹

SPORTSMAN XP 1000 S '20-22, SPORTSMAN 850/1000 '17-22

NEW POD BAG

- Keep your essentials in reach with 2 Liters of storage capacity
- Mounts to the top of the light pod with HD Velcro®
- Semi-rigid construction and PU Laminated EVA material keeps belongings protected from the elements
- Compatible with windshields

» 2889286 • \$94⁹⁹

SPORTSMAN 850/1000 21-22



ULTIMATE SERIES READY PACK

- Keep your trail essentials at the ready with this easy-to-access, weather-resistant storage compartment

» 2882271 • \$89⁹⁹

SPORTSMAN 850/1000 '17-22



LOCK & RIDE FRONT CARGO BOX

» 2877951 • \$259⁹⁹

SPORTSMAN 850/1000 TOURING '10-22

Front Rack Extender cannot be installed at the same time as the Front Cargo Box



LOCK & RIDE REAR STORAGE BOX

» 2878000 • \$259⁹⁹

SPORTSMAN 850/1000 TOURING '10-22

Slight interference with SPORTSMAN Touring 550/850 '11-14 passenger handles

AUDIO



LOCK & RIDE REAR AUDIO STORAGE BOX

- Dual 6" speakers by Rockford Fosgate® that connect via Bluetooth®
- Mounts easily with Lock & Ride to the rear rack and is compatible with rack extenders and gun mount
- Rest easy knowing that your speakers are protected with a sealed-lid container
- Rear Power Harness (2889071) is required

» 2884856 • \$779⁹⁹

SPORTSMAN XP 1000 S '20-22, SPORTSMAN 850/1000 '17-22



AUDIO STORAGE BOX REMOTE

- Easily control the volume or switch to the next song on your Rear Audio Storage Box
- Conveniently mounts to your ATV's handlebars

» 2884987 • \$129⁹⁹

SPORTSMAN XP 1000 S '20-22, SPORTSMAN 850/1000 '17-22

COMFORT



HANDLEBAR MOUNTED MIRRORS TOP SELLER

- Enhances visibility of what's behind you for added safety
- Sold as a pair
- Does not fit with Windshield Fairing or Handguards

» 2877222 • \$54⁹⁹

SPORTSMAN XP 1000 S '20-22, SPORTSMAN 850/1000 TOURING '10-22, SPORTSMAN 850/1000 '09-22,



HANDGUARDS

<input type="checkbox"/> BRIGHT WHITE	2876883	\$55 ⁹⁹
<input checked="" type="checkbox"/> BLACK <small>TOP SELLER</small>	2876846	\$55 ⁹⁹
<input type="checkbox"/> INDY RED	2876845	\$55 ⁹⁹

- Handguard Mount (2889341) is required when installing Polaris Handguards

• Does not fit with windshield or Handlebar Mounted Mirrors

NEW

» 2889341 • MOUNT • \$43⁹⁹

SPORTSMAN XP 1000 S '20-22, SPORTSMAN 850/1000 TOURING '10-22, SPORTSMAN 850/1000 '09-22,



HAND & THUMB WARMER KIT TOP SELLER

- Provides heat to grips and throttle and is easily installed by plugging into pod
- Includes two heated grips and one throttle warmer

» 2885002 • \$129⁹⁹

SPORTSMAN 850/1000 '21-22



HAND WARMERS TOP SELLER

» 2877363 • \$79⁹⁹

SPORTSMAN XP 1000 S '20, SPORTSMAN XP 1000 '15-20, SPORTSMAN 850 15-20, SPORTSMAN TOURING XP 1000 '15-22, SPORTSMAN TOURING 850 '15-22



THROTTLE/THUMB WARMERS TOP SELLER

» 2877364 • \$64⁹⁹

SPORTSMAN XP 1000 S '20, SPORTSMAN XP 1000 '15-20, SPORTSMAN 850 15-20, SPORTSMAN TOURING XP 1000 '15-22, SPORTSMAN TOURING 850 '15-22



NEW REAR POWER HARNESS

- Provides power to the rear of the ATV for electrical accessories including Rear Audio Storage Box

» 2889071 • \$109⁹⁹

SPORTSMAN XP 1000 S '20-22, SPORTSMAN XP 1000 '17-22, SPORTSMAN 850 '17-22

SPORTSMAN 850 XP 1000 XP 1000 S



DO MORE

WINDSHIELDS

LOCK & RIDE WINDSHIELDS

- Provides enhanced protection from the elements and off-road hazards
- Easily installs and removes without tools utilizing Lock & Ride technology
- Improved mounting system for easier and quicker attachment and detachment

SIZE	COLOR	PART #	PRICE
TALL 18"	CLEAR	2884945	\$234 ⁹⁹
MID 14"	CLEAR	2884845	\$219 ⁹⁹
SHORT 9"	CLEAR	2884946	\$209 ⁹⁹

SPORTSMAN XP 1000 S '21-22, SPORTSMAN XP 1000 '21-22, SPORTSMAN 850 '21-22

SIZE	COLOR	PART #	PRICE
TALL 18"	CLEAR	2889491	\$234 ⁹⁹

SPORTSMAN XP 1000 S '22, SPORTSMAN XP 1000 '22, SPORTSMAN 850 '22 WITH 7" DISPLAY POWERED BY RIDE COMMAND INSTALLED



LOCK & RIDE WINDSHIELDS

- Installs and removes in seconds without tools with Lock & Ride technology
- Poly windshields are flexible, impact-resistant, and provide long-term value over the life of your machine
- Does not work with Handguards

SIZE	COLOR	PART #	PRICE
TALL 48.9 cm	CLEAR	2880539-409	\$219 ⁹⁹
MID 39.4 cm	SMOKE	2880540-412	\$209 ⁹⁹

SPORTSMAN TOURING XP 1000 '15-22, SPORTSMAN TOURING 850 '15-22

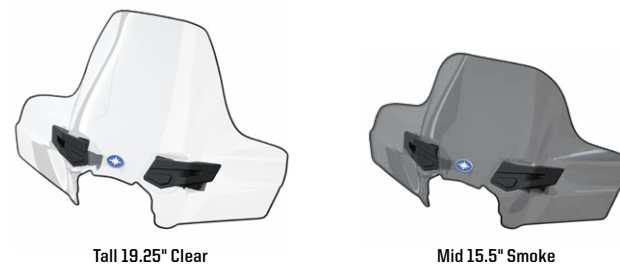

LOCK & RIDE ULTIMATE SERIES WINDSHIELD FAIRING

- Customizable system based on your style and protection needs
- Install the fairing to add one of the Ultimate Series Windshields below
- Does not work with Handguards or Handlebar Mounted Mirrors

» 2882512 • \$209⁹⁹

SPORTSMAN XP 1000 S '20, SPORTSMAN XP 1000 '17-20, SPORTSMAN 850 '17-20



ULTIMATE SERIES WINDSHIELDS

- Fairing required to add your preferred windshield

SIZE	PART #	PRICE
TALL 20"	2882152	\$134 ⁹⁹
MID 16"	2882151	\$124 ⁹⁹

SPORTSMAN XP 1000 S '20, SPORTSMAN XP 1000 '17-20, SPORTSMAN 850 '17-20



EASY TO CHANGE WINDSHIELDS WITH 6-DART INSTALL

Our fairing system allows for changing out the windshield quickly and easily. Simply remove the six dart-type fasteners and swap out the windshield.

PLOWS

P. 38



WHEELS & TIRES

P. 42



LIGHTING

P. 48

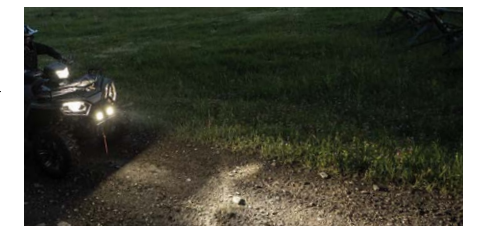

HUNT

P. 50



SCRAMBLER 850 XP 1000 S



WINCHES

POLARIS PRO HD 3,500 LB. WINCH

» 2883580 • \$709⁹⁹
SCRAMBLER XP 1000 S '20-21



NEW
» 2889471 • \$709⁹⁹
SCRAMBLER 850 '14-22,
SCRAMBLER XP 1000 '14-18



NEW POLARIS HD 3,500 LB. WINCH

» 2889470 • \$599⁹⁹
SCRAMBLER 850 '14-22, SCRAMBLER XP 1000 '14-18



NEW POLARIS HD 2,500 LB. WINCH

» 2889469 • \$519⁹⁹
SCRAMBLER 850 '14-22, SCRAMBLER XP 1000 '14-18



RACKS/STORAGE

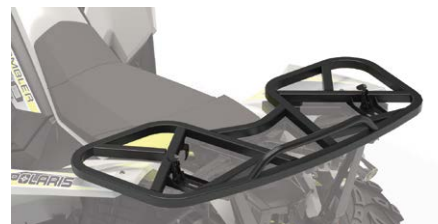

LARGE REAR RACK

» 2879139 • \$219⁹⁹
SCRAMBLER XP 1000 S '20-21, SCRAMBLER XP 1000 '14-18,
SCRAMBLER 850 '14-22
Not compatible with Ogio® Bag (2879925)



OGIO® BAG

» 2879925 • \$229⁹⁹
SCRAMBLER XP 1000 S '20-21, SCRAMBLER XP 1000 '14-18,
SCRAMBLER 850 '14-22

PROTECTION



ULTIMATE SPORT SERIES FRONT BRUSHGUARD

» 2883595 • \$324⁹⁹
SCRAMBLER XP 1000 S '20-21



FRONT BRUSHGUARD

» 2879136 • \$269⁹⁹
SCRAMBLER 850 '14-22, SCRAMBLER XP 1000 '14-18
Replaces existing lower bumper – will not work together

MISCELLANEOUS ACCESSORIES



BOOM SPRAYER

» 2882266 • \$539⁹⁹
ALL SPORTSMAN MODELS EXCEPT TOURING



ATV LICENSE PLATE

• Includes numbers and letters
» 2873270 • \$20⁹⁹



QUICKTAP BATTERY POSTS

- Easy-to-access terminal posts give you quick access to the battery power
- Ideal for charging your battery, powering a temporary accessory, or when you need to offer an unexpected jump-start
- Connection posts feature covers to protect terminals when not in use

» 2882110 • \$74⁹⁹



RIDE & REPAIR ESSENTIALS KIT

- 12-volt DC portable air compressor
- Tire repair kit with 6 plugs
- Basic first-aid kit with bandages, scissors, safety pins, and more
- 12-volt jumper cables
- Duct tape - 300mm x 1 roll
- Zip ties - 150mm length
- Electrical tape
- Ratchet strap - 50mm
- Microfiber cloth
- Carry bag

» 2881207 • \$134⁹⁹

FOR TRAILERING AND RECOVERY STRAPS SEE P. 67

YOUTH ATV OUTLAW 70 EFI

THE PERFECT FIRST ALL-TERRAIN VEHICLE FOR
KIDS STARTING AT 6 YEARS AND OLDER.



FRONT BRUSHGUARD

- Provides enhanced protection from brush and other debris on the trail

» 2884567 • \$159⁹⁹
OUTLAW 70 EFI '21-22



REAR BRUSHGUARD

- Protect the rear of your youth ATV from hazards on the trails

» 2884778 • \$55⁹⁹
OUTLAW 70 EFI '21-22

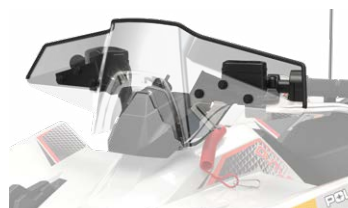

WINDSHIELD - POLY

- Added wind and hand protection with a durable poly design

» 2885005 • \$129⁹⁹
OUTLAW 70 EFI '21-22

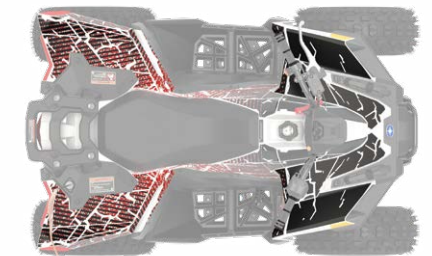

DECAL KIT - INDY RED

- Replaces the stock Outlaw 70 decals to provide a unique and custom look for your youth ATV

» 2885107 • \$119⁹⁹
OUTLAW 70 EFI '21-22

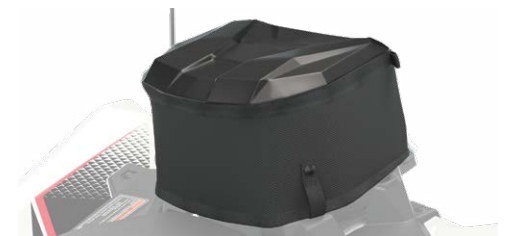

REAR STORAGE BAG

- Convenient storage that easily connects to the rear rack

» 2884555 • \$89⁹⁹
OUTLAW 70 EFI '21-22

ACCESSORIES

WINCHES

450-570

850-XP1000-XP1000S

SCRAMBLER 850-XP1000S

MISC & YOUTH

PLOWS & TRACKS

WHEELS & TIRES

LIGHTING

HUNT & COOLERS



PLow SYSTEM

TAKE COMMAND OF CLEARING SNOW AND MAKE QUICK WORK OF EVEN THE HEAVIEST JOBS.



THE POLARIS ENGINEERED ADVANTAGE

INSTALLATION

30 seconds: Drive up, clip in, lock down, and go – the integrated Polaris Engineered Glacier Plow System simplifies plowing.



CONVENIENCE

Lift and angle adjustments can be made from the driver's seat.

ANGLE YOUR BLADE RIGHT FROM YOUR SEAT WITH THE GLACIER PRO PLOW HYDRAULIC ANGLE SYSTEM

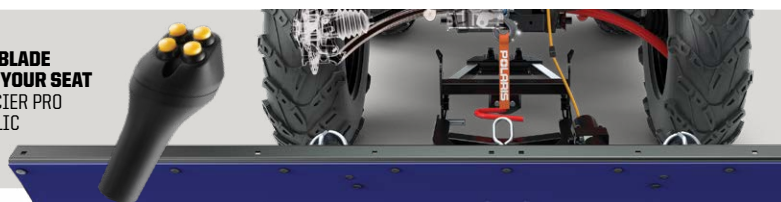

ROBUST FRAME

A plow system is only as strong as its frame, and Polaris Engineered plow frames have a wide frame to withstand the rigors of heavy plowing.



DURABLE BLADES

Available in strong stamped steel or corrosion-resistant poly materials, Polaris Engineered plow blades cover a large surface area for quick snow removal.

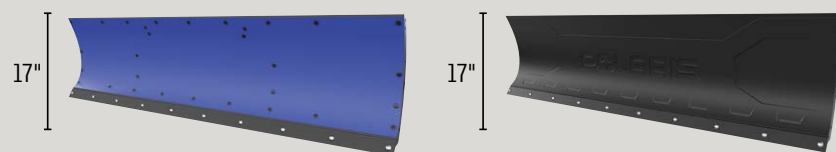

66" POLY BLADE

60" & 52" STEEL BLADE

PLow SYSTEMS (Winch required, sold separately)

Choose a Glacier Plow System, designed to help you get the most out of your SPORTSMAN during snowy months. Select a system based on your plowing needs with premium add-ons including a hydraulic lift system or additional plow accessories.

NEW GLACIER PRO HD PLOW SYSTEM WITH HYDRAULICS

- Mount (2881424)
- Frame (2879630)
- 66" Poly Plow (2880269)
- Hydraulic Angle (2879635)
- Hydraulic Controller (2880836)
- Plow Markers (2872726)
- Plow Deflector (2879866)

» 3880010 • \$2,129⁹⁹
450 '15-22, 570 '15-22, 6X6 570 '17-22, X2 570 '15-21, 570 TOURING '15-22
REQUIRES LIFT METHOD: SEE WINCHES BELOW

NEW GLACIER PRO HD PLOW SYSTEM

- Mount (2881424)
- Frame (2879630)
- 60" Steel Plow (2879638)

» 3880011 • \$902⁹⁹
450 '15-22, 570 '15-22, 6X6 570 '17-22, X2 570 '15-21, 570 TOURING '15-22
REQUIRES LIFT METHOD: SEE WINCHES BELOW

NEW GLACIER PRO HD PLOW SYSTEM WITH HYDRAULICS

- Mount (2881423)
- Frame (2879630)
- 66" Poly Plow (2880269)
- Hydraulic Angle (2879635)
- Hydraulic Controller (2880836)
- Plow Markers (2872726)
- Plow Deflector (2879866)

» 3880012 • \$2,129⁹⁹
XP 1000 '15-22, 850 '15-22, TOURING 1000 '15-22, TOURING 850 '15-22, SCRAMBLER 850 '15-22
REQUIRES LIFT METHOD: SEE WINCHES BELOW

NEW GLACIER PRO HD PLOW SYSTEM

- Mount (2881423)
- Frame (2879630)
- 60" Steel Plow (2879638)

» 3880013 • \$902⁹⁹
XP 1000 '15-22, 850 '15-22, TOURING 1000 '15-22, TOURING 850 '15-22, SCRAMBLER 850 '15-22
REQUIRES LIFT METHOD: SEE WINCHES BELOW

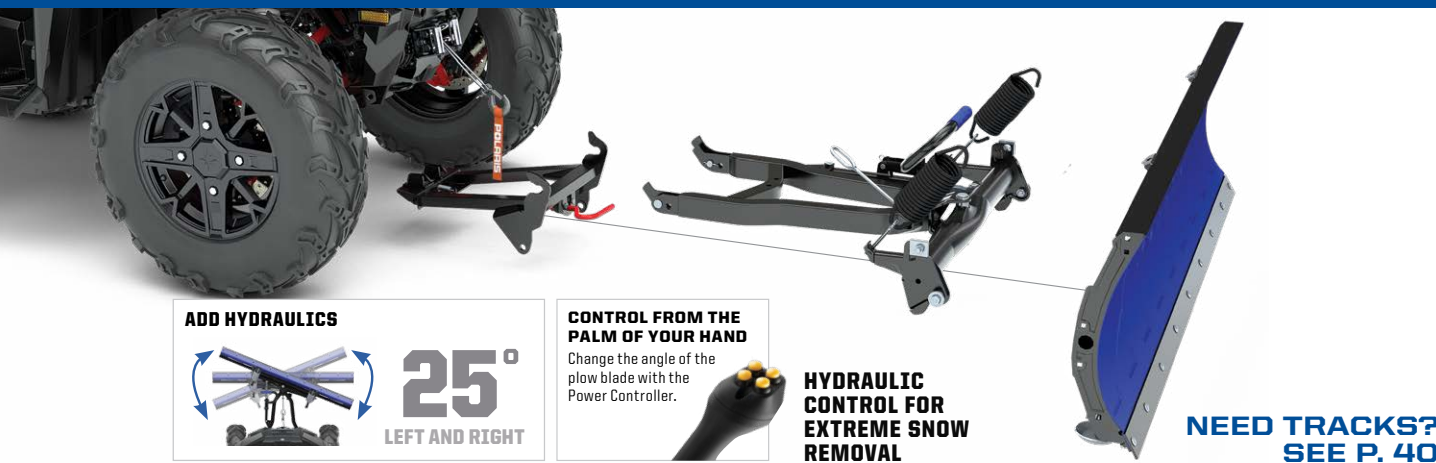

GLACIER PRO HD GIVES YOU:

» 66", 60" or 52" Blades

» Choice of poly or steel

» Ability to add a hydraulic angle system

MODELS	MANDATORY STEPS				OPTIONAL
	STEP 1 SELECT A MOUNT	STEP 2 SELECT A FRAME	STEP 3 SELECT PLOW CONFIGURATION	BLADES	STEP 4 ADD HYDRAULICS
XP 1000 '15-22 850 '15-22 850/XP 1000 HIGHLIFTER '16-22 TOURING XP 1000 '15-22 TOURING 850 '10-22 SCRAMBLER 850 '14-22	MOUNT TOP SELLER 2881423 \$229 ⁹⁹	FRAME TOP SELLER 2879630 \$339 ⁹⁹	WINCHES NEW Polaris Pro HD 3,500 lb. Winch 2889471 \$709 ⁹⁹ NEW Polaris HD 3,500 lb. Winch 2889470 \$599 ⁹⁹ NEW Polaris HD 2,500 lb. Winch 2889469 \$519 ⁹⁹	BLADES 66" Poly 2880269 \$539 ⁹⁹ TOP SELLER 60" Steel 2879638 \$339 ⁹⁹ TOP SELLER 52" Steel 2879639 \$279 ⁹⁹	HYDRAULICS Hydraulic Plow Blade Angle System 2879635 \$739 ⁹⁹ Power Controller 2880836 \$134 ⁹⁹ Power Controller Recommended
XP 1000 S '20-22 SCRAMBLER XP 1000 S '20-21	2883581 \$234 ⁹⁹		Polaris Pro HD 3,500 lb. Winch 2883580 \$709 ⁹⁹		
570 '15-20 6X6 570 '17-22 X2 570 '15-21 TOURING 570 '14-22 450 H.O. '12-20	TOP SELLER 2881424 \$229 ⁹⁹		Polaris HD 3,500 lb. Winch 2880434 \$609 ⁹⁹ Polaris HD 2,500 lb. Winch 2880432 \$509 ⁹⁹		
570 '21-22 450 H.O. '21-22			Polaris Pro HD 3,500 lb. Winch 2884834 \$709 ⁹⁹ Polaris HD 3,500 lb. Winch 2884833 \$599 ⁹⁹ Polaris HD 2,500 lb. Winch 2884832 \$519 ⁹⁹		

STEP 5 SELECT ACCESSORIES AND REPLACEMENT ITEMS

- 66" HD Wear Bar 2879868 | \$134⁹⁹
- 66" Plow Blade Snow Deflector 2879866 | \$114⁹⁹
- 66" Wear Bar 2879867 | \$74⁹⁹
- 60" Plow Blade Deflector 2871808 | \$89⁹⁹
- 60" Wear Bar 2877243 | \$48⁹⁹
- Skid Shoe 2205071 | \$36⁹⁹
- 52" Wear Bar 2877210 | \$54⁹⁹
- Glacier Pro Shear Pin Replacement 2205063 | \$17⁹⁹
- Plow Winch Rope For 2,500 lb. & 3,500 lb. winches | 2878483 | \$38⁹⁹
- Glacier Plow Marker Sold in pairs | 2872726 | \$43⁹⁹
- Rear Tire Chains Recommended for rear tires only | 2881422 | \$129⁹⁹
- Plow Blade Track Extension Required for track equipped vehicles | 2879719 | \$249⁹⁹

ALL-TERRAIN TRACTION

It's tough to make SPORTSMAN even more versatile than it already is. But with a set of Prospector Pro[®] Tracks, you'll do just that. Tread through deep snow without concern.

Polaris-specific gearing provides 1:1 ratio to:

- Minimize track slip, providing better climbing ability and improved traction in deep snow
- Improve top speed over prior models by approximately 5%
- Reduce operating RPM for a quieter ride
- Improve driveline durability, which allows vehicle to run at a lower RPM, decreasing engine wear

Polaris exclusive optimized hub geometry that minimizes feedback and eases steering effort

Lightweight design provides for better flotation, eases steering effort, and provides better vehicle control

Flexible lug design provides the highest level of deep snow performance by lifting up in deep snow as opposed to digging down

New front dual stabilizer for improved stability

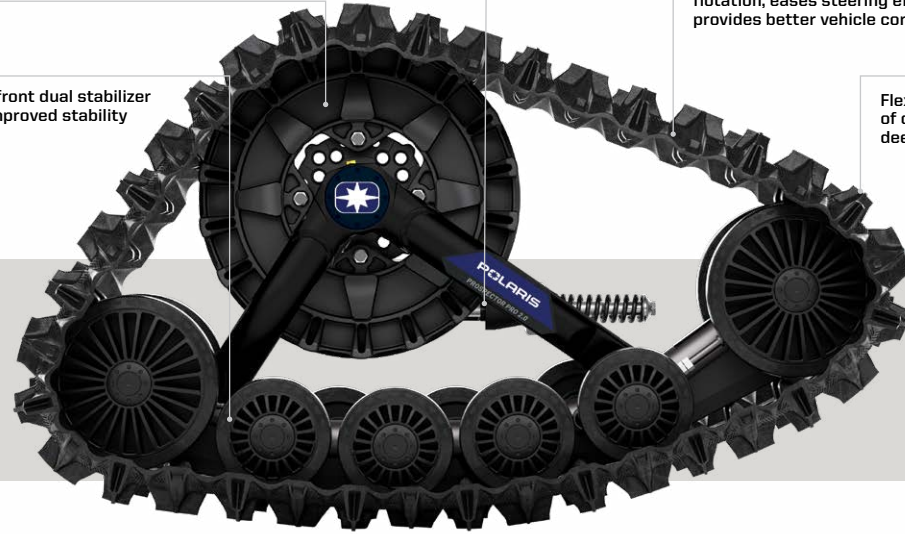

PROSPECTOR PRO 2.0 TRACK SYSTEM

STEP 1: SELECT A MOUNT KIT		
MODELS	A-ARMS	MOUNT KIT
SPORTSMAN XP 1000/850 (15-22) SPORTSMAN TOURING XP 1000/850 (15-22)	STRAIGHT	2879457 \$569 ⁹⁹
SPORTSMAN XP 1000/850 (16-22) HIGHLIFTER 1000/850 (16-22)	ARCHED	2882109 \$569 ⁹⁹
SPORTSMAN XP 1000 S (20-22) SCRAMBLER XP 1000 S (20-21)	ARCHED	2883977 \$569 ⁹⁹
SPORTSMAN 570 (21-22)	ARCHED	2889218 \$569 ⁹⁹
SPORTSMAN 570 (21-22)	STRAIGHT	2889219 \$569 ⁹⁹
SPORTSMAN 570 (15-22) SPORTSMAN TOURING 570 (15-22) SPORTSMAN X2 570 (15-21)	STRAIGHT	2879497 \$569 ⁹⁹

STEP 2: SELECT A TRACK KIT		
MODELS	EPS	TRACK KIT
SPORTSMAN 570 (15-22) SPORTSMAN TOURING 570 (15-22) SPORTSMAN X2 570 (15-21)	YES	2889493 \$5,549 ⁹⁹
SPORTSMAN XP 1000/850 (15-22) SPORTSMAN TOURING XP 1000/850 (17-22) HIGHLIFTER 1000 (16-22) SPORTSMAN XP 1000 S (20-22) SCRAMBLER XP 1000 S (20-21)	YES	2889495 \$5,549 ⁹⁹
SPORTSMAN 570 (14-22) SPORTSMAN TOURING 570 (15-22)	NO	2889492 \$5,549 ⁹⁹
SPORTSMAN XP 1000 (18-22) SPORTSMAN 850 (15-22) SCRAMBLER 850 (13-22)	NO	2889494 \$5,549 ⁹⁹

TRACK AND MOUNT KIT		
MODELS	EPS	TRACK AND MOUNT KIT
SPORTSMAN 570 6X6 (17-22)	YES	2882169 \$7,739 ⁹⁹

WANT TO PLOW?

GLACIER PRO PLOW TRACK EXTENSION







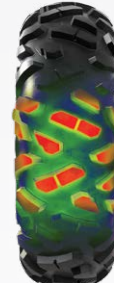

- Plow extension for use when using the Prospector Pro[®] Track System and Glacier Pro SPORTSMAN plow system

» 2879719 • \$249⁹⁹

FOR USE WITH GLACIER PRO PLOW SYSTEMS

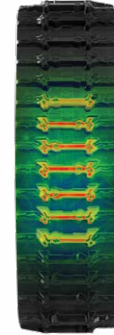

SPORTSMAN SNOW TRACTION OPTIONS

TREAD THROUGH SNOW WITH THESE OPTIONS	CONTACT PATCH	TURNING RADIUS
 <p>STOCK TIRES</p>	<p>GOOD</p> 	<p>139.5"</p> 
 <p>PRO ARMOR WHITEOUT</p>	<p>BETTER</p>  <p>MORE SURFACE AREA FOR BETTER FLOTATION ON SNOW</p>	<p>138.875"</p> 
 <p>NEW PROSPECTOR PRO[®] 2.0 TRACKS</p>	<p>BEST</p>  <p>LESS AGGRESSIVE TREAD DISPLACES SNOW FOR BETTER HANDLING</p>	<p>175.375"</p> 

COMMON

WINCHES

450-570

850-XP1000-XP1000S

SCRAMBLER 850-XP1000S

MISC & YOUTH

PLOW & TRACKS

WHEELS & TIRES

LIGHTING

HUNT & COOLERS

KNOW YOUR TERRAIN



- Tread patterns optimized for extreme traction
- Ideal for both hard pack and loose trail



- Flexible "grippy" tread
- Aggressive side bite



- Provides traction and durability
- Built to perform in hard sand, jagged rocks or any other extreme terrain



- Extra deep treads
- Self-cleaning lugs



- Paddles provide traction and durability in soft sand
- Built to float on top of sand



- Triple-belted sidewalls to resist puncture
- Purpose-built, long lasting tread patterns



- Handles extreme cold
- Holds shape and provides traction

SUPERIOR PERFORMANCE & DURABILITY

WAYS TO SHOP WHEELS & TIRES



LIFELONG PERFORMANCE

- Every tire is designed and constructed with longevity in mind
- 3,000+ mile rated (4,828 kilometers)

PREMIUM PROTECTION

- Pro Armor makes tires with extra protection exactly where it's needed most – the sidewall
- Triple-belted sidewalls keep your tires more resistant so you can keep going

TOUGH TIRES

- Higher ply ratings mean added protection
- Pro Armor builds 8 or 10-ply rated tires for higher puncture-resistance

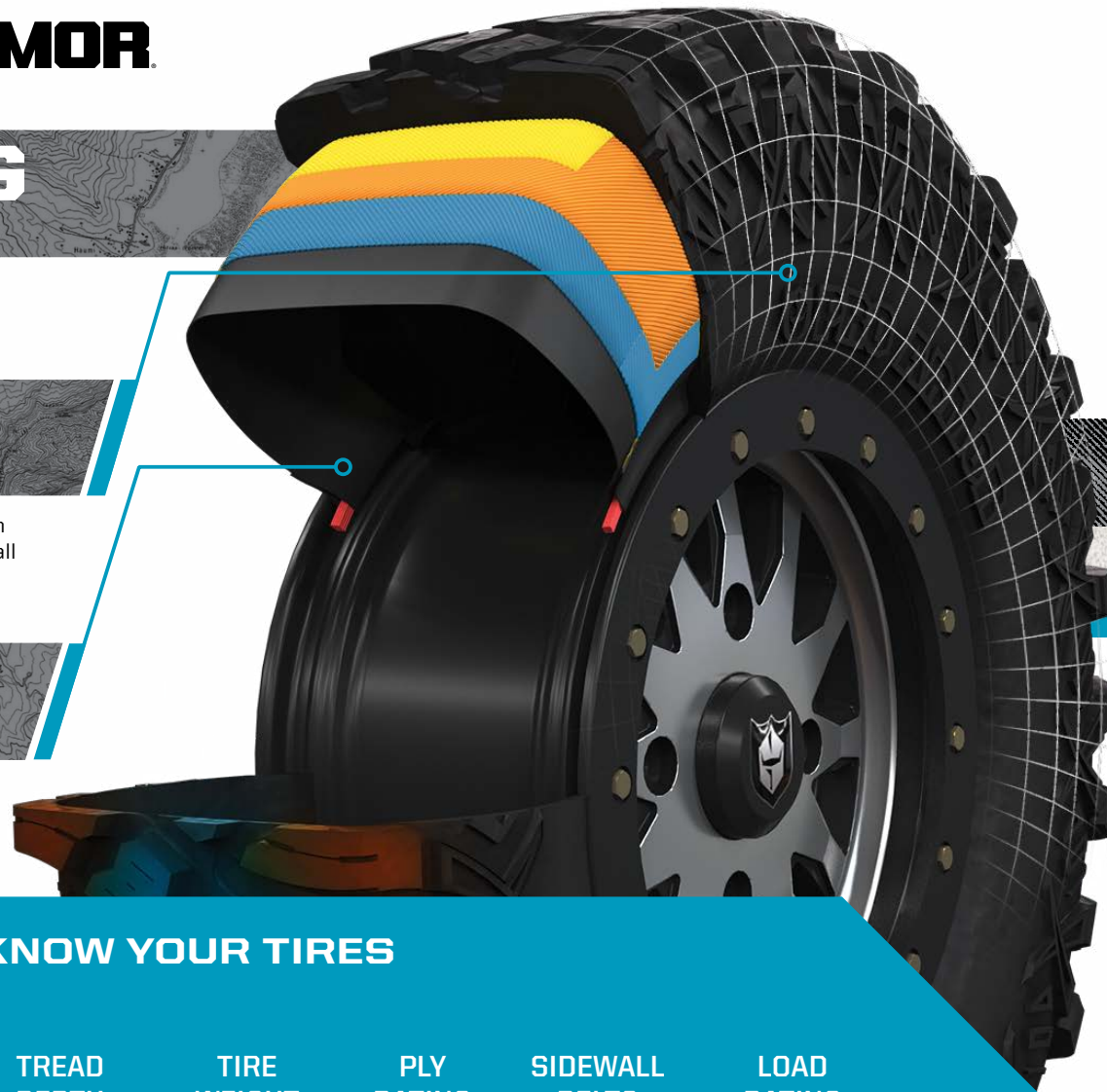

KNOW YOUR TIRES

DIMENSIONS			TREAD DEPTH	TIRE WEIGHT	PLY RATING	SIDEWALL BELTS	LOAD RATING
TIRE HEIGHT	TIRE WIDTH	WHEEL DIAMETER					
32" x 9" R15	FRONT/REAR	30mm	41 LBS	10	3	1,320 LBS	
Part Number • Price							

USAGE
Where can you use the tire

TREAD DEPTH
Deeper treads have more grip in all conditions

TIRE WEIGHT
A lighter tire makes for improved vehicle performance

PLY RATING
Indicates tire puncture-resistance

SIDEWALL BELTS
Increase your resistance to sidewall punctures

LOAD RATING
How much weight can the tire handle

TIRES BY SIZE

26"	27"
ATTACK	MUD XC
DUAL-THREAT	PRESERVE
HARVESTER	HARVESTER
PRESERVE	WHITEOUT
XD-K	

TIRES BY TERRAIN

TRAIL	ROCK	DESERT	MUD	UTILITY	SNOW
DUAL-THREAT	DUAL-THREAT	DUAL-THREAT	MUD XC	ATTACK	ATTACK
ATTACK	ATTACK	ATTACK		HARVESTER	HARVESTER
HARVESTER				PRESERVE	PRESERVE
PRESERVE				XD-K	XD-K
XD-K					WHITEOUT
MUD XC					

TIRES



PRO ARMOR DUAL-THREAT

- Dual-compound technology and radial construction offer performance in all terrains
- Softer durometer rubber on outer edge for overall superior grip and feel
- Harder durometer rubber in the middle for increase traction during acceleration and longer tread life

	TREAD DEPTH	TIRE WEIGHT	PLY RATING	SIDEWALL BELTS	LOAD RATING
14" 26" x 9" R14 5416340 • *219 99	16 mm	27 lbs	10	3	910 lbs
14" 26" x 11" R14 5416341 • *229 99		30 lbs			1,100 lbs



PRO ARMOR ATTACK

- The best all-purpose tire for all-season traction in any terrain
- Unique full-face tread design
- Harder durometer lugs promote extended wear, increasing tire life

	TREAD DEPTH	TIRE WEIGHT	PLY RATING	SIDEWALL BELTS	LOAD RATING
14" 26" x 9" R14 5415613 • *189 99	23 mm	28 lbs	8	3	910 lbs
14" 26" x 11" R14 5415614 • *209 99		32 lbs			1,320 lbs



COMMON

WINCHES

450-570

850-XP1000-XP1000S

SCRAMBLER 850-XP1000S

MISC & YOUTH

PLOWS & TRACKS

WHEELS & TIRES

LIGHTING

HUNT & COOLERS

43

TIRES



PRO ARMOR HARVESTER

- All-around workhorse with tread life of 5,000 miles / 8,047 kilometers
- Tread pattern designed to withstand anything from the farmyard to the pastures to the trail
- With 10-ply, it can carry the load day-in and day-out

	TREAD DEPTH	TIRE WEIGHT	PLY RATING	SIDEWALL BELTS	LOAD RATING	
12" 26" x 8" R12 5416396 • \$229 ⁹⁹	FRONT	24 lbs			855 lbs	
12" 26" x 10" R12 5415966 • \$249 ⁹⁹	REAR	16 mm	32 lbs	10	3	1,320 lbs
14" 27" x 10" R14 5415965 • \$249 ⁹⁹	FRONT/REAR		32 lbs		1,320 lbs	



PRO ARMOR WHITEOUT

- Extra wide tires for flotation in snow
- Tread pattern designed for superior snow traction with limited digging

	TREAD DEPTH	TIRE WEIGHT	PLY RATING	SIDEWALL BELTS	LOAD RATING	
14" 27" x 14" R14 5416032 • \$369 ⁹⁹	FRONT/REAR	16 mm	24 lbs	8	3	935 lbs



PRO ARMOR PRESERVE

- Turf-friendly for areas where low impact from tire tread is needed
- Exceptionally quiet-running and low impact

	TREAD DEPTH	TIRE WEIGHT	PLY RATING	SIDEWALL BELTS	LOAD RATING	
12" 26" x 8" R12 5416403 • \$229 ⁹⁹	FRONT	29 lbs			1,320 lbs	
12" 26" x 10" R12 5416402 • \$249 ⁹⁹	REAR	16 mm	28 lbs	10	3	1,320 lbs
14" 27" x 10" R14 5416348 • \$249 ⁹⁹	FRONT/REAR		24 lbs		855 lbs	

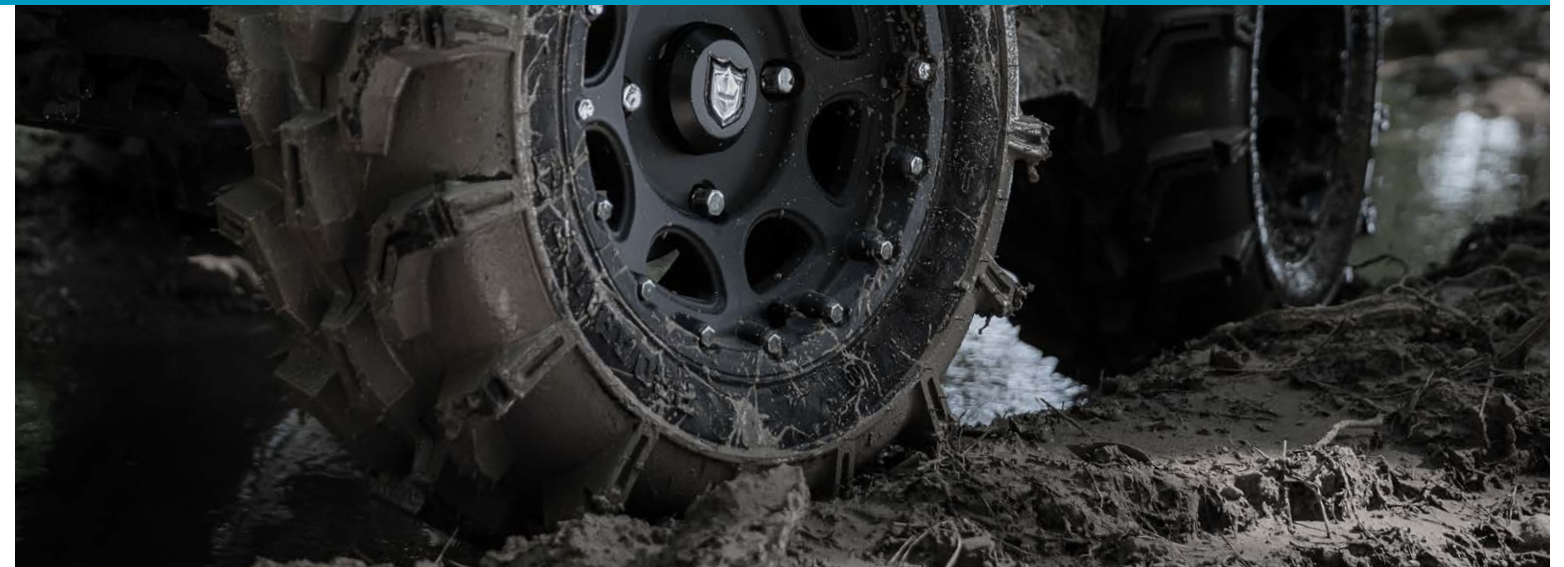

PRO ARMOR XD-K

- 26" Aramid fiber-belted tire can tackle any terrain
- Unique full-face tread design
- Harder durometer lugs promote extended wear, increasing tire life

	TREAD DEPTH	TIRE WEIGHT	PLY RATING	SIDEWALL BELTS	LOAD RATING	
12" 26" x 9" R12 5415756 • \$278 ⁹⁹	FRONT	28 lbs			935 lbs	
12" 26" x 11" R12 5415757 • \$293 ⁹⁹	REAR	31.7 mm	32 lbs	8	3/1 Aramid	1,330 lbs



PRO ARMOR MUD XC

- Designed as the perfect mud-trail crossover for a smooth ride on the trail and aggressive traction in the mud
- Dual-compound technology with harder durometer lugs promotes extended wear, increasing tire life
- 10-ply construction means added protection in the toughest terrain

	TREAD DEPTH	TIRE WEIGHT	PLY RATING	SIDEWALL BELTS	LOAD RATING	
14" 27" x 9" R14 5416947 • \$249 ⁹⁹	FRONT	30 lbs			1,170 lbs	
14" 27" x 11" R14 5416948 • \$259 ⁹⁹	REAR	30 mm	32 lbs	10	3	1,320 lbs



WHEELS



A 4101 ○	E 4201 ○	C 4202 ○
WEIGHT: 14.5 lbs LOAD RATING: 800 lbs OFFSET: -35	FRONT WEIGHT: 13 lbs LOAD RATING: 900 lbs OFFSET: +4	FRONT WEIGHT: 12.75 lbs LOAD RATING: 900 lbs OFFSET: +4
MATTE BLACK: FRONT/REAR 14" × 10" 1522958 \$229 ⁹⁹	REAR WEIGHT: 14 lbs LOAD RATING: 1300 lbs OFFSET: -9	REAR WEIGHT: 13.5 lbs LOAD RATING: 1300 lbs OFFSET: -9
	ACCENT: FRONT 14" × 7" 1522956-266 \$189 ⁹⁹	ACCENT: FRONT 14" × 7" 1522544-266 \$189 ⁹⁹
	REAR 14" × 8" 1522957-266 \$209 ⁹⁹	REAR 14" × 8" 1522545-266 \$209 ⁹⁹
	MATTE BLACK: FRONT 14" × 7" 1522956-458 \$169 ⁹⁹	MATTE BLACK: FRONT 14" × 7" 1522544-458 \$169 ⁹⁹
	REAR 14" × 8" 1522957-458 \$179 ⁹⁹	REAR 14" × 8" 1522545-458 \$179 ⁹⁹
D 4203 BEADLOCK ○	E 4204 ○	F 4205 ○
FRONT WEIGHT: 13 lbs LOAD RATING: 900 lbs OFFSET: +4	FRONT WEIGHT: 13 lbs LOAD RATING: 900 lbs OFFSET: +4	FRONT WEIGHT: 10.5 lbs LOAD RATING: 900 lbs OFFSET: +4
REAR WEIGHT: 14.5 lbs LOAD RATING: 1300 lbs OFFSET: -9	REAR WEIGHT: 14 lbs LOAD RATING: 1300 lbs OFFSET: -9	REAR WEIGHT: 12.5 lbs LOAD RATING: 1300 lbs OFFSET: -9
MATTE BLACK: FRONT 14" × 7" 1522238-458 \$279 ⁹⁹	ACCENT: FRONT 14" × 7" 1522546-266 \$189 ⁹⁹	MATTE BLACK: FRONT 14" × 7" 1521507-521 \$149 ⁹⁹
REAR 14" × 8" 1522239-458 \$279 ⁹⁹	REAR 14" × 8" 1522547-266 \$189 ⁹⁹	REAR 14" × 8" 1521508-521 \$169 ⁹⁹
	MATTE BLACK: FRONT 14" × 7" 1522546-458 \$169 ⁹⁹	LUSTER: FRONT 14" × 7" 1521507-410 \$189 ⁹⁹
	REAR 14" × 8" 1522547-458 \$169 ⁹⁹	REAR 14" × 8" 1521508-410 \$199 ⁹⁹
G 4206 ○	H 4301 BEADLOCK	I HD DUAL BEADLOCK ○
FRONT WEIGHT: 9.5 lbs LOAD RATING: 900 lbs OFFSET: +4	WEIGHT: 16 lbs LOAD RATING: 1600 lbs OFFSET: +38	WEIGHT: 40 lbs LOAD RATING: 1,600 lbs OFFSET: +38
REAR WEIGHT: 10.75 lbs LOAD RATING: 1300 lbs OFFSET: -9		
MATTE BLACK: FRONT 14" × 6" 1522542-458 \$169 ⁹⁹	ACCENT: FRONT/REAR 14" × 7" 1523284 \$269 ⁹⁹	MATTE BLACK: FRONT/REAR 14" × 7" 1524022-458 \$359 ⁹⁹
REAR 14" × 8" 1522543-458 \$179 ⁹⁹	MATTE BLACK: FRONT/REAR 14" × 7" 1523283 \$259 ⁹⁹	

KNOW YOUR WHEELS

STEP 1: SELECT SERIES

4 = 40-SERIES

STEP 2: CHOOSE LOAD RATING

1 = <800 LBS

2 = 801 - 1,300 LBS

3 = 1,301 - 1,600+ LBS

STEP 3: PICK STYLE

OFFSET / BEADLOCK / COLOR

INCREASE OFFSET FROM STOCK = NARROWER STANCE

DECREASE OFFSET FROM STOCK = WIDER STANCE

2 WAYS TO PURCHASE

INDIVIDUAL WHEELS & TIRES
- OR -
COMPLETE SETS AS LISTED

VISIT Polaris.com/ProArmorSPORTSMAN TO BUILD YOUR CUSTOM SET & VERIFY FITMENT

Exclusively at Polaris Authorized Dealers or Polaris.com/ProArmorSPORTSMAN

14" FORGED BEADLOCK RINGS

Sold Individually

	PART #	PRICE
A Machined Only used on 4203 Beadlock & HD Dual Beadlock	1522244-266	\$114 ⁹⁹
B Beadlock Ring - Matte Black - 14" Only used on 4301 Beadlock & HD Dual Beadlock	1523146-458	\$74 ⁹⁹

KNOW YOUR TERRAIN



- Tread patterns optimized for extreme traction
- Ideal for both hard pack and loose trail



- Extra deep treads
- Self-cleaning lugs



- Triple-belted sidewalls to resist puncture
- Purpose-built, long lasting tread patterns



- Handles extreme cold
- Holds shape and provides traction

WHEEL & TIRE SETS

14" ↑ ↓	TRAIL	MUD	UTILITY	SNOW		
40-SERIES	ATTACK 26"	DUAL-THREAT 26"	MUD XC 27"	PRESERVE 27"	HARVESTER 27"	WHITEOUT 27"
4101 Matte Black						2882382 \$2,399 ⁹⁹
4201 Accent	2882390 \$1,489 ⁹⁹	2883138 \$1,669 ⁹⁹	2884272 \$1,739 ⁹⁹	2883208 \$1,599 ⁹⁹	2882388 \$1,739 ⁹⁹	
4201 Matte Black	2882391 \$1,359 ⁹⁹	2883139 \$1,539 ⁹⁹	2884273 \$1,612 ⁴⁹	2883209 \$1,599 ⁹⁹	2882389 \$1,599 ⁹⁹	
4202 Accent	2881335 \$1,599 ⁹⁹	2883140 \$1,699 ⁹⁹	2884267 \$1,739 ⁹⁹	2883203 \$1,739 ⁹⁹	2882383 \$1,739 ⁹⁹	
4202 Matte Black	2881336 \$1,479 ⁹⁹	2883141 \$1,539 ⁹⁹	2884268 \$1,612 ⁴⁹	2883204 \$1,599 ⁹⁹	2882384 \$1,599 ⁹⁹	
4203 BEADLOCK Matte Black	2881381 \$1,669 ⁹⁹					
BEADLOCKS SOLD SEPARATELY						
4204 Accent	2881347 \$1,599 ⁹⁹	2883142 \$1,699 ⁹⁹	2884270 \$1,739 ⁹⁹	2883205 \$1,739 ⁹⁹	2882385 \$1,739 ⁹⁹	
4204 Matte Black	2881348 \$1,479 ⁹⁹	2883143 \$1,539 ⁹⁹	2884271 \$1,612 ⁴⁹		2882386 \$1,599 ⁹⁹	
4205 Luster	2881359 \$1,599 ⁹⁹	2883144 \$1,539 ⁹⁹				
4205 Matte Black	2881360 \$1,479 ⁹⁹	2883145 \$1,539 ⁹⁹	2884269 \$1,599 ⁹⁹	2883207 \$1,599 ⁹⁹	2882387 \$1,599 ⁹⁹	
4206 Matte Black	2881404 \$1,479 ⁹⁹					
4301 BEADLOCK Accent		2883217 \$2,059 ⁹⁹				
BEADLOCKS PRE-MOUNTED						
4301 BEADLOCK Matte Black		2883216 \$1,939 ⁹⁹				
BEADLOCKS PRE-MOUNTED						

LUG NUTS

○ LUG NUTS REQUIRED



METRIC LUG NUTS FOR ALUMINUM RIMS

» 2877385 · SET OF 4 · \$18⁹⁹

» 2877384 · SET OF 16 · \$43⁹⁹ SPORTSMAN XP

SAE LUG NUTS FOR ALUMINUM RIMS

» 2876754 · SET OF 4 · \$18⁹⁹

» 2877409 · SET OF 16 · \$43⁹⁹ SPORTSMAN 450/570

REPLACEMENT CAPS

CENTER CAP		
LUSTER	ALL WHEELS EXCEPT 4204 & 4203 BEADLOCK	1521509-410 \$15 ⁹⁹
MATTE BLACK		1521509-521 \$15 ⁹⁹
HD MATTE BLACK	ALL WHEELS	5457498-458 \$29 ⁹⁹
PRO ARMOR CENTER CAP		
LUSTER	ALL WHEELS EXCEPT 4204 & 4203 BEADLOCK	5453209-410 \$15 ⁹⁹
MATTE BLACK		5453209-458 \$15 ⁹⁹



TIRE SEALANT P. 66

- » 32 OZ. · 2830484 · \$25⁹⁹
- » 1 GALLON · 2830485 · \$89⁹⁹
- » 5 GALLONS · 2830486 · \$364⁹⁹
- » 5 GALLONS, PUMP · 2830487 · \$163⁴⁹

COLBY VALVE SHORT ULTIMATE VALVE - 2 PACK

» 2883292 · \$34⁹⁹

COLBY VALVE EMERGENCY VALVE - 2 PACK

» 2883293 · \$34⁹⁹

COLBY COMBO VALVE KIT - 16 PACK

- Includes eight Ultimate Valves and eight Emergency Valves
- » 2883294 · \$599⁹⁹



POLARIS ENGINEERED ADVANTAGES

MOUNTS PERFECTLY
Designed for your Polaris Engineered bumper, roof or other mounting point

MAX PERFORMANCE
Validated to work as hard as your machine does

DOESN'T OVERTAX
Trust it to work when you need it to

PRO ARMOR



ADVANCED TECH

RIGID® lights are driven by Aluminum PCB Smart Boards®, 6063-T5 aircraft aluminum extruded housings and Tiger Drylac® UV protection polyester powdercoating.

EXCLUSIVE OPTICS

RIGID® lights feature impact-resistant polycarbonate lenses for a 100% water/dustproof seal.

RIGID® LIMITED LIFETIME WARRANTY

If you own a RIGID® light and it breaks, we will replace or repair it for life.*

RUGGED CONSTRUCTION

Pro Armor lights are designed to be big and beefy with an aggressive style all their own, and housed in IP67 marine-grade rated UV polyester powdercoating.

MASSIVELY BRIGHT

Pro Armor builds bright lights designed for any riding experience. All that power is directed through heat dissipating aluminum for streamlined heat management.

LIGHT BAR TYPES



SR-SERIES PRO

Sleek, powerful, low-profile (under 2" tall). Lights extreme distances with low energy usage.
Available in 10"



D-SERIES PRO

Compact to fit almost anywhere with high output and low energy usage.
Available in Driving, Flood & Spot



DUAL-ROW LED LIGHT BARS

The most spread and farthest illumination downrange. Easy to mount.
Available in Cube, 10" & 20"



SINGLE-ROW LED LIGHT BARS

Powerful, compact, low-profile light bars with a sleek look.
Available in 11" & 20"



CUBE LED LIGHTS

Small size allows mounting in strategic locations for added lighting.
Available in Flood & Spot

LIGHT BAR OPTIONS

SHOP & VERIFY VEHICLE FITMENT AT POLARIS.COM/ShopSPORTSMAN

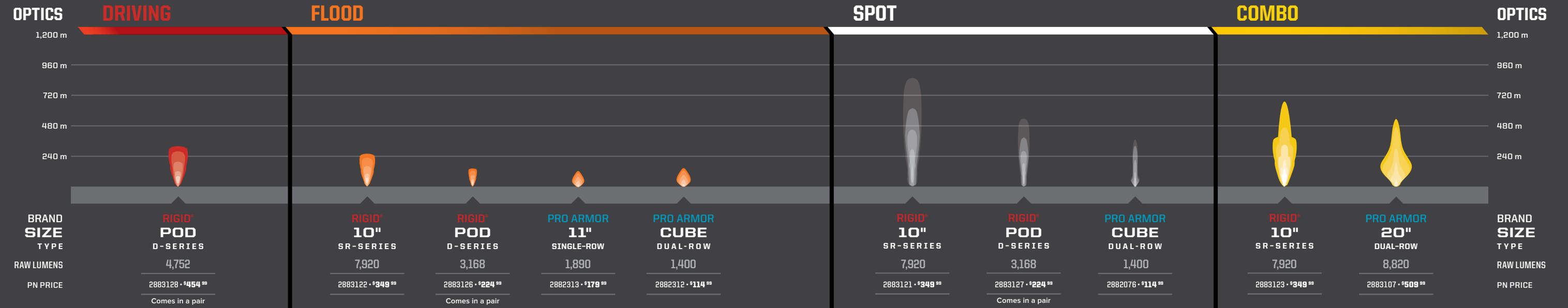

BUILD YOUR VISION

Consider the optics, angle and how you will use your vehicle to choose the right light or set of lights.

OPTICS LIGHT ANGLE	ACCENT	DRIVING (45°)	FLOOD (25°)	SPOT (10°)	COMBO (25°/10°)
DRIVING SPEED	All	Slow	Medium	Fast	Medium to fast
BEAM	Diffused glow	Extra-wide	Wide/Shorter	Concentrated/Long	Inner spot & outer flood
RECOMMENDED MOUNTING	Low/Wheel well	All points	Low &/or rear	High points	All points
TERRAIN & RIDING STYLE	Added style & personalization in any terrain	All riding & utility	Wide-open terrain or trails & utility	Trail & tight conditions	All riding & utility

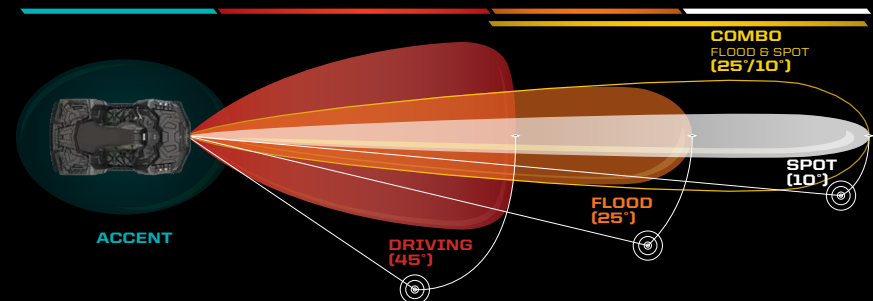

POLARIS ENGINEERED



LED LIGHTING

LED LIGHT KIT

Upgrade your standard headlights and pod lights to LEDs with this upgrade kit

» 2884859 • \$519⁹⁹
SPORTSMAN XP 1000 S '21-22,
SPORTSMAN 850/1000 '21-22,
SPORTSMAN 450/570 '21-22

WIRING HARNESSES

LIGHTBAR HARNESS

Control one light with one switch

» 2882320 • \$74⁹⁹
ALL SPORTSMAN MODELS

LED Y-HARNESS

Requires 2882320 to control two cubes or two lights with one switch

» 2879860 • \$23⁹⁹
ALL SPORTSMAN MODELS

* If RIGID® determines, in its sole discretion, that your product is defective in material or workmanship, RIGID® will honor your warranty claim. In some cases the product will be replaced, depending on the specific time frame of the purchase. If the product is repaired, all parts, labor, and return shipping may be covered by RIGID®.

COMMON

WINCHES

450-570

850-XP1000-XP1000S

SCRAMBLER 850-XP1000S

MISC & YOUTH

PLOWS & TRACKS

WHEELS & TIRES

LIGHTING

HUNT & COOLERS

PROTECTING YOUR ESSENTIAL GEAR SINCE 1943

KOLPIN STRONGHOLD SYSTEM

Polaris is proud to partner with Kolpin Outdoors, an industry leader in off-road accessories and the premier name in gun boots and mounts. If you need to secure a firearm while riding, simply attach the auto-latch mount and choose your Gun Boot.

IDEAL FOR SECURE TRANSPORT OF SCOPED RIFLES AND SHOTGUNS

STEP 1 CHOOSE YOUR MOUNT



STRONGHOLD AUTO-LATCH MOUNT

- The auto-latching design provides quick and secure Kolpin Stronghold product attachment

- Bracket is made from rugged high impact, reinforced nylon and coated steel with precision angle adjustment for a custom fit

- For use with the Kolpin Stronghold line of products (sold separately)

» 2882272 • \$94⁹⁹

SPORTSMAN 850/1000 '17-22

Does not fit with Ultimate Series – Body Armor (2882090)

STRONGHOLD AUTO-LATCH MOUNT

- The Aauto-latching design provides quick and secure Kolpin Stronghold product attachment

- Bracket is made from rugged high impact, reinforced nylon and coated steel with precision angle adjustment for a custom fit

- For use with the Kolpin Stronghold line of products (sold separately)

» 2884846 • \$94⁹⁹

SPORTSMAN 450/570 '21-22

STEP 2 CHOOSE YOUR BOOT



GUN BOOT L

- 52" L x 4¾" W x 9¾" H

- Requires Auto-Latch Mount 2882272 or 2884846 to mount to vehicle

» 2882426 • \$83⁹⁹

SPORTSMAN 850/1000 '17-22,
SPORTSMAN 450/570 '14-22



GUN BOOT XL

- Lockable and TSA Approved

- Includes padded, zippered internal protective liner

- 52" L x 3¾" W x 10½" H

- Requires Auto-Latch Mount 2882272 or 2884846 to mount to vehicle

» 2882036 • \$109⁹⁹

XP 1000 '17-22, 850 '17-22, 570 '19-22, 450 H.O '21-22



KOLPIN RHINO GRIP

IDEAL FOR CARRYING RIFLES, SHOTGUNS, BOWS AND CROSSBOWS.



LOCK & RIDE RHINO GRIP PRO

» 2884119 • \$109⁹⁹

» 2884109 • REPLACEMENT RUBBER STRAPS • \$11⁹⁹

ALL SPORTSMAN MODELS
(EXCEPT UTILITY EDITIONS & YOUTH)



LOCK & RIDE RATCHETING RHINO GRIP

» 2881157 • \$83⁹⁹

ALL SPORTSMAN MODELS (EXCEPT UTILITY AND YOUTH)



LOCK & RIDE RHINO GRIP XLR

» 2889147 • \$55⁹⁹

» 2889204 • RHINO GRIP XLR REPLACEMENT RUBBER STRAPS (2) • \$11⁹⁹

ALL SPORTSMAN MODELS
(EXCEPT UTILITY EDITIONS & YOUTH)



LOCK & RIDE RHINO GRIP XLR – DOUBLES

» 2889148 • \$90⁹⁹

» 2889204 • RHINO GRIP XLR REPLACEMENT RUBBER STRAPS (2) • \$11⁹⁹

ALL SPORTSMAN MODELS
(EXCEPT UTILITY EDITIONS & YOUTH)



KOLPIN GUN BOOT IV

- For 50mm scopes, rifles with slings attached, or shotguns up to 51" in length

» BLACK • 2872677 • \$83⁹⁹



LOCK & RIDE GUN BOOT MOUNTS

- Works with Lock & Ride XL Storage Box, Lock & Ride Rear Cargo Box, and Rear Rack Extenders

» 2878001 • \$169⁹⁹

SPORTSMAN 850/1000 TOURING '10-22

Only Compatible with Kolpin Gun Boot IV – Not Compatible with Kolpin Stronghold Gun Boots

KEEP IT ICE COLD



GRIZZLY TESTED. POLARIS APPROVED.



This cooler is IGBC-approved, meaning it withstands the power expended by a typical grizzly bear if it was trying to get inside.

Seriously, there are experts who know what a grizzly is capable of doing, and they certify our coolers can take it.



30, 60 & 105 QUART FEATURES



ComfortCarry
Handles



TravelLock
System



EasyOut
Drain System



NoSlip
Rubber Feet



PolarWall
Insulation



IceLock
Seal

POLARIS NORTHSTAR COOLERS CAN SURVIVE JUST ABOUT ANYTHING - FROM EXTREME HEAT TO A NASTY TUMBLE OFF A VEHICLE.



105 QUART

- » GRAPHITE • 2883426 • \$509⁹⁹
- » DESERT • 2883392 • \$509⁹⁹



60 QUART

- » GRAPHITE • 2883425 • \$409⁹⁹
- » DESERT • 2881259 • \$409⁹⁹



30 QUART

- » GRAPHITE • 2883424 • \$309⁹⁹
- » DESERT • 2881315 • \$309⁹⁹



15 QUART

- » GRAPHITE • 2883968 • \$249⁹⁹



NEW 20 QUART
SOFT-SIDED COOLER

- » GRAPHITE • 2889285 • \$219⁹⁹

ESSENTIAL ACCESSORIES SO YOUR COOLER WORKS AS HARD AS YOU DO

COOLER ACCESSORIES	105 QUART	60 QUART	30 QUART	DON'T FORGET THESE ACCESSORIES	
<p>WIRE BASKET</p>	2883648 • \$59 ⁹⁹	2882185 • \$43 ⁹⁹	2882438 • \$36 ⁹⁹	<p>30 oz</p> <p>TUMBLERS</p> <ul style="list-style-type: none"> » 30 OZ • 2883394 • \$36⁹⁹ » 20 OZ • 2883393 • \$30⁹⁹ 	<p>BOTTLE OPENER</p> <ul style="list-style-type: none"> » 2882183 • \$15⁹⁹ ALL COOLERS
<p>DIVIDERS Doubles as cutting board</p>	2883468 • \$43 ⁹⁹ COMES WITH ONE DIVIDER	2882184 • \$59 ⁹⁹ COMES WITH TWO DIVIDERS	2882186 • \$30 ⁹⁹ COMES WITH ONE DIVIDER		
<p>SEAT CUSHION</p>	NOT AVAILABLE	2882179 • \$114 ⁹⁹	2882507 • \$89 ⁹⁹		
<p>WHEELS</p>	2883967 • \$119 ⁹⁹	2882180 • \$124 ⁹⁹	NOT AVAILABLE		

HOLDS ICE
30+
HOURS
LONGER
THAN YETI^{**}

**YETI is a registered trademark of YETI COOLERS, LLC

FOR THE LIFE OF YOUR RIDE

PARTS THAT PUSH THE LIMITS WITHOUT SACRIFICING STRENGTH AND DURABILITY.

We build our products so anyone with the right tools can maintain their vehicle.

POLARIS

ENGINEERED PARTS & LUBRICANTS

PARTS & GARAGE

MAINTENANCE

OIL & LUBRICANTS

MAINTENANCE FLUIDS

BATTERIES & GARAGE ACCESSORIES

HO PARTS

SERVICE PARTS

TIRE SEALANT & TRAILERING

POLARIS POWER

MAINTENANCE

54

MAINTENANCE TIP

BREAK-IN PERIOD

The break-in period for your new SPORTSMAN is the first 25 hours of operation, or the time it takes to use the first two tanks of fuel. No single action on your part is as important as a proper break-in period. Careful treatment of a new engine will result in more efficient performance and longer life for the engine.

NOTICE: Excessive heat build-up during the first three hours of operation will damage close-fitted engine parts. Do not operate at full throttle or high speeds for extended periods during the first three hours of use.

SEE OUR LATEST MAINTENANCE TIPS AT ATV.POLARIS.COM/EN-CA/SELF-HELP

BATTERY

To ensure a battery maintains its level of charge when unused for extended periods of time or during freezing weather, the battery should be connected to a BatteryMINDER® (see P. 60). Be sure to check for corrosion from the terminals to the ends of the cables.

BRAKE PADS

Maintaining and/or replacing brakes are critical to the safety and functionality of a vehicle. Brake pads should be checked for wear and oil or grease (petroleum products) contamination and brake discs should be checked for cracks, excessive corrosion or warping.

HALF SHAFT

Check for tears and punctures in the boot, which can lead to CV joint wear that can contribute to axle failure.

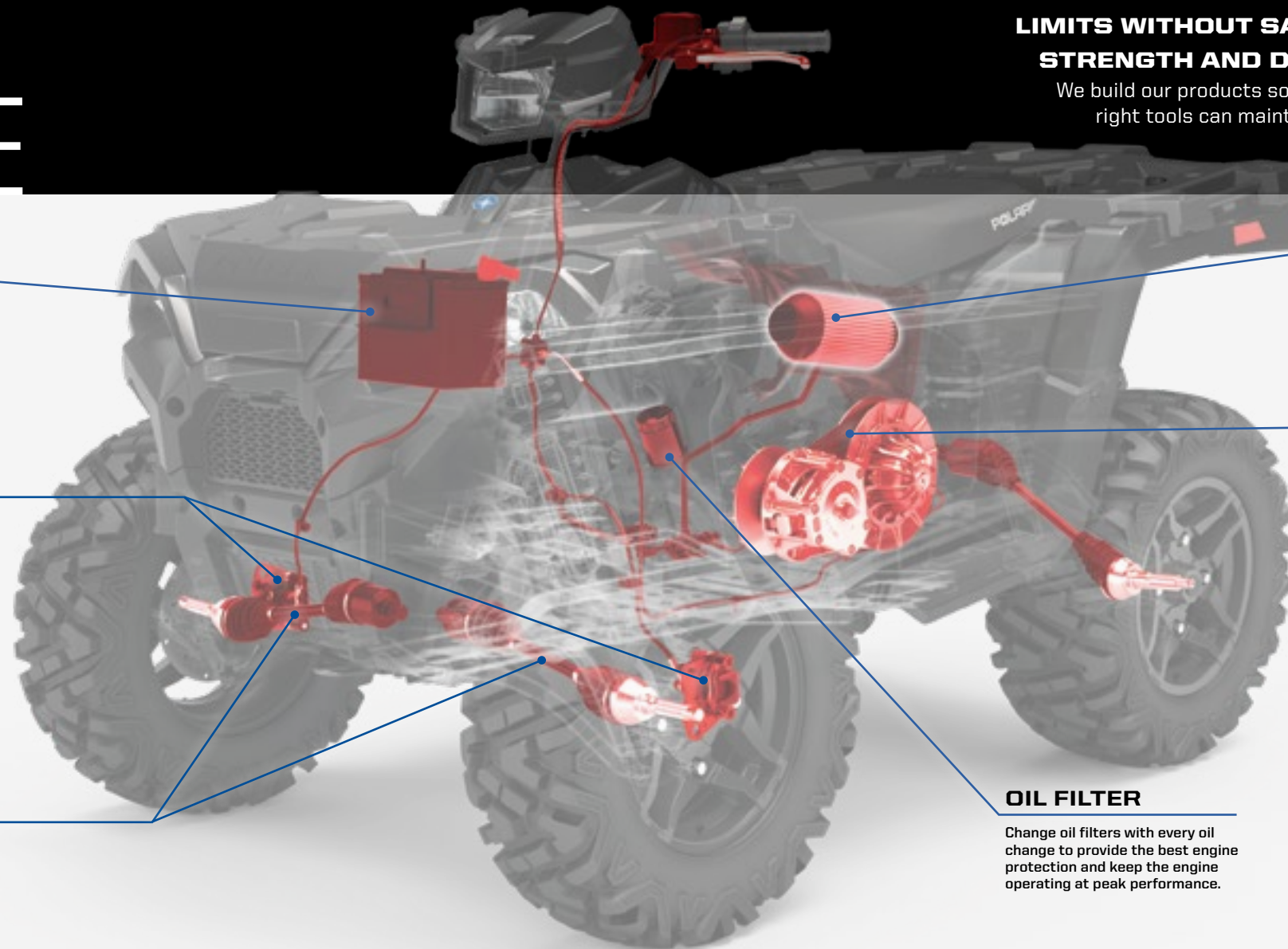

AIR FILTER

A clogged air filter can restrict air flow to the engine leading to reduced engine performance, engine life or catastrophic failure.

DRIVE BELT

Polaris Engineered belts deliver unmatched performance for your off-road vehicle. Developed and tested on all our engines for all environments and conditions. Check your belt for delamination, hour glassing and glazing.

BREAK-IN PERIOD

- Use lower gear (if available) while varying speeds and avoid wide open throttle for 5-10 miles / 8-16 km
- If no low gear is available, vary at moderate speeds while avoiding wide open throttle for 50 miles / 80 km

OUR INVESTMENT

- 40,000+ miles / 32,187 km of field testing
- Thousands of dyno hours
- 18+ months of development (13,000+ design hours) per belt
- 1,500+ vehicle validation hours
- Collaboration with powertrain and clutch engineers

YOUR ADVANTAGE

- No clutch recalibration
- Less wear and tear due to heat
- Ensure maximum vehicle performance
- More time riding, less time wrenching
- Produced in collaboration with powertrain and clutch engineers to ensure a perfect fit, maximum performance and ultimate durability

OIL FILTER

Change oil filters with every oil change to provide the best engine protection and keep the engine operating at peak performance.

FOLLOW RECOMMENDED SERVICE INTERVALS IN THE OWNER'S MANUAL

MAINTENANCE SCHEDULE

25 HRS / 250 Mi / 400 km

BREAK-IN MAINTENANCE

- ENGINE OIL:** CHANGE
- GEARCASES:** CHECK OIL LEVEL
- AIR FILTER:** INSPECT & REPLACE AS NEEDED
- EXHAUST SYSTEM:** INSPECT & CLEAN
INSPECT FOR LEAKAGE OR CARBON BUILD UP AT JOINTS
INSPECT & CLEAN SCREEN TYPE SPARK ARRESTOR

50 HRS / 500 Mi / 800 km

6 MONTHS

- EXHAUST SYSTEM:** INSPECT & CLEAN
INSPECT FOR LEAKAGE OR CARBON BUILD UP AT JOINTS
INSPECT & CLEAN SCREEN TYPE SPARK ARRESTOR
- GENERAL LUBRICATION:** ALL FITTINGS, PIVOTS, CABLES, ETC.
- DRIVE BELT:** INSPECT & ADJUST
REPLACE AS NEEDED

100 HRS / 1,000 Mi / 1,600 km

12 MONTHS

- ENGINE OIL:** CHANGE
- DRIVE BELT:** INSPECT & ADJUST
REPLACE AS NEEDED
- SPARK PLUGS:** REPLACE
- EXHAUST SYSTEM:** INSPECT & CLEAN
INSPECT FOR LEAKAGE OR CARBON BUILD UP AT JOINTS
INSPECT & CLEAN SCREEN TYPE SPARK ARRESTOR

150 HRS / 1,500 Mi / 2,400 km

18 MONTHS

- BATTERY:** TEST, CLEAN & CHECK FLUID LEVEL
IF NECESSARY, REPLACE AS NEEDED
- DRIVE BELT:** INSPECT & ADJUST
REPLACE AS NEEDED
- TIRES:** INSPECT CONDITION & PRESSURE
- EXHAUST SYSTEM:** INSPECT & CLEAN
INSPECT FOR LEAKAGE OR CARBON BUILD UP AT JOINTS
INSPECT & CLEAN SCREEN TYPE SPARK ARRESTOR

200 HRS / 2,000 Mi / 3,200 km

24 MONTHS

- ENGINE OIL:** CHANGE
- TRANSMISSION FLUID:** CHANGE
- GEARCASES:** CHECK OIL LEVEL
- BRAKE PADS & FLUID:** INSPECT & CLEAN
REPLACE AS NEEDED
- SPARK PLUGS:** REPLACE
- EXHAUST SYSTEM:** INSPECT & CLEAN
INSPECT FOR LEAKAGE OR CARBON BUILD UP AT JOINTS
INSPECT & CLEAN SCREEN TYPE SPARK ARRESTOR

250 HRS / 2,500 Mi / 4,023 km

30 MONTHS

- ENGINE OIL:** CHANGE
- BATTERY:** TEST, CLEAN & CHECK FLUID LEVEL
REPLACE AS NEEDED
- DRIVE BELT:** INSPECT & ADJUST
REPLACE AS NEEDED
- GENERAL LUBRICATION:** ALL FITTINGS, PIVOTS, CABLES, ETC.
- EXHAUST SYSTEM:** INSPECT & CLEAN
INSPECT FOR LEAKAGE OR CARBON BUILD UP AT JOINTS
INSPECT & CLEAN SCREEN TYPE SPARK ARRESTOR

300 HRS / 3,000 Mi / 4,828 km

36 MONTHS

- ENGINE OIL:** CHANGE
- AIR FILTER:** INSPECT & REPLACE AS NEEDED
- GEARCASES:** CHECK OIL LEVEL
- SPARK PLUGS:** REPLACE
- EXHAUST SYSTEM:** INSPECT & CLEAN
INSPECT FOR LEAKAGE OR CARBON BUILD UP AT JOINTS
INSPECT & CLEAN SCREEN TYPE SPARK ARRESTOR

CHECK YOUR OWNER'S MANUAL FOR ADDITIONAL RECOMMENDED SERVICE ITEMS AND VEHICLE-SPECIFIC TIMING

OIL



NEW PS-4 FORMULATIONS BEST PROTECTION, BEST PERFORMANCE

Our new PS-4 5W-50 formulation and PS-4 Extreme Synthetic 0W-50 have been designed to provide the best fluid technologies for long lasting wear protection. These formulations include a new Polaris exclusive additive system to keep the engine cleaner from deposit build-up to maximize power and powersports-grade synthetic base stocks that provide the ultimate in engine protection.

PS-4 5W-50 FULL-SYNTHETIC OIL

Optimal for ambient operating temperatures of -40° F to 100° F

- » 1 Quart 2876244
- » 1 Gallon 2876245
- » 16 Gallons 2876247
- » 55 Gallon Drum 2876246
- » 330 Gallon Tote 2878814

PS-4 0W-50 EXTREME FULL-SYNTHETIC OIL

Optimal for ambient operating temperatures of 0° F to 130° F

- » 1 Quart 2889395
- » 1 Gallon 2889396
- » 16 Gallons 2889397
- » 55 Gallon Drum 2889398
- » 330 Gallon Tote 2889399

OIL CHANGE KITS

PS-4	These convenient kits include everything needed including filter and oil volume per vehicle	PS-4 EXTREME
PART NUMBER	VEHICLE FITMENT	PART NUMBER
2202166	RANGER/RZR/SPORTSMAN 570, TWIN 600, TWIN 700, TWIN 800	2879004
2879323	RANGER, POLARIS GENERAL 900-1000, RZR 900-1000, RS1	2879324
2877473	RANGER/SPORTSMAN 300-500, SPORTSMAN/SCRAMBLER 500/850/1000	2878924
2881696	RZR TURBO	2881697

ENGINE WEAR TEST LOWER NUMBER = LESS WEAR OF CRITICAL ENGINE PARTS LESS WEAR MEANS LONGER ENGINE LIFE

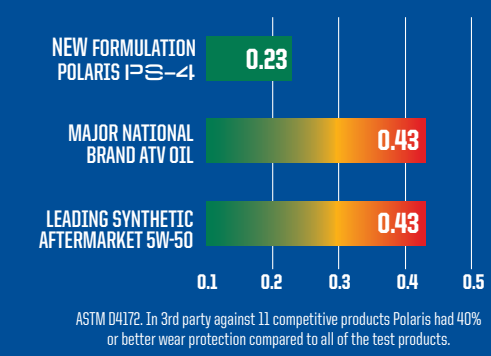

THE BEST PROTECTION

- At least 40% improved wear protection compared to previous Polaris PS-4 formulation and all aftermarket oils tested

Best engine protection against wear for the longest engine life.

DEPOSIT TEST LOWER DEPOSITS = MAXIMUM POWER

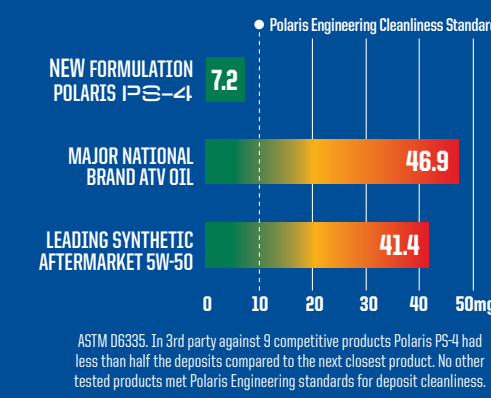

MAXIMUM PERFORMANCE

- New improved PS-4 formulation provides 33% less deposits than previous PS-4 formula
- At least 50% less deposits than all aftermarket oils tested

The cleanest engine for maximum power and performance!

POLARIS EXTREME SYNTHETICS

Our new PS-4 Extreme Synthetic 0W-50 formulation applies only to the **absolute highest performance** products we sell, for ultimate protection and performance in the most extreme conditions.



- Our best extreme high temp formulation, excellent for severe high temperatures and for racing, even at temps over 54°C.
- Provides easier starting and cold temperature protection, even to extreme cold temps of below -42°C.
- Latest in premium synthetic PAO and Ester base stocks along with careful balance of moly and ZDDP additives for ultimate long lasting wear protection.
- Polaris exclusive clean engine additive system reduces deposits and carbon build-up for peak performance and power.



POLARIS INVESTS IN EACH OIL AT AND ABOVE THESE LEVELS

12+ DEDICATED
TEAM MEMBERS
FOCUSED ON
POLARIS OIL

18+ MONTHS
DEVELOPMENT
& TESTING

76,000+ HOURS
DYNO TESTING

1.9 MILLION MILES (3,057,753 KM)
FIELD TESTING

MAINTENANCE FLUIDS



DOT 4 BRAKE FLUID

A high-quality brake fluid designed for use in Polaris hydraulic brakes.

Change every 200 hours, 24 months, or 2,000 miles / 3,200 km.

» 12 OZ • 2872189



AGL

Protect gears, drive chain and bearings from scoring and wear.

Change every 200 hours, 24 months or 2,000 miles / 3,218 km.

» 1 QT • 2878068
 » 1 GALLON • 2878069
 » 2.5 GALLONS • 2878070
 » 55 GALLONS • 2879594

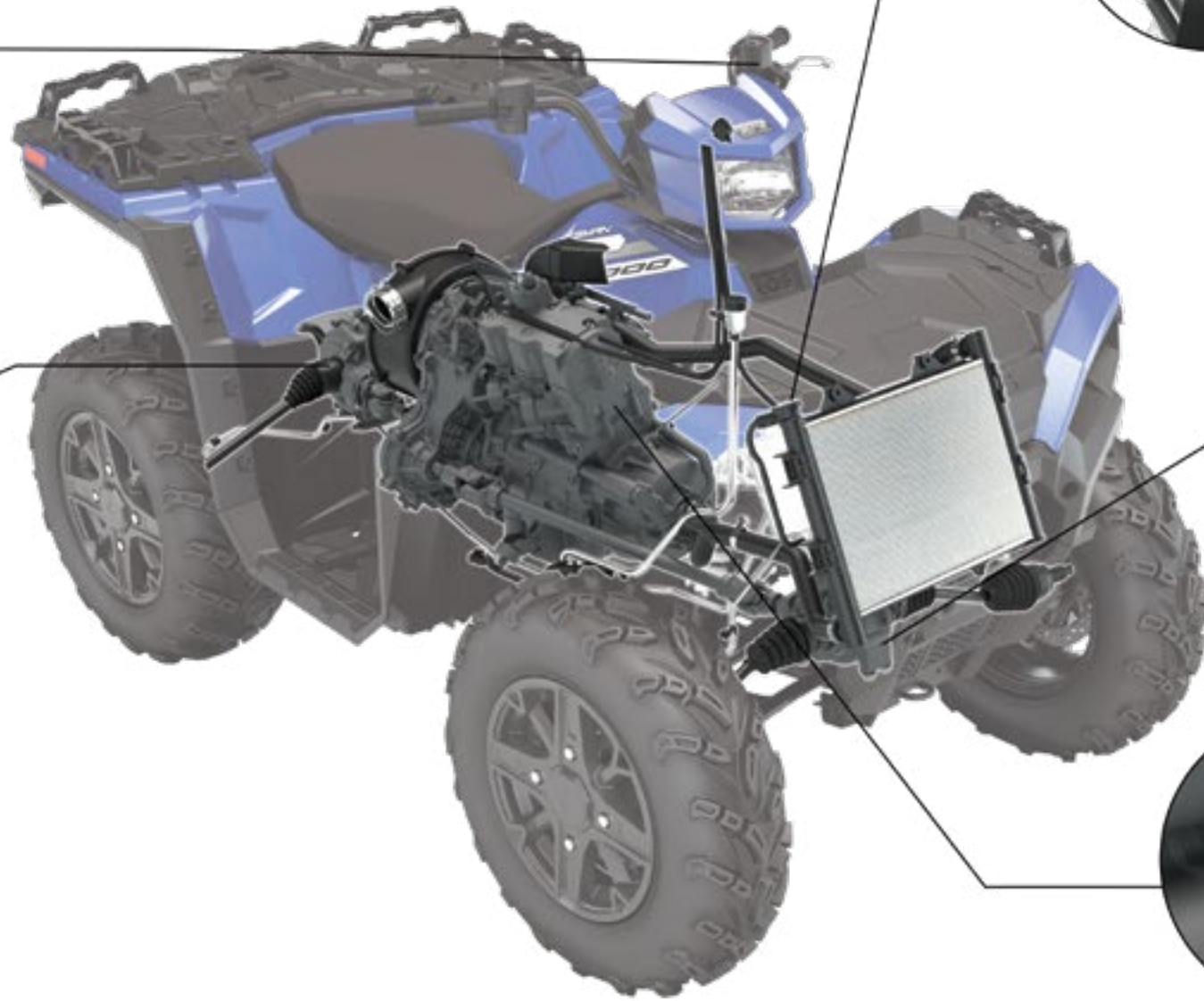

ANTI-FREEZE

Prevent corrosion on metal components, eliminate scaling and maximize cooling system performance.

Change every 60 months.

» 1 QT • 2880514
 » 1 GALLON • 2880513
 » 55 GALLONS • 2880512



DEMAND DRIVE FLUID

Provide positive 4WD engagement in extreme cold or high heat conditions and protect internal components under heavy loads.

Change every 100 hours or every 36 months.

» 1 QT • 2877922
 » 2.5 GALLONS • 2877923



ENGINE OIL

Maximum protection for your 4-cycle engine.

Change every 100 hours, 1,000 miles / 1,600 km or 12 months.



ORV MAINTENANCE KITS

Everything you need, in the correct fluid volumes, to maintain your drive train and keep your vehicle in top operating condition

• Includes: 1.5 quarts AGL, 1 quart Angle Drive Fluid, 1 pint Demand Drive Fluid, 1-3 OZ tube of All-Season Grease

» 2880425
 ALL MODELS

• Includes: 1 Spark Plug, 1 Air Filter, 2 quarts PS-4, 1 Oil Filter, 1 pint Demand Drive Fluid, 1 quart AGL, 1 Crush Washer, 1 Paper Funnel

» 2830549
 570 '14-22, 450 '16-22



PREMIUM GAS SHOCK OIL

» 1 QT • 2874124
 WALKER EVANS RACING® REBUILDABLE SHOCKS
 » 1 QT PREMIUM • 2870995
 » 2.5 GALLONS PREMIUM • 2872279
 FOX® REBUILDABLE SHOCKS



SUSPENSION/ U-JOINT GREASE

» 3 OZ • 2871515
 » 14 OZ • 2871551



CHAIN LUBRICANT

• Provides superior anti-wear and shock protection
 » 16 OZ AEROSOL 2872348



ALL-SEASON GREASE TUBE

• Specialized water-resistant lubricant
 » 3 OZ • 2871322
 » 14 OZ • 2871423



ANGLE DRIVE FLUID

• Extreme pressure, anti-wear and high viscosity film lubrication for maximum protection
 » 1 QT • 2876160
 » 2.5 GALLONS • 2872276
 SPORTSMAN, RANGER, RZR ANGLE DRIVE GEAR CASE SYSTEMS



GENERATOR OIL

• 4-cycle engine oil
 » 1 QT • 2879383



CARBON CLEAN

• Ultimate fuel and injection system cleaner
 » 12 OZ • 2881413



ADVANCED FUEL TREATMENT

• Dual antioxidant formula protects jets and fuel system from gum and varnish
 » 12 OZ • 2881416
 » 2.5 GALLONS • 2881417

BatteryMINDER®

ENSURE YOUR RIDE IS READY WHEN YOU ARE.

GARAGE ACCESSORIES

- Add years of capacity, power and range to new and older batteries, regardless of type or brand
- Never over- or under-charged in any temperature
- Leave your vehicle connected for months and return to fully charged and conditioned batteries
- Recover older or weak batteries that would normally need to be replaced

- Charge and maintain extra backup batteries, as well as those in your vehicle
- Automatic turn-on, sleeps while keeping your batteries at full charge
- Easy push-button selector to change battery type or time



NEW
PREMIUM MAINTENANCE TOOL KIT

- Includes everything you need to work on and repair Polaris vehicles
- Lifetime warranty on select tools

» 2830565 • **\$659⁹⁹**

NEW
1,000 AMP ULTRASAFE LITHIUM JUMP PACK

- Delivers 1,000 amps for jump starting a dead battery in seconds

» 2830547 • **\$169⁹⁹**

NEW
JUMP PACK PROTECTION CASE

- Lightweight, durable and rugged custom exterior

» 2830548 • **\$26⁹⁹**

FLEX SPOUT

- Fits all Polaris quart, gallon and 2.5 gallon bottles

» 2871285 • **\$3⁹⁹**

FLUID FUNNEL

- Easily add oil with high accuracy

» 2830552 • **\$17⁹⁹**

GREASE GUN

- Enables easy application of grease

» 2871312 • **\$44⁹⁹**
FITS 2871322 ALL-SEASON AND 2871515 U-JOINT 3 OZ

PUMP

- Fits 1 and 2.5 gallon bottles

» 2870465 • **\$9⁹⁹**

FLUID TRAY

- Holds up to 8 quarts of fluid

» 2830551 • **\$26⁹⁹**

2D BATTERY-OPERATED SIPHON PUMP

- Liquid transfer pumps 5-6 quarts/min suctioning power

» 2830513 • **\$20⁹⁹**

POLARIS SHOP TOWELS

- » 200 CT WITH DISPENSER (SHOWN) 2830402 • **\$28⁹⁹**
- » 200 CT REFILL • 2830403 • **\$19⁹⁹**
- » 64 CT REFILL • 2830440 • **\$6⁹⁹**

OIL FILTER WRENCH

- Remove Polaris ORV oil filters with ease

» 2830550 • **\$10⁹⁹**

FLUID SYRINGE

- Easily add and remove fluid from your vehicle

» 2830553 • **\$39⁹⁹**

POLARIS HEAVY-DUTY SCRUBBER WIPES

- » 90 CT • 2830441 • **\$24⁹⁹**

	2012 AGM 2 AMP	2012 LEAD ACID 2 AMP	1510 1.5 AMP	1.5 AMP CONVERTIBLE
PART NUMBER • PRICE	2830438 • \$121⁹⁹	2830531 • \$109⁹⁹	2830404 • \$79⁹⁹	2830511 • \$91⁴⁹
VOLTAGE • WARRANTY	12 V • 5 Years	12 V • 5 Years	12 V • 10 Years	12 V • 5 Years
CHARGING CURRENT	2 amp	2 amp	1.5 amp	1.5 amp
OVERCHARGE PROTECTION	Yes			
BATTERIES MAINTAINED	6 at one time		4 at one time	
BATTERY COMPATIBILITY	12 V Sealed AGM Lead-Acid	12 V Flooded (filler cap) and Sealed Maintenance-Free Batteries		
COMES WITH	• Non-fused battery clip cord set with Quick Connector	• BC-2410: 2' non-fused battery clip cord set with Quick Connector • RTA-2415: 2' fused ring terminal cord set with Quick Connector • ATS-1: Ambient temperature sensor	• Ambient temperature sensor (installed) • 12' power cord • Battery clip cord set with Quick Connector • Optional permanent mounting tab	• Auto-temp compensation sensor (installed) • Optional permanent mounting brackets and screws • Battery clips (fully-insulated, aircraft grade, 15A replaceable fuse) • Ring terminal assembly with 15A replaceable fuse
KEY FEATURES	Designed for high-performance specialty AGM sealed batteries	Diagnoses battery condition - can predict failing batteries	Easy to use, economical	Convertible on-vehicle or bench top use

BATTERY MAINTENANCE TIPS

Extend your battery life with a BatteryMINDER® and these tips:

1. Store batteries in a cool, dry location.
2. Check that the battery connections are tight. Cables should not be able to be rotated or shifted by hand.
3. If your battery has a drain tube, make sure it is free of clogs.
4. Clean your battery - use a soft brush to scrub the top of the battery. Use baking soda to remove grease.
5. Connect a BatteryMINDER® after using your vehicle even if the vehicle is in regular use.

BatteryMINDER® ACCESSORIES



BatteryMINDER® 12' CABLE

- Made with heavy-duty, 16-gauge black zip cord featuring automotive SAE bullet connectors

» 2830410 • **\$15⁹⁹**



BatteryMINDER® VPP-12:12/24 VOLT VEHICLE POWER PLUG

- Allows easy connection to vehicle battery through lighter or 12/24 V power port with replaceable 15 amp fuse

» 2830518 • **\$16⁹⁹**



BatteryMINDER® SPLITTER

- Connect two batteries simultaneously for easy battery maintenance
- Cap includes a set of ring terminals

» 2830409 • **\$45⁹⁹**



BatteryMINDER® RING TERMINAL

- Features 24" long 18-gauge wire
- Plug has standard 5/16" negative and 3/8" positive terminals
- Replaceable 15 amp in-line fuse for circuit protection

» 2830437 • **\$12⁹⁹**



BatteryMINDER® EZ CONNECT

- Allows for quick, easy connecting and disconnecting of your BatteryMINDER®
- Includes a set of ring terminals

» 2830411 • **\$32⁹⁹**



POLARIS X3 CREEPER

- Three positions: Flat, 45-degree angle or seated work stool
- Helps you perform any repair with ease
- Stay dry and warm away from cold, wet cement floors
- Easily stores away when not in use

» BLACK • 2830429 • **\$179⁹⁹**



POLARIS MAGNETIC PARTS TRAY

» SILVER • 2830432 • **\$15⁹⁹**



POLARIS 33" TELESCOPIC MAGNET

» BLACK • 2830435 • **\$6⁹⁹**



POLARIS 12" HI-TORQUE RATCHETING DRIVER

» BLACK / BLUE • 2830434 • **\$24⁹⁹**



POLARIS LED POCKET FLASHLIGHT

» BLACK • 2830436 • **\$30⁹⁹**

HD HEAVY DUTY PARTS

All Polaris parts are developed and tested to help you get the most out of your ride. We're taking the passion of our riders, workers and outdoor enthusiasts to the next level with HD Parts.

Engineered and designed for:

- Greater durability
- Enhanced performance
- Greater wear and tear capabilities
- All weather conditions

NEW OIL FILTERS

The advanced synthetic material built into these filters offers the highest debris holding capacity, maintains oil flow and maximizes performance.

OE	HD HEAVY DUTY PARTS
2520799	2522485
2540086	2522498

WHEEL BEARINGS

Fully sealed for added protection against intrusions. Made of a higher grade steel for extended life in extreme conditions.

LOCATION	OE	HD HEAVY DUTY PARTS
FRONT WHEEL BEARINGS	3514822	3515090
	3514634	3515088
REAR WHEEL BEARINGS	3514917	3515087

WHEELS & TIRES

Class leading durability for off-road performance and traction for confident driving in extreme conditions.

- » 1524022-458 • HD WHEEL - 14x7
- » 5457498-458 • HD WHEEL CENTER CAP

NEW DRIVE BELTS

The enhanced rubber material compound in these belts keep them cool in extreme heat, while our patented cord treatment process maximizes the transfer of horsepower to the ground for those customers hauling heavy loads.

OE	HD HEAVY DUTY PARTS
3211149	3212326
3211077	3212328
3211113	3212332
3211160	3212331

BUSHINGS

The advanced material compound of the bushings enables tighter tolerances to reduce overall wear on the system, while the superior triple lip sealing prevents intrusion of the elements.

LOCATION	OE	HD HEAVY DUTY PARTS
FRONT UPPER BUSHINGS	5439874	1543367
FRONT LOWER BUSHINGS	5439874	1543367
	5436973	1543326
REAR UPPER BUSHINGS	5439874	1543367
	5438895	1543326
REAR LOWER BUSHINGS	5439874	1543367
	5436973	1543326

BRAKES

Engineered to provide longer life and better stopping power while riding in extreme conditions.

LOCATION	OE	HD HEAVY DUTY PARTS
FRONT	2205949	2208933
FRONT/REAR	2202413	2208934
	2202412	2208935

BUSHING KITS

Easily update the entire front and rear suspension.

- » 2830562 (SHOWN)
570 EFI '16-'20, 570 EFI X2 '16-'20, 570 EFI TOURING '16-'20, 570 EPS UTILITY '20, 450 HO '16-'20, 450 UTILITY '20
- » 2830563
570 SP '16-'19, 570 PREMIUM '19, 570 SP TOURING '16-'20

Claims made based off testing and performance of Polaris HD Parts against standard OEM parts made by Polaris and competitor brands under normal use.

For more information regarding Polaris HD parts including vehicle compatibility, installation and maintenance, please contact your authorized Polaris ORV dealer.

VISIT POLARIS.COM/SHOPPARTS TO LEARN MORE

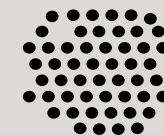

SAND



MUD



WATER



EXTREME COLD



EXTREME HEAT UP TO 130° F



HEAVY PAYLOADS



EXTENDED LIFE

PARTS & GARAGE

MAINTENANCE

OIL & LUBRICANTS

MAINTENANCE FLUIDS

BATTERIES & GARAGE ACCESSORIES

HD PARTS

SERVICE PARTS

TIRE SEALANT & TRAILERING

POLARIS POWER

SERVICE PARTS

OVER
100,000 PARTS
AVAILABLE!

Polaris Engineered service parts deliver unmatched performance and fit for your off-road vehicle.

All service parts are engineered specifically for your machine. Which means everything is designed, tested and perfected to maximize the life of your ride. Getting Polaris Engineered parts is a decision that pays off in the long run, because it ensures there is a long run.



**SHOP FOR SERVICE PARTS ONLINE
OR VISIT YOUR POLARIS DEALER.**

CHECK OUT OUR PARTS FINDER ON POLARIS.COM

FOR EASY PARTS LOOK-UP, PARTS IDENTIFICATION, VIEWS OF ASSEMBLIES & MORE!

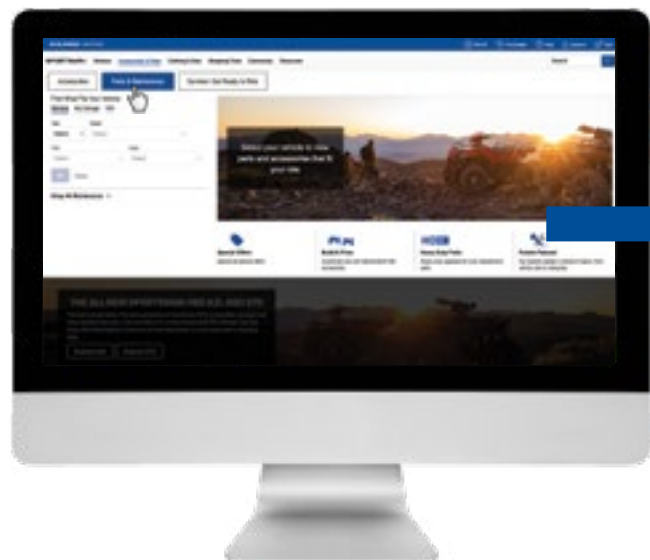

STEP 1

Visit **Polaris.com/SPORTSMAN**
Click the **"Accessories & Parts"** tab
Click **"Parts & Maintenance"**

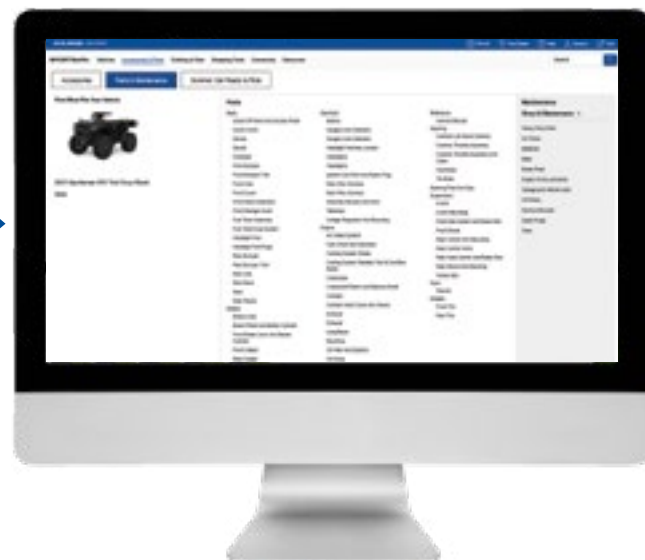

STEP 2

Enter **vehicle year/model** or
shop by **part number**



STEP 3

Clearly see what parts are
required and **order**

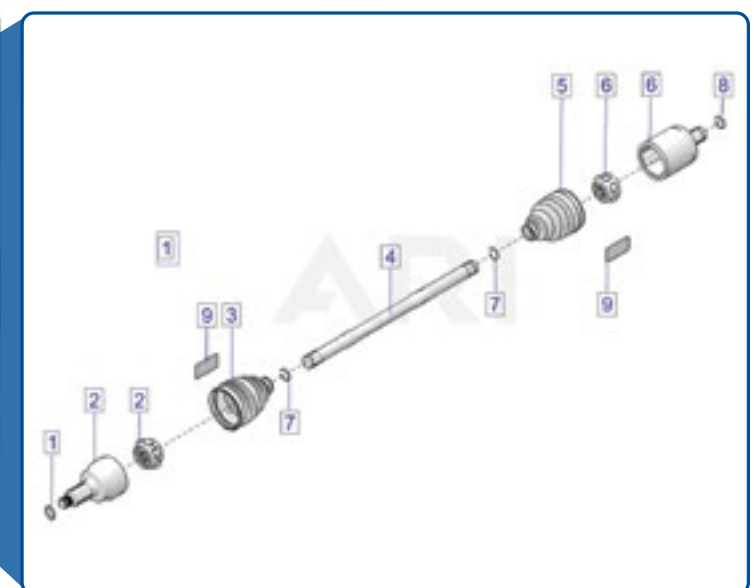

CV BOOT REPAIR KIT*

FIX ON THE GO | TEMPORARY COVERAGE

- A quick trail-side fix to increase trail time
- The flexible and durable boot material expands "over a cone tool for CV boot repairs, without disassembling CV axles
- Universal fit - works as a temporary fix for most powersports axles
- All components fit inside the cone, and a cover is provided for compact durable storage
- Easily fits in a cargo box, attached to the roll cage, in the glovebox or many other storage locations



Items shown are contained inside cone

ATV CV BOOT REPAIR KIT

Kit includes the following items:

- (1) Expandable CV Boot
- (1) Reusable Cone Tool
- (2) CV Boot Clamps
- (1) Tube of Silicone Lube
- (1) Grease Packet
- (1) Cone Cover

» 2830528 • \$31⁹⁹

ATV TRAIL BOOT ONLY

» 2830529 • \$18⁹⁹

UTV

- CV REPAIR KIT 2830526 • \$36⁹⁹
- TRAIL BOOT ONLY 2830527 • \$18⁹⁹

SEE HOW THE CV BOOT REPAIR KIT WORKS AT POLARIS.COM/MAINTENANCE-VIDEOS

HOW TO INSTALL

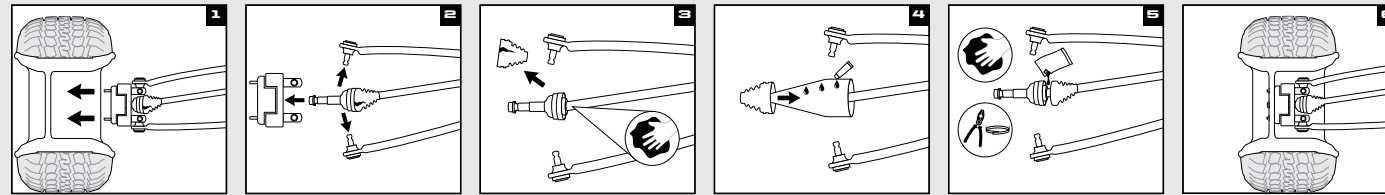

- Remove wheel and axle nut.
- Remove brake caliper, hub, tie rod and upper and lower ball joints.
- Remove old boot and clean joint.
- Spread silicone lube on entire cone tool. Slide boot over cone tool, large end first. See package for outer boot instructions.
- Empty the bag of grease into the CV joint/boot, clean sealing points and install clamps.
- Reassemble tie rod, ball joints, brake caliper, axle nut, tire and wheel.

Refer to your service manual for further instructions and torque specifications.
*Designed for temporary CV boot repair. Purchase the OEM CV Boot for a permanent repair.

TIRE SEALANT



Once a leak occurs, the tire sealant rushes out of the tire and quickly creates a permanent solid plug.

The plug maintains the pressure of the tire so you can continue your ride.

HOW IT WORKS

Tire sealant remains liquefied inside the tire until a leak develops in the tire or wheel.

HOW MUCH TIRE SEALANT DO YOU NEED?

$$\begin{array}{r} \text{TIRE HEIGHT (IN.)} \times \text{TIRE WIDTH (IN.)} / 5 = \text{OUNCES REQUIRED PER TIRE} \\ | \qquad \qquad \qquad | \qquad \qquad \qquad | \\ 27" \times 10" / 5 = 54 \text{ oz} \end{array}$$

FOR A FULL APPLICATION CHART, VISIT POLARIS.COM/TIRESEALANTCHART

PREMIUM TIRE SEALANT

- Instantly seals and repairs rim, bead leaks and punctures up to .25" on standard tires and .75" on heavy ply tires
- Helps maintain air pressure for the life of the tire
- Helps seal the tire bead against the wheel
- 100% water soluble for easy cleanup
- Will not rust, corrode or pit wheels
- Creates permanent repair
- Remains fluid and effective in temperatures down to -45° F
- Easily installed through existing tire valve stem with valve core removed

- » 32 OZ • 2830484 • \$25⁹⁹
- » 1 GALLON • 2830485 • \$89⁹⁹
- » 5 GALLONS • 2830486 • \$364⁹⁹
- » 5 GALLONS, PUMP • 2830487 • \$163⁹⁹
- » 55 GALLONS • 2830489
- » 275 GALLONS • 2830488

BRING IT EVERYWHERE

TRAILERING



CALIBER® RAMP PRO

- Designed for ATVs and UTVs up to 50" wide
 - Integrated grip glides for ultimate traction
 - Folding sides for easy transportation and storing
- » 52" x 90" • 2884576 • \$519⁹⁹



ALUMINUM ARCHED LOADING RAMPS

- Capacity for up to 3,000 lb
- » 76" x 12" • 2,000 lb • 2875384 • \$399⁹⁹
» 88" x 12" • 3,000 lb • 2875386 • \$649⁹⁹



LIGHTWEIGHT TRI-FOLD RAMPS

- Ramp folds up for transport
 - Capacity for up to 1,500 lbs
 - Safety straps included
- » 72" x 51" • 2875385 • \$389⁹⁹
» 82" x 51" • 2875860 • \$399⁹⁹



FOLDING ALUMINUM ARCHED RAMPS

- Ramp folds up for transport
 - Up to 1,500 lb total capacity, per individual ramp
 - Safety straps included
- » 88" x 12" • 2875387 • \$569⁹⁹

HITCHES

3:1 HITCHES VERSATILE 3 IN 1 FUNCTIONALITY

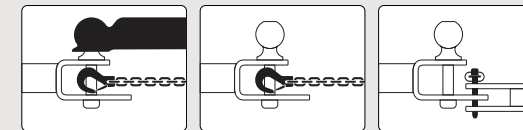

- Ball, hook and pin design
- Durable, rust resistant steel with black powdercoated finish
- Removable ball
- HD 5/8" pin and clip



HITCH WITH 2" BALL

- » 2" x 2" 2" RECEIVER 2830522 • \$48⁹⁹
- » 1 1/4" x 1 1/4" 2" RECEIVER 2830523 • \$48⁹⁹



1 7/8" BALL

- 1 7/8" replacement ball for hitch
 - Designed to work with 3:1 Hitch
- » 2830524 • \$12⁹⁹



RECEIVER HITCH

- » 2" RECEIVER TONGUE 2875320 • \$59⁹⁹

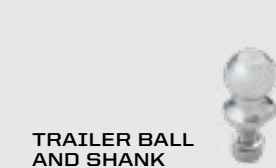

TRAILER BALL AND SHANK

- » 1 7/8" BALL • 2877602 • \$18⁹⁹
- » 2" BALL • 2877603 • \$18⁹⁹

STRAPS & ROPES



RECOVERY STRAP

- 2" x 30'
 - 18,000 lb maximum load / 9,000 lb maximum vehicle weight
 - Comes with carry bag
- » 2884033 • \$74⁹⁹



RATCHET STRAP

- 1.5" x 15' straps, 2 Pack
 - Heavy duty webbing
 - 5,500 lb maximum load, 1,833 lb working load
- » 2884031 • \$59⁹⁹



RATCHET STRAP

- 2" x 20' Ratchet Straps
 - Heavy duty webbing, floating D-rings, double J-hooks
 - 10,000 lb maximum load, 3,300 lb working load
- » 2884032 • \$43⁹⁹



SHOCK STRAPS

- 1.5" 3,000 lb breaking strength
 - Keeps tension on tie-down straps to secure load, 2 Pack
- » 1.5" x 15' • 2883296 • \$109⁹⁹
» 1.5" x 7' • 2883295 • \$94⁹⁹

COVERS

TRAILERABLE COVER

- » 2876614 • \$234⁹⁹
SPORTSMAN 450/570, SPORTSMAN 850/1000 REPLACEMENT STRAP 2871912.
- » 2877999 • \$234⁹⁹
ALL SPORTSMAN TOURING REPLACEMENT STRAP 2871912.
- » 2884188 • \$234⁹⁹
XP 1000 S, SCRAMBLER XP 1000 S



POLARIS POWER

FOR THE WORKERS, PLAYERS
AND SAVE-THE-DAYERS.



THE POWER TO EMPOWER

At Polaris Power, we are committed to powering more.
We proudly donate 3% of our profits by providing
portable power to areas affected by natural disasters
and the organizations providing relief in North America.

PARTS & GARAGE

MAINTENANCE

OIL & LUBRICANTS

MAINTENANCE
FLUIDS

BATTERIES & GARAGE
ACCESSORIES

HD PARTS

SERVICE PARTS

TIRE SEALANT
& TRAILERING

POLARIS POWER



P2000i

Inverter Generator

2830532

\$899⁹⁹

1600 Running Watts	2000 Starting Watts	16.7 Max Amps at 120V	7.6 Run Time at 25% Load w/ Smart Throttle (hrs)	62 Noise Level at 25% Load (dBA)
------------------------------	-------------------------------	---------------------------------	--	--

FEATURES



Extension Cord Management



Multi Functional Digital Display



Illuminated Control Panel



Multi Handle Design



Parallel Capable

BEST USED FOR



Tailgating



Off-Grid



Camping



ACCESSORIES 2830536 INVERTER PARALLEL KIT
2830540 ALL WEATHER COVER

2884865 HIGH ALTITUDE MODIFICATION KIT
2879383 GENERATOR OIL

P3200iE

Inverter Generator

2830533

\$1,899⁹⁹

2800 Running Watts	3200 Starting Watts	23.3 Max Amps at 120V	10.1 Run Time at 25% Load w/ Smart Throttle (hrs)	67 Noise Level at 25% Load (dBA)
------------------------------	-------------------------------	---------------------------------	---	--

FEATURES



Key Fob Remote Start



Multi Functional Digital Display



Fuel Gauge



Extension Cord Management



Parallel Capable

BEST USED FOR



DIY Remodeling



One Room Backup



Camping



ACCESSORIES 2830536 INVERTER PARALLEL KIT
2830541 ALL WEATHER COVER

2884866 HIGH ALTITUDE MODIFICATION KIT
2879383 GENERATOR OIL



P5500

Open Frame Generator

2830534

\$1,799 99

5000
Running
Watts

5500
Starting
Watts

20/30
Max Amps
at 120/240V

5
Run Time
(hrs)

75
Noise Level
(dBA)

FEATURES



Extension Cord Management



Fuel Gauge



Electric Start



Rough Terrain Wheel

BEST USED FOR



Construction



Home Backup



RV'ing



ACCESSORIES

2830542
2884867

ALL WEATHER COVER
HIGH ALTITUDE MODIFICATION KIT

2879383 GENERATOR OIL

P6500

Open Frame Generator

2830535

\$1,999 99

6000
Running
Watts

6500
Starting
Watts

20/30
Max Amps
at 120/240V

5
Run Time
(hrs)

75
Noise Level
(dBA)

FEATURES



Extension Cord Management



Fuel Gauge



Electric Start



Rough Terrain Wheel

BEST USED FOR



Construction



Home Backup



RV'ing



ACCESSORIES

2830542
2884867

ALL WEATHER COVER
HIGH ALTITUDE MODIFICATION KIT

2879383 GENERATOR OIL



APPAREL

Take your pick from our wide assortment of comfortable and stylish riding gear and casual wear. You'll find jerseys, t-shirts, sweatshirts, jackets, ballcaps and more that reflect your unique style on and off the trail.





NEW
OFF-ROAD RIDING JERSEYS

\$43⁹⁹

Mesh ventilated panels for maximum airflow
Elastic sleeves with non-restrictive cuffs

NEW
OFF-ROAD RIDING GLOVES

\$30⁹⁹

Adjustable wrist closure for a custom fit
Silicon finger grips and neoprene knuckle protection



TEKVEST® FREESTYLE

\$433⁹⁹

Black | S-3XL | 2862577



BLACK
JERSEY | S-3XL | 2862718
GLOVE | S-3XL | 2862726

ORANGE
JERSEY | S-3XL | 2862719
GLOVE | S-3XL | 2862729

TEAL
JERSEY | S-3XL | 2862720
GLOVE | S-3XL | 2862727

GREEN
JERSEY | S-3XL | 2862721
GLOVE | S-3XL | 2862730

BLUE
JERSEY | S-3XL | 2862722
GLOVE | S-3XL | 2862728

YOUTH JERSEY
\$37⁹⁹
S-XL | 2862723

YOUTH JERSEY
\$37⁹⁹
S-XL | 2862724

YOUTH JERSEY
\$37⁹⁹
S-XL | 2862725



SHORT SLEEVE
\$45⁹⁹
Men's | S-3XL | 2860634
Women's | S-3XL | 2860636



LONG SLEEVE
\$58⁹⁹
Men's | S-3XL | 2860638
Women's | S-3XL | 2860640



RAIN JACKET
\$129⁹⁹
Gray | S-3XL | 2869527



RAIN PANTS
\$109⁹⁹
Gray | S-3XL | 2869528

COOLING SHIRTS

FABRIC TECHNOLOGY DESIGNED TO KEEP YOU COOL

- Chemical-free fabric, Coolcore® reduces the surface temperature up to 30% so you don't overheat
- Carries a 50 Ultraviolet Protection Factor rating, blocking 98% of harmful UV rays



RAIN JACKET & PANTS

PACKABLE WATERPROOF PROTECTION AGAINST UNPREDICTABLE WEATHER

- 100% waterproof, lightweight and packable nylon
- YKK® zippers
- Rain jacket has removable hood

HELMETS

FOR
POLARIS

NEW
TAN
XS-4XL
2862472



ALTITUDE

509 ALTITUDE 2.0 HELMET

LIGHTWEIGHT DESIGN, PERFORMANCE-INFUSED STYLE AND FEATURES WITH ALL-DAY COMFORT

SHELL **\$371⁹⁵**

- Strong, lightweight construction of carbon fiber or fiberglass

WEIGHT

- Composite as low as 1,260g
- Carbon fiber as low as 1,150g

FEATURES

- Superior fit for all-day comfort
- Removable Pro Series breath box provides excellent ventilation and air flow
- One-piece eyepoint creates draft-free seal with 509 goggles
- Magnetic Fidlock® chin-strap technology and integrated GoPro® mount
- DOT- and ECE 22.05-approved

FIDLOCK



BLACK
XS-4XL
2861469

BLACK/RED
XS-4XL
2861472

RED/BLACK
XS-4XL
2861470

\$495⁹⁵

CARBON FIBER
BLACK/LIME
XS-4XL | 2861473

FOR
POLARIS

RED/BLACK
XS-4XL
2862467



TACTICAL

NEW TACTICAL 2.0 HELMET

BUILT FROM THE GROUND UP WITH INNOVATIVE FEATURES FOR ULTIMATE COMFORT AND CONTROL

SHELL **\$272⁹⁵**

- Shock-resistant, injection-molded thermoplastic

FEATURES

- Venturi vent system generates negative pressure at velocity and pulls moist air from the breath box
- Integrated eyepoint seal is co-integrated with the breath box and creates a draft-free seal with 509 goggles for unparalleled warmth and clear field of view
- Magnetic Fidlock® chin-strap technology
- DOT- and ECE 22.06-approved

FIDLOCK



MATTE BLACK
XS-4XL
2862468

GRAY
XS-4XL
2862469

LIME
XS-4XL
2862470

ORANGE
XS-4XL
2862471

GOGGLES



ORANGE
2862561



LIME
2862559

NEW 509 KINGPIN OFF-ROAD GOGGLE

PREMIUM MATERIALS, ATTRACTIVE PRICE **\$61⁹⁵**

FEATURES

- Oversized spherical lens delivers optimal peripheral vision
- Metal tear-off posts provide strength and durability
- Quick-change technology allows you to run the best lens tint for conditions



BLUE
2862562



STEALTH
2862560

NEW 509 MX6 OFF-ROAD GOGGLE

SUPER WIDE FIELD OF VIEW, ENGINEERED FOR DIRT **\$123⁹⁵**

FEATURES

- PC outer lens with anti-scratch coating, and internal anti-fog coating
- Outriggers with latch system for quick lens change
- 45mm strap with silicone to hold strap in place



BLACK
2862557



RED/BLACK
2862558

APPAREL

RIDING GEAR

HELMETS & GOGGLES

MEN'S APPAREL

WOMEN'S APPAREL

MERCHANDISE

MEN'S APPAREL

BLACK
S-3XL | 2862569



NAVY
S-3XL | 2862570



NEW
RED
S-3XL | 2862451



BLACK
S-3XL | 2861434

GRAY
S-3XL | 2861435

NEW WORK VEST

RUGGED AND DURABLE VEST THAT'S
IDEAL AS AN OUTDOOR LAYER

- Coated with Durable Water Repellency (DWR) to provide water-resistance
- 3M™ Thinsulate® for added warmth with brushed flannel trim
- Three outer pockets for storage

\$123⁹⁹

SOFTSHELL JACKET

VERSATILE LIGHTWEIGHT JACKET THAT'S SURPRISINGLY
WARM AND PERFECT FOR EVERYDAY WEAR

- Casual jacket armed with rugged and warm features for everyday wear
- Superior DWR prevents precipitation from saturating the jacket's exterior
- Lined with 280g of soft fleece for warmth
- Removable hood and underarm venting, three external pockets and one internal chest pocket

\$161⁹⁹



CHARCOAL
S-3XL | 2860865



BRONZE
S-3XL | 2860864



FOREST GREEN
S-3XL | 2860862



GRAY
S-3XL | 2860863



BLACK
S-3XL | 2861608

FLANNEL JACKET

SHERPA FLEECE LINED JACKET DELIVERS
EXCEPTIONAL WARMTH AND COMFORT

- Warm sherpa lined fleece material
- Insulation to keep you warm
- Plenty of storage for your valuables

\$123⁹⁹

WORK JACKET

WARM AND RUGGED JACKET THAT'S TOUGH
FOR WORK AND STYLISH FOR PLAY

- Coated with Durable Water Repellency (DWR) to provide water-resistance
- Built in action back for increased range of motion
- 80g 3M™ Thinsulate® for added warmth with brushed flannel trim
- One inner and four outer pockets for storage

\$198⁹⁹

NEW REVOLVE VEST

REVERSIBLE

DURABLE AND WARM REVERSIBLE VEST
OFFERS TWO STYLES IN ONE

- Durable windbreak outer fabric helps protect from the elements
- 140g 3M™ Thinsulate® insulation keeps you warm in cold weather
- Reversible vest offers two unique styles in one

\$123⁹⁹



BLUE/ORANGE
S-3XL | 2862566

BLACK/GRAY
S-3XL | 2862565



NEW WINDBREAKER JACKET

LIGHTWEIGHT, WINDPROOF JACKET THAT
PROVIDES PROTECTION WHILE RIDING

- 100% polyester windproof fabric
- Lightweight construction makes it easy to pack
- Three external pockets allow for maximum storage

\$132⁹⁹

Black | S-3XL | 2861541



FORCE JACKET

PACKABLE JACKET OFFERS LIGHTWEIGHT
PROTECTION, IDEAL FOR ANY ACTIVITY

- 140g 3M™ Thinsulate®
- Plenty of storage with two external hand pockets and one internal media pocket
- Rugged YKK® zippers
- Great for travel, compacts into pocket

\$173⁹⁹

Black | S-3XL | 2861432



NEW

TITAN MID-LAYER

EXTREMELY WARM YET BREATHABLE MID-LAYER, PERFECT FOR RIDING

- 319g Polartec® Thermal Pro® rib sweater provides great warmth
- Quick drying moisture wicking helps keep you dry
- Breathable material moves sweat to the outer surface
- Nylon overlay is comfortable and light

\$111.99

BLACK
S-3XL | 2862568

BLUE/ORANGE
S-3XL | 2862567



NEW
TAN
S-3XL | 2862450

NORTHSTAR MID-LAYER

VERSATILE MID-LAYER CAN BE WORN ALONE OR AS AN EXTRA LAYER

- 280g of breathable fleece for added warmth
- Offers durable protection against the elements with a wear-resistant polyester face and wind-block layer on chest
- Designed to fit under outer shell when riding

\$111.99

BLACK/RED
S-3XL | 2862616

BLACK/GRAY
S-3XL | 2869925



RED/BLACK
S-3XL | 2862490

NEW

JOURNEY HOODIE

DURABLE HOODIE DESIGNED FOR EVERY DAY WEAR

- Keeps the elements out with snug, rib-knit waist and cuffs
- Mock neck collar provides added protection and warmth
- Durable blended material made of 80% cotton, 20% polyester

\$86.99

BLACK
S-3XL | 2862489



TECH FULL-ZIP HOODIE

\$80.99

NEW Tan | S-3XL | 2862486
Gray | S-3XL | 2861493
Black/Blue | S-3XL | 2861494



CREW SWEATSHIRT

\$61.99

NEW Black | S-3XL | 2862488
Green | S-3XL | 2861498
Navy | S-3XL | 2861497



ICON HOODIE

\$68.99

NEW Gray | S-3XL | 2862487
Green | S-3XL | 2861495
Black | S-3XL | 2861496



ICON LONG SLEEVE

\$37.99

NEW Gray/Red | S-3XL | 2862505
Black | S-3XL | 2861584
Blue | S-3XL | 2861585



DASH LONG SLEEVE

\$37.99

NEW Gray | S-3XL | 2862504
Navy | S-3XL | 2861583
Black | S-3XL | 2861582



CHECKERED LONG SLEEVE

\$37.99

NEW Red | S-3XL | 2862506
Gray | S-3XL | 2861587
Black | S-3XL | 2861586



ICON TEE

\$30.99

NEW Green | S-3XL | 2862501
Black | S-3XL | 2861570
Blue | S-3XL | 2861571



STAMP TEE

\$30.99

NEW Black | S-3XL | 2862496
Gray | S-3XL | 2861565
Green | S-3XL | 2861564



CORE TEE

\$30.99

NEW Red | S-3XL | 2862502
Black | S-3XL | 2861572
Blue | S-3XL | 2861573

MEN'S CAMO

STEALTH CAMO HAT

\$32⁹⁹

Camo | One Size | 2861527

NORTHSTAR MID LAYER

\$119⁹⁹

Camo | S-3XL | 2861542

CAMO SOFTSHELL JACKET

\$172⁹⁹

Camo | S-3XL | 2861543



NEW

CAMO REVOLVE VEST

\$123⁹⁹

Camo | S-3XL | 2862572



NEW

PURSUIT HOODIE

\$61⁹⁹

Camo | S-3XL | 2862494



CAMO NECK GAITER

\$16⁹⁹

Camo | One Size | 2861948



CAMO TRUCKER HAT

\$32⁹⁹

Black | One Size | 2860613



HUNTER ORANGE HAT

\$30⁹⁹

Orange | S/M | 2860892
Orange | L/XL | 2862545



HUNTER ORANGE BEANIE

\$24⁹⁹

Orange | One Size | 2862595

MEN'S BALL CAPS



ELLIPSE PATCH TRUCKER HAT

\$32⁹⁹

NEW Light Gray | One Size | 2862539
Gray | One Size | 2861531
Black | One Size | 2861533
Navy | One Size | 2861532

NEW

HIGHLAND CAP

\$30⁹⁹

Tan | One Size | 2860893
Gray | One Size | 2862544



CORE CAP

\$32⁹⁹

NEW Gray | One Size | 2862594
Navy | One Size | 2861523
Black | One Size | 2861524



TONAL HAT

\$32⁹⁹

Black/Red | One Size | 2861526
Navy | One Size | 2861525



NEW

CLASSIC CAP

\$30⁹⁹

Gray | One Size | 2862543
Navy | One Size | 2862597



CHECKERED HAT

\$32⁹⁹

Blue | One Size | 2861520
Black | One Size | 2861522
Gray | One Size | 2861521



RETRO CAP

\$30⁹⁹

NEW Navy | One Size | 2862538
Gray/Red | One Size | 2869542
Gray/Orange | One Size | 2861536

APPAREL

RIDING GEAR

HELMETS & GOGGLES

MEN'S APPAREL

WOMEN'S APPAREL

MERCHANDISE

NEW
BLUE
S-3XL | 2862460



BLACK
S-3XL | 2862563



BLACK
S-3XL | 2861437

GRAY/BLUE
S-3XL | 2861439

BLUE
S-3XL | 2862564

SOFTSHELL JACKET

LIGHTWEIGHT PERFORMANCE THAT'S SURPRISINGLY WARM AND PERFECT FOR EVERYDAY WEAR

- Superior DWR prevents precipitation from saturating the jacket's exterior
- Lined with 280g of soft fleece for warmth
- Removable hood and underarm venting, three external pockets and one internal chest pocket

\$161⁹⁹

NEW WORK JACKET

WARM AND RUGGED JACKET THAT'S TOUGH FOR WORK AND STYLISH FOR PLAY

- Coated with DWR to provide water-resistance
- Built-in action back for increased range of motion
- 80g 3M™ Thinsulate® for added warmth with brushed flannel trim
- One inner and four outer pockets for storage

\$198⁹⁹



BLACK
S-3XL | 2862457

DUSTY ROSE
S-3XL | 2862456



BLACK
S-3XL | 2861433



BLACK/GRAY
S-3XL | 2862458

DUSTY ROSE
S-3XL | 2862459

NEW REVOLVE VEST

DURABLE AND WARM REVERSIBLE VEST OFFERS TWO STYLES IN ONE

- Durable windbreak outer fabric protects you from the elements
- 140g 3M™ Thinsulate® insulation keeps you warm in cold weather
- Reversible vest offers two unique styles in one

\$123⁹⁹

FORCE JACKET

PACKABLE JACKET OFFERS LIGHTWEIGHT PROTECTION, IDEAL FOR ANY ACTIVITY

- 140g 3M™ Thinsulate®
- Plenty of storage with two external hand pockets and one internal media pocket
- Rugged YKK® zippers
- Great for travel, compacts into pocket

\$173⁹⁹

NEW TITAN MID-LAYER

EXTREMELY WARM YET BREATHABLE MID-LAYER, PERFECT FOR RIDING

- 319g Polartec® Thermal Pro™ rib sweater provides great warmth
- Quick drying moisture wicking helps keep you dry
- Breathable material moves sweat to the outer surface
- Nylon overlay is comfortable and light

\$111⁹⁹



NEW
PURSUIT HOODIE
~~\$61⁹⁹~~
Camo | S-3XL | 2862517



NEW JOURNEY HOODIE

~~\$86⁹⁹~~
Black | S-3XL | 2862515
Blue | S-3XL | 2862516

TECH FULL-ZIP HOODIE

~~\$80⁹⁹~~
Maroon | S-3XL | 2861509
Gray | S-3XL | 2861508

ICON HOODIE

~~\$68⁹⁹~~
NEW White | S-3XL | 2862512
Black | S-3XL | 2861506
Maroon | S-3XL | 2861507



NEW ADVENTURE CREW

~~\$61⁹⁹~~
Dusty Rose | S-3XL | 2862513
Black | S-3XL | 2862514



NEW ADVENTURE TEE

~~\$30⁹⁹~~
Teal | S-3XL | 2862629
Black Frost | S-3XL | 2862628



THINK OUTSIDE TEE

~~\$30⁹⁹~~
NEW Pink | S-3XL | 2862518
Black | S-3XL | 2861590
Blue | S-3XL | 2861591

MERCHANDISE



STEEL SIGN
14" x 36" | 2860868
\$168⁹⁹



ALUMINUM SIGN
22" | 2860867
\$168⁹⁹



WOOD SIGN
10.5" x 24" | 2860866
\$97⁹⁹



PINT GLASSES (SET OF 2)
2860815 | \$25⁹⁹



12oz CAMPER MUG
2861612 | \$39⁹⁹



17oz WATER BOTTLE
2861611 | \$32⁹⁹



NEW
23oz WATER BOTTLE
2862685 | \$30⁹⁹



15oz CAMPFIRE MUG
2861613 | \$26⁹⁹



KEYCHAIN
2861614 | \$8⁹⁹



LEATHER LOOP KEYCHAIN
2861615 | \$19⁹⁹



NEW
LICENSE PLATE HOLDER
2862687 | \$24⁹⁹



NEW
KICKBACK ROCKER
2862626 | \$68⁰⁰



NEW
FREESTYLE ROCKER
2862625 | \$81⁰⁰



NEW
EASY CHAIR
2862627 | \$56⁰⁰



NEW
QUICK-E-SEAT
2862624 | \$43⁰⁰



NEW
FOLDING TABLE
2861620 | \$66⁹⁹



NEW
POLARIS PARKING SIGN
2869934 | \$24⁹⁹



NEW
POLARIS FLAG
3' x 5' | 2869928 | \$30⁹⁹



NEW
HITCH COVER
2861623 | \$43⁹⁹



APPAREL

RIDING GEAR

HELMETS & GOGGLES

MENS APPAREL

WOMENS APPAREL

MERCHANDISE

FORGE YOUR OWN PATH

GET THE BEST OWNER EXPERIENCE OUT THERE

Our goal is to make every day of ownership a smooth ride. Sign in for access to everything you need, plus exclusive offers and more.

[OFFROAD.POLARIS.COM/ACCOUNT](https://offroad.polaris.com/account)



MY GARAGE

- Vehicle Profile & Accessory Details
- Maintenance Schedules
- Schedule Service
- Manuals & Warranty Info



MY RIDES & COMMUNITY

- My Tracked Rides
- My Planned Routes & POIs
- My Community Activities & Events
- Explore Polaris Adventures



MY SHOPPING

- Recommended Accessories
- Purchase History
- My Dealer
- Access to Polaris Pros



CONNECT ONLINE
SEARCH "PolarisORV"



BUILD YOUR POLARIS SPORTSMAN

VISIT [POLARIS.COM/SPORTSMAN](https://polaris.com/sportsman)

TO SEE VEHICLE OPTIONS AND VIEW ACCESSORIES ON YOUR NEW MACHINE FROM EVERY ANGLE!

1 CHOOSE
MODEL

2 CHOOSE
TRIM

3 CHOOSE
COLOR

4 CHOOSE
ACCESSORIES



WARNING: POLARIS OFF-ROAD VEHICLES CAN BE HAZARDOUS TO OPERATE AND ARE NOT INTENDED FOR ON-ROAD USE. DRIVER MUST BE AT LEAST 16 YEARS OLD WITH A VALID DRIVER'S LICENSE TO OPERATE. ALL RIDERS SHOULD ALWAYS WEAR HELMETS, EYE PROTECTION AND PROTECTIVE CLOTHING AND FOOTWEAR. READ, UNDERSTAND AND FOLLOW YOUR OWNER'S MANUAL. RIDE WITHIN THE LIMITS OF YOUR OWN ABILITIES AND NEVER ENGAGE IN STUNT OR EXHIBITION DRIVING. NEVER RIDE UNDER THE INFLUENCE OF DRUGS OR ALCOHOL. ALL RIDERS SHOULD TAKE A SAFETY TRAINING COURSE. CALL 800-342-3764 FOR ADDITIONAL INFORMATION.

Unless noted, trademarks are the property of Polaris Industries Inc. 3M® and Thinsulate® are registered trademarks of 3M Company. 509® is a registered trademark of Teton Outfitters, LLC. App Store® is a registered trademark of Apple Inc. BatteryMinder® is a registered trademark of VDC Electronics Inc. Bluetooth® is a registered trademark of Bluetooth Sig, Inc. Caliber® is a registered trademark of Caliber, Inc. CAMSO® is a registered trademark of Artic Investments S.A. COOLCORE® is a registered trademark of COOLCORE LLC. Facebook® is a registered trademark of Facebook, Inc. Fidlock® is a registered trademark of Fidlock GmbH. Google Play® is a registered trademark of Google, Inc. Instagram® is a registered trademark of Instagram, LLC. Kolpin® is a registered trademark of Polaris Industries Inc. Polartec® is a registered trademark of MMI-IPCO, LLC. RIGID® is a trademark of JST Performance, LLC d/b/a Rigid Industries, LLC. Rockford Fosgate® is a registered trademark of Rockford Corporation. SMART BOARD® is a registered trademark of MART TECHNOLOGIES ULCLIMITED LIABILITY CORPORATION CANADA. TEKVEST® is a registered trademark of 1181676 ONTARIO INC. Tiger Drylac® is a registered trademark of TIGER COATINGS GMBH & CO. KG. Velcro® is a registered trademark of VELCRO BVDA. Twitter® is a registered trademark of Twitter, Inc. WALKER EVANS RACING® is a registered trademark of Walker Evans Enterprises Incorporated. Yeti® is a registered trademark of Yeti Coolers, LLC. YKK® is a registered trademark of YKK Corporation. YouTube® is a registered trademark of Google Inc. Prices, Fitment and Availability are subject to change at any moment. Copyright © 2021 Polaris Industries Inc. All rights reserved.

POLARIS

MY22 SPTSMN APP ACC CAN • 9948137