

CANADA VERSION

POLARIS *RANGER*

2022

ACCESSORIES + APPAREL



HARDEST WORKING.

SMOOTHEST RIDING.



For the past two decades, RANGER has set the standard through unrivaled strength, unmatched capability and next-level comfort, making it the number one utility side-by-side for over 10-years running.

2022 LINEUP

SEE THE FULL LINEUP AT [POLARIS.COM/RANGER](https://www.polaris.com/ranger)

2022 PACKAGES & LIMITED EDITIONS

P. 2

SEE P. 2-5 FOR DETAILS

XP 1000 & 1000 3-SEAT & CREW

P. 16



SP 570 / 500 MIDSIZE 2-SEAT & CREW

P. 68



570 FULL-SIZE 3-SEAT & CREW

P. 88

150 EFI YOUTH

P. 90



CONTENTS

2022 PACKAGES & LIMITED EDITIONS	2
XP 1000 & 1000 3-SEAT & CREW	16
ROOFS	18
WINDSHIELDS	20
REAR PANELS	22
DOORS	24
CAB COMFORT & CONVENIENCE	26
WINCHES	28
PROTECTION	30
AUDIO	32
STORAGE	36
COMMON ACCESSORIES	42
CONNECTED TECHNOLOGY	42
ELECTRICAL ACCESSORIES	44
COOLERS	46
HUNT	48
COLD WEATHER	50
PLOWS	52
LIGHTING	56
WHEELS & TIRES	58
SP 570 2-SEAT & CREW	68
ROOFS & DOORS	70
WINDSHIELDS & REAR PANELS	72
AUDIO & CONVENIENCE	74
PROTECTION & WINCHES	75
STORAGE	76
500/EV/570 2-SEAT & CREW	78
ROOFS & DOORS	80
WINDSHIELDS & REAR PANELS	82
CONVENIENCE & PROTECTION	84
WINCHES	85
STORAGE	86
570 FULL SIZE	88
150 EFI YOUTH	90
PARTS & GARAGE	92
MAINTENANCE	92
OIL & LUBRICANTS	94
MAINTENANCE FLUIDS	96
BATTERIES & GARAGE ACCESSORIES	98
HD PARTS	100
SERVICE PARTS	102
TIRE SEALANT & TRAILERING	104
POLARIS POWER	106
APPAREL	112
RIDING GEAR	112
HELMETS & GOGGLES	114
MEN'S APPAREL	116
WOMEN'S APPAREL	122
MERCHANDISE	124

RANGER XP 1000 & SP 570 NORTHSTAR OFF-ROAD CLIMATE CONTROL

Be in control of your comfort with standard Pro Shield Cab System, heat, air conditioning (RANGER XP 1000 models), and more. Polaris RANGER NorthStar Editions help you finish whatever task you set out to do, no matter the weather conditions. Take your NorthStar to the next level with hundreds of accessories to choose from based on your riding needs.



DO MORE:

PROTECTION

Protect the front and rear of your RANGER from whatever obstacles you may encounter off-road.

XP 1000 P. 30
SP 570 P. 75

AUDIO

Customize your audio system to listen to your favorite songs on the trails.

XP 1000 P. 32
SP 570 P. 74

LIGHTING

Extend the day and work longer with easy-to-install powerful lighting.

P. 56

WHEELS & TIRES

Select wheels and tires custom built for your riding style and the terrain you ride in.

P. 58

STORAGE

Leave nothing behind with the limitless customization of Lock & Ride storage.

XP 1000 P. 36
SP 570 P. 76

UPGRADE YOUR NORTHSTAR XP 1000 & SP 570 FAMILIES

You've got the essentials straight from the factory—but why stop there? Get the most out of your NorthStar with additional Polaris Engineered accessories to fit your riding needs. Add the MUST HAVES for top-selling accessories or UTILITY to optimize for the toughest outdoor jobs. Or, pick and choose your favorite accessories to make it your own.



NORTHSTAR ULTIMATE COMES STANDARD WITH:

Heating & Air Conditioning HVAC System
7" Display Powered by RIDE COMMAND
Pro Shield Full Glass Tip-Out Windshield with Wiper/Washer System
Power Window Doors
Polaris HD 4,500 lb. Winch with Auto-Stop
Sport Roof with Premium Liner & Dome Light
Lock & Ride Glass Panel
LED Headlights
29" Tires



NORTHSTAR PREMIUM COMES STANDARD WITH:

Heating & Air Conditioning HVAC System
Polaris HD 4,500 lb. Winch with Auto-Stop
Sport Roof with Premium Liner & Dome Light
Lock & Ride Glass Windshield with Wiper/Washer System
Lock & Ride Glass Rear Panel
Premium Manual Crank Window Doors



RANGER SP 570 NORTHSTAR COMES STANDARD WITH:

Heating & Ventilation System
Polaris HD 3,500 lb. Winch with Auto-Stop
Sport Roof with Premium Liner
Lock & Ride Glass Windshield
Lock & Ride Glass Rear Panel
Premium Manual Crank Window Doors

	PRODUCT NAME	XP 1000	PRICE	PAGE	SP 570	PRICE	PAGE
MUST HAVES	Upper Front Brushguard	2882531	\$339 ⁹⁹	P. 30	2885084	\$339 ⁹⁹	P. 75
	Rear Brushguard	2882529	\$329 ⁹⁹	P. 30	2885087	\$299 ⁹⁹	P. 75
	Front Hood Storage Rack	2882690	\$469 ⁹⁹	P. 38	2885088	\$479 ⁹⁹	P. 77
	Lock & Ride Storage Box	2883279	\$439 ⁹⁹	P. 41	2889199	\$439 ⁹⁹	P. 76
	Polaris PULSE Wiring Harness - 1 Light Bar	2883230	\$119 ⁹⁹	P. 45	2889161	\$119 ⁹⁹	P. 45
	Pro Armor 33" - Combo LED Light Bar	2882077	\$509 ⁹⁹	P. 57	2882077	\$509 ⁹⁹	P. 57
			\$2,209 ⁹⁴			\$2,189 ⁹⁴	
UTILITY	Side View Mirrors - Door Mounted	2889241	\$219 ⁹⁹	P. 27	2889241	\$219 ⁹⁹	P. 74
	Lock & Ride Bed Extender/Divider	2882752	\$329 ⁹⁹	P. 38	2889183	\$324 ⁹⁹	P. 76
	Electronic Cargo Box Lift	2884141	\$799 ⁹⁹	P. 40	N/A	N/A	N/A
			PLUS \$1,349 ⁹⁷			PLUS \$544 ⁹⁸	

TAKE ADVANTAGE
of your off-road climate control with winter and plow accessories on P. 52



TAKE YOUR
2022 RANGER
SPECIAL EDITION
 TO THE NEXT LEVEL



You've already elevated your off-road experience with an industry-exclusive package. Don't stop there! Customize your experience by adding key accessories.

TRAIL BOSS
 RANGER XP 1000 / NORTHSTAR

**RECOMMENDED
 ADD-ONS**

- PROTECTION P. 30
- STORAGE P. 36
- LIGHTING P. 56
- WHEELS & TIRES P. 58



TEXAS EDITION
 RANGER XP 1000

**RECOMMENDED
 ADD-ONS**

- WINDSHIELDS P. 20
- PROTECTION P. 30
- STORAGE P. 36
- LIGHTING P. 56



HIGH LIFTER
 RANGER XP 1000

**RECOMMENDED
 ADD-ONS**

- ROOFS P. 18
- AUDIO P. 32
- COOLERS P. 46
- LIGHTING P. 56



DESIGNED



Designed by the same people who designed your vehicle.

TESTED



Extensively tested in the field so you ride with 100% confidence.

TRUSTED



ACCESSORIES
BACKED BY A



WARRANTY

65 years in the business.
The #1 name in Off-Road.

INTRODUCING OUR NEWEST PARTNER



Introducing an industry exclusive – Rhino-Rack® storage solutions designed specifically for Polaris RANGER. From opposite sides of the globe, the most capable machines in the off-road world meet a trusted outdoor adventure brand to deliver industry-exclusive, purpose-built roof racks, bed racks and accessories to help Polaris RANGER users have more fun and get more done. Designed for perfect integration and tested to off-road standards, a Rhino-Rack®-equipped RANGER will help you get more storage capacity out of your machine – so you can stay prepared for whatever they day may bring.



WE HOLD OUR PARTNERS TO THE SAME STANDARDS



WHEELS, TIRES & LIGHTING DESIGNED WITH POLARIS TO MAXIMIZE PERFORMANCE
P. 56 & 58



IGNITE AND FUEL YOUR PASSION FOR PRECISE QUALITY SOUND REPRODUCTION
P. 34



PRODUCTS SO GOOD THEY REPLACE OR REPAIR THEM FOR LIFE
P. 56



DARE TO LISTEN
P. 74



MAKING PRODUCTS FOR AVID SPORTSMEN SINCE 1943
P. 48



DIGITAL GAUGES FOR POWERSPORTS RIDERS
P. 43



BRING IT ALL. BRING IT ON.
P. 36



INTRODUCING THE NEW INDUSTRY-EXCLUSIVE
RHINO-RACK® STORAGE SOLUTIONS

BRING IT ALL.
BRING IT ON.

SEE RHINO-RACK® PRODUCTS ON P. 36



INTRODUCING THE NEW
RANGER SP 570

GET MORE DONE.
HAVE MORE FUN.



NEXT-LEVEL COMFORT

LEVERAGE THE FULL
CAPABILITIES OF YOUR
MACHINE YEAR-ROUND.

RANGER

PRO SHIELD
CAB SYSTEM



SUPERIOR INTEGRATION

MAKE WORK EASIER WITH YOUR
VEHICLE BUILT TO ADD ESSENTIAL
ACCESSORIES FOR ANY JOB.

PRO PRO HEAVY DUTY SERIES

WINCHES

GLACIER

PLOW SYSTEM

POLARIS
PULSE
Electrical System



DO MORE

TACKLE ANY JOB AND
LEAVE NOTHING BEHIND.

LOCK & RIDE

RHINO-RACK



ENGINEERED FOR MORE



HARDEST WORKING, SMOOTHEST RIDING.

RANGER is a trusted, most capable, work partner. Developed and tested along with the vehicle, Polaris Engineered Accessories are designed for seamless integration and simple installation to get more done, year-round.

SUPERIOR INTEGRATION

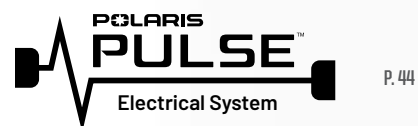

PLUG AND PLAY ELECTRICAL

A revolution in electrical accessory integration, the Polaris PULSE Electrical System allows for a simple plug and play approach for adding power to Polaris Engineered Accessories.

PRO PRO HEAVY DUTY SERIES

WINCHES

RANGER XP 1000/1000 P.28
RANGER SP 570 P.75

INTEGRATED WINCH MOUNT & PRE-WIRED

Designated mounting points and pre-wired connectors ensure a perfect fit and the strongest place to attach the Polaris Engineered winch - the most dependable winch for your RANGER. With wiring built right into the vehicle, we made this the easiest RANGER winch ever to install.



PLOW SYSTEM

INTEGRATED PLOW MOUNT*

The attachment points for the Glacier Plow System are integrated right at the factory and feature an innovative drive-up and go installation process.

*Integrated Plow Mount not included on RANGER SP 570 Non-Premium/Non-NorthStar Models



DO MORE

LOCK & RIDE™

CARGO BOX VERSATILITY

Lock & Ride mounting locations allow for limitless customization to let you work the way you want.

RANGER XP 1000/1000 P.38
RANGER SP 570 P.76

BRING IT ALL. BRING IT ON.



STORAGE VERSATILITY

Rhino-Rack® roof rack and bed rack solutions offer 40% more storage capacity so you never have to leave tools or gear behind.

RANGER XP 1000/1000 P.36

NEXT-LEVEL COMFORT

OUR BEST SEALING CAB

With the profile channels engineered into the roll cage, body plastics molded to seal and cab accessories designed to keep the elements out, the RANGER Pro Shield Cab System offers a new level of interior comfort.



RANGER XP 1000/1000 P.18
RANGER SP 570 P.70



NEXT-LEVEL COMFORT

Look for the RANGER PRO SHIELD Logo for the four components to customize your RANGER with our best sealing cab.

BUILD YOUR CAB SYSTEM

1 CHOOSE YOUR ROOF
RANGER XP 1000 P.18
RANGER SP 570 P.70

2 CHOOSE YOUR WINDSHIELD
RANGER XP 1000 P.20
RANGER SP 570 P.72

3 CHOOSE YOUR REAR PANEL
RANGER XP 1000 P.22
RANGER SP 570 P.73

4 CHOOSE YOUR DOORS
RANGER XP 1000 P.24
RANGER SP 570 P.71



- ULTIMATE CLARITY**
Tempered safety glass, clear to see through and shatterproof.
- COLOR MATCHED**
Key color matched accent panels available.
- PROTECTION**
Inner and outer shells are made from high-quality, injection-molded plastics using a state-of-the-art process to shield from the elements and more.
- DURABLE CONSTRUCTION**
With a 2.5 cm tube steel frame, these doors can handle the rigors of the off-road.



A FRAME DESIGNED FOR A CAB

All RANGER cab components fit perfectly to the contours of the profile tube cab frame, floor and body panels, allowing for a 360° gasket seal, seamless fit and installation providing unprecedented protection from the elements.

INCREASED RIDER COMFORT

Add a new level of interior comfort by adding a RANGER Pro Shield Cab System - tested to military standards. Seal out dust, water, and noise by selecting a roof, windshield, rear panel, and set of doors. Extend your work day or trail ride while protecting you and your passengers from the elements.

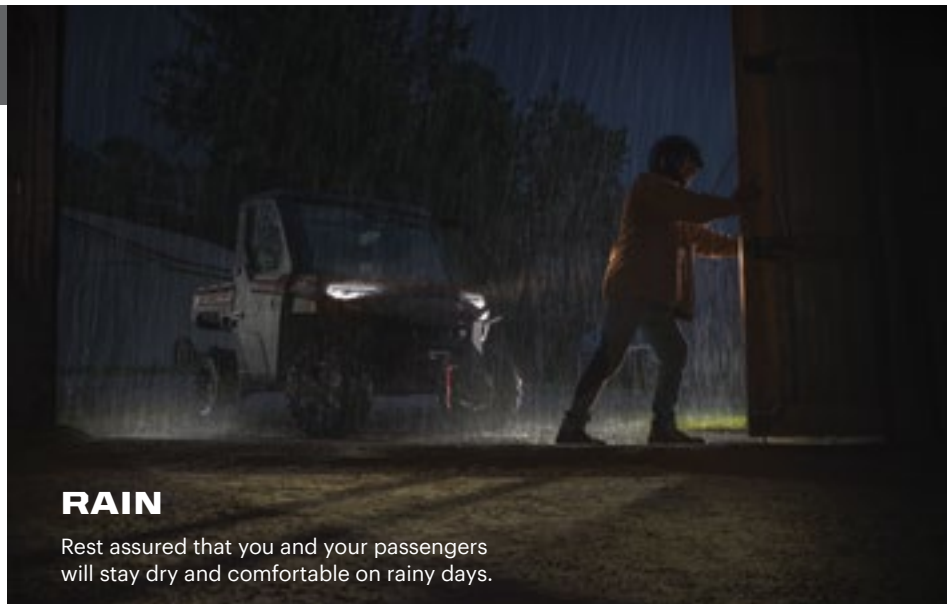

RAIN

Rest assured that you and your passengers will stay dry and comfortable on rainy days.



SNOW

Keep cold wind and snow out in winter months.

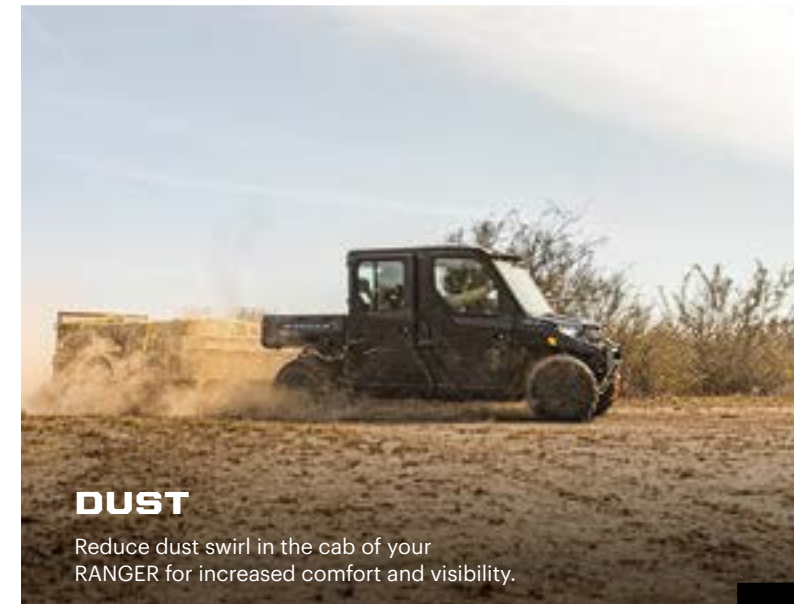

DUST

Reduce dust swirl in the cab of your RANGER for increased comfort and visibility.

SUPERIOR INTEGRATION

PRO PRO HEAVY DUTY SERIES

HD HEAVY DUTY SERIES



RANGER XP 1000/1000 P.28
RANGER SP 570 P.75

POLARIS ENGINEERED WINCH FEATURES



Tested **1,200+** pulls at max load, it works when you need it to



Built to withstand **-20° F** temperatures

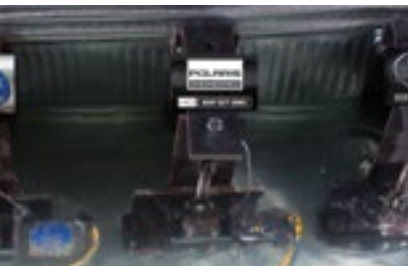

Sealed motor & heavy duty gears
OPERATE FULLY SUBMERGED UNDERWATER



MILITARY tested & approved

Right from the factory, your vehicle is built to make essential accessories like winches and plows easy to use day-in and day-out. Mounting brackets are designed into the oversized factory bumper and wiring is routed securely and properly. When it comes to RANGER, Polaris Engineered Accessories make work easier so you can get more done.

POLARIS
ENGINEERED

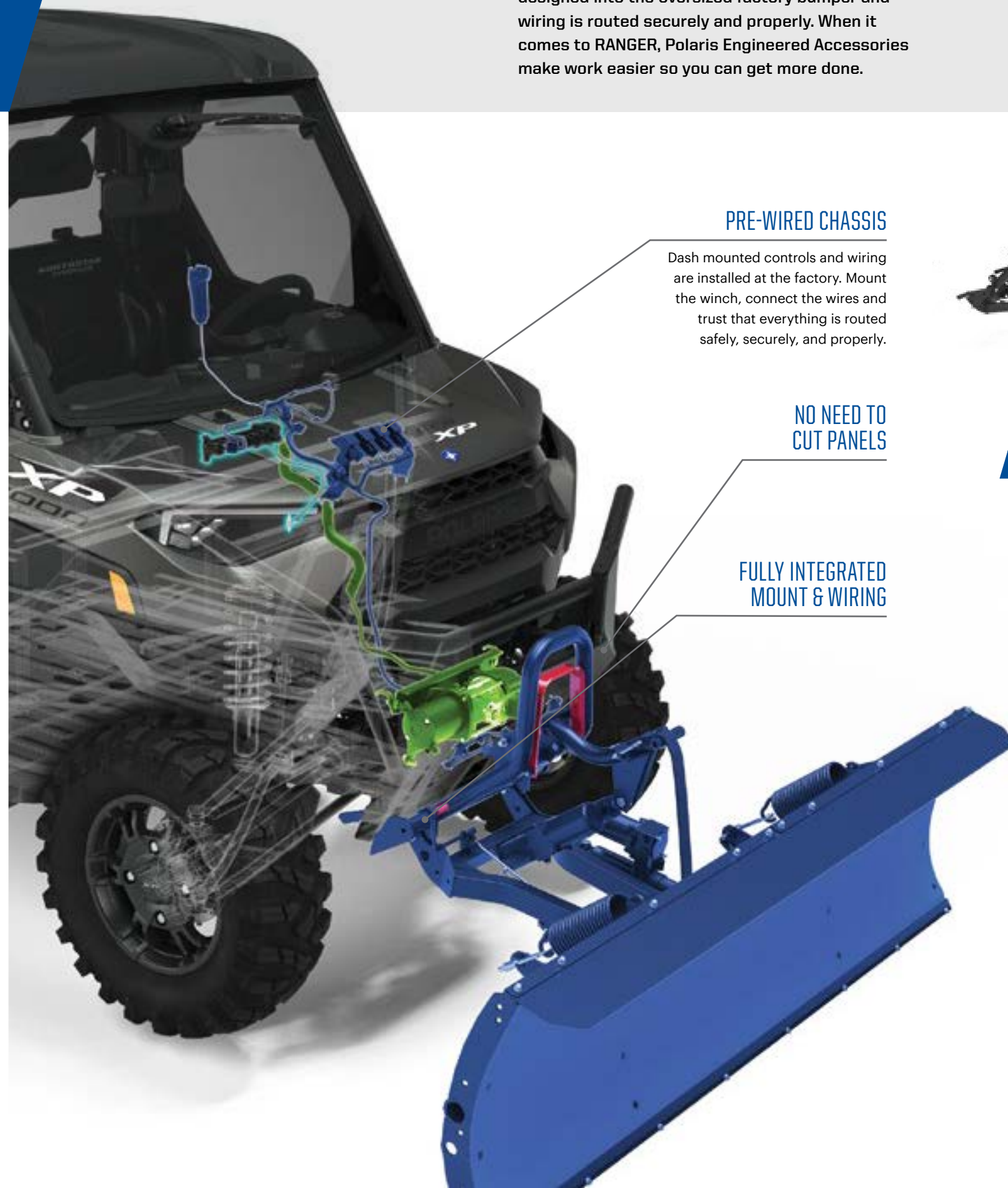

PRE-WIRED CHASSIS

Dash mounted controls and wiring are installed at the factory. Mount the winch, connect the wires and trust that everything is routed safely, securely, and properly.

NO NEED TO CUT PANELS

FULLY INTEGRATED MOUNT & WIRING

GLACIER PLOW SYSTEM

P.52



GLACIER FEATURES



To install the plow, simply lift the mount lock handle and pull forward



No loss of factory ground clearance when not plowing



Don't have to crawl under the machine to release the plow blade from the vehicle



No trimming of vehicle plastic or fascia required to mount plow or winch

Angle your blade right from your seat

25°

LEFT AND RIGHT



MAKE IT YOURS

WORK HARD AND GET IT DONE

with Polaris Engineered Accessories for your RANGER. Start with the ultimate in all-season performance and comfort with the best cab components in the industry. Find everything you need to outfit your RANGER for the task at hand.

RANGER XP 1000 /
RANGER 1000

RANCH

2882910	Dual Bin Under Seat Dry Storage Box	P. 26	2882529	Rear Brushguard	P. 30
2882753	8-Vent Heater & Defrost System	P. 26	2882752	LOCK & RIDE Bed Extender/Divider	P. 38
2883265	Work Beacon LED Light	P. 27	2881531	LOCK & RIDE Tip-Down Headache Rack	P. 38
2882710	Polaris Pro HD 6,000 Lb. Winch with Rapid Rope Recovery	P. 29	2883121	Rigid® SR-Series 10" Spot LED Light	P. 56
2882531	Upper Front Brushguard	P. 30	2883148	Pro Armor Wheel & Tire Set: Dual Threat & 4202	P. 65



RANGER XP 1000 /
RANGER 1000

BIG GAME

2882753	8-Vent Heater & Defrost System	P. 26	2884107	LOCK & RIDE Kolpin Rhino Grip Pro	P. 49
2883265	Work Beacon LED Light	P. 27	2882077	Pro Armor 33" - Combo LED Light Bar	P. 57
2882710	Polaris Pro HD 6,000 Lb. Winch with Rapid Rope Recovery	P. 29	2883157	Pro Armor Wheel & Tire Set: Attack 2.0 & 5202	P. 64
2882690	Front Hood Storage Rack	P. 38			



RANGER XP 1000 /
RANGER 1000

WATERFOWL

2883265	Work Beacon LED Light	P. 27	2883263	In-Cab Gun Mount	P. 49
2882711	Polaris Pro HD 4,500 Lb. Winch with Rapid Rope Recovery	P. 29	2882076	Pro Armor 2"x2" Cube - LED Spot Light (x2)	P. 56
2882690	Front Hood Storage Rack	P. 38	2884271	Pro Armor Wheel & Tire Set: Mud XC & 4204	P. 64
2882177	LOCK & RIDE CargoMax System	P. 38			



RANGER XP 1000 /
RANGER 1000

CRAFTSMAN

2882711	Polaris Pro HD 4,500 Lb. Winch with Rapid Rope Recovery	P. 29	2881533	LOCK & RIDE Tool Rack	P. 41
2882752	LOCK & RIDE Bed Extender/Divider	P. 38	2882077	Pro Armor 33" - Combo LED Light Bar	P. 57
2882751	Cargo Bed Mat	P. 40	2882384	Wheel & Tire Set: Pro Armor Harvester & 4202	P. 64
2879354	LOCK & RIDE Chainsaw Mount	P. 40			
2883279	LOCK & RIDE Storage Box	P. 41			

SHOP ALL RANGER ACCESSORIES AT
[POLARIS.COM/ShopRANGER](https://www.polaris.com/ShopRANGER)

COMPLETE LIGHTING WITH REQUIRED
LIGHT BAR HARNESSES

SEE P. 56

ROOFS

POLY FEATURES

- Water run-off
- Polaris PULSE plug and play
- Liner ready
- Lightweight

TO SHIELD AGAINST DRIVING RAIN OR THE BLISTERING SUN, a roof is the first must-have of the Polaris Engineered cab components. Choose from poly or steel, and get on your way with protective peace of mind.

POLY

Lightweight, durable and impact-resistant. A poly roof can take the abuse of a tough trail and still protect.

LINERS

Get a touch of premium comfort, reduce cab noise and hide wiring. **Included with Premium Poly Roofs.**

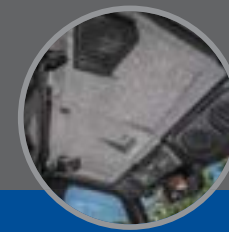

PREMIUM FINISH AND QUIETER RIDE

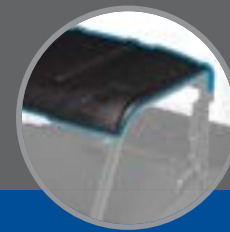

SEALED COVERAGE

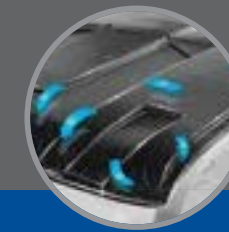

REDUCE STANDING WATER



EASY AND FAST INSTALLATION

POLARIS ENGINEERED ADVANTAGES

PREMIUM & SPORT ROOF FEATURES

SEE AUDIO OPTIONS P.32



* PREMIUM AND SPORT FEATURES NOT AVAILABLE ON STEEL ROOFS

MULTI-FUNCTION LIGHT READY

WINDSHIELD WIPER & WASHER SYSTEM WIRING READY

POLARIS PULSE INTEGRATION

AUDIO READY

SOUND ABSORBING LINER

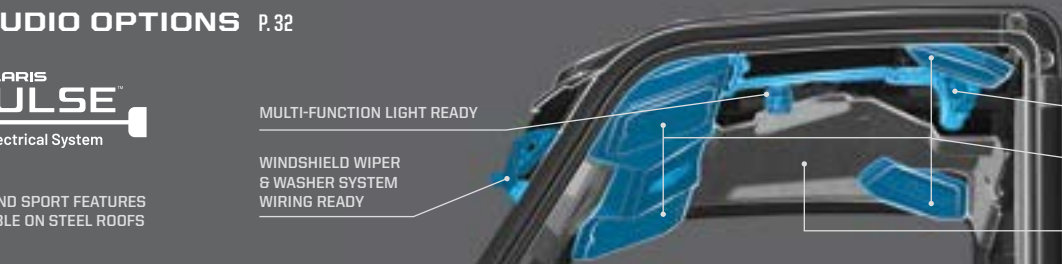

PREMIUM ROOF - POLY

» POLARIS PURSUIT CAMO • 2882913 • \$929⁹⁹

» **TOP SELLER** BLACK • 2882912 • \$734⁹⁹

XP 1000 '17-22, 1000 '20-22

INCLUDES ROOF LINER



SPORT ROOF - POLY **TOP SELLER**

» BLACK • 2882911 • \$454⁹⁹

XP 1000 '17-22, 1000 '20-22



PREMIUM ROOF LINER

» 2882914 • \$269⁹⁹

XP 1000 '17-22, 1000 '20-22

WORKS WITH 2882911, 2882912, 2882913



PREMIUM ROOF CREW - POLY

» POLARIS PURSUIT CAMO • 2883277 • \$1,599⁹⁹

CREW XP 1000 '19-22, CREW 1000 '20-22
ROOF LINER INCLUDED WITH CAMO



SPORT ROOF CREW - POLY **TOP SELLER**

» BLACK • 2883274 • \$709⁹⁹

CREW XP 1000 '19-22, CREW 1000 '20-22



PREMIUM ROOF LINER - CREW **TOP SELLER**

» 2883457 • \$339⁹⁹

CREW XP 1000 '18-22, CREW 1000 '20-22



PLUG AND PLAY

ADD POWER TO PREMIUM & SPORT ROOFS P.44

WINDSHIELDS

GLASS VS POLY

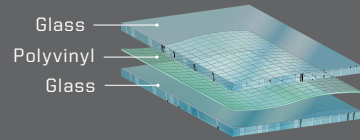

- Superior optical clarity (automotive level)
- Scratch-resistant
- Curved to fit, seals tight
- Cold weather / heavy duty
- Wiper ready

VS

POLY

- Lightweight, flexible, easy to store/remove
- Impact-resistant
- 360° seal keeps out rain and dust

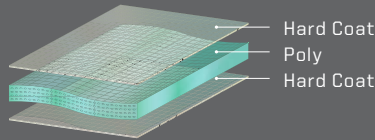

TIP-OUT FULL WINDSHIELD - GLASS

- Tip-out design offers three positions: open, closed and vented
 - Gas shocks assist in easy opening and closing
 - 360° gasket for reliable protection and comfort
 - Scratch-resistant automotive-style curved glass
- » 2889020 • \$1,614⁹⁹
XP 1000 '18-22, CREW XP 1000 '19-22, CREW 1000 '20-22, 1000 '20-22



FULL GLASS WINDSHIELD - CLEAR

- Scratch-resistant, curved laminate safety glass
 - Protects against wind, rain and other debris
 - UV-blocking interlayer and 360° gasket seal
- » 2889021 • \$949⁹⁹
XP 1000 '18-22, CREW XP 1000 '19-22, CREW 1000 '20-22, 1000 '20-22



LOCK & RIDE
EASY AND FAST
INSTALLATION



**AIRTIGHT
GASKET SEAL**



**MULTI-FUNCTION
FEATURES**

POLARIS ENGINEERED ADVANTAGES

HARD COAT POLY | 30x MORE SCRATCH-RESISTANT



LOCK & RIDE FULL WINDSHIELD VENTED - HARD COAT POLY TOP SELLER

- Frameless design for maximum visibility
 - Added vents for airflow on a hot day or defrosting on a cold day
 - Requires Wiper Install Kit, 2207624
- » 2883266 • \$779⁹⁹
XP 1000 '17-22, CREW XP 1000 '18-22, CREW 1000 '20-22, 1000 '20-22



LOCK & RIDE FULL WINDSHIELD - HARD COAT POLY TOP SELLER

- Frameless design for maximum visibility
 - Requires Wiper Install Kit, 2207624
- » 2883300 • \$669⁹⁹
XP 1000 '17-22, CREW XP 1000 '18-22, CREW 1000 '20-22, 1000 '20-22



FLIP-DOWN WINDSHIELD - HARD COAT POLY TOP SELLER

- Two venting options: fully sealed, flip-down or remove upper half for some protection with maximum ventilation
- » 2884139 • \$739⁹⁹
XP 1000 '18-22, CREW XP 1000 '19-22, CREW 1000 '20-22, 1000 '20-22



LOCK & RIDE FULL WINDSHIELD - POLY TOP SELLER

- Frameless design for maximum visibility
- » 2883278 • \$539⁹⁹
XP 1000 '17-22, CREW XP 1000 '18-22, CREW 1000 '20-22, 1000 '20-22



LOCK & RIDE HALF WINDSHIELD - POLY TOP SELLER

- Deflects air flow from straight on, but still provides air flow in the cab
- » 2883301 • \$269⁹⁹
XP 1000 '17-22, CREW XP 1000 '18-22, CREW 1000 '20-22, 1000 '20-22



ADD ALL-WEATHER VISIBILITY
WINDSHIELD WIPER
& WASHER SYSTEM
P. 26

HARD COAT POLY WINDSHIELD WIPER & WASHER MOUNTING BRACKET

- Required to use wiper on 2883266 or 2883300
- » 2207624 • \$74⁹⁹
XP 1000 '17-22, CREW XP 1000 '18-22, CREW 1000 '20-22, 1000 '20-22



REDUCE IN-CAB DUST
SWIRL BY ADDING A
REAR PANEL
SEE P. 22

REAR PANELS

GLASS

VS

POLY

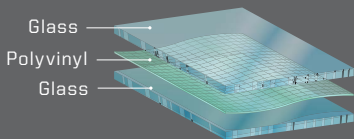

- Superior optical clarity (automotive level)
- Scratch-resistant
- Curved to fit, seals tight
- Cold weather / heavy duty
- Wiper ready (windshield only)

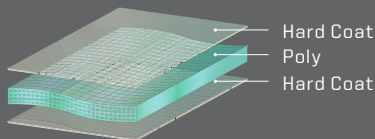

- Lightweight, flexible, easy to store/remove
- Impact-resistant
- Tight seal keeps out rain and dust

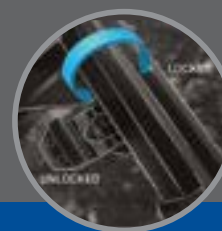

LOCK & RIDE
EASY AND FAST
INSTALLATION



**AIRTIGHT
GASKET SEAL**



**VENTING
OPTIONS**

POLARIS ENGINEERED ADVANTAGES



**REDUCE IN-CAB DUST SWIRL
BY ADDING A REAR PANEL**
With a windshield and roof installed, turbulent air develops behind the cab. Add a rear panel to reduce dust intrusion from this swirl.

HARD COAT POLY | 30x MORE SCRATCH-RESISTANT



LOCK & RIDE
REAR PANEL - SLIDING GLASS

- Sliding window provides ventilation, cab comfort and access to cargo in rear box
- » 2879015 • \$929⁹⁹

XP 1000 '17-22, CREW XP 1000 '18-22, CREW 1000 '20-22, 1000 '20-22



LOCK & RIDE
REAR PANEL - GLASS TOP SELLER

- » 2879013 • \$519⁹⁹

XP 1000 '17-22, CREW XP 1000 '18-22, CREW 1000 '20-22, 1000 '20-22



LOCK & RIDE
REAR PANEL - POLY POLARIS PURSUIT CAMO

- Strong, thick polycarbonate provides outstanding impact and scratch resistance
- Installs in contours of cab frame with 360° gasketing for outstanding protection, comfort, fit and finish
- Dot matrix screen printing allows for rear visibility
- » 2883774 • \$539⁹⁹

XP 1000 '17-22, CREW XP 1000 '18-22, CREW 1000 '20-22, 1000 '20-22



LOCK & RIDE
REAR PANEL - POLY - CLEAR TOP SELLER

- Strong, thick polycarbonate provides outstanding impact and scratch resistance
- Installs in contours of cab frame with 360° gasketing for outstanding protection, comfort, fit and finish
- » 2883773 • \$469⁹⁹

XP 1000 '17-22, CREW XP 1000 '18-22, CREW 1000 '20-22, 1000 '20-22

DOORS

THE BEST CAB

COMPLETED



SEE WHAT PEOPLE ARE SAYING ABOUT THESE DOORS
[YOUTUBE.COM/POLARISORV](https://www.youtube.com/polarisorv)
 SEARCH "DOORS"

KEY FEATURES

RANGER PRO SHIELD CAB SYSTEM

WINDOW TYPE / VENTILATION

VISIBILITY

STORAGE COMPARTMENT

AUDIO-READY / SPEAKER MOUNT

PREMIUM TPE LINER

SPECIAL FEATURES

	PREMIUM POLY DOORS			POLY DOORS		CANVAS DOORS
	POWER WINDOW DOORS	MANUAL CRANK WINDOW DOORS	HALF DOORS	RANGER HUNTER DOORS	RANGER CLEARVIEW DOORS	ZIP WINDOW DOORS
	GLASS / POWER	GLASS / MANUAL CRANK	NA / OPEN TOP	GLASS / HINGED	GLASS / HINGED	CLEAR POLY / ZIPPED
	UPPER	UPPER	UPPER	UPPER	UPPER + LOWER	UPPER + PARTIAL LOWER
	STANDARD	STANDARD	STANDARD			
	STANDARD, PRE-WIRED	STANDARD				
	STANDARD	STANDARD	STANDARD			
	BUILT-IN FLOOR LIGHT, COLORED ACCENT PANELS AVAILABLE	COLORED ACCENT PANELS AVAILABLE	COLORED ACCENT PANELS AVAILABLE	DURABLE POLY CONSTRUCTION, POLARIS PURSUIT CAMO	DURABLE POLY CONSTRUCTION	AVAILABLE IN POLARIS PURSUIT CAMO
	<ul style="list-style-type: none"> The ultimate door offering power windows, switches mounted on the door and built-in floor light. 	<ul style="list-style-type: none"> A premium, door offering manual crank windows for airflow adjustment in the cab. 	<ul style="list-style-type: none"> Provides lower protection from the off-road with an open-air experience. 	<ul style="list-style-type: none"> Tough clear poly shell extends from the bottom of the door until it meets the upper-hinged glass window. Premium Polaris Pursuit Camo pattern offers extensive camo coverage. 	<ul style="list-style-type: none"> Deliver nearly uninterrupted visibility and maximum ambient lighting inside the cab. Tough clear poly shell extends from the bottom of the door until it meets the upper-hinged glass window. 	<ul style="list-style-type: none"> Lightweight, durable protection with adjustable zipper ventilation and see-through bottom panel.

Front and Rear Doors are required to complete a cab on CREW RANGER models.

Premium Doors come with Gloss Black Exterior Door Accent Panels, images shown with optional Exterior Door Accent Panels.

FRONT DOORS (SET OF 2) XP 1000 '18-'22, CREW XP 1000 '19-'22, CREW 1000 '20-'22, 1000 '20-'22	 TOP SELLER Power Window Doors - Poly - Black 2884338 • \$4,219 ⁹⁹	 TOP SELLER Manual Crank Window Doors - Poly - Black 2882561 • \$3,419 ⁹⁹	 Half Doors - Poly 2882559 • \$2,039 ⁹⁹	 RANGER Hunter Doors - Polaris Pursuit Camo 2883229 • \$2,999 ⁹⁹	 RANGER ClearView Doors 2882901 • \$2,709 ⁹⁹	 TOP SELLER Zip Window Doors - Canvas - Polaris Pursuit Camo 2882903 • \$1,639 ⁹⁹
	 TOP SELLER Manual Crank Window Doors - Rear - Poly 2883437 • \$3,419 ⁹⁹	 Half Doors - Rear - Poly 2883438 • \$2,039 ⁹⁹	 RANGER Hunter Doors - Rear - Polaris Pursuit Camo 2883633 • \$3,009 ⁹⁹	 RANGER ClearView Doors - Rear 2883632 • \$2,709 ⁹⁹	 Zip Window Doors - Rear - Canvas - Black 2883634 • \$1,229 ⁹⁹	

EXTERIOR DOOR ACCENT PANELS // Replace stock gloss black accent panels // Painted plastic and clear-coated for UV protection // Install easily with a single screw // Comes as a pair

FRONT REAR	 Solar Red 2883499-342 • \$65 ⁹⁹	 Sunset Red Metallic 2882870-520 • \$65 ⁹⁹ 2883829-520 • \$65 ⁹⁹	 Sand Metallic 2882870-555 • \$65 ⁹⁹ 2883829-555 • \$65 ⁹⁹	 Sage Green 2883843-560 • \$65 ⁹⁹	 Pearl White 2882870-566 • \$65 ⁹⁹ 2883829-566 • \$55 ⁹⁹	 Suede Metallic 2882870-577 • \$65 ⁹⁹	 Polaris Pursuit Camo 2882870-587 • \$129 ⁹⁹ 2883829-587 • \$129 ⁹⁹	 Magnetic Gray 2882870-603 • \$65 ⁹⁹	 Burgundy Metallic 2882870-629 • \$65 ⁹⁹ 2883829-629 • \$65 ⁹⁹
FRONT REAR	 Matte Titanium 2882870-632 • \$65 ⁹⁹ 2883829-632 • \$65 ⁹⁹	 Black Pearl 2882870-666 • \$65 ⁹⁹ 2883829-666 • \$65 ⁹⁹	 Matte Sunset Red 2882870-669 • \$54 ⁹⁹	 Matte Sagebrush Green 2882870-685 • \$65 ⁹⁹ 2883829-685 • \$65 ⁹⁹	 Military Tan 2882870-686 • \$65 ⁹⁹	 Matte Navy 2882870-726 • \$65 ⁹⁹ 2883829-726 • \$65 ⁹⁹	 Orange Rust 2882870-750 • \$65 ⁹⁹	 Maroon Metallic 2882870-754 • \$65 ⁹⁹ 2883829-754 • \$65 ⁹⁹	 Black Cherry 2882870-756 • \$65 ⁹⁹ 2883829-756 • \$65 ⁹⁹
FRONT REAR	 Steel Blue 2882870-765 • \$65 ⁹⁹ 2883829-765 • \$65 ⁹⁹	 Ghost White Metallic 2882870-774 • \$65 ⁹⁹ 2883829-774 • \$65 ⁹⁹	 Polaris Blue 2882870-795 • \$76 ⁹⁹ 2883829-795 • \$76 ⁹⁹	 Stealth Gray 2882870-804 • \$65 ⁹⁹ 2883829-804 • \$65 ⁹⁹	 Onyx Black 2882870-866 • \$76 ⁹⁹				

REQUIRED POLARIS PULSE INSTALLATION ITEMS

GET SUPERIOR PERFORMANCE AND OUR BEST SEAL with the RANGER Pro Shield Cab System door line

360° GASKET SEAL

EASY TO CLEAN TPE LINER

BUILT-IN STORAGE

AUDIO-READY

VENTILATION OPTIONS

CAB COMFORT & CONVENIENCE



8-VENT HEATER & DEFROST SYSTEM



- Easily control the climate inside your cab in any season
- Helps defrost windshields and keeps you warm or cool
- Heat and fan dash-mounted controls
- Manual vents

» **TOP SELLER** 2882753 • \$1,289⁹⁹ **XP 1000 ONLY**

XP 1000 '18-22, CREW XP 1000 '19-22

» **TOP SELLER** 2884066 • \$1,289⁹⁹ **1000 ONLY**

CREW 1000 '20-22, 1000 '20-22
NEED ADAPTER: 2884163 ON CREW 1000

» **CREW HEATER ADAPTER KIT** **1000 ONLY**
2884163 • \$129⁹⁹

CREW 1000 '20-22



WINDSHIELD WIPER & WASHER SYSTEM



» 2883974 • \$749⁹⁹

XP 1000 '18-22, CREW XP 1000 '19-22,
CREW 1000 '20-22, 1000 '20-22

REQUIRES MOUNT KIT 2207624 FOR POLY WINDSHIELDS

HARD COAT POLY WINDSHIELD WIPER & WASHER SYSTEM MOUNTING BRACKET

» 2207624 • \$74⁹⁹

XP 1000 '17-22, CREW XP 1000 '18-22,
CREW 1000 '20-22, 1000 '20-22

REQUIRED TO USE WIPER ON 2883266 OR 2883300



FLOOR MATS - 3 SEAT

» 2882780 • \$169⁹⁹ **XP 1000 ONLY**

XP 1000 '18-22, CREW XP 1000 '19-22
CREW: FITS FRONT SEATS ONLY

» 2884247 • \$164⁹⁹ **1000 ONLY**

CREW 1000 '20-22, 1000 '20-22
CREW: FITS FRONT SEATS ONLY

NOISE REDUCTION SYSTEM

» 2883489 • \$359⁹⁹

XP 1000 '18-22, CREW XP 1000 '19-22,
1000 '20-22, CREW 1000 '20-22

DESIGNED TO ATTACH TO THE REAR CLOSURE PANEL OF YOUR RANGER CAB, THE SOUND ABSORBING MATERIAL REDUCES UNWANTED NOISE FOR A QUIETER CAB

UNDER SEAT DRY STORAGE

» 2882910 • \$269⁹⁹ **XP 1000 ONLY**

XP 1000 '18-22, CREW XP 1000 '19-22

WILL NOT WORK WITH SUBWOOFER 2882890 & 2884233



MULTI-FUNCTION CAB LIGHT



- LED dome light provides white, red, green and blue lighting options
- Battery-operated. Recharges when the vehicle is on
- Can be removed to use as a flashlight in and around your vehicle

- Red light is great for reading maps
- Green light is perfect for navigating in the dark
- Blue light is ideal for night riding

» 2882871 • \$134⁹⁹

XP 1000 '18-22, CREW XP 1000 '19-22, CREW 1000 '20-22, 1000 '20-22

REQUIRES ROOF PULSE: 2882904

REMOTE GARAGE DOOR OPENER BY HOMELINK®

- HomeLink® technology allows you to control up to two garage doors

» 2882892 • \$199⁹⁹

XP 1000 '18-22, CREW XP 1000 '19-22,
CREW 1000 '20-22, 1000 '20-22



POLARIS RANGER XP FULL-SIZE SEATSAVER - SPLIT BENCH SEAT



- Covers the back and bottom of seat

» POLARIS PURSUIT CAMO • 2883244-587 • \$299⁹⁹

» CARHARTT® BROWN • 2883244-218 • \$269⁹⁹

» CARHARTT® GRAVEL • 2883244-458 • \$269⁹⁹

XP 1000 '18-21, CREW XP 1000 '19-21
CREW: FITS FRONT SEATS ONLY

NO REAR SEAT COVERS AVAILABLE



SEAT CONFIGURATION

NEW SIDE VIEW MIRRORS

- Mounts on any RANGER vehicle that is equipped with doors
- Fully adjustable to accommodate riders of all sizes and can fold in to prevent being struck

» **DOOR MOUNTED** (shown) • 2889241 • \$219⁹⁹

» **ROPS-MOUNTED** • 2889243 • \$219⁹⁹

XP 1000 '18-22, CREW XP 1000 '19-22, CREW 1000 '20-22, 1000 '20-22



WORK BEACON LED LIGHT

- 50 ft. of illumination 360° around your vehicle
- Ideal for plowing, hunting and nighttime utility work
- Break-away construction protects the light in areas with tight clearance
- Mounted to the vehicle on the rear of the ROPS
- Easily hinge the light up during use and hinge it down when in transit
- Add LED Headlights for more light

» 2883265 • \$309⁹⁹

XP 1000 '18-22, CREW XP 1000 '19-22, CREW 1000 '20-22, 1000 '20-22
REQUIRES LIGHT BAR HARNESS/EXTENSION 2883230 AND 2883854



LED HEADLIGHTS



- LED Headlights offer improved brightness and illumination vs stock halogen lights
- Designed with styling specific to RANGER

» 2889072 • \$649⁹⁹

XP 1000 '18-22, CREW XP 1000 '19-22



REVERSE WARNING ALERT

» 2883246 • \$74⁹⁹

XP 1000 '18-22, CREW XP 1000 '19-22, CREW 1000 '20-22, 1000 '20-22
AUTOMATICALLY ACTIVATED WHENEVER THE VEHICLE IS PUT IN REVERSE

HORN



» 2882764 • \$89⁹⁹

XP 1000 '18-22, CREW XP 1000 '19-22, CREW 1000 '20-22, 1000 '20-22

LARGE REAR VIEW MIRROR



» 2879969 • \$94⁹⁹

XP 1000 '17-22, CREW XP 1000 '18-22, CREW 1000 '20-22, 1000 '20-22

WIDE ANGLE REAR VIEW MIRROR

- Large 2.5" x 14" adjustable convex mirrored surface gives you a full-spectrum view

» 2881439 • \$179⁹⁹

XP 1000 '17-22, CREW XP 1000 '18-22, CREW 1000 '20-22, 1000 '20-22

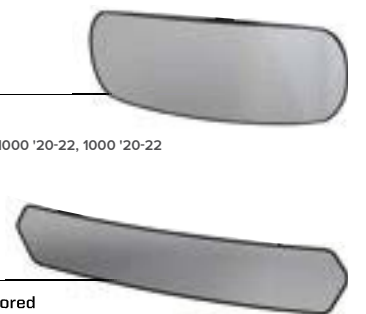

WINCHES

DEPENDABLE. TOUGH. BUILT FOR THE OFF-ROAD.

A Polaris Engineered winch is designed to help you get the job done right, get you on your way faster and prepare you for the unexpected.

WHY POLARIS?

Polaris off-road vehicles are engineered with designated mounting points and wiring for seamless install of Polaris Engineered winches.



TESTED **1,200+** PULLS AT MAX LOAD



BUILT TO WITHSTAND **-20° F** TEMPERATURES



OPERATES **FULLY SUBMERGED**



MILITARY TESTED & APPROVED

UPGRADE YOUR CONTROLS

NEW DASH WINCH SWITCH KIT

- Allows user to add a dash switch as an additional means to control winch
- Can be used with all winches and are compatible with other control methods (wireless/wired)

» 2889050 • \$83⁹⁹

XP 1000 '18-22, CREW XP 1000 '19-22, CREW 1000 '20-22, 1000 '20-22

TOP SELLER POWER CONTROLLER



WIRED REMOTE CONTROL

- Control winch/plow hydraulics from shift knob
- Handle and socket both required
- » REMOTE HANDLE • 4013466 • \$79⁹⁹
- » SOCKET • 4017102 • \$78⁹⁹

WORKS WITH ALL MODELS

XP 1000 '18-22, CREW XP 1000 '19-22, CREW 1000 '20-22, 1000 '20-22
REQUIRES WINCH ADAPTER 2884159 WHEN USING A WINCH FOR LIFTING DEVICE

REPLACEMENT PARTS

SYNTHETIC ROPE

6,000 LB. » 2879188 • \$229⁹⁹ 4,500 LB. » 2879187 • \$179⁹⁹



ADD A PLOW
P. 52

FEATURES & BENEFITS

ALL POLARIS ENGINEERED WINCHES COME WITH:



1 YR WARRANTY

- ✓ INTEGRATED WIRING, MOUNT, PREASSEMBLED
- ✓ HOOK WITH STRAP
- ✓ CUT STEEL GEARS & SEALED DRIVETRAIN
- ✓ SEALED PERMANENT MAGNET MOTOR

RAPID ROPE RECOVERY 5X FASTER

Retrieve cable 5x as fast as standard mode on other Polaris winches. Get back to riding or complete your task quicker.

1. Set winch dial to N (Neutral) to manually pull the rope out and secure the hook to your anchor point
2. Set winch dial to L (Low) for maximum pulling power while winching your load
3. Set winch dial to H (High) for retrieving the rope 5x faster with Rapid Rope Recovery

AUTO STOP TECHNOLOGY

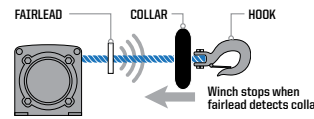

Auto Stop technology protects and extends the life of your winch by automatically stopping the winch at the end of pull to prevent over-spooling. While plowing, it prevents the plow frame from bending by stopping the winch once the plow has been lifted.

PREMIUM SYNTHETIC ROPE

With its lightweight, yet extremely strong, design and superior flexibility, this 50 ft long synthetic rope is easy to handle and can stand up to any tough job.

WIRELESS REMOTE

This convenient remote operates your Polaris winch wirelessly from within 50 ft of the vehicle. Operate your winch safely outside your vehicle while on the job site or trails.

PRO PRO HEAVY DUTY SERIES

TOP-OF-THE-LINE FEATURES
BEST FOR PLOWING, HEAVY-DUTY OUTDOOR CHORES & TRAIL RIDING



PRO PRO HEAVY DUTY SERIES

HD HEAVY DUTY SERIES

BUILT FOR THE OFF-ROAD
BEST FOR THE CASUAL OFF-ROAD RIDER



HD HEAVY DUTY SERIES

MODEL	6,000 LB.	4,500 LB.	4,500 LB.
XP 1000 '18-22 CREW XP 1000 '19-22 1000 '20-22 CREW 1000 '20-22 <small>NON EPS RANGER 1000 REQUIRES FRONT BUMPER</small>	<p>TOP SELLER</p> <p>2882710</p> <p>\$1,229⁹⁹</p>	<p>TOP SELLER</p> <p>2882711</p> <p>\$1,099⁹⁹</p>	<p>TOP SELLER</p> <p>2882714</p> <p>\$809⁹⁹</p>

3-SEAT & CREW

1000 / XP 1000

ROOFS

WINDSHIELDS

REAR PANELS

DOORS

CAB COMFORT & CONVENIENCE

WINCHES

PROTECTION

AUDIO

STORAGE

PROTECTION

PERFECT FOR: **INCREASED PROTECTION AROUND LIGHTING AND FENDERS**

STANDARD BRUSHGUARDS



INSTALLS DIRECTLY TO STOCK BUMPER

FRONT

HD BRUSHGUARDS

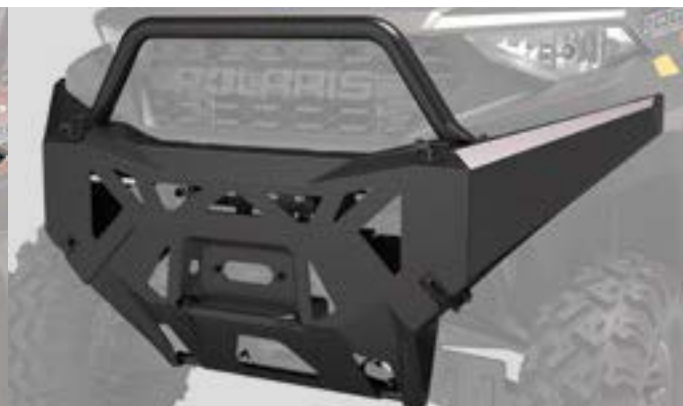

1 3/4" DIAMETER STEEL TUBE CONSTRUCTION

REAR



CAN BE USED IN CONJUNCTION WITH A TOW HITCH



- To use Front Bumper with RIDE COMMAND and Front Camera, RIDE COMMAND Bumper Adapter (2207941) is required
- » **TOP SELLER** FRONT • 2882531 • \$339⁹⁹ » **TOP SELLER** REAR • 2882529 • \$329⁹⁹
- XP 1000 '18-22, CREW XP 1000 '19-22, CREW 1000 '20-22, 1000 '20-22
FRONT BRUSHGUARD DOES NOT FIT HIGH LIFTER MODELS
1000 NON-EPS VEHICLES REQUIRE FRONT BUMPER: 2884123
- » RIDE COMMAND BUMPER ADAPTER • 2207941 • \$48⁷⁹
FOR USE ON VEHICLES WITH RIDE COMMAND AND FRONT CAMERA

- Increased protection over stock bumper with integrated mounting locations for accessories and lights (sold separately) with a durable matte black finish
- Easy installation with included mounting hardware
- Additional 36" storage area for recovery equipment
- » FRONT • 2885105 • \$899⁹⁹ » REAR • 2884217 • \$594⁹⁹
- XP 1000 '18-22, CREW XP 1000 '19-22, CREW 1000 '20-22, 1000 '20-22
FRONT BRUSHGUARD DOES NOT FIT HIGH LIFTER MODELS
REAR: RECOMMENDED WITH RIGID® OR PRO ARMOR POD LIGHTS FOR UPGRADED LIGHTING

NEW HIGH-MOUNTED FRONT BRUSHGUARD



FRONT BRUSHGUARD 1000 ONLY



- Increased protection over stock bumper
- Offers a higher winch mounting position which allows for easier access when used in deep mud
- Not compatible with Polaris Plow Systems
- » 2889271 • \$779⁹⁹
- XP 1000 '18-22, CREW XP 1000 '19-22, CREW 1000 '20-22, 1000 '20-22
REQUIRED TO INSTALL WINCH/PLOW ON NON EPS RANGER 1000
- Increased protection over stock bumper
- Sturdy stamped steel and tube construction
- Integrated mounting positions for plow and winch accessories
- » 2889330 • \$454⁹⁹
- CREW 1000 '20-22, 1000 '20-22
REQUIRED TO INSTALL WINCH/PLOW ON NON EPS RANGER 1000

NEW HIGH-MOUNTED HD 4,500 LB. WINCH WINTER AVAILABILITY



- Provides outstanding performance and versatile pulling power
- The elevated mounting position allows for easier access when used in deep mud
- » 2889272 • \$969⁹⁹
- XP 1000 '18-22, CREW XP 1000 '19-22, CREW 1000 '20-21, 1000 '20

ROCK GUARDS



3-SEAT



CREW

ROCK GUARD WITH STEP

- Reliable, hard-working protection for edges of vehicle
- Integrated step with boot scraper helps keep interior clean
- Mounts directly to the frame, instead of underneath, for maximum ground clearance
- Steel construction with black e-coat and durable black powder-coated finish

- » **TOP SELLER** 3-SEAT • 2882530 • \$329⁹⁹ » CREW • 2883398 • \$524⁹⁹
- XP 1000 '18-22, 1000 '20-22 CREW XP 1000 '19-22, CREW 1000 '20-22

A-ARMS



NEW HIGH CLEARANCE A-ARMS

- Valuable, reliable protection for vital front suspension components exposed to the rigors of off-road environments
- Strong, durable, lightweight polyethylene construction withstands off-road impacts to protect the A-Arms
- » FRONT • 2889269 • \$464⁹⁹ » REAR • 2889270 • \$464⁹⁹
- XP 1000 '18-22, CREW XP 1000 '19-22, CREW 1000 '20-22, 1000 '20-22 XP 1000 '18-22, CREW XP 1000 '19-22, CREW 1000 '20-22, 1000 '20-22

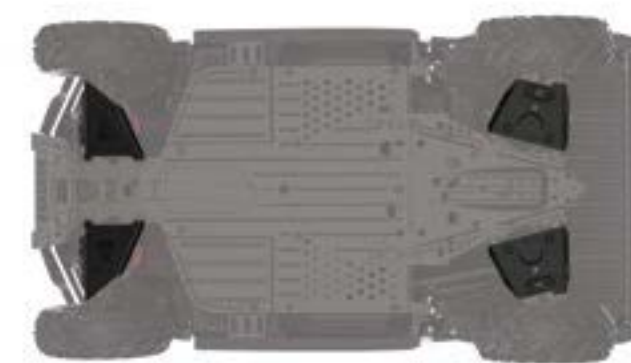

HMW A-ARM GUARDS

- Strong, 3/4" thick, durable, lightweight HMW (high molecular weight) polyethylene construction helps protect against off-road impacts
- Molded specifically for the RANGER XP 1000 & 1000 front suspension for a sure fit and low-profile presence
- Easy bolt-on design with mounting hardware included
- » FRONT • 2882784 • \$269⁹⁹ » REAR • 2882787 • \$269⁹⁹
- XP 1000 '18-22, CREW XP 1000 '19-22, CREW 1000 '20-22, 1000 '20-22 WILL NOT FIT ARCHED A-ARM MODELS XP 1000 '18-22, CREW XP 1000 '19-22, CREW 1000 '20-22, 1000 '20-22 WILL NOT FIT ARCHED A-ARM MODELS

AUDIO

BUILD YOUR AUDIO SYSTEM

OFF-ROAD GRADE AUDIO

When you research audio solutions, you'll see manufacturers bragging about how their audio equipment is "Marine Grade". Or worse yet, you'll discover they are repackaged components built for automotive applications. MB Quart®, combined with Polaris, engineers Off-Road Grade Audio equipment that's proven to deliver the loudest, crispest sound in the harshest conditions. Rain, snow, mud, heat, cold, dust—**ANY PLACE YOUR RANGER EXCELS, SO WILL YOUR AUDIO.**

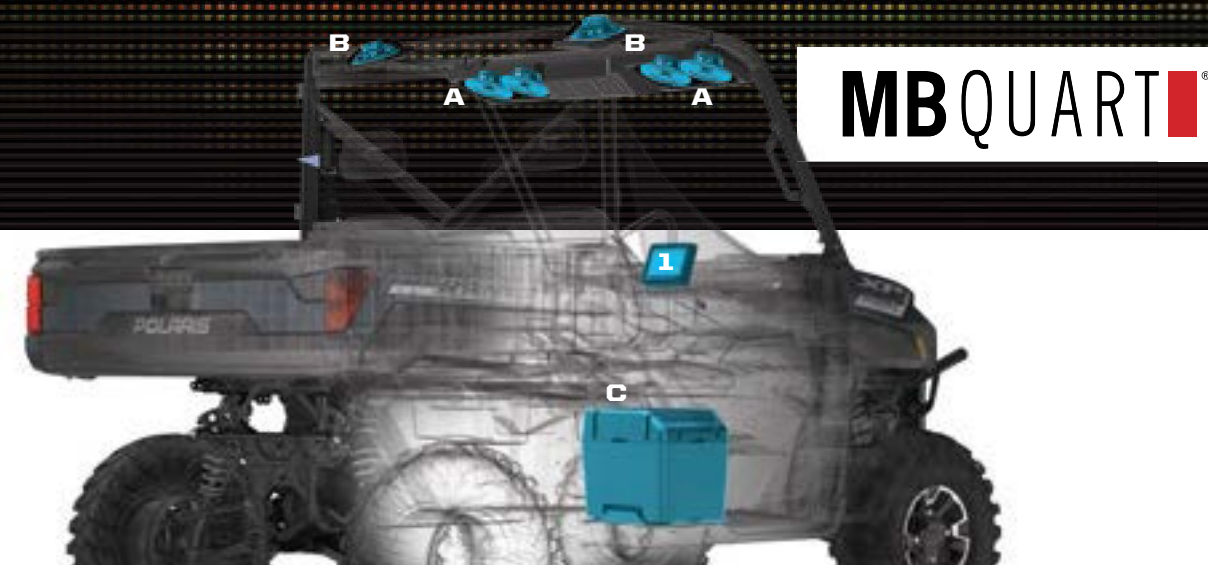

BUILD YOUR SOUND WITH RIDE COMMAND

STEP 1

ADD HEAD UNIT

7" DISPLAY POWERED BY RIDE COMMAND

2884072 • **\$1,999⁹⁹**

SEE P. 42 FOR MORE INFORMATION

STEP 2

ADD MOUNT

NEW

2889309 • **\$649⁹⁹**

XP 1000 '22, CREW XP 1000 '22, CREW 1000 '22, 1000 '22

FOR NORTHSTAR AND ALL OTHER MODELS WITHOUT 900 WATT

OR

NEW

2889310 • **\$649⁹⁹**

XP 1000 '22, CREW XP 1000 '22, CREW 1000 '22, 1000 '22

FOR 900 WATT STATOR

STEP 3 UPGRADE AUDIO BY ADDING VISOR OR DASH AUDIO

OPTION 1 VISOR AUDIO

<p>A. OVERHEAD VISOR SPEAKERS</p> <p style="text-align: center;">2882891 • \$809⁹⁹</p> <p>HARNES REQUIRED</p> <p style="text-align: center; font-size: x-small;">TOP SELLER 2882904 • \$129⁹⁹</p> <p style="text-align: center; font-size: x-small;">CREW MODELS REQUIRE ADDITIONAL 2883231</p>	+	<p>B. REAR OVERHEAD SPEAKERS</p> <p style="text-align: center; font-size: x-small;">TOP SELLER 2882876 • \$269⁹⁹</p> <p style="text-align: center; font-size: x-small;">XP 1000 '18-22, CREW XP 1000 '19-22, CREW 1000 '20-22, 1000 '20-22</p>	+	<p>C. 10" MAXBOOST SUBWOOFER</p> <p style="text-align: center;">2884233 • \$809⁹⁹</p> <p style="text-align: center; font-size: x-small;">XP 1000 '18-22, CREW XP 1000 '19-22 WITH 900 WATT STATOR</p>
OR				

OPTION 2 DASH AUDIO

<p>A. AUDIO DASH SPEAKERS</p> <p style="text-align: center; font-size: x-small;">TOP SELLER 2883956 • \$589⁹⁹</p> <p style="text-align: center; font-size: x-small;">XP 1000 '19-22, CREW XP 1000 '19-22, CREW 1000 '20-22, 1000 '20-22</p>	+	<p>B. REAR OVERHEAD SPEAKERS</p> <p style="text-align: center; font-size: x-small;">TOP SELLER 2882876 • \$269⁹⁹</p> <p style="text-align: center; font-size: x-small;">XP 1000 '18-22, CREW XP 1000 '19-22, CREW 1000 '20-22, 1000 '20-22</p>	+	<p>C. 10" MAXBOOST SUBWOOFER</p> <p style="text-align: center;">2884233 • \$809⁹⁹</p> <p style="text-align: center; font-size: x-small;">XP 1000 '18-22, CREW XP 1000 '19-22</p> <p style="text-align: center; font-size: x-small;">RANGER MODELS WITH RIDE COMMAND PACKAGE REQUIRE 2883232 ADAPTER HARNES</p>
--	---	---	---	---

AUDIO DASH SPEAKERS INCLUDE BUILT-IN FOUR CHANNEL AMPLIFIER (40-WATTS) AND TWO OFF-ROAD GRADE 5.25" SPEAKERS

<p>VISIT POLARIS.COM/SHOPRANGER FOR FITMENT FOR YOUR SPECIFIC MODEL & YEAR</p>	<p>DOWNLOAD THE RIDE COMMAND MOBILE APP</p> <div style="display: flex; justify-content: center; gap: 10px;"> </div>	<p>CHECK FOR FEATURE ENHANCEMENTS & UPDATES AT POLARIS.COM/RIDECOMMAND</p>
---	---	--

3-SEAT & CREW

1000 / XP 1000

ROOFS

WINDSHIELDS

REAR PANELS

DOORS

CAB COMFORT & CONVENIENCE

WINCHES

PROTECTION

AUDIO

STORAGE

AUDIO

BUILD YOUR AUDIO SYSTEM

OFF-ROAD GRADE AUDIO

MBQUART®

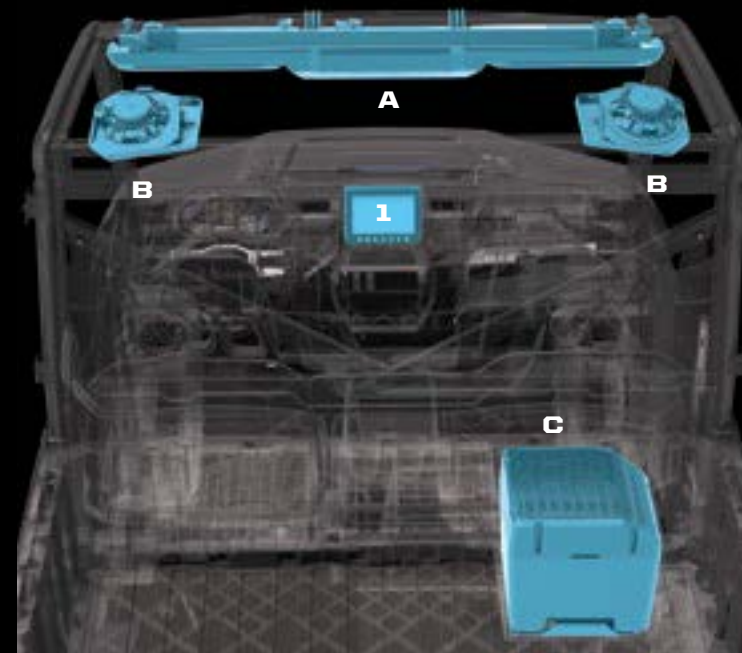

3-SEAT & CREW

1000 / XP 1000

ROOFS

WINDSHIELDS

REAR PANELS

DOORS

CAB COMFORT & CONVENIENCE

WINCHES

PROTECTION

AUDIO

STORAGE

1 CHOOSE A HEAD UNIT Control all aspects of your sound system. Choose what to listen to and how loud.



DASH STEREO

160 WATT, WATERPROOF AM/FM BLUETOOTH® AUDIO SYSTEM TOP SELLER



- All-in-one solution for giving your vehicle a performance-ready sound system
- USB input, Bluetooth® 4.0 compatible, Apple® Control, AM/FM tuner
- Built-in four channel amplifier (40-watts x 4)
- Two off-road grade 5.25" speakers with Titanium Dome Tweeters and Polypropylene Cones

» 2882750 • **\$809** ⁹⁹
 XP 1000 '18-22, CREW XP 1000 '19-22, CREW 1000 '20-22, 1000 '20-22

USE AS IS OR ADD ADDITIONAL SPEAKERS



VISOR STEREO

300 WATT AM/FM, BLUETOOTH® AUDIO VISOR WITH FOUR 6.5" WATERPROOF SPEAKERS TOP SELLER



- One-step solution for off-road audio
- USB input, Bluetooth® 4.0 compatible, Apple® Control, AM/FM tuner
- 300-Watt four channel amplifier (75 watts x 4)
- Four 6.5" coaxial speakers with titanium dome tweeters and polypropylene cones
- Audio outputs to drive additional speakers
- Four Accessory knocks outs
- Polaris PULSE Electrical System

» 2882888 • **\$1,069** ⁹⁹
 XP 1000 '18-22, CREW XP 1000 '19-22, CREW 1000 '20-22, 1000 '20-22
 NOT COMPATIBLE WITH 7" DISPLAY POWERED BY RIDE COMMAND

COMES WITH OVERHEAD VISOR SPEAKERS (AT RIGHT)
 USE AS IS OR ADD ADDITIONAL SPEAKERS

2 ADD SPEAKERS - MIX AND MATCH

Your RANGER is ready for work, but is it ready to entertain? From a simple two-speaker setup to a complete system - add speakers to BUILD IT YOUR WAY.



A VISOR SPEAKERS

STANDARD WITH VISOR STEREO

300 WATT OVERHEAD AUDIO VISOR SPEAKERS

- Built-in 300-Watt amplifier (75-watt x 4 channels)
- Four 6.5" speakers located in the overhead
- Waterproof system for reliable power and sound quality

» 2882891 • **\$809** ⁹⁹
 XP 1000 '18-22, CREW XP 1000 '19-22, CREW 1000 '20-22, 1000 '20-22



B OVERHEAD SPEAKERS

REAR OVERHEAD SPEAKERS TOP SELLER

- Two 6.5" rear roof mounted speakers with titanium dome tweeters and polypropylene cones
- Easy install
- Waterproof system for reliable power and sound quality

» 2882876 • **\$269** ⁹⁹
 XP 1000 '18-22, CREW XP 1000 '19-22, CREW 1000 '20-22, 1000 '20-22



C SUBWOOFER

MAX BOOST 10" 250 WATT SUBWOOFER XP 1000 ONLY

- Built-in 250-watt amplifier powering 10" waterproof subwoofer
- Fits RANGER XP 1000 with flip-up passenger seat

» 2882890 • **\$809** ⁹⁹
 XP 1000 '18-22, CREW XP 1000 '19-22
 NOT COMPATIBLE WITH 7" DISPLAY POWERED BY RIDE COMMAND, WILL NOT FIT WITH 2882910 STORAGE INSTALLED

3 MAKE IT WORK

VISOR STEREO HEAD UNIT

VISOR SPEAKERS

POLARIS PULSE ROOF 6

- Required with Visor Stereo (2882888)
- Required to add Visor Speakers (2882891)

» TOP SELLER 2882904 • **\$129** ⁹⁹
 XP 1000 '18-22, CREW XP 1000 '19-22, CREW 1000 '20-22, 1000 '20-22

CREW MODELS

CREW EXTENSION

- Required for all Crew models where Polaris PULSE Roof 6 Harness (2882904) is required

» 2883231 • **\$30** ⁹⁹
 CREW XP 1000 '19-22, CREW 1000 '20-22

NEW GEOFENCING KIT 1000 ONLY

- Keep vehicle operators safe by quickly setting and controlling ride boundaries within and outside the geofenced area
- Ensure operators are riding at the appropriate speed for their experience and terrain by setting a max speed from your RIDE COMMAND app
- Activate passcode protection and to have full control of who and when the vehicle is being operated

» 2884779 • **\$259** ⁹⁹
 CREW 1000 '20-22, 1000 '20-22

STORAGE



BRING IT ALL. BRING IT ON.

From opposite sides of the globe, the most capable machines in the off-road world meet a trusted outdoor adventure brand to deliver industry-exclusive, purpose-built roof racks, bed racks and accessories to help Polaris RANGER users have more fun and get more done. Increase storage capacity so you can go where you want with everything you need, organized to succeed.



MAXIMIZE YOUR RIDE

For decades, Rhino-Rack® has built some of the world's highest quality racks, accessories and mounts for the widest variety of uses and conditions. So whether you use your machine for hard work, hunting, fishing, and more, you can bring it all — and bring it on!



BUILD THE ULTIMATE UTILITY VEHICLE

Transform your vehicle for work, play or anything in between with durable and easy-to-use roof and bed racks, load securing accessories and the latest in carrier technology.



BUILT FOR THE LONG HAUL

Rhino-Rack® designs and builds award-winning racks, accessories and mounts to endure the most extreme uses and conditions.

PICK YOUR RACK



NEW REAR BED RACK / 3-SEAT ROOF RACK

- Can be used as Bed Rack or Roof Rack on 3-Seat models, depending on which mount is purchased. Bed Rack only on Crew models.

- Bed Rack and Roof Rack can be used together if both mounts are purchased

» 2889236 • \$649⁹⁹
XP 1000 '18-22, 1000 '20-22



NEW ROOF RACK - CREW

» 2889237 • \$649⁹⁹
CREW XP 1000 '19-22, CREW 1000 '20-22

PICK YOUR MOUNT



NEW REAR BED RACK MOUNT FALL AVAILABILITY

» 2889235 • \$519⁹⁹
XP 1000 '18-22, 1000 '20-22, CREW XP 1000 '19-22, CREW 1000 '20-22



NEW ROOF RACK MOUNT

» 3-SEAT • 2889233 • \$519⁹⁹
XP 1000 '18-22, 1000 '20-22

» CREW • 2889234 • \$519⁹⁹
CREW XP 1000 '19-22, CREW 1000 '20-22

ACCESSORIZE IT



NEW GUN MOUNTING BRACKET

- Bracket used to mount Kolpin Stronghold Gun Boots to Rhino-Rack® systems when paired with Auto-Latch Mount (2884106), sold separately

» 2889327 • \$64⁹⁹
XP 1000 '18-22, CREW XP 1000 '19-22, CREW 1000 '20-22, 1000 '20-22



NEW EYELET TIE-DOWNS

- Includes one set and hardware (straps not included) and attaches in multiple places on the platform to use as additional tie-down points
- Anti-corrosive galvanized steel for heavy-duty strength and long life

» 2889527 • \$73⁰⁰
XP 1000 '18-22, CREW XP 1000 '19-22, CREW 1000 '20-22, 1000 '20-22

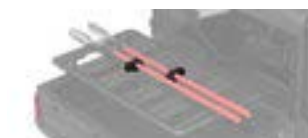

NEW MULTI-PURPOSE TOOL HOLDER

- Carry and protect tools, paddles, and more during your ride
- Ratchet-locking mechanism for quick release with rubber inserts to secure accessories into place

» 2889528 • \$104⁰⁰
XP 1000 '18-22, CREW XP 1000 '19-22, CREW 1000 '20-22, 1000 '20-22



NEW SPARE TIRE HOLDER

- Transport your spare tire outside your vehicle
- Easily mounts to your Rhino-Rack® Rear Bed Rack

» 2889529 • \$63⁰⁰
XP 1000 '18-22, CREW XP 1000 '19-22, CREW 1000 '20-22, 1000 '20-22



NEW TRACTION BOARD MOUNT

- Strong, durable mount is easy to attach to the Rhino-Rack® platform
- Traction board not included

» 2889530 • \$235⁰⁰
XP 1000 '18-22, CREW XP 1000 '19-22, CREW 1000 '20-22, 1000 '20-22



NEW CARGO CORNER BRACKET

- Bring your Polaris Northstar cooler along while saving space inside your vehicle
- Unique anti-rotation nut for maximum cargo security

» 2889531 • \$170⁰⁰
XP 1000 '18-22, CREW XP 1000 '19-22, CREW 1000 '20-22, 1000 '20-22



NEW HIGH-LIFTING JACK MOUNT

- Installs simply and quickly with durable brackets
- Rugged, non-corrosive powder-coated steel stands up to the harshest conditions

» 2889533 • \$147⁰⁰
XP 1000 '18-22, CREW XP 1000 '19-22, CREW 1000 '20-22, 1000 '20-22

STORAGE



LOCK & RIDE

Exclusive to Polaris, Lock & Ride accessories let you quickly change from one task to another with hundreds of options.

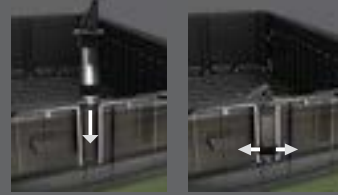

WITH THE FLIP OF A LEVER, LOCK & RIDE PLUNGERS USE OUTWARD PRESSURE TO EXPAND FOR A SECURE FIT.



CARGO BED REAR WINCH



- Assists lifting heavy objects like hay bales or big game up into rear cargo bed
- 300 lb. winch mounts high on rear cab frame
- Equipped with 15 ft. of premium synthetic rope

» 2884215 • \$707 ⁷⁹

XP 1000 '18-22, CREW XP 1000 '19-22, CREW 1000 '20-22, 1000 '20-22
REQUIRES ROOF PULSE: 2882904



LOCK & RIDE TIP-DOWN HEADACHE RACK

- Rack tips down for additional storage solutions with space below and multiple tie-down points
- Lightweight and heavy-duty rack protects the cab of your RANGER and lets you haul even more

» 2881531 • \$469 ⁹⁹

XP 1000 '17-22, CREW XP 1000 '18-22, CREW 1000 '20-22, 1000 '20-22



LOCK & RIDE BED EXTENDER/DIVIDER

- Extend or divide the cargo box
- Installs in any location in the box
- Multiple tie-down points available to secure cargo

» 2882752 • \$329 ⁹⁹

XP 1000 '18-22, CREW XP 1000 '19-22, CREW 1000 '20-22, 1000 '20-22



LOCK & RIDE FRONT BRUSHGUARD STORAGE RACK

- Allows extra storage space in front of your vehicle
- Accommodates a Polaris Northstar 30 Quart Cooler or similar sized items
- Attaches and removes easily
- Mounts to existing plow mounting points

» 2883971 • \$389 ⁹⁹

XP 1000 '18-22, CREW XP 1000 '19-22, CREW 1000 '20-22, 1000 '20-22



LOCK & RIDE CARGOMAX SYSTEM

- Comes standard with a support bar that ties the two sides together for a sturdy cargo hold
- Designed to attach to the Lock & Ride Tip-Down Headache Rack for additional support and three-sided containment

» 2882177 • \$669 ⁹⁹

XP 1000 '17-22, CREW XP 1000 '18-22, CREW 1000 '20-22, 1000 '20-22



LOCK & RIDE TONNEAU COVER

- Protects items stored in cargo bed from the elements
- HDPE construction on steel sub-frame can support up to 100 lbs. on top of cover
- Molded storage area for Polaris Northstar 30 Quart Cooler
- Convenient hinged middle panel for easy access
- Easy installation with Lock & Ride

» 2884218 • \$709 ⁹⁹

XP 1000 '18-22, CREW XP 1000 '19-22, CREW 1000 '20-22, 1000 '20-22



FRONT HOOD STORAGE RACK

- Front curve helps keep cargo in place when traveling
- Provides additional protection
- Fully integrated pivots to gain under-hood access
- Requires Bumper Adapter 2207941 when used with 7" Display powered by RIDE COMMAND

» 2882690 • \$469 ⁹⁹

XP 1000 '18-22, CREW XP 1000 '19-22, CREW 1000 '20-22, 1000 '20-22
DOES NOT FIT WITH BUMPER 2882531, REQUIRES 2207941 TO WORK WITH FRONT CAMERA



CANVAS STORAGE - CREW

- Attaches easily to the rear of the front seat in your crew vehicle
- Provides storage pockets for a variety of items, ensuring they're always within reach

» 2889268 • \$389 ⁹⁹

CREW XP 1000 '18-22, CREW '20-22

75+ COMBINATIONS TO MAKE IT YOUR OWN

With a full line of Lock & Ride accessories, you can haul more and do more. Use the chart below to see what combinations work together.

POLARIS RANGER STORAGE MATRIX XP 1000 / 1000 570 FULL-SIZE	LOCK & RIDE Tip-Down Headache Rack	LOCK & RIDE CargoMax System	LOCK & RIDE Bed Extender/Divider	LOCK & RIDE Storage Box	LOCK & RIDE Tool Rack	LOCK & RIDE Chainsaw Mount	LOCK & RIDE 60 Gallon Boomless Utility Sprayer	Cargo Bed Rear Winch	LOCK & RIDE Front Brushguard Storage Rack	LOCK & RIDE Tonneau Cover	Cargo Bed Mat	NEW RHINO-RACK Roof Rack - 3-Seat	NEW RHINO-RACK Bed Rack - 3-Seat & Crew	NEW RHINO-RACK Roof Rack - Crew
	2881531	2882177	2882752	2883279	2881533	2879354	2879799	2884215	2883971	2884218	2882751	2889236	2889236	2889237
LOCK & RIDE Tip-Down Headache Rack TOP SELLER	2881531	✓	✓	✓	✓	✓	✓	✓	✓	✓	✓	✓	✓	✓
LOCK & RIDE CargoMax System	2882177	✓	✓	✓ ²	✓	✓	✓	✓	✓	✓	✓	✓	✓	✓
LOCK & RIDE Bed Extender/Divider	2882752	✓	✓	✓	✓	✓	✓	✓	✓	✓	✓	✓	✓	✓
LOCK & RIDE Storage Box	2883279	✓	✓ ¹	✓	✓	✓	✓	✓	✓	✓	✓	✓	✓	✓
LOCK & RIDE Tool Rack	2881533	✓	✓	✓	✓	✓	✓	✓	✓	✓	✓	✓	✓	✓
LOCK & RIDE Chainsaw Mount	2879354	✓	✓	✓	✓	✓	✓	✓	✓	✓	✓	✓	✓	✓
LOCK & RIDE 60 Gallon Boomless Utility Sprayer	2879799	✓	✓	✓	✓	✓	✓	✓	✓	✓	✓	✓	✓	✓
Cargo Bed Rear Winch	2884215	✓	✓	✓	✓	✓	✓	✓	✓	✓	✓	✓	✓	✓
LOCK & RIDE Front Brushguard Storage Rack	2883971	✓	✓	✓	✓	✓	✓	✓	✓	✓	✓	✓	✓	✓
LOCK & RIDE Tonneau Cover	2884218	✓	✓	✓	✓	✓	✓	✓	✓	✓	✓	✓	✓	✓
Cargo Bed Mat	2882751	✓	✓	✓	✓	✓	✓	✓	✓	✓	✓	✓	✓	✓
NEW RHINO-RACK Roof Rack - 3-Seat	2889236	✓	✓	✓	✓	✓	✓	✓	✓	✓	✓	✓	✓	✓
NEW RHINO-RACK Bed Rack - 3-Seat & Crew	2889236	✓	✓	✓	✓	✓	✓	✓	✓	✓	✓	✓	✓	✓
NEW RHINO-RACK Roof Rack - Crew	2889237	✓	✓	✓	✓	✓	✓	✓	✓	✓	✓	✓	✓	✓

¹ Storage box at front of cargo box if not used with Tip-down Headache Rack

² Storage box at front of cargo box

LOCK & RIDE QUICKSTRAP

- The quickest and most secure way to mount Polaris accessories
- Sold as a pair

» 2882187 • \$59 ⁹⁹

ALL COOLERS, RANGER CARGO BOXES



LOCK & RIDE D-RINGS

- The most versatile Lock & Ride accessory - add as many as you need to secure your cargo with bungee cords or straps

» 2881545 • \$43 ⁹⁹

ALL RANGER CARGO BOXES



1.5" x 15' 5,500 LB RATCHET STRAP

- Heavy-duty webbing
- 5,500 lb. Maximum Load / 1,833 lb. Working Load

» 2884031 • \$59 ⁹⁹

2 Pack

2" x 20' 10,000 LB RATCHET STRAP

- Heavy-duty webbing
- 10,000 lb. Maximum Load / 3,300 lb. Working Load

» 2884032 • \$43 ⁹⁹

Floating D-Rings and Double J-Hooks

STORAGE

LOCK & RIDE
CHAINSAW MOUNT

- Can be secured to the outside of the bed wall so your chainsaw is within reach at all times

» 2879354 • \$179⁹⁹
XP 1000 '17-22, CREW XP 1000 '18-22, CREW 1000 '20-22, 1000 '20-22



LOCK & RIDE
60 GALLON BOOMLESS UTILITY SPRAYER

» 2879799 • \$1,209⁹⁹
XP 1000 '17-22, CREW XP 1000 '18-22, CREW 1000 '20-22, 1000 '20-22



BED ESSENTIALS

FIRE EXTINGUISHER HOLDER

- Only holds a 3.25" diameter extinguisher
- Quick release strap allows for easy use

» 2882158 • \$114⁹⁹
XP 1000 '17-22, CREW XP 1000 '18-22, CREW 1000 '20-22, 1000 '20-22



ELECTRONIC CARGO BOX LIFT

» 2884141 • \$799⁹⁹
XP 1000 '18-22, CREW XP 1000 '19-22, CREW 1000 '20-22, 1000 '20-22



RIDE & REPAIR ESSENTIALS KIT

» 2881207 • \$134⁹⁹
XP 1000 '17-22, CREW XP 1000 '18-22, CREW 1000 '20-22, 1000 '20-22



CARGO BED MAT

- Non-slip surface to better secure loads and keep cargo bed clean

» 2882751 • \$179⁹⁹
XP 1000 '18-22, CREW XP 1000 '19-22, CREW 1000 '20-22, 1000 '20-22



TOW & HAUL



TRAILER BALLS

» 2" WITH 3/4" SHANK
2877603 • \$18⁹⁹
» 1 7/8" WITH 3/4" SHANK
2877602 • \$18⁹⁹



2" BALL MOUNT

» 2" RECEIVER
2875320 • \$59⁹⁹



3:1 HITCHES

» 2" x 2" RECEIVER
2830522 • \$48⁷⁹
ALL RANGER MODELS
» 1 3/4" x 1 3/4" RECEIVER
2830523 • \$48⁷⁹
ALL RANGER MODELS



» 1 7/8" REPLACEMENT BALL
2830524 • \$12¹⁹
ALL RANGER MODELS



TASK-SPECIFIC TOOLS

LOCK & RIDE TOOL RACK

- Attach on the inside or outside of the cargo bed

» 2881533 • \$329⁹⁹
XP 1000 '17-22, CREW XP 1000 '18-22, CREW 1000 '20-22, 1000 '20-22



ORGANIZE & PROTECT

LOCK & RIDE STORAGE BOX

- Enough room to store all the tools you need to get the job done
- Internal organizational dividers keep gear from rolling around
- Easily detaches from vehicle

» 2883279 • \$439⁹⁹
XP 1000 '17-22, CREW XP 1000 '18-22, CREW 1000 '20-22, 1000 '20-22



DO MORE:



COOLERS
P. 46



HUNT
P. 48

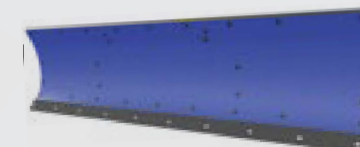

COLD WEATHER
P. 50



LIGHTING
P. 56

CONNECTED TECHNOLOGY

POLARIS RIDECOMMAND



PLAN. TRACK. SHARE. CONNECT.

PLAN YOUR RIDE

Plan an epic ride with stops along the way, customize and adjust your path to maximize your route or follow turn-by-turn directions. You can even share your planned route with friends.

INDUSTRY'S ONLY PLOW MODE

Allows for quicker snow removal with an adjusting plow position. When gear is in low, the plow automatically drops. When put in reverse, the plow automatically lifts.

WAYPOINTS

Follow user-defined locations to keep track of important locations like hunting stands or blinds, food plots, needed maintenance around the farm or ranch, and so much more.

BACK UP TO A TRAILER

The back-up camera now makes it easier and faster than ever to hook up a trailer, and automatically turns on when put in reverse.

TRAIL TECH



VOYAGER PRO

ADD ANY VEHICLE TO YOUR POLARIS GROUP RIDES

The Trail Tech Voyager Pro GPS seamlessly connects with 2020-2022 Polaris RIDE COMMAND 7" Displays. Join the group and ride.

THE CONNECTED RIDER'S GPS

Featuring Polaris Group Ride compatibility, custom maps, Bluetooth*, a 4" color touchscreen and full vehicle integration with gauges. Model-specific kits available for all UTV, ATV, snow and motorcycle brands.

AVAILABLE ON RIDE COMMAND MODELS & AS AN ACCESSORY

7" DISPLAY POWERED BY RIDE COMMAND

- **Bright, 7" touchscreen** visible in all conditions
- **GPS Navigation & Pre-Loaded Maps**
Available offline on the in-dash display so you always know where you are.
- **Route Planning**
Add points of interest and waypoints to make the most of your off-road adventure.
- **Group Ride**
"Follow the Leader" lets you set and follow the group leader on your display. Group Ride Messaging, lets you send messages to your group with or without a cellular signal.
- **Camera Integration**
Navigate with full view of your surroundings. Use the integrated rear camera to see others behind you while riding.
- **Personalized Audio Experience**
Seamlessly pair your display via Bluetooth* to wirelessly stream music and stay connected with call and text alerts.
- **Configurable Gauges**
Customize your ride experience with elevation, travel direction and more to create relevant screens for you.
- **Plow Mode**
Included on XP 1000 '18-20 and CREW XP 1000 '19-20 models (see P. 50 for details).

» 2884072 • \$1,999⁹⁹
XP 1000 '19-22, CREW XP 1000 '19-22, CREW 1000 '20-22, 1000 '20-22
SPEAKERS NOT INCLUDED. MUST CHOOSE AUDIO PACKAGE FOR AUDIO OUTPUT.

NEW RIDE COMMAND INSTALL MOUNT

- Necessary mount for your 7" Display Powered by RIDE COMMAND
- Seamless fit and finish
- Includes necessary wiring harness and reverse camera kits

» 2889309 • \$649⁹⁹
XP 1000 '22, CREW XP 1000 '22, CREW 1000 '22, 1000 '22
FOR NORTHSTAR AND ALL OTHER MODELS WITHOUT 900 WATT

» 2889310 • \$649⁹⁹
XP 1000 '22, CREW XP 1000 '22, CREW 1000 '22, 1000 '22
FOR 900 WATT STATOR

» 2889163 • \$649⁹⁹ FALL AVAILABILITY
SP 570 '22

LEARN MORE AND DOWNLOAD AT
[RIDECOMMAND.POLARIS.COM](https://ridecommand.polaris.com)



VOYAGER PRO KIT, UTV

- Bright, 4" touchscreen visible in all conditions
- **Pre-Loaded Base Maps**
The map screen is enabled with base maps, topography lines, hill shading and select trails. Record or load GPS trails/riding areas and transfer to a PC.
- **Buddy Tracking**
Track up to 20 group members no matter what type of vehicle they are riding.
- **Bluetooth* Enabled**
Bluetooth* enabled for intercom, phone and media controls. Play songs from your phone or MicroSD card using a Bluetooth* headset, speaker or intercom. Two phones and two headsets can be connected at the same time.

» 922-125 • \$779⁹⁹
AVAILABLE AT YOUR LOCAL DEALER OR ONLINE AT TRAILTECH.NET



LEARN MORE AT
[TRAILTECH.NET](https://trailtech.net)





ELECTRICAL ACCESSORIES

Polaris PULSE is a revolutionary way to provide additional power locations on your vehicle, and makes adding electrical accessories a snap. Electrical accessories are easier to install on the roof, with designated routing areas and plug and play connections.

Look for  to identify Polaris Pulse ready accessories.



ADD ELECTRICAL SYSTEM ACCESSORIES IN 4 EASY STEPS

STEP 1				
CHOOSE A POLARIS PULSE READY ROOF	XP 1000/1000	CREW XP 1000/1000	SP 570	CREW SP 570
Premium Roof - Poly - Polaris Pursuit Camo	2882913 \$929 ⁹⁹	2883277 \$1,599 ⁹⁹	N/A	N/A
Premium Roof - Poly - Black	2882912 \$734 ⁹⁹	N/A	N/A	N/A
Sport Roof - Poly - Black	2882911 \$454 ⁹⁹	2883274 \$709 ⁹⁹	2885077 \$519 ⁹⁹	2885078 \$519 ⁹⁹

THE FOLLOWING ACCESSORIES EASILY PLUG INTO THE FACTORY INSTALLED POLARIS PULSE UNDER THE HOOD:

	XP 1000/1000	SP 570
8-Vent Heater & Defrost System	P. 26	P. 74
Horn	P. 27	P. 74
Plow Controller	P. 28	P. 75
160 Watt, Waterproof AM/FM Bluetooth* Audio System	P. 32	P. 74
Light Bars	P. 56	P. 56



POLARIS PULSE UNDERHOOD BUS BAR - 6 POSITION 1000 ONLY

* If upgrading to more than three accessories attaching to the underhood PULSE location, replace 3-Position Bus Bar with the Polaris PULSE Underhood Bus Bar - 6 Position

» 2884183 • \$55⁹⁹
CREW 1000 '20-'22, 1000 '20-'22

POLARIS FRONT PULSE BAR AND HARNESS

* This kit is required to install any electrical accessories on a base RANGER SP 570

» 2889185 • \$109⁹⁹
SP 570 '22

POLARIS PULSE BATTERY TENDER ADAPTER

* Connects your BatteryMINDER® or trickle charger to your vehicle

» 2884297 • \$26⁹⁹
XP 1000 '18-'21, CREW XP 1000 '19-'22, CREW 1000 '20-'22, 1000 '20-'22, SP 570 '22, CREW SP 570 '22

STEP 2				
ADD THE POLARIS PULSE ROOF 6	XP 1000/1000	CREW XP 1000/1000	SP 570	CREW SP 570
Polaris PULSE Roof 6		2882904 \$129 ⁹⁹		
Polaris PULSE Wiring Harness - Crew Extension	N/A		2889185 \$109 ⁹⁹	

POLARIS PULSE READY ROOF WIRING EXAMPLE

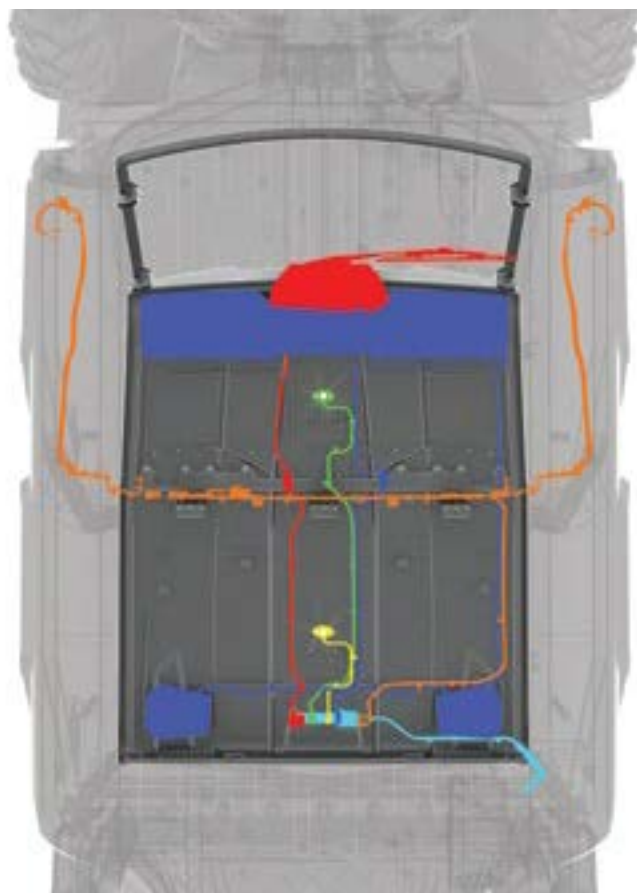

CREW XP 1000 POLARIS PULSE WIRING SHOWN

STEP 3 ADD ACCESSORIES*				
POWER WINDOW DOORS	XP 1000/1000	CREW XP 1000/1000	SP 570	CREW SP 570
Power Window Doors - Poly - Black	2884338 \$4,219 ⁹⁹		N/A	
Polaris PULSE Wiring Harness - Crew Extension	N/A	2883231 \$30 ⁹⁹	N/A	

WINDSHIELD WIPER & WASHER SYSTEM	XP 1000/1000	CREW XP 1000/1000	SP 570	CREW SP 570
Windshield Wiper & Washer System	2883974 \$749 ⁹⁹		2885083 \$649 ⁹⁹	
Polaris PULSE Wiring Harness - Crew Extension	N/A	2883231 \$30 ⁹⁹	2889185 \$109 ⁹⁹	

AUDIO: VISOR AUDIO + REAR SPEAKERS	XP 1000/1000	CREW XP 1000/1000	SP 570	CREW SP 570
300 Watt AM/FM, Bluetooth* Audio Visor with Four 6.5" Waterproof Speakers	2882888 \$1,069 ⁹⁹		N/A	
Rear Overhead Speakers	2882876 \$269 ⁹⁹		N/A	
Polaris PULSE Wiring Harness - Crew Extension	N/A	2883231 \$30 ⁹⁹	N/A	

AUDIO: DASH RADIO & VISOR SPEAKERS	XP 1000/1000	CREW XP 1000/1000	SP 570	CREW SP 570
160 Watt, Waterproof AM/FM Bluetooth* Audio System	2882750 \$809 ⁹⁹		N/A	
300 Watt Overhead Audio Visor Speakers	2882891 \$809 ⁹⁹		N/A	
JBL® Dash Audio Kit	N/A		2885081 \$899 ⁹⁹	
Polaris PULSE Wiring Harness - Crew Extension	N/A	2883231 \$30 ⁹⁹	2889185 \$109 ⁹⁹	

MULTI-FUNCTION DOME LIGHT	XP 1000/1000	CREW XP 1000/1000	SP 570	CREW SP 570
Multi-Function Cab Light (Front) †	2882871 \$134 ⁹⁹		2889159 \$139 ⁹⁹	
Polaris PULSE Wiring Harness - Crew Extension	N/A	2883231 \$30 ⁹⁹	2889185 \$109 ⁹⁹	

*Add accessories to models without 7" Display Powered by RIDE COMMAND
†To add a Multi-Function Dome Light for rear passengers, add an additional 2882871

STEP 4 FINISHING TOUCH				
CONCEAL WIRING FOR A FINISHED, COMFORTABLE LOOK	XP 1000/1000	CREW XP 1000/1000	SP 570	CREW SP 570
Premium Roof Liner	2882914 \$269 ⁹⁹	2883457 \$339 ⁹⁹	2885093 \$464 ⁹⁹	2885094 \$779 ⁹⁹



EASILY ADD LIGHTING

With Polaris PULSE it's easy to add RIGID® and Pro Armor lighting to your RANGER. All LED Light bars listed on P. 56-57 are Polaris PULSE ready, making installation that much easier.

POLARIS PULSE LIGHT BAR WIRING LOCATIONS

FRONT BUMPER // ROOF - FRONT MOUNTED // ROOF - REAR MOUNTED // *CREW ROOF - REAR MOUNTED

*Requires Extension

RANGER XP 1000 / 1000	RANGER SP 570
1 LIGHT WITH 1 SWITCH	
TOP SELLER Polaris PULSE Wiring Harness - 1 LED Light Bar - 2883230 • \$119 ⁹⁹	Polaris PULSE Wiring Harness - 1 LED Light Bar - 2889161 • \$119 ⁹⁹
2 LIGHTS WITH 1 SWITCH	
TOP SELLER Polaris PULSE Wiring Harness - 1 LED Light Bar - 2883230 • \$119 ⁹⁹ Y-Harness - 2879860 • \$23 ⁹⁹	N/A
2 LIGHTS WITH 2 SWITCHES	
TOP SELLER Polaris PULSE Wiring Harness - 1 LED Light Bar - 2883230 • \$119 ⁹⁹	Polaris PULSE Wiring Harness - 1 LED Light Bar - 2889161 • \$119 ⁹⁹
TOP SELLER Polaris PULSE Wiring Harness - 1 LED Light Bar - 2883230 • \$119 ⁹⁹	Polaris PULSE Wiring Harness - 1 LED Light Bar - 2889161 • \$119 ⁹⁹
EXTENSIONS FOR CREW	
Polaris PULSE Wiring Harness - 1 LED Light Bar - Crew Extension 2883231 • \$30 ⁹⁹	N/A

COMMON

3-SEAT & CREW / 2-SEAT & CREW

CONNECTED TECHNOLOGY

ELECTRICAL ACCESSORIES

COOLERS

HUNT

COLD WEATHER

PLOWS

LIGHTING

WHEELS & TIRES

KEEP IT
ICE COLD

GRIZZLY TESTED.
POLARIS APPROVED.



This cooler is IGBC-approved, meaning it withstands the power expended by a typical grizzly bear if it was trying to get inside.

Seriously, there are experts who know what a grizzly is capable of doing, and they certify our coolers can take it.



30, 60 & 105
QUART FEATURES



ComfortCarry Handles



TravelLock System



EasyOut Drain System



NoSlip Rubber Feet



PolarWall Insulation



IceLock Seal

POLARIS NORTHSTAR COOLERS CAN SURVIVE JUST ABOUT ANYTHING - FROM EXTREME HEAT TO A NASTY TUMBLE OFF A VEHICLE.



105 QUART

» GRAPHITE • 2883426 • **\$509⁹⁹**
» DESERT • 2883392 • **\$509⁹⁹**



60 QUART

» GRAPHITE • 2883425 • **\$409⁹⁹**
» DESERT • 2881259 • **\$409⁹⁹**



30 QUART

» GRAPHITE • 2883424 • **\$309⁹⁹**
» DESERT • 2881315 • **\$309⁹⁹**



15 QUART

» GRAPHITE • 2883968 • **\$249⁹⁹**



NEW
20 QUART SOFT-SIDED COOLER

» 2889285 • **\$219⁹⁹**

HOLDS ICE
30+
HOURS
LONGER
THAN YETI^{®*}

*YETI is a registered trademark of YETI COOLERS, LLC

ESSENTIAL ACCESSORIES SO YOUR COOLER WORKS AS HARD AS YOU DO

COOLER ACCESSORIES	105 QUART	60 QUART	30 QUART	DON'T FORGET THESE ACCESSORIES		
WIRE BASKET	2883648 • \$59⁹⁹	2882185 • \$43⁹⁹	2882438 • \$36⁹⁹	TUMBLERS	LOCK & RIDE QUICKSTRAP	BOTTLE OPENER
DIVIDERS Doubles as cutting board	2883468 • \$43⁹⁹ COMES WITH ONE DIVIDER 1 way to partition	2882184 • \$59⁹⁹ COMES WITH TWO DIVIDERS 2 ways to partition	2882186 • \$30⁹⁹ COMES WITH ONE DIVIDER 1 way to partition	» 30 OZ (shown) • 2883394 • \$36⁹⁹ » 20 OZ • 2883393 • \$30⁹⁹	» 2882187 • \$59⁹⁹ ALL COOLERS AND POLARIS RANGER CARGO BOXES	» 2882183 • \$15⁹⁹ ALL COOLERS
SEAT CUSHION	NOT AVAILABLE	2882179 • \$114⁹⁹	2882507 • \$89⁹⁹			
WHEELS	2883967 • \$119⁹⁹	2882180 • \$124⁹⁹	NOT AVAILABLE			

PROTECTING YOUR ESSENTIAL GEAR SINCE 1943



KOLPIN STRONGHOLD SYSTEM

Polaris is proud to partner with Kolpin Outdoors, an industry leader in off-road accessories and the premier name in gun boots and mounts. If you need to secure a firearm while riding, simply attach the auto-latch mount and choose your Gun Boot.

IDEAL FOR SECURE TRANSPORT OF SCOPED RIFLES AND SHOTGUNS



STEP 1 CHOOSE YOUR MOUNT



LOCK & RIDE KOLPIN STRONGHOLD AUTO-LATCH DOUBLE BOOT MOUNT

- Precision angle adjustable for a custom fit
- Provides a quick and secure attachment point

» **DOUBLE BOOT MOUNT** • 2883970 • **\$234⁹⁹**
» **SINGLE BOOT MOUNT** • 2884106 • **\$83⁹⁹**

» **2882159 • \$554⁹⁹**
XP 1000 '17-22, CREW XP 1000 '18-22, CREW 570 FULL SIZE '18-22, CREW 1000 '20-22, 570 FULL SIZE '17-22, 1000 '20-22

RHINO-RACK[®]



NEW RHINO-RACK[®] - GUN BOOT MOUNT

- Use to equip Kolpin Stronghold Auto-Latch Mount for attaching gun boot mounts to Rhino-Rack[®]

» **2889337 • \$349⁹⁹**
XP 1000 '18-22, CREW XP 1000 '19-22, CREW 1000 '20-22, 1000 '20-22
REQUIRES AUTO-LATCH MOUNT 2884106 TO MOUNT TO VEHICLE
SEE P. 36 FOR MORE RHINO-RACK[®] PRODUCTS

STEP 2 CHOOSE YOUR BOOTS



KOLPIN STRONGHOLD GUN BOOT XL

- Lockable and TSA approved
- Includes padded, zippered internal protective liner
- 52" L x 3 3/4" W x 10 1/2" H

» **2882036 • \$109⁹⁹**
REQUIRES AUTO-LATCH MOUNT 2883970 OR 2884106 TO MOUNT TO VEHICLE

KOLPIN STRONGHOLD GUN BOOT L

- 52" L x 4 3/4" W x 9 3/4" H

» **2882426 • \$83⁹⁹**
REQUIRES AUTO-LATCH MOUNT 2883970 OR 2884106 TO MOUNT TO VEHICLE

CARGO BED REAR WINCH

- Assists lifting heavy objects like hay bales or big game up into rear cargo bed
- 300 lb. winch mounts high on rear cab frame
- Equipped with 15 ft. of premium synthetic rope

» **2884215 • \$707⁹⁹**
XP 1000 '18-22, CREW XP 1000 '19-22, CREW 1000 '20-22, 1000 '20-22



KOLPIN RHINO GRIPS IDEAL FOR CARRYING RIFLES, SHOTGUNS, BOWS AND CROSSBOWS



LOCK & RIDE RHINO GRIP PRO

» **2884107 • \$109⁹⁹**
ALL RANGER MODELS (EXCEPT 150 EFI)



LOCK & RIDE RATCHETING RHINO GRIP

» **2881575 • \$90⁹⁹**
ALL RANGER MODELS (EXCEPT 150 EFI)



LOCK & RIDE RHINO GRIP XLR

» **2881574 • \$55⁹⁹**
ALL RANGER MODELS (EXCEPT 150 EFI)



LOCK & RIDE RHINO GRIP XLR DOUBLES

» **2889166 • \$94⁹⁹**
ALL RANGER MODELS (EXCEPT 150 EFI)



RHINO GRIP PRO REPLACEMENT RUBBER STRAPS (2)

» **2884109 • \$11⁹⁹**
RHINO GRIP PRO



RHINO GRIP XLR REPLACEMENT RUBBER STRAPS (2)

» **2889204 • \$11⁹⁹**
RHINO GRIP XL

LOCK & RIDE GUN RACK 6

- Adjustable to store guns at an angle or vertical (shown at angle)
- Holds six rifles or shotguns securely with soft rubber v-grips
- Stock is secured in place with a soft molded rubber inlay along the bottom of the rack
- Rack can be adjusted into three positions based on firearm height

» **2882159 • \$554⁹⁹**
XP 1000 '17-22, CREW XP 1000 '18-22, CREW 570 FULL SIZE '18-22, CREW 1000 '20-22, 570 FULL SIZE '17-22, 1000 '20-22



IN-CAB GUN MOUNT

- Gives you instant gun access in the field
- Mounts securely to the floor and adjusts up to 45° forward
- Robust, molded gun butt holder at base
- Quick-release barrel straps
- Easily removable
- Accommodates scope-equipped rifles

» **2883263 • \$209⁹⁹**
XP 1000 '18-22, CREW XP 1000 '19-22, CREW 1000 '20-22, 1000 '20-22
NORTHSTAR EDITION REQUIRES 2208023 HWD KIT TO INSTALL ON THE 2019 AND NEWER MODELS



POLARIS PURSUIT CAMO SxS FIELD COVER

- Full-coverage camo print cover hides your side-by-side while in the field
- Lightweight material protects your RANGER from inclement weather

» **2882160 • \$169⁹⁹**
XP 1000 '18-22, EV '11-22, 570 FULL SIZE '17-22, 570 '14-21, SP 570 '22, 500 '11-22, 1000 '20-22

COLD WEATHER

GET READY FOR WINTER WITH PLOWS AND TRACKS.
SEE P. 52 FOR PLOW DETAILS

POLARIS PLOW MODE

EXCLUSIVE TO RANGER XP 1000 RIDE COMMAND FOR 2020-2022

7" DISPLAY POWERED BY RIDE COMMAND

» 2884072 • \$1,999⁹⁹

XP 1000 '19-22, CREW XP 1000 '19-22, CREW 1000 '20-22, 1000 '20-22

SEE P. 42

Plow mode functionality does not control hydraulic lift and angle



PLOW IS AUTOMATICALLY LOWERED WHEN SHIFTING INTO LOW



PLOW IS AUTOMATICALLY RAISED WHEN SHIFTING INTO REVERSE



BACK DRAG MODE ALLOWS FOR PULLING SNOW AWAY FROM BUILDINGS



PROSPECTOR PRO TRACK MOUNT KIT

• Install this track system mounting hardware in place of tires and wheels. Tracks sold separately.

» 2889425 • \$649⁹⁹ **NEW**

XP 1000 '21-22, CREW XP 1000 '21, CREW 1000 '20-22, 1000 '21-22. FITS MODELS WITH NON-HIGH CLEARANCE A-ARMS

» 2889426 • \$649⁹⁹ **NEW**

XP 1000 '21-22, CREW XP 1000 '21-22. FITS MODELS WITH HIGH CLEARANCE A-ARMS

» 2882783 • \$649⁹⁹

XP 1000 '18-21, CREW XP 1000 '19-21, CREW 1000 '20-21, 1000 '20-21

» 2880071 • \$649⁹⁹

CREW 570-4 '15-21, 570 '14-21, 500 '17-22

» 2889196 • \$599⁹⁹

SP 570 '22

PROSPECTOR PRO TRACK

» 2880758 • \$6,449⁹⁹

570 '14-21 WITH EPS, CREW 570 '14-21 WITH EPS, SP 570 '22, CREW SP 570 '22

» 2880757 • \$6,449⁹⁹

CREW 570-4 '14-21, 570 '14-21, 500 '17-22

If using Glacier Pro Plow System with tracks, Track Plow Extension is required (2889267)

For year-round use, Polaris recommends the use of Intake Update Kit (2880673) on any RANGER XP 1000 '17, RANGER XP 1000 CREW '14-18 with tracks installed. To keep intake system working optimally, this kit pre-filters out fine snow and dust.

POLARIS-SPECIFIC GEARING PROVIDES 1:1 RATIO TO:

- Minimize track slip, providing better climbing ability and improved traction in deep snow
- Improve top speed over prior models by approximately 5%
- Reduce operating RPM for a quieter ride
- Improve driveline durability, which allows vehicle to run at a lower RPM, decreasing engine wear

New front dual stabilizer for improved stability



Polaris Exclusive optimized hub geometry that minimizes feedback and eases steering effort

Lightweight design provides for better flotation, eases steering effort, and provides better vehicle control

Otter®



FEATURES

- Fits 1-2 people
- 26.5 square ft.
- Set up dimensions: 67" L x 59 1/4" W x 78 1/2" H
- Cover included
- 2 top sealable vents
- Front entry door with dual coil zippers
- 2 sewn-in TPU crack resistant windows
- Insulated corners for complete coverage
- Interior draft skirt with extra-long perimeter



WARRANTY

POLARIS RANGER COMPATIBLE MODELS



XP 1000 '15-22, CREW XP 1000 '16-22, CREW 1000 '20-22, 1000 '20-22



CREW 570 FULL SIZE '18-22, 570 FULL SIZE '17-22

LOCK & RIDE

Polaris XT Pro Lodge by Otter

» 2882199 • \$1,289⁹⁹

VEHICLE WITH TRACKS WILL REDUCE SITTING SPACE IN HOUSE SLIGHTLY



LOCK & RIDE Easy On & Off



Room for Ice Fishing Gear



Comfortable Fishing for 2
Seating not included

EASY SET UP

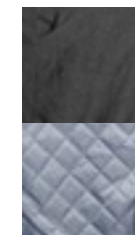
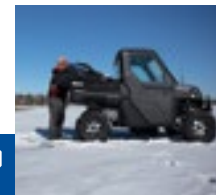

OUTER SHELL
Provides outstanding wind and light blocking capabilities

INNER LINING
The full thermal quilted inner shell provides higher lofting while locking in heat and virtually eliminating condensation



LIGHTWEIGHT
Oversized square tube aluminum frame with anodized receiver tubes and ultra-glide operation



"The full-thermal Otter® Ice House from Polaris sets up in minutes, is spacious enough for two anglers to fish in comfort and stows quickly on the back of your RANGER. It is the premium shelter solution for ice anglers that rely on their Polaris RANGER for mobility out on the ice."

- James Holst, InDepth Outdoors

Otter® is a registered trademark of Otter Outdoors, LLC

REAR 27" TIRE CHAINS

- Improve traction in deep snow and icy terrain
- Designed to fit on the 11" wide rear tires of the RANGER XP 1000

» 2889242 • \$189⁹⁹

COMMON

3-SEAT & CREW / 2-SEAT & CREW

CONNECTED TECHNOLOGY

ELECTRICAL ACCESSORIES

COOLERS

HUNT

COLD WEATHER

PLOWS

LIGHTING

WHEELS & TIRES

GLACIER PRO HD PLOW SYSTEM

HYDRAULIC CONTROL FOR EXTREME SNOW REMOVAL

A robust frame and tough blades, combined with a convenient hydraulic angle system, allow your Glacier Pro HD to move serious snow while you remain comfortable. Thanks to Lock & Ride technology, the Pro HD comes standard with a convenient kickstand attachment to the plow frame, giving you the easiest attachment.

XP 1000/1000 PLOW SYSTEMS (REQUIRES WINCH, SOLD SEPARATELY)

Choose a Glacier Pro HD Plow System, designed to help you get the most out of your RANGER during snowy months. Select a system based on your plowing needs with premium add-ons including a hydraulic lift system or additional plow accessories.

NEW GLACIER PRO HD PLOW SYSTEM WITH HYDRAULICS & ACCESSORIES

- System includes:
- Frame (2883255)
 - 72" Poly Plow (2879317)
 - Hydraulic Angle (2885103)
 - Hydraulic Controller (2883247)
 - Plow Markers (2872726)
 - Back Drag Bar (2889329)
 - Plow Extensions (2889328)

» 3880002 • \$3,639⁹⁹
 XP 1000 '18-22, CREW XP 1000 '19-22, CREW 1000 '20-22, 1000 '20-22
 REQUIRES LIFT METHOD: SEE WINCHES

NEW GLACIER PRO HD PLOW SYSTEM WITH HYDRAULICS

- System includes:
- Frame (2883255)
 - 72" Poly Plow (2879317)
 - Hydraulic Angle (2885103)
 - Hydraulic Controller (2883247)
 - Plow Markers (2872726)

» 3880003 • \$3,187⁹⁹
 XP 1000 '18-22, CREW XP 1000 '19-22, CREW 1000 '20-22, 1000 '20-22
 REQUIRES LIFT METHOD: SEE WINCHES

NEW GLACIER PRO HD PLOW SYSTEM

- System includes:
- Frame (2883255)
 - 72" Steel Plow (2879874)

» 3880004 • \$2,012⁹⁷
 XP 1000 '18-22, CREW XP 1000 '19-22, CREW 1000 '20-22, 1000 '20-22
 REQUIRES LIFT METHOD: SEE WINCHES

BUILD YOUR XP 1000/1000 PLOW SYSTEM

» 72" Blades

» Choice of poly or steel

» Hydraulic lift & angle system option

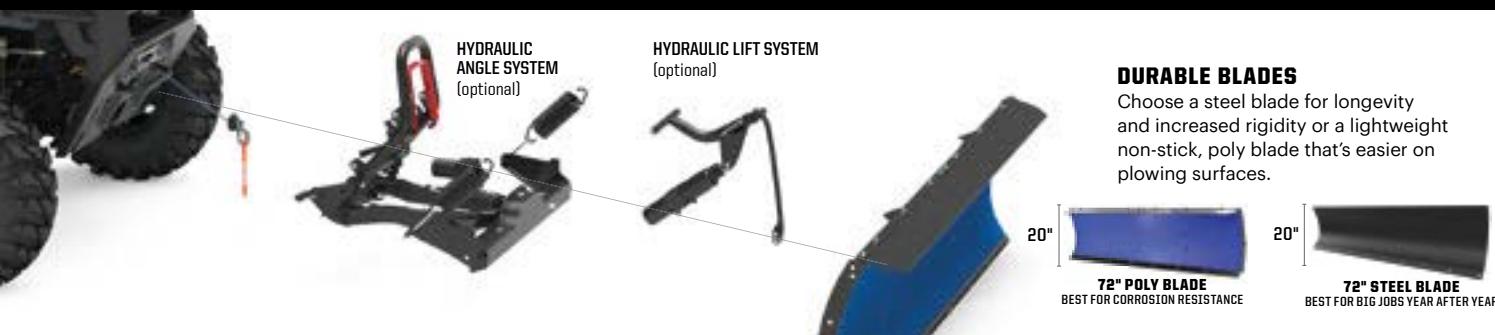

HYDRAULIC ANGLE SYSTEM (optional)

HYDRAULIC LIFT SYSTEM (optional)

DURABLE BLADES
 Choose a steel blade for longevity and increased rigidity or a lightweight non-stick, poly blade that's easier on plowing surfaces.

20" 72" POLY BLADE
 BEST FOR CORROSION RESISTANCE

20" 72" STEEL BLADE
 BEST FOR BIG JOBS YEAR AFTER YEAR

BUILD YOUR PLOW SYSTEM	STEP 1 SELECT A MOUNT	STEP 2 SELECT A FRAME	STEP 3 SELECT PLOW CONFIGURATION		STEP 4 SELECT A BLADE
MODELS	MOUNT	FRAME	HYDRAULICS	WINCHES	BLADES
XP 1000 '18-22 CREW XP 1000 '19-22 1000 '20-22 CREW 1000 '20-22	Not Required Integrated into Factory Bumper NON EPS RANGER 1000 REQUIRES FRONT BUMPER	NEW 2889308 \$1,419 ⁹⁹ <small>FALL AVAILABILITY</small> Track Extension 2879871 \$609 ⁹⁹ Replacement T Shear Pin 2204829 \$7 ⁹⁹ Glacier Pro HD Kickstand System 2207382 \$30 ⁹⁹	Hydraulic Lift System 2883410 \$609 ⁹⁹ Glacier Pro HD Plow Hydraulic Angle System 2885103 \$669 ⁹⁹ <small>TOP SELLER</small> Power Controller Required for hydraulic components 2883247 \$269 ⁹⁹	Polaris Pro HD 6,000 lb. Winch 2882710 \$1,229 ⁹⁹ <small>TOP SELLER</small> Polaris Pro HD 4,500 lb. Winch 2882711 \$1,099 ⁹⁹ Power Controller Winch Adapter 2884159 \$69 ⁹⁹	72" Poly 2879317 \$809 ⁹⁹ <small>TOP SELLER</small> 72" Steel 2879874 \$609 ⁹⁹

SELECT ACCESSORIES

PLOW BLADE SNOW DEFLECTOR

- » 72" • 2858541 • \$89⁹⁹
- » 66" • 2879866 • \$114⁹⁹
- » 60" • 2871808 • \$89⁹⁹

HEAVY-DUTY SNOW PLOW DEFLECTOR

- » 72" • 2884160 • \$194⁹⁹

QUICK RELEASE SKID SHOES

- Helps prevent blade wear
- Hardened steel for industrial strength
- » 2205223 • \$43⁹⁹

COIL SPRING SPACER

- Keep the front end of the vehicle up and improve ride quality when using a plow on strut or A-Arm vehicles
- » 2872655 • \$24⁹⁹

NEW WINTER AVAILABILITY GLACIER 6" PLOW EXTENSIONS

- 6" steel plow extensions that attach to the side of 66" and 72" Glacier Pro HD plows
- » 2889328 • \$324⁹⁹

WEAR BARS

- Protect your plow blade and minimize wear on the actual blade
- » 72" • 2204976 • \$74⁹⁹
- » 66" • 2879867 • \$74⁹⁹
- » 60" • 2877243 • \$48⁹⁹
- » HD 72" • 2879875 • \$139⁹⁹
- » HD 66" • 2879868 • \$134⁹⁹

NEW PLOW BACK DRAG BAR

- Has a hinged, rear facing cutting edge that improves back dragging performance and allows the bar to float when plowing forward to reduce wear and tear
- » 2889329 • \$129⁹⁹

QUICK RELEASE SKID SHOES

- Helps prevent blade wear
- Hardened steel for industrial strength
- » 2208864 • \$34⁷⁹

PLOW MARKER

- Helps driver monitor plow blade position
- Sold in pairs
- » 2872726 • \$43⁹⁹

PLOW LINK

- » 2204974 • \$23⁹⁹

POLARIS SP 570 PLOW SYSTEMS (REQUIRES WINCH, SOLD SEPARATELY)

NEW GLACIER PRO HD PLOW SYSTEM WITH HYDRAULICS

- System includes:
- Frame (2880260)
 - 72" Steel Plow (2880270)
 - Hydraulic Angle (2885104)
 - Hydraulic Controller (2889162)
 - Plow Markers (2872726)

» 3880006 • \$2,503⁹⁹
 SP 570 '22 & CREW SP 570 '22
 REQUIRES LIFT METHOD: SEE WINCHES

NEW GLACIER PRO HD PLOW SYSTEM (NON BASE MODELS)

- System includes:
- Frame (2880260)
 - 66" Poly Plow (2880269)

» 3880007 • \$1,148⁰⁷
 SP 570 '22 & CREW SP 570 '22
 REQUIRES LIFT METHOD:
 SEE WINCHES AND HYDRAULIC LIFT OPTION

NEW GLACIER PRO HD PLOW SYSTEM (BASE MODELS ONLY)

- System includes:
- Mount (2880261)
 - Frame (2880260)
 - 66" Poly Plow (2880269)

» 3880008 • \$1,483⁹⁸
 SP 570 '22 & CREW SP 570 '22
 REQUIRES LIFT METHOD:
 SEE WINCHES AND HYDRAULIC LIFT OPTION

BUILD YOUR SP 570/570/500/570 FULL-SIZE PLOW SYSTEM

» 72" or 66" Blades

» Choice of poly or steel

» Hydraulic angle system option



HYDRAULIC ANGLE SYSTEM (optional)

17" 66" POLY BLADE
 BEST FOR CORROSION RESISTANCE

17" 66" STEEL BLADE
 BEST FOR BIG JOBS YEAR AFTER YEAR

BUILD YOUR PLOW SYSTEM	STEP 1 SELECT A MOUNT	STEP 2 SELECT A FRAME	STEP 3 SELECT PLOW CONFIGURATION		STEP 4 SELECT A BLADE
MODELS	MOUNT	FRAME	HYDRAULICS	WINCH	BLADES
570 FULL-SIZE '16-22 CREW 570 FULL-SIZE '16-22 500 '10-22 570/CREW 570 '10-21 LI-ION EV & EV '15-22	2880261 \$339 ⁹⁹	<small>TOP SELLER</small> 2880260 \$609 ⁹⁹ Track Extension 2880267 \$339 ⁹⁹	Glacier Pro HD Plow Hydraulic Angle System 2885104 \$799 ⁹⁹ Power Controller 2879227 \$59 ⁹⁹ NO SHIFTER TO MOUNT CONTROLLER ON EV REQUIRED FOR HYDRAULIC COMPONENTS	Polaris Pro HD 4,500 lb. Winch 2882238 \$1,099 ⁹⁹	<small>TOP SELLER</small> 72" Steel 2880270 \$609 ⁹⁹ 66" Poly 2880269 \$539 ⁹⁹ <small>TOP SELLER</small> 66" Steel 2880268 \$469 ⁹⁹
SP 570/CREW SP 570 '22	NEW 2889577 \$209 ⁹⁹ <small>FALL AVAILABILITY</small> NEW 2889195 \$209 ⁹⁹ <small>WINTER AVAILABILITY</small> NOT REQUIRED ON PREMIUM AND NORTHSTAR EDITION MODELS	Replacement Shear Pin 2205527 \$10 ⁹⁹		Polaris Pro HD 4,500 lb. Winch 2885096 \$1,099 ⁹⁹ <small>FALL AVAILABILITY</small>	

BUILD A PLOW SYSTEM

CHOOSE A PLOW SYSTEM

COMMON

3-SEAT & CREW / 2-SEAT & CREW

CONNECTED TECHNOLOGY

ELECTRICAL ACCESSORIES

COOLERS

HUNT

COLD WEATHER

PLOWS

LIGHTING

WHEELS & TIRES

GLACIER[®] HD PLOW SYSTEM

MAKE QUICK WORK OF THE SMALLER JOBS

Move some snow with the sturdy and capable Glacier HD plow system, and discover why a major snowfall can be the highlight of your week. With a robust frame, beefy poly and steel blade options, convenient Lock & Ride mounting and dismounting and amazing value, Glacier HD is a great choice in the dead of winter.



3-SEAT & CREW

» 72" or 66" Blades

» Choice of poly or steel

» Manual angle system standard

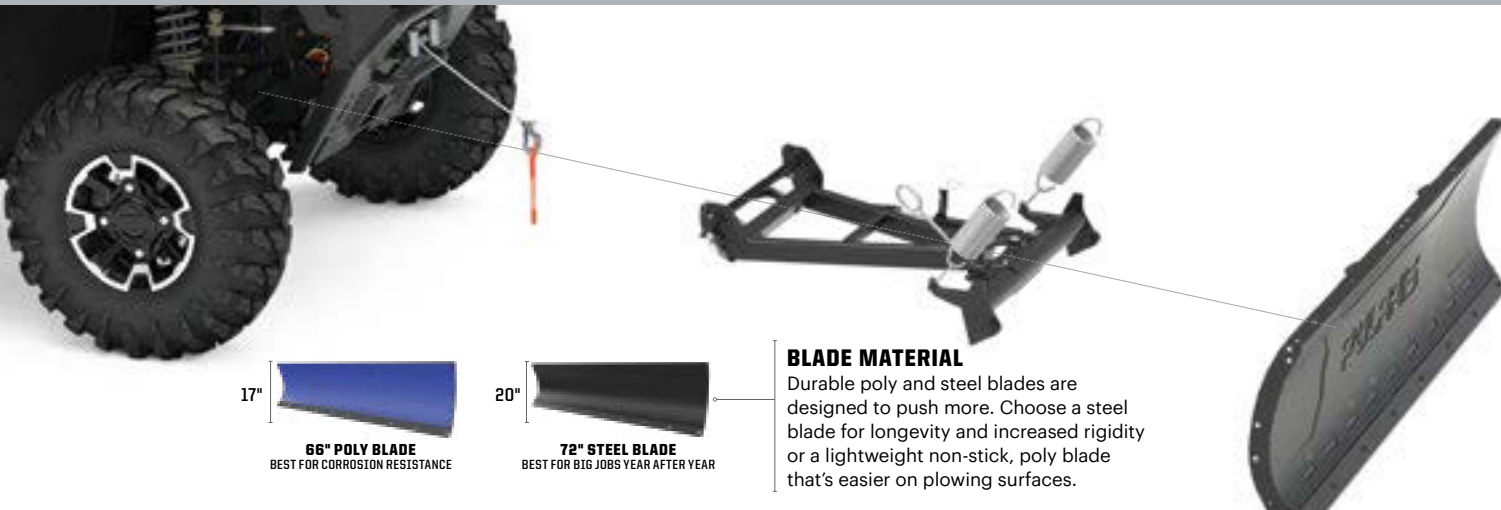

BLADE MATERIAL
Durable poly and steel blades are designed to push more. Choose a steel blade for longevity and increased rigidity or a lightweight non-stick, poly blade that's easier on plowing surfaces.

2-SEAT & CREW 570 FULL-SIZE & CREW

» 66" Blades

» Choice of poly or steel



BUILD A PLOW SYSTEM				
	STEP 1 SELECT A MOUNT	STEP 2 SELECT A FRAME	STEP 3 SELECT A LIFT METHOD	STEP 4 SELECT A BLADE
MODELS	MOUNT	FRAME	WINCHES	BLADES
XP 1000 '18-22 CREW XP 1000 '19-22 1000 '20-22 CREW 1000 '20-22	Not Required Integrated into Factory Brushguard	NEW 2889307 \$609 ⁹⁹ <small>FALL AVAILABILITY</small>	TOP SELLER Polaris HD 4,500 lb. Winch 2882714 \$809 ⁹⁹	TOP SELLER 72" Steel 2880270 \$609 ⁹⁹
<small>NOT COMPATIBLE WITH 29" OR LARGER TIRES</small>	<small>NON EPS RANGER 1000 REQUIRES FRONT BUMPER</small>	Replacement Shear Pin 2205527 \$10 ⁹⁹		66" Poly 2880269 \$539 ⁹⁹
				TOP SELLER 66" Steel 2880268 \$469 ⁹⁹

BUY A PLOW SYSTEM

NEW GLACIER HD PLOW SYSTEM

System includes:
• Frame (2882927)
• 72" Steel Plow (2880270)

» 3880005 • **\$1,212⁹⁹**

XP 1000 '18-22, CREW XP 1000 '19-22, CREW 1000 '20-22, 1000 '20-22
REQUIRES LIFT METHOD: SEE WINCHES AND HYDRAULIC LIFT OPTION

BUILD A PLOW SYSTEM				
	STEP 1 SELECT A MOUNT	STEP 2 SELECT A FRAME	STEP 3 SELECT A LIFT METHOD	STEP 4 SELECT A BLADE
MODELS	MOUNT	FRAME	WINCHES	BLADES
570 FULL-SIZE '16-22 CREW 570 FULL-SIZE '16-22 500/ETX '10-22 570/CREW 570 '10-21 LI-ION EV & EV '15-22	2879105 \$209 ⁹⁹	NEW 2889307 \$609 ⁹⁹ <small>FALL AVAILABILITY</small>	TOP SELLER Polaris HD 3,500 lb. Winch 2881669 \$609 ⁹⁹	66" Poly 2880269 \$539 ⁹⁹
SP 570/CREW SP 570 '22	NEW 2889577 \$209 ⁹⁹ <small>FALL AVAILABILITY</small>	Replacement Shear Pin 2205527 \$10 ⁹⁹	Polaris Pro HD 4,500 lb. Winch 2885096 \$1,099 ⁹⁹ <small>FALL AVAILABILITY</small>	TOP SELLER 66" Steel 2880268 \$469 ⁹⁹
	NEW 2889195 \$209 ⁹⁹ <small>WINTER AVAILABILITY</small>	<small>NOT REQUIRED ON PREMIUM AND NORTHSTAR EDITION MODELS</small>		

BUY A PLOW SYSTEM

NEW GLACIER HD PLOW SYSTEM

System includes:
• Frame (2882927)
• 66" Steel Plow (2880268)

» 3880009 • **\$1,083⁹⁹**

SP 570 '22 & CREW SP 570 '22
REQUIRES LIFT METHOD: SEE WINCHES

SELECT ACCESSORIES

WEAR BARS

- Protect your plow blade and minimize wear on the actual blade
- » 72" • 2204976 • **\$74⁹⁹**
- » 66" • 2879867 • **\$74⁹⁹**
- » 60" • 2877243 • **\$48⁹⁹**
- » HD 72" • 2879875 • **\$139⁹⁹**
- » HD 66" • 2879868 • **\$134⁹⁹**

PLOW BLADE SNOW DEFLECTOR

- » 72" • 2858541 • **\$89⁹⁹**
- » 66" • 2879866 • **\$114⁹⁹**
- » 60" • 2871808 • **\$89⁹⁹**

HEAVY-DUTY SNOW PLOW DEFLECTOR

- » 72" • 2884160 • **\$194⁹⁹**

QUICK RELEASE SKID SHOES

- Helps prevent blade wear
- Hardened steel for industrial strength
- » 2208864 • **\$34⁹⁹**

COIL SPRING SPACER

- Keep the front end of the vehicle up and improve ride quality when using a plow on strut or A-Arm vehicles
- » 2872655 • **\$24⁹⁹**

QUICK RELEASE SKID SHOES

- Helps prevent blade wear
- Hardened steel for industrial strength
- » 2208864 • **\$34⁹⁹**

PLOW MARKER

- Helps driver monitor plow blade position
- Sold in pairs
- » 2872726 • **\$43⁹⁹**

GLACIER PLOW LINK

- » 2204974 • **\$23⁹⁹**

COMMON

3-SEAT & CREW / 2-SEAT & CREW

CONNECTED TECHNOLOGY

ELECTRICAL ACCESSORIES

COOLERS

HUNT

COLD WEATHER

PLOWS

LIGHTING

WHEELS & TIRES



POLARIS ENGINEERED ADVANTAGES

MOUNTS PERFECTLY
Designed for your Polaris Engineered bumper, roof or other mounting point.

MAX PERFORMANCE
Validated to work as hard as your machine does.

DOESN'T OVERTAX
Trust it to work when you need it to.

PRO ARMOR



ADVANCED TECH

RIGID® lights are driven by Aluminum PCB Smart Boards™, 6063-T5 aircraft aluminum extruded housings and Tiger Drylac® UV protection polyester powder-coating.

EXCLUSIVE OPTICS

RIGID® lights feature impact-resistant polycarbonate lenses for a 100% water/dust proof seal.

RIGID® LIMITED LIFETIME WARRANTY

If you own a RIGID® light and it breaks, we will replace or repair it for life.*

RUGGED CONSTRUCTION

Pro Armor lights are designed to be big and beefy with an aggressive style all their own, and housed in IP67 marine-grade rated UV polyester powder coating.

MASSIVELY BRIGHT

Pro Armor builds bright lights designed for any riding experience. All that power is directed through heat dissipating aluminum for streamlined heat management.

LIGHT BAR TYPES



SR-SERIES PRO

Sleek, powerful, low-profile (under 2" tall). Lights extreme distances with low energy usage.
Available in 10" & 32"



D-SERIES PRO

Compact to fit almost anywhere with high output and low energy usage.
Available in Driving, Flood & Spot



DUAL-ROW LED LIGHT BARS

The most spread and farthest illumination downrange. Easy to mount.
Available in Cube, 10", 20" & 30"



SINGLE-ROW LED LIGHT BARS

Powerful, compact, low-profile light bars with sleek look.
Available in 11", 33" & 40"



CUBE LED LIGHTS

Small size allows mounting in strategic locations for added lighting.
Available in Flood & Spot

LIGHT BAR OPTIONS

FOR COMPATIBILITY VISIT POLARIS.COM/ShopRANGER

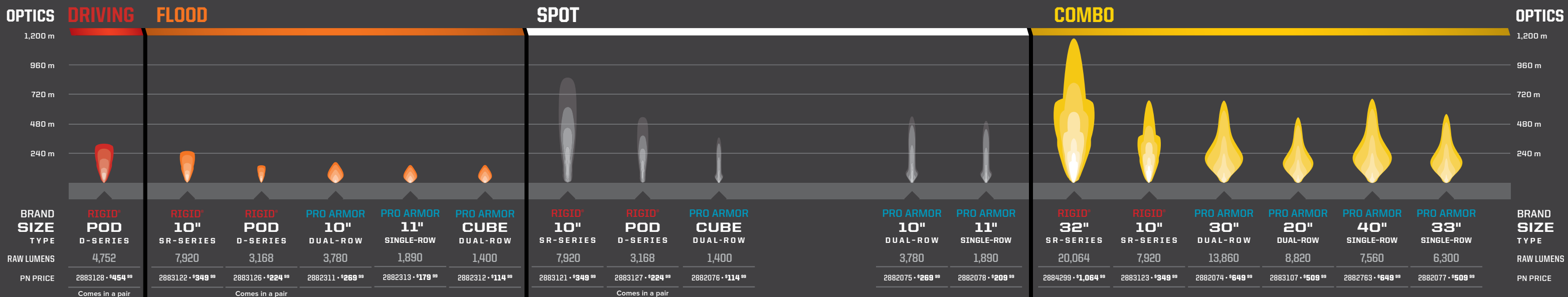

BUILD YOUR VISION

Consider the optics, angle & how you will use your vehicle to choose the right light or set of lights.

OPTICS LIGHT ANGLE	ACCENT	DRIVING (45°)	FLOOD (25°)	SPOT (10°)	COMBO (25°/10°)
DRIVING SPEED	All	Slow	Medium	Fast	Medium to fast
BEAM	Diffused glow	Extra-wide	Wide/Shorter	Concentrated/Long	Inner spot & outer flood
RECOMMENDED MOUNTING	Low/Wheel well	All points	Low &/or rear	High points	All points
TERRAIN & RIDING STYLE	Added style & personalization in any terrain	All riding & utility	Wide-open terrain or trails & utility	Trail & tight conditions	All riding & utility

COMPARE LIGHTS IN A REAL WORLD SETTING AT POLARIS.COM/LIGHTING

* If RIGID® determines, in its sole discretion, that your product is defective in material or workmanship, RIGID® will honor your warranty claim. In some cases the product will be replaced, depending on the specific time frame of the purchase. If the product is repaired, all parts, labor, and return shipping may be covered by RIGID®.

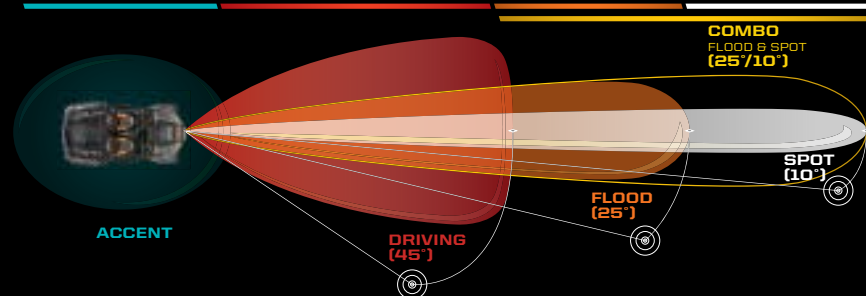

ADD A HARNESS TO MOUNT YOUR LIGHTS

MODEL	LIGHT BAR SET-UPS		
	1 LIGHT IN 1 LOCATION ON 1 SWITCH	2 LIGHTS IN 2 LOCATIONS ON 1 SWITCH	2 LIGHTS IN 2 LOCATIONS ON 2 SWITCHES
EV '15-22, CREW 570-4 '15-21, CREW 570 FULL SIZE '17-22, 570 '15-21, 500 '17-22	Requires Battery Connection Cable TOP SELLER LIGHT BAR HARNESS 2882209 • \$111 ⁹⁹	Requires Battery Connection Cable TOP SELLER LIGHT BAR HARNESS 2882209 • \$111 ⁹⁹ Y-HARNESS 2879860 • \$23 ⁹⁹	Requires Battery Connection Cable TOP SELLER LIGHT BAR HARNESS (x2) 2882209 • \$111 ⁹⁹
SP 570 '22 NON-PREMIUM AND NON-NORTHSTAR MODELS REQUIRE BATTERY CONNECTION CABLE	SEE P. 44 FOR PULSE WIRING CONNECTIONS		
XP 1000 '18-21, CREW XP 1000 '19-21, 1000 '20-21 & CREW 1000 '20-21			

If installing Rear Facing Light on Crew models, use 2883854

1 LED LIGHT BAR WIRING HARNESS - REAR FACING CREW EXTENSION

» 2883854 • **\$25**⁹⁹
XP 1000 '20-22, CREW XP 1000 '19-22, CREW 1000 '20-22

BATTERY CONNECTION CABLES
3-SEAT & CREW 2-SEAT & CREW

- » 3-SEAT • 2879388 • **\$25**⁹⁹
XP 1000 '17
- » CREW • 2879685 • **\$74**⁹⁹
CREW XP 1000 '17-18
- » **TOP SELLER**
2-SEAT • 2879990 • **\$44**⁹⁹
EV '15-22, 570 '15-21, 500 '17-22
- » CREW • 2880929 • **\$72**⁹⁹
CREW 570-4 '15-21
- » 570 • 2881684 • **\$43**⁹⁹
EV '15-22, 570 '15-21, 500 '17-22
- » SP 570 • 2889185 • **\$109**⁹⁹
SP 570 SPORT '22, CREW SP 570 SPORT '22

ADD A BEACON LIGHT FOR 360° ILLUMINATION

P. 27



COMMON

3-SEAT & CREW / 2-SEAT & CREW

CONNECTED TECHNOLOGY

ELECTRICAL ACCESSORIES

COOLERS

HUNT

COLD WEATHER

PLANS

LIGHTING

WHEELS & TIRES

57

KNOW YOUR TERRAIN



- Tread patterns optimized for extreme traction
- Ideal for both hard pack and loose trail



- Flexible "grippy" tread
- Aggressive side bite



- Provides traction and durability
- Built to perform in hard sand, jagged rocks or any other extreme terrain



- Extra deep treads
- Self-cleaning lugs



- Paddles provide traction and durability in soft sand
- Built to float on top of sand



- Triple-belted sidewalls to resist puncture
- Purpose-built, long lasting tread patterns



- Handles extreme cold
- Holds shape and provides traction

SUPERIOR PERFORMANCE & DURABILITY

WAYS TO SHOP WHEELS & TIRES

PRO ARMOR



LIFELONG PERFORMANCE

- Every tire is designed and constructed with longevity in mind
- 3,000+ mile rated ((4,828 kilometers)

PREMIUM PROTECTION

- Pro Armor makes tires with extra protection exactly where it's needed most – the sidewall
- Triple-belted sidewalls keep your tires more resistant so you can keep going

TOUGH TIRES

- Higher ply ratings mean added protection
- Pro Armor builds 8 or 10-ply rated tires for higher puncture-resistance

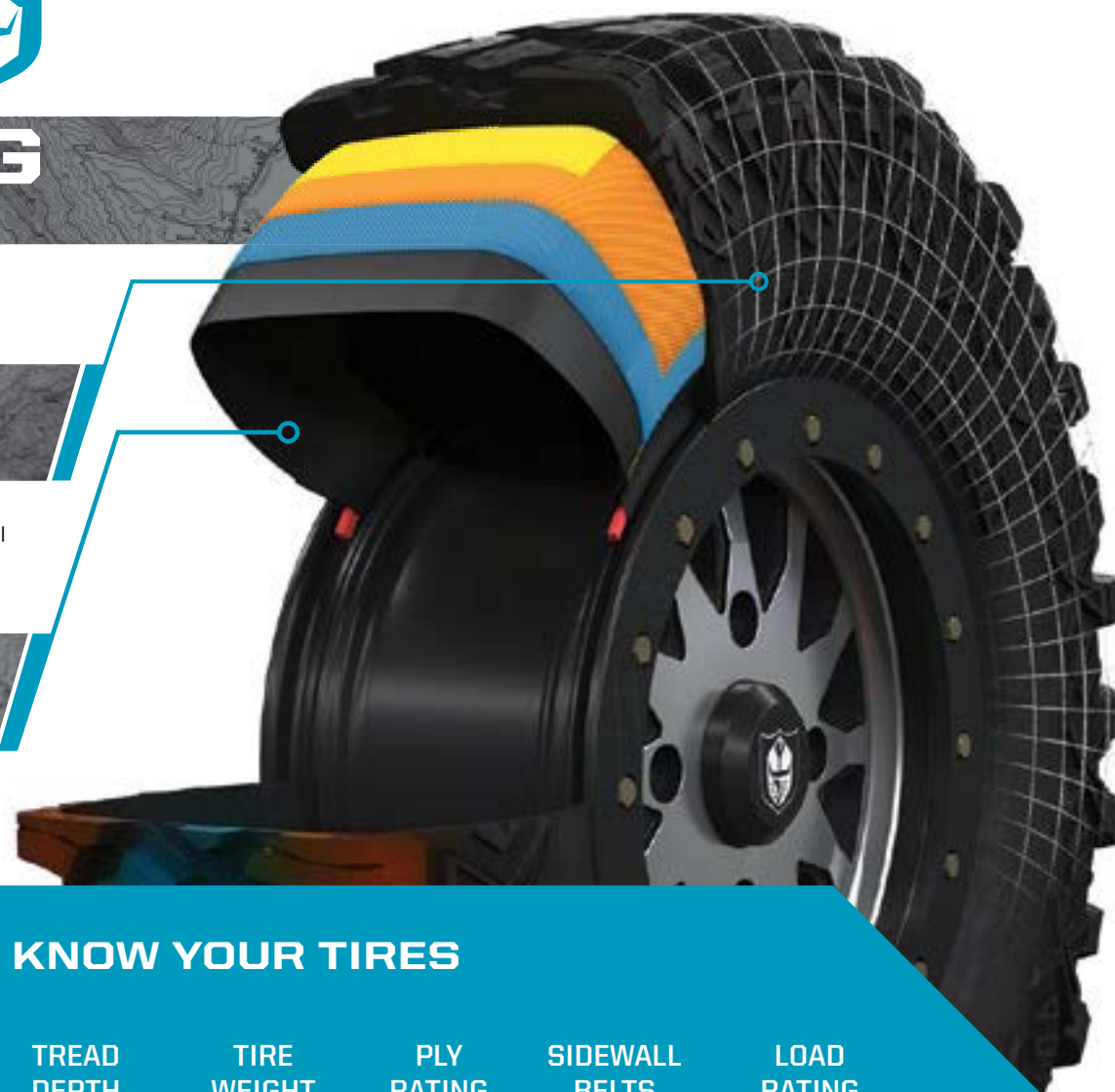

KNOW YOUR TIRES

DIMENSIONS			TREAD DEPTH	TIRE WEIGHT	PLY RATING	SIDEWALL BELTS	LOAD RATING
TIRE HEIGHT	TIRE WIDTH	WHEEL DIAMETER					
32" x 9"	R15	FRONT/REAR	30 mm	41 lbs	10	3	1,320 lbs
Part Number • Price							
USAGE Where can you use the tire			TREAD DEPTH Deeper treads have more grip in all conditions	TIRE WEIGHT A lighter tire makes for improved vehicle performance	PLY RATING Indicates tire puncture-resistance	SIDEWALL BELTS Increase your resistance to sidewall punctures	LOAD RATING How much weight can the tire handle

TIRES BY SIZE

26"	27"	28"	29"
PRESERVE	PRESERVE	HARVESTER	HD-K
HARVESTER	HARVESTER	CRAWLER XR	MUD XC
XD-K	MUD XC	CRAWLER XG	DUAL-THREAT
DUAL-THREAT		ATTACK 2.0	
ATTACK			

TIRES BY TERRAIN



TRAIL	ROCK	DESERT	MUD	UTILITY	SNOW
HARVESTER	CRAWLER XR	CRAWLER XR	MUD XC	HARVESTER	HARVESTER
PRESERVE	CRAWLER XG	CRAWLER XG		PRESERVE	XD-K
XD-K	DUAL-THREAT	ATTACK		XD-K	ATTACK
CRAWLER XR		ATTACK 2.0		HD-K	ATTACK 2.0
CRAWLER XG		DUAL-THREAT			HD-K
MUD XC					
ATTACK					
ATTACK 2.0					
DUAL-THREAT					
HD-K					

WHEELS BY SIZE

14"	15"
40-SERIES (7 TIRE OPTIONS)	50-SERIES (2 TIRE OPTIONS)
4201	5201
4202	5202
4203 BEADLOCK	5203 BEADLOCK
4204	5204
4205	5301 BEADLOCK
4301 BEADLOCK	
HD DUAL BEADLOCK	

KNOW YOUR WHEELS

STEP 1: SELECT YOUR SERIES

4 = 40-SERIES 5 = 50-SERIES

STEP 2: CHOOSE YOUR LOAD RATING

1 = <800 lbs 2 = 801 - 1,300 lbs 3 = 1,301 - 1,600+ lbs

STEP 3: PICK YOUR STYLE

OFFSET / BEADLOCK / COLOR

INCREASE OFFSET FROM STOCK = NARROWER STANCE
DECREASE OFFSET FROM STOCK = WIDER STANCE

COMMON

3-SEAT & CREW / 2-SEAT & CREW

CONNECTED TECHNOLOGY

ELECTRICAL ACCESSORIES

COOLERS

HUNT

COLD WEATHER

PLANS

LIGHTING

WHEELS & TIRES

TIRES

THE RIGHT TIRES

FOR WORK. Pro Armor Utility Tires are built to provide exactly what you need for your application. Looking for a high-kilometer work horse? We've got it. How about a turf-friendly tire with low-impact? We've got those too. Wanting the most extreme puncture resistance? Check.

"We use our RANGER every day around the farm. We put the Pro Armor HARVESTER Tires on last fall and love them! We have received better traction as well as a gentler and quieter ride compared to the stock tires, whether around the yard or out to the fields. They are so gentle on the lawn; we don't worry about driving the kids anywhere around the farm. We've had them on for a year and can't even see wear and tear. These are the best tires for my RANGER."

Bob S. - Barron, Wisconsin



PRO ARMOR HARVESTER

- All-around work horse with tread life of 5,000 miles / 8047 km
- Tread pattern designed to withstand anything from the farmyard to the pastures and the trail
- With 10-ply, it can carry the load day in and day out

			TREAD DEPTH	TIRE WEIGHT	PLY RATING	SIDEWALL BELTS	LOAD RATING
12"	26" x 8" R12 5416396 • \$229 ⁹⁹	FRONT	16 mm	24 lbs	10	3	855 lbs
12"	26" x 10" R12 5415966 • \$249 ⁹⁹	REAR		32 lbs			855 lbs
14"	27" x 10" R14 5415965 • \$249 ⁹⁹	FRONT/REAR		32 lbs			1,320 lbs
14"	28" x 10" R14 5416347 • \$269 ⁹⁹	FRONT/REAR		34 lbs			1,320 lbs



PRO ARMOR XD-K

- 26" Aramid fiber-belted tire to tackle any terrain
- Unique full-face tread design
- Harder durometer lugs promotes extended wear, increasing tire life

			TREAD DEPTH	TIRE WEIGHT	PLY RATING	SIDEWALL BELTS	LOAD RATING
12"	26" x 9" R12 5415756 • \$278 ⁹⁹	FRONT	31.7 mm	28 lbs	10	3/1 Aramid Fiber Belt	855 lbs
12"	26" x 11" R12 5415757 • \$293 ⁹⁹	REAR		32 lbs			1,100 lbs



PRO ARMOR PRESERVE

- Turf-friendly for areas where low-impact from tire tread is needed
- Rounded profile and special tread pattern to limit footprint

			TREAD DEPTH	TIRE WEIGHT	PLY RATING	SIDEWALL BELTS	LOAD RATING
12"	26" x 8" R12 5416403 • \$229 ⁹⁹	FRONT	16 mm	24 lbs	10	3	855 lbs
12"	26" x 10" R12 5416402 • \$249 ⁹⁹	REAR		28 lbs			1,320 lbs
14"	27" x 10" R14 5416348 • \$249 ⁹⁹	FRONT/REAR		28 lbs			1,390 lbs



PRO ARMOR HD-K

- Designed to provide a smooth ride and aggressive traction in all riding terrains
- Triple-belted sidewall provides extreme protection and extends the tire life
- Quad belt tread core offers superior protection and longer tread life

			TREAD DEPTH	TIRE WEIGHT	PLY RATING	SIDEWALL BELTS	LOAD RATING
14"	29" x 10" R14 5417507 • \$439 ⁹⁹	FRONT/REAR	31.75 mm	40 lbs	10	3/1 Aramid	1,320 lbs



COMMON

3-SEAT & CREW / 2-SEAT & CREW

CONNECTED TECHNOLOGY

ELECTRICAL ACCESSORIES

COOLERS

HUNT

COLD WEATHER

PLUGS

LIGHTING

WHEELS & TIRES

TIRES



PRO ARMOR CRAWLER XR

- Premium grip for all terrains, from the trail to the rocks
- Square block profile for even surface contact
- A tougher durometer than the XG to take on the toughest the trail has to offer

		TREAD DEPTH	TIRE WEIGHT	PLY RATING	SIDEWALL BELTS	LOAD RATING	
14"	28" x 10" R14 5415536 • \$259 99	FRONT/REAR	16 mm	32 lbs	8	3	1,140 lbs



XR

SINGLE DUROMETER

- Smaller lug height, added rigidity and lateral stability when cornering
- Unique lug design excels in hard pack, fast terrain



PRO ARMOR DUAL-THREAT

- Dual-compound technology and radial construction offer performance in all terrains
- Softer durometer rubber on outer edge for overall superior grip and feel
- Harder durometer rubber in the middle for increased traction during acceleration and longer tread life

		TREAD DEPTH	TIRE WEIGHT	PLY RATING	SIDEWALL BELTS	LOAD RATING
14"	26" x 9" R14 5416340 • \$219 99	FRONT	16 mm	10	3	910 lbs
14"	26" x 11" R14 5416341 • \$229 99	REAR				1,110 lbs
14"	29" x 9" R14 5416342 • \$269 99	FRONT	16 mm	10	3	1,110 lbs
14"	29" x 11" R14 5416343 • \$279 99	REAR				1,320 lbs



DUAL-COMPOUND = MORE GRIP + LONGER LIFE

Firmer Durometer Rubber = Longer Life



Softer Durometer Rubber = More Grip



PRO ARMOR CRAWLER XG

- Built to crawl over all obstacles, both large and small
- A soft, sticky compound makes this tire ideal for both rock crawling and desert running
- 8-ply, triple-belted ballistic sidewalls resist punctures

		TREAD DEPTH	TIRE WEIGHT	PLY RATING	SIDEWALL BELTS	LOAD RATING	
15"	28" x 10" R15 5416346 • \$269 99	FRONT/REAR	20 mm	32 lbs	8	3	1,110 lbs



WHAT CRAWLER ARE YOU?

XG

DUAL-DUROMETER

- Taller lug height and dual-durometer construction
- Perfect balance between high-speed performance, durability and flex in order to grip slick rock



PRO ARMOR ATTACK 2.0

- Engineered for excellent hard pack performance
- Dual-compound technology and radial construction offer performance in all terrains.
- Tight tread pattern for quieter ride

		TREAD DEPTH	TIRE WEIGHT	PLY RATING	SIDEWALL BELTS	LOAD RATING	
15"	28" x 10" R15 5416344 • \$269 99	FRONT/REAR	25 mm	32 lbs	10	3	1,110 lbs



TIGHTER TREAD PATTERN =
Better traction in hard pack

DUAL-DUROMETER LUG =
Increased grip & traction in rough terrain, smoother ride in all terrain

10-PLY RATED =
Increased durability

LARGER SIZE OFFERING IN 28" =
More ground clearance & trail traction



PRO ARMOR MUD XC

- Designed as the perfect mud-trail crossover for a smooth ride on the trail and aggressive traction in the mud
- Dual-compound technology with harder durometer lugs promote extended wear, increasing tire life
- 10-ply construction means added protection in the toughest terrain

		TREAD DEPTH	TIRE WEIGHT	PLY RATING	SIDEWALL BELTS	LOAD RATING
14"	27" x 9" R14 5416947 • \$249 99	FRONT	30 mm	10	3	1,170 lbs
14"	27" x 11" R14 5416948 • \$259 99	REAR				1,320 lbs
14"	29" x 10" R14 5416946 • \$269 99	FRONT/REAR	39 lbs		3	1,390 lbs



PRO ARMOR ATTACK

- The best all-purpose tire for all-season traction in any terrain
- Unique, full-face tread design
- Harder durometer lugs promote extended wear, increasing tire life
- Wider spaced lugs provide more grip in softer terrain

		TREAD DEPTH	TIRE WEIGHT	PLY RATING	SIDEWALL BELTS	LOAD RATING
14"	26" x 9" R14 5415613 • \$189 99	FRONT	23 mm	8	3	910 lbs
14"	26" x 11" R14 5415614 • \$209 99	REAR				1,320 lbs





• Tread patterns optimized for extreme traction
• Ideal for both hard pack and loose trail



• Flexible "grippy" tread
• Aggressive side bite



• Provides traction and durability
• Built to perform in hard sand, jagged rocks or any other extreme terrain



• Extra deep treads
• Self-cleaning lugs



• Paddles provide traction and durability in soft sand
• Built to float on top of sand



• Triple-belted sidewalls to resist puncture
• Purpose-built, long lasting tread patterns



• Handles extreme cold
• Holds shape and provides traction

WHEEL & TIRE SETS

↑
14"
↓

40-SERIES

UTILITY

DESERT/ROCK

MUD/TRAIL

	HARVESTER 27" 5,000 Mi/8,047 km	HARVESTER 28" 5,000 Mi/8,047 km	PRESERVE 27" 5,000 Mi/8,047 km	CRAWLER XR 28" 3,000 Mi/4,828 km	MUD XC 27" 3,000 Mi/4,828 km	MUD XC 29" 3,000 Mi/4,828 km
4201 Accent	2882388 \$1,739 ⁹⁹	2883225 \$1,859 ⁹⁹	2883208 \$1,599 ⁹⁹	2882394 \$1,739 ⁹⁹	2884272 \$1,739 ⁹⁹	2884265 \$1,849 ⁹⁹
4201 Matte Black	2882389 \$1,599 ⁹⁹	2883226 \$1,739 ⁹⁹	2883209 \$1,599 ⁹⁹	2882395 \$1,599 ⁹⁹	2884273 \$1,612 ⁴⁹	2884266 \$1,715 ⁹⁹
4202 Accent	2882383 \$1,739 ⁹⁹	2883220 \$1,859 ⁹⁹	2883203 \$1,739 ⁹⁹	2881343 \$1,739 ⁹⁹	2884267 \$1,739 ⁹⁹	2884260 \$1,849 ⁹⁹
4202 Matte Black	2882384 \$1,599 ⁹⁹	2883221 \$1,739 ⁹⁹	2883204 \$1,599 ⁹⁹	2881344 \$1,599 ⁹⁹	2884268 \$1,612 ⁴⁹	2884261 \$1,715 ⁹⁹
4203 BEADLOCK Matte Black BEADLOCKS SOLD SEPARATELY				2881386 \$1,999 ⁹⁹		
4204 Accent	2882385 \$1,739 ⁹⁹	2883222 \$1,859 ⁹⁹	2883205 \$1,739 ⁹⁹	2881355 \$1,739 ⁹⁹	2884270 \$1,739 ⁹⁹	2884263 \$1,799 ⁹⁹
4204 Matte Black	2882386 \$1,599 ⁹⁹	2883223 \$1,739 ⁹⁹		2881356 \$1,599 ⁹⁹	2884271 \$1,612 ⁴⁹	2884264 \$1,679 ⁹⁹
4205 Luster				2881371 \$1,739 ⁹⁹		
4205 Matte Black	2882387 \$1,599 ⁹⁹	2883224 \$1,739 ⁹⁹	2883207 \$1,599 ⁹⁹	2881372 \$1,599 ⁹⁹	2884269 \$1,599 ⁹⁹	2884262 \$1,679 ⁹⁹
4301 BEADLOCK Accent BEADLOCKS PRE-MOUNTED				2883213 \$2,139 ⁹⁹		
4301 BEADLOCK Matte Black BEADLOCKS PRE-MOUNTED				2883212 \$1,999 ⁹⁹		

↑
15"
↓

50-SERIES

TRAIL

DESERT/ROCK

	ATTACK 2.0 28" 3,000 Mi/4,828 km	CRAWLER XG 28" 3,000 Mi/4,828 km
5201 Accent	2883160 \$1,799 ⁹⁹	2883188 \$1,799 ⁹⁹
5201 Matte Black	2883159 \$1,669 ⁹⁹	2883187 \$1,669 ⁹⁹
5202 Accent	2883158 \$1,799 ⁹⁹	2883186 \$1,799 ⁹⁹
5202 Matte Black	2883157 \$1,669 ⁹⁹	2883185 \$1,669 ⁹⁹
5203 BEADLOCK Accent BEADLOCKS SOLD SEPARATELY	2883154 \$2,059 ⁹⁹	2883182 \$2,059 ⁹⁹
5204 Matte Black	2883155 \$1,669 ⁹⁹	2883183 \$1,669 ⁹⁹
5301 BEADLOCK Accent BEADLOCKS PRE-MOUNTED	2883162 \$2,169 ⁹⁹	2883190 \$2,169 ⁹⁹
5301 BEADLOCK Matte Black BEADLOCKS PRE-MOUNTED	2883161 \$2,059 ⁹⁹	2883189 \$2,059 ⁹⁹

2 WAYS TO PURCHASE

INDIVIDUAL WHEELS & TIRES
- OR -
COMPLETE SETS AS LISTED

visit Polaris.com/ProArmorRANGER
TO BUILD YOUR CUSTOM SET & VERIFY FITMENT

Exclusively at Polaris Authorized Dealers
or Polaris.com/ProArmorRANGER

BACKCOUNTRY/TRAIL

DUAL-THREAT 26" 3,000 Mi/4,828 km	DUAL-THREAT 29" 3,000 Mi/4,828 km	ATTACK 26" 3,000 Mi/4,828 km
2883138 \$1,669 ⁹⁹	2883146 \$1,859 ⁹⁹	2882390 \$1,489 ⁹⁹
2883139 \$1,539 ⁹⁹	2883147 \$1,739 ⁹⁹	2882391 \$1,359 ⁹⁹
2883140 \$1,699 ⁹⁹	2883148 \$1,859 ⁹⁹	2881335 \$1,599 ⁹⁹
2883141 \$1,539 ⁹⁹	2883149 \$1,739 ⁹⁹	2881336 \$1,479 ⁹⁹
		2881381 \$1,669 ⁹⁹
2883142 \$1,699 ⁹⁹	2883150 \$1,859 ⁹⁹	2881347 \$1,599 ⁹⁹
2883143 \$1,539 ⁹⁹	2883151 \$1,739 ⁹⁹	2881348 \$1,479 ⁹⁹
		2881359 \$1,599 ⁹⁹
2883144 \$1,539 ⁹⁹	2883152 \$1,739 ⁹⁹	2881360 \$1,479 ⁹⁹
2883217 \$2,059 ⁹⁹	2883219 \$2,269 ⁹⁹	
2883216 \$1,939 ⁹⁹	2883218 \$2,139 ⁹⁹	

REPLACEMENT CAPS

POLARIS CAPS

LUSTER	ALL WHEELS EXCEPT 5204 & 5203 BEADLOCK	1521509-410 • \$15 ⁹⁹
MATTE BLACK		1521509-521 • \$15 ⁹⁹
LUSTER	5203 BEADLOCK	1522243-410 • \$30 ⁹⁹
MATTE BLACK		1522243-458 • \$30 ⁹⁹
HD MATTE BLACK	ALL WHEELS	5457498-458 • \$29 ⁹⁹

PRO ARMOR CAPS

LUSTER	ALL WHEELS EXCEPT 5204 & 5203 BEADLOCK	5453209-410 \$15 ⁹⁹
MATTE BLACK		5453209-458 • \$15 ⁹⁹
MATTE BLACK	5204	1523063-458 • \$13 ⁹⁹
LUSTER		1523015-410 • \$15 ⁹⁹
MATTE BLACK	5203 BEADLOCK	1523015-458 • \$15 ⁹⁹

LUG NUTS

○ LUG NUTS REQUIRED

12mm x 1.5 SPLINED LUG NUTS

16 LUG NUTS WITH WRENCH		2879332 • \$54 ⁹⁹
4 LUG NUTS WITHOUT WRENCH	ALL POLARIS RANGER 3-SEAT & CREW MODELS	2879331 • \$18 ⁹⁹
SPLINED LUG WRENCH		2204966 • \$12 ⁹⁹

3/8" - 24 HEX LUG NUTS

16 HEX LUG NUTS	ALL POLARIS RANGER 570 '20-21 MODELS	2877409 • \$43 ⁹⁹
4 HEX LUG NUTS		2876754 • \$18 ⁹⁹



TIRE SEALANT P. 104

» 946 mL • 2830484 • \$25⁹⁹ » 19 LITERS • 2830486 • \$346⁹⁹

» 3.8 LITERS • 2830485 • \$89⁹⁹ » 19 LITERS, PUMP • 2830487 • \$163⁹⁹

COMMON

3-SEAT & CREW / 2-SEAT & CREW

CONNECTED TECHNOLOGY

ELECTRICAL ACCESSORIES

COOLERS

HUNT

COLD WEATHER

PLOWS

LIGHTING

WHEELS & TIRES

WHEELS



15"

14"

50-SERIES

A 5201
WEIGHT: 17.1 lbs | **LOAD RATING:** 1,300 lbs | **OFFSET:** +4
ACCENT: FRONT/REAR 15" x 7" 1523184-266 \$179⁹⁹
MATTE BLACK: FRONT/REAR 15" x 7" 1523184-458 \$149⁹⁹

B 5202
WEIGHT: 17.8 lbs | **LOAD RATING:** 1,300 lbs | **OFFSET:** +4
ACCENT: FRONT/REAR 15" x 7" 1523102-266 \$179⁹⁹
MATTE BLACK: FRONT/REAR 15" x 7" 1523102-458 \$149⁹⁹

C 5203 BEADLOCK
WEIGHT: 16 lbs | **LOAD RATING:** 1,300 lbs | **OFFSET:** +38
MATTE BLACK: FRONT/REAR 15" x 7" 1522435-458 \$309⁹⁹

D 5204
WEIGHT: 13.5 lbs | **LOAD RATING:** 1,300 lbs | **OFFSET:** +55
MATTE BLACK: FRONT/REAR 15" x 7" 1522550-458 \$249⁹⁹

E 5301 BEADLOCK
WEIGHT: 17 lbs | **LOAD RATING:** 1,600 lbs | **OFFSET:** +38
ACCENT: FRONT/REAR 15" x 7" 1523282 \$299⁹⁹
MATTE BLACK: FRONT/REAR 15" x 7" 1523266 \$269⁹⁹

LUG NUTS
 O LUG NUTS REQUIRED
 SEE P. 65



40-SERIES

F 4201
FRONT WEIGHT: 13 lbs | **LOAD RATING:** 900 lbs | **OFFSET:** +4
REAR WEIGHT: 14 lbs | **LOAD RATING:** 1,300 lbs | **OFFSET:** -9
ACCENT: FRONT 14" x 7" 1522956-266 \$189⁹⁹
 REAR 14" x 8" 1522957-266 \$209⁹⁹
MATTE BLACK: FRONT 14" x 7" 1522956-458 \$169⁹⁹
 REAR 14" x 8" 1522957-458 \$179⁹⁹

G 4202
FRONT WEIGHT: 12.75 lbs | **LOAD RATING:** 900 lbs | **OFFSET:** +4
REAR WEIGHT: 13.5 lbs | **LOAD RATING:** 1,300 lbs | **OFFSET:** -9
ACCENT: FRONT 14" x 7" 1522544-266 \$189⁹⁹
 REAR 14" x 8" 1522545-266 \$209⁹⁹
MATTE BLACK: FRONT 14" x 7" 1522544-458 \$169⁹⁹
 REAR 14" x 8" 1522545-458 \$179⁹⁹

H 4203 BEADLOCK
FRONT WEIGHT: 13 lbs | **LOAD RATING:** 900 lbs | **OFFSET:** +4
REAR WEIGHT: 14.5 lbs | **LOAD RATING:** 1,300 lbs | **OFFSET:** -9
MATTE BLACK: FRONT 14" x 7" 1522238-458 \$279⁹⁹
 REAR 14" x 8" 1522239-458 \$279⁹⁹

I 4204
FRONT WEIGHT: 13 lbs | **LOAD RATING:** 900 lbs | **OFFSET:** +4
REAR WEIGHT: 14 lbs | **LOAD RATING:** 1,300 lbs | **OFFSET:** -9
ACCENT: FRONT 14" x 7" 1522546-266 \$189⁹⁹
 REAR 14" x 8" 1522547-266 \$189⁹⁹
MATTE BLACK: FRONT 14" x 7" 1522546-458 \$169⁹⁹
 REAR 14" x 8" 1522547-458 \$169⁹⁹

J 4205
FRONT WEIGHT: 10.5 lbs | **LOAD RATING:** 900 lbs | **OFFSET:** +4
REAR WEIGHT: 12.5 lbs | **LOAD RATING:** 1,300 lbs | **OFFSET:** -9
MATTE BLACK: FRONT 14" x 7" 1521507-521 \$149⁹⁹
 REAR 14" x 8" 1521508-521 \$169⁹⁹
LUSTER: FRONT 14" x 7" 1521507-410 \$189⁹⁹
 REAR 14" x 8" 1521508-410 \$199⁹⁹

K 4301 BEADLOCK
WEIGHT: 16 lbs | **LOAD RATING:** 1,600 lbs | **OFFSET:** +38
ACCENT: FRONT/REAR 14" x 7" 1523284 \$269⁹⁹
MATTE BLACK: FRONT/REAR 14" x 7" 1523283 \$259⁹⁹

L HD DUAL BEADLOCK
WEIGHT: 40 lbs | **LOAD RATING:** 1,600 lbs | **OFFSET:** +38
MATTE BLACK: FRONT/REAR 14" x 7" 1524022-458 \$359⁹⁹

KNOW YOUR WHEELS

STEP 1:
 SELECT YOUR SERIES

4 = 40-SERIES
5 = 50-SERIES

STEP 2:
 CHOOSE YOUR LOAD RATING

1 = <800 lbs
2 = 801 - 1,300 lbs
3 = 1,301 - 1,600+ lbs

STEP 3:
 PICK YOUR STYLE

OFFSET / BEADLOCK / COLOR

INCREASE OFFSET FROM STOCK
 = **NARROWER STANCE**

DECREASE OFFSET FROM STOCK
 = **WIDER STANCE**

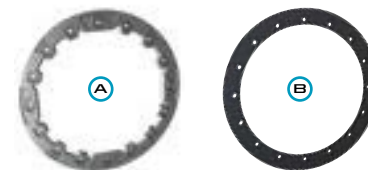

14" FORGED BEADLOCK RINGS

A Machined Only used on 4203 Beadlock & HD Dual Beadlock	1522244-266	\$114 ⁹⁹
B Matte Black - Replacement Only used on 4301 Beadlock & HD Dual Beadlock	1523146-458	\$74 ⁹⁹

15" FORGED BEADLOCK RINGS

A Machined Only used on 5203 Beadlock	1522240-266	\$134 ⁹⁹
B Matte Black - Replacement Only used on 5301 Beadlock	1523147-458	\$79 ⁹⁹

HD PARTS
 P. 100

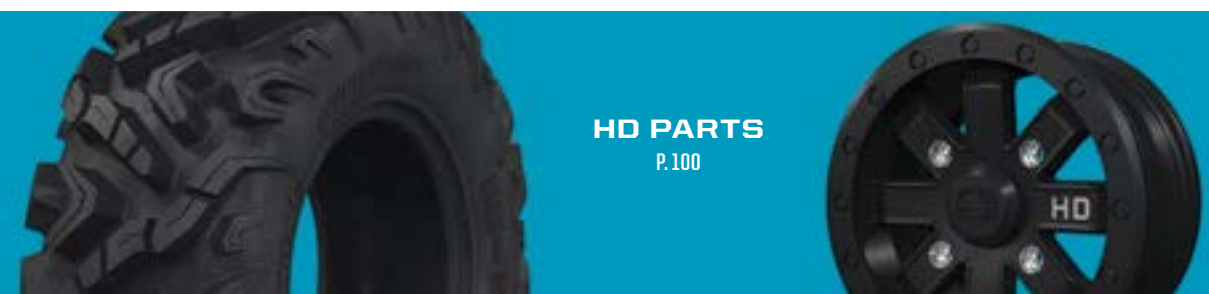

COMMON

3-SEAT & CREW /
 2-SEAT & CREW

CONNECTED
 TECHNOLOGY

ELECTRICAL
 ACCESSORIES

COOLERS

HUNT

COLD WEATHER

PLANS

LIGHTING

WHEELS & TIRES

MAKE IT YOURS

CUSTOMIZE YOUR ALL-NEW RANGER SP 570 AND GET MORE DONE with Polaris Engineered Accessories. Outfit your RANGER based on your riding preferences for added comfort, maximized storage, and more.

SHOP ALL RANGER ACCESSORIES AT [POLARIS.COM/ShopRANGER](https://www.polaris.com/ShopRANGER)

RANGER SP 570 HUNT

2884106	LOCK & RIDE Kolpin Stronghold Auto-Latch Boot Mount	P. 48
2882430	Gun Boot - XL	P. 48
2882077	Pro Armor 33" Combo LED Light Bar	P. 57
2881348	Pro Armor Wheel & Tire Set: Attack & 4204	P. 65
2885078	Poly Crew Sport Roof	P. 70

2889181	Rock Guard with Step - Crew	P. 75
2885087	Rear Brushguard	P. 75
2889056	Polaris Pro HD 4,500 lb. Winch with Rapid Rope Recovery	P. 75
2885088	Front Hood Storage Rack	P. 77



RANGER SP 570 FARM

2883140	Pro Armor Wheel & Tire Set: Dual-Threat & 4202	P. 65
2885077	Poly 2-Seat Sport Roof	P. 70
2889187	Convex Weatherproof Rear View Mirror	P. 74
2889243	Side View Mirrors - ROPS-Mounted	P. 74

2885084	Upper Front Brushguard	P. 75
2885087	Rear Brushguard	P. 75
2885095	Polaris HD 3,500 lb. Winch	P. 75
2889182	LOCK & RIDE Tip-Down Headache Rack	P. 76
2889189	Cargo Bed Mat	P. 76



RANGER SP 570 LANDOWNER

2883144	Pro Armor Wheel & Tire Set: Dual-Threat & 4205	P. 65
2885077	Poly 2-Seat Sport Roof	P. 70
2889187	Convex Weatherproof Rear View Mirror	P. 74
2889243	Side View Mirrors - ROPS-Mounted	P. 74

2889056	Polaris Pro HD 4,500 lb. Winch with Rapid Rope Recovery	P. 75
2889189	Cargo Bed Mat	P. 76
2889199	LOCK & RIDE Storage Box	P. 76



RANGER CREW SP 570 TRAIL

2882077	Pro Armor 33" Combo LED Light Bar	P. 57
2883143	Pro Armor Wheel & Tire Set: Dual-Threat & 4204	P. 65
2885078	Poly Crew Sport Roof	P. 70
2885080	LOCK & RIDE Full Glass Windshield	P. 72
2879965	LOCK & RIDE Rear Panel - Glass	P. 73
2885083	Windshield Wiper & Washer Kit	P. 74

2889187	Convex Weatherproof Rear View Mirror	P. 74
2889243	Side View Mirrors - ROPS-Mounted	P. 74
2889181	Rock Guard with Step - Crew	P. 75
2885084	Upper Front Brushguard	P. 75
2885087	Rear Brushguard	P. 75
2889183	LOCK & RIDE Bed Extender/Divider	P. 76

ROOFS



SEALED COVERAGE

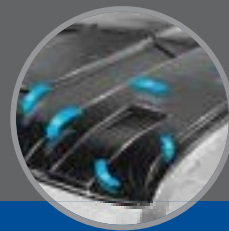

REDUCE STANDING WATER



LOCK & RIDE
EASY AND FAST INSTALLATION

POLARIS ENGINEERED ADVANTAGES

GLASS VS POLY

- Water run-off
- Mounting features: easily add accessories & lighting
- Liner ready
- Lightweight

- Heavy duty/durable
- Low profile
- Unique style

POLY

Lightweight, durable and impact-resistant. A poly roof can take the abuse of a tight trail and still protect.



SPORT ROOF - POLY

- Offers reliable protection from the sun and rain
- Lightweight, durable polyethylene construction
- Simple one-time installation

- » **NEW** 2-SEAT BLACK • 2885077 • **\$389⁹⁹**
SP 570 '22
- » **NEW** CREW BLACK • 2885078 • **\$649⁹⁹**
CREW SP 5770 '22

NEW PREMIUM ROOF LINER

- Cut in-cab noise by 60% at idle and by 40% at 20 mph
- One-piece liner attaches quickly and securely using push darts
- Adds premium comfort and quieter cab ride
- » 2-SEAT (shown) • 2885093 • **\$249⁹⁹**
SP 570 '22
- » CREW • 2885094 • **\$649⁹⁹**
CREW SP 570 '22

STEEL

For the ultimate in strength and protection.

HD ROOF - STEEL

- Stout 12-gauge steel construction
- Powder-coated finish for scratch and corrosion resistance
- Interior fabric liner provides sound reduction

- » 2-SEAT • 2879954 • **\$809⁹⁹**
SP 570 '22



DOORS



PREMIUM FEATURES



UNPRECEDENTED VENTILATION OPTIONS



EASY AND FAST INSTALLATION

POLARIS ENGINEERED ADVANTAGES

POLY DOORS

CANVAS DOORS

	POLY DOORS	CANVAS DOORS
FRONT DOORS (SET OF 2) SP 570 '22, CREW SP 570 '22	<p>CRANK WINDOW Has manual crank windows for airflow adjustment in the cab with a fully finished black interior and exterior panels. Has a steel tube frame with a full 360 degree seal to keep out dust and rain.</p> <p>NEW Manual Crank Window Doors 2885073 • \$2,579⁹⁹ SHOWN WITH EXTERIOR DOOR ACCENT PANEL 2889389-795</p>	<p>ZIP WINDOW Heavy-duty 23-oz durable protection with adjustable zipper ventilation and see-through bottom panel. Powder-coated steel rod door frames provide strength and enhance fit and finish.</p> <p>NEW Zip Window Doors 2885075 • \$1,099⁹⁹ <small>FALL AVAILABILITY</small></p>
REAR DOORS (SET OF 2) CREW SP 570 '22	<p>CRANK WINDOW Has manual crank windows for airflow adjustment in the cab with a fully finished black interior and exterior panels. Has a steel tube frame with a full 360 degree seal to keep out dust and rain.</p> <p>NEW Manual Crank Window Doors 2885074 • \$2,579⁹⁹ SHOWN WITH EXTERIOR DOOR ACCENT PANEL 2889390-795</p>	<p>ZIP WINDOW Heavy-duty 23-oz durable protection with adjustable zipper ventilation and see-through bottom panel. Powder-coated steel rod door frames provide strength and enhance fit and finish.</p> <p>NEW Zip Window Doors 2885076 • \$1,099⁹⁹ <small>FALL AVAILABILITY</small></p>

NEW EXTERIOR DOOR ACCENT PANELS

- Replace stock gloss black accent panels
- Painted plastic and clear-coated for UV protection
- Install easily with a single screw
- Comes as a pair
- Compatible with Poly doors only

Sagebrush Green Non-Metallic	Polaris Pursuit Camo	Polaris Blue Non-Metallic
2889389-560 • \$64⁹⁹ 2889390-560 • \$64⁹⁹	2889391-587 • \$129⁹⁹ 2889392-587 • \$129⁹⁹	2889389-795 • \$64⁹⁹ 2889390-795 • \$64⁹⁹



WINDSHIELDS & REAR PANELS

GLASS VS POLY

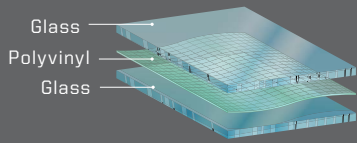

- Superior optical clarity (automotive level)
- Scratch-resistant
- Curved to fit, seals tight
- Cold weather / heavy duty
- Wiper ready (windshield only)

VS

- Lightweight, flexible, easy to store/remove
- Impact-resistant
- Tight seal keeps out rain and dust

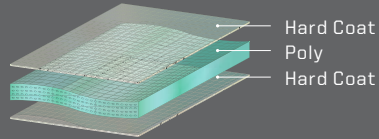

LOCK & RIDE

REVOLUTIONARY INSTALLATION



AIRTIGHT GASKET SEAL



VENTING OPTIONS



MULTI-FUNCTION FEATURES



POLARIS ENGINEERED ADVANTAGES

WINDSHIELDS



Open



NEW FULL TIP-OUT WINDSHIELD - GLASS FALL AVAILABILITY

- Tip-out design offers three positions: open, closed and vented
- Gas shocks assist in easy opening and closing
- 360° gasket for reliable protection and comfort
- Scratch-resistant automotive-style curved glass
- Interior sound dampening and optimized visibility

» 2885079 • \$1,339⁹⁹
SP 570 '22, CREW SP 570 '22



WIPER AVAILABLE
P. 74



NEW FULL GLASS WINDSHIELD - CLEAR

- Scratch-resistant, curved laminate safety glass
- Protects against wind, rain and other hazardous debris
- UV-blocking interlayer and 360° gasket seal

» 2885080 • \$749⁹⁹
SP 570 '22, CREW SP 570 '22



LOCK & RIDE FULL WINDSHIELD - POLY TOP SELLER

- Durable, optical-grade, .236"-thick polycarbonate offers outstanding rider protection and visibility
- Windshield has minimal perimeter framework for full visibility

» 2883318 • \$469⁹⁹
SP 570 '22, CREW SP 570 '22



LOCK & RIDE HALF WINDSHIELD - POLY

- Strong, durable polycarbonate half windshield delivers a combination of protection and airflow into the cab
- Half windshield offers protection from rain, sleet, spray, and off-road hazards

» 2883320 • \$249⁹⁹
SP 570 '22, CREW SP 570 '22



FLIP-DOWN WINDSHIELD - HARD COAT POLY TOP SELLER

- Two venting options: fully sealed or flip-down/remove upper half for some protection with maximum ventilation

» 2882178 • \$649⁹⁹
SP 570 '22



LOCK & RIDE VENTED WINDSHIELD - HARD COAT POLY

- Frameless design for maximum visibility
- Added vents for airflow on a hot day or defrosting on a cold day

» 2883342 • \$709⁹⁹
SP 570 '22, CREW SP 570 '22



LOCK & RIDE FULL WINDSHIELD - HARD COAT POLY TOP SELLER

- Durable, optical-grade, .236"-thick polycarbonate offers outstanding rider protection and visibility
- Windshield has minimal perimeter framework for full visibility

» 2883319 • \$609⁹⁹
SP 570 '22, CREW SP 570 '22



LOCK & RIDE REAR PANEL - GLASS TOP SELLER

- Durable, tempered laminate glass provides a high level of scratch resistance

» 2879965 • \$414⁹⁹
SP 570 '22, CREW SP 570 '22



LOCK & RIDE REAR PANEL - POLY TOP SELLER

- Strong, .236"-thick polycarbonate provides outstanding impact and scratch resistance

» 2879812 • \$339⁹⁹
SP 570 '22, CREW SP 570 '22

HARD COAT POLY | 30x MORE SCRATCH-RESISTANT



REDUCE IN-CAB DUST SWIRL BY ADDING A REAR PANEL

With a windshield and roof installed, turbulent air develops behind the cab. Add a rear panel to reduce dust intrusion from this swirl.

AUDIO

NEW
JBL® DASH AUDIO KIT FALL AVAILABILITY

- System mounts into pre-designated locations in the vehicle dash
- Complete UTV audio solution gives your vehicle a performance-ready sound system
- Includes four off-road grade, water- and dust-proof speakers, and one head unit
- Head unit features AM/FM tuner, USB input and Bluetooth® compatibility for wireless streaming

» 2885081 • **\$899⁹⁹**
 SP 570 '22



POLARIS
RIDECOMMAND SEE P. 42 FOR MORE INFORMATION

7" DISPLAY POWERED BY RIDE COMMAND

» 2884072 • **\$1,999⁹⁹**
 SP 570 '22
 SPEAKERS NOT INCLUDED



CONVENIENCE FEATURES

NEW CAB SEAL KIT

- Seal out dust from your UTV cab
- Reduces dust from getting on dash and seat

» 2889201 • **\$134⁹⁹**
 SP 570 '22, CREW SP 570 '22
(INCLUDED WITH PREMIUM DOORS)

NEW FRONT PULSE BAR AND HARNESS

- This kit is needed to install any electrical accessories to a base vehicle

» 2-SEAT • 2889185 • **\$109⁹⁹**
 SP 570 '22, CREW SP 570 '22

» CREW • 2889568 • **\$109⁹⁹**
 CREW SP 570 '22

NEW HORN KIT

- Adds a warning horn to console area of vehicle

» 2889160 • **\$90⁹⁹**
 SP 570 '22, CREW SP 570 '22

SP 570 NON-PREMIUM AND NON-NORTHSTAR MODELS REQUIRE FRONT PULSE BAR AND HARNESSES 2889185

NEW DOME LIGHT

- LED Dome light provides optimal visibility in the cab
- Easy to install

» 2889159 • **\$139⁹⁹**
 SP 570 '22, CREW SP 570 '22

SP 570 NON-PREMIUM AND NON-NORTHSTAR MODELS REQUIRE FRONT PULSE BAR AND HARNESSES 2889185

NEW FLOOR MATS - FRONT FALL AVAILABILITY

- Protects floors from dirt and wear
- Textured, non-slip surface

» 2889186 • **\$164⁹⁹**
 SP 570 '22, CREW SP 570 '22

SPEEDKEY

» 2879988 • **\$409⁹⁹**
 SP 570 '22, CREW SP 570 '22

CONVENIENCE

FIELD TESTED INTERIOR

ADD SUPERIOR ALL-WEATHER FUNCTIONALITY and comfort to your RANGER with premium Polaris Engineered Accessories. Keep warm on the coldest of days with a heater kit and improve visibility with a Windshield Wiper and Washer System or Large Rear View Mirror.



NEW HEATER KIT FALL AVAILABILITY

- Climate control for the cab of your off-road vehicle
- Total of four dash mounted vents with two positioned for defrosting the windshield and the other two for heating the cab
- Simple, dash-mounted controls
- Manually operated vents for airflow control

» 2885082 • **\$1,289⁹⁹**
 SP 570 '22, CREW SP 570 '22

SP 570 SPORT MODELS REQUIRES FRONT PULSE BAR AND HARNESSES 2889185



NEW WINDSHIELD WIPER & WASHER KIT

- Helps clear hazardous dirt, rain and debris from your windshield

» 2885083 • **\$649⁹⁹**
 SP 570 '22, CREW SP 570 '22

SP 570 SPORT MODELS REQUIRES FRONT PULSE BAR AND HARNESSES 2889185



NEW CONVEX WEATHERPROOF REAR VIEW MIRROR FALL AVAILABILITY

- Convex design for a broader view of traffic
- Durable, weatherproof construction
- Mount the bolts into your choice of pre-designated mounting locations
- Compatible with roof, windshield, and other accessories

» 2889187 • **\$90⁹⁹**
 SP 570 '22, CREW SP 570 '22



NEW SIDE VIEW MIRRORS

» DOOR MOUNTED (shown) • 2889241 • **\$219⁹⁹**

» ROPS-MOUNTED • 2889243 • **\$219⁹⁹**
 SP 570 '22, CREW SP 570 '22

PROTECTION



NEW UPPER FRONT BRUSHGUARD FALL AVAILABILITY

- Made from tubular steel and provides additional protection for front fenders and headlights
- Attaches to stock front bumper
- Durable, scratch-resistant, black powder-coat finish

» 2885084 • **\$339⁹⁹**
 SP 570 '22, CREW SP 570 '22

NEW REAR BRUSHGUARD FALL AVAILABILITY

- Made from tubular steel and provides additional protection for taillights
- Durable, scratch-resistant, black powder-coat finish
- Reliably enhances back-end protection of vehicle

» 2885087 • **\$299⁹⁹**
 SP 570 '22, CREW SP 570 '22

NEW ROCK GUARD WITH STEP

- Reliable, hard-working protection for edges of vehicle
- Mounts directly to the frame, instead of underneath, for maximum ground clearance

» 2-SEAT (shown) • 2889180 • **\$389⁹⁹**
 SP 570 '22

» CREW • 2889181 • **\$519⁹⁹**
 CREW SP 570 '22

NEW A-ARM GUARDS

- Valuable, reliable protection for vital front suspension components exposed to the rigors of off-road environments
- Strong, durable, lightweight polyethylene construction withstands off-road impacts to protect the A-Arms

» WINTER AVAILABILITY FRONT (shown) • 2885097 • **\$269⁹⁹**

» FALL AVAILABILITY REAR • 2880551 • **\$269⁹⁹**
 SP 570 '22, CREW SP 570 '22

WINCHES

FEATURES & BENEFITS	PRO PRO HEAVY DUTY SERIES	HD HEAVY DUTY SERIES	
RAPID ROPE RECOVERY Retrieve cable 5x as fast as standard mode on other Polaris winches. Get back to riding or complete your task quicker.	✓	NOT AVAILABLE	
AUTO STOP TECHNOLOGY Auto Stop technology protects and extends the life of your winch by automatically stopping the winch at the end of pull to prevent over-spooling.	✓	ADD AUTO STOP UPGRADE 2881693 • \$134⁹⁹ <small>SYNTHETIC ROPE REQUIRED</small>	 WARRANTY
SYNTHETIC ROPE Lightweight, extremely strong and flexible 50 ft long rope stands up to any tough job.	✓	ADD SYNTHETIC ROPE 2878888 • \$104⁹⁹	
WIRELESS REMOTE Operate your winch wirelessly from within 50 ft of the vehicle.	WIRELESS STANDARD, WIRED OPTION	WIRED STANDARD, ADD WIRELESS REMOTE 2879316 • \$179⁹⁹	
MODEL	4,500 LB.	3,500 LB.	ADD REQUIRED CABLES
SP 570 '22 CREW SP 570 '22	2885096 \$1,099 ⁹⁹ <small>FALL AVAILABILITY</small>	TOP SELLER 2885095 \$609 ⁹⁹ <small>FALL AVAILABILITY</small>	2-SEAT & CREW MODELS: 2889185 \$109 ⁹⁹

UPGRADE YOUR CONTROLS
 HD OR PRO HD WINCHES

WIRED REMOTE CONTROL

- Must order remote handle and socket together

» REMOTE HANDLE 4013466 • **\$79⁹⁹**

» SOCKET 4014228 • **\$58⁹⁹**

POWER CONTROLLER

- Control your winch and plow hydraulics directly from the shift knob

» 2879227 • **\$59⁹⁹**
 SP 570 '22



STORAGE



LOCK & RIDE®

Exclusive and available on all Polaris vehicles, Lock & Ride accessories let you quickly change from one task to another with hundreds of options.

WITH THE FLIP OF A LEVER, LOCK & RIDE PLUNGERS USE OUTWARD PRESSURE TO EXPAND FOR A SECURE FIT.



NEW LOCK & RIDE STORAGE BOX

- Provides enough room to store all the tools you need to get the job done
 - Internal organizational dividers keep gear from rolling around
 - Easily detaches from vehicle
- » 2889199 • \$439⁹⁹
SP 570 '22, CREW SP 570 '22



NEW LOCK & RIDE TIP-DOWN HEADACHE RACK

- Provides extreme cargo versatility to your UTV
 - Strong steel tube construction for maximum durability
 - Installs and removes easily utilizing Lock & Ride technology
- » 2889182 • \$494⁹⁹
SP 570 '22, CREW SP 570 '22



NEW LOCK & RIDE BED EXTENDER/DIVIDER

- Increase your cargo capacity and UTV storage
 - Extend the cargo bed or divide cargo within the bed
 - Lock & Ride technology for easy install without tools
 - Made from durable steel and powder-coated finish
- » 2889183 • \$324⁹⁹
SP 570 '22, CREW SP 570 '22



NEW CARGO BED MAT

- Protects cargo box, reduces drivetrain noise, and keeps cargo more secure with non-slip design
 - Thick (3.18 mm) rubber mat construction
- » 2889189 • \$155⁹⁹
SP 570 '22, CREW SP 570 '22



NEW LOCK & RIDE FRONT HOOD STORAGE RACK FALL AVAILABILITY

- Increases load-carrying capacity and protects against brush and debris
 - Steel construction with a durable powder-coated finish
 - Lock & Ride functions for easy install, on and off maneuvering of the basket, and under-hood access
 - Weight Capacity: 100 lbs.
- » 2885088 • \$479⁹⁹
SP 570 '22, CREW SP 570 '22

FIRE EXTINGUISHER HOLDER

- Quick-release strap allows for easy access
- » 2882158 • \$114⁹⁹
SP 570 '22, CREW SP 570 '22



RIDE & REPAIR ESSENTIALS KIT

- » 2881207 • \$134⁹⁹
SP 570 '22, CREW SP 570 '22



LOCK & RIDE D-RINGS TOP SELLER

- The most versatile Lock & Ride accessory - add as many as you need to secure your cargo with bungee cords or straps
- » 2881545 • \$43⁹⁹
SP 570 '22, CREW SP 570 '22



LOCK & RIDE CHAINSAW MOUNT

- » 2879354 • \$179⁹⁹
SP 570 '22, CREW SP 570 '22



LOCK & RIDE TOOL RACK

- Attach on the inside or outside of the cargo bed
- » 2881533 • \$329⁹⁹
SP 570 '22, CREW SP 570 '22



STRAPS

1.5" x 15' 5,500 LB. RATCHET STRAP

- Heavy-duty webbing
 - 2 Pack
- » 2884031 • \$59⁹⁹



LOCK & RIDE QUICKSTRAP

- The quickest and most secure way to mount Polaris accessories
 - Sold as a pair
- » 2882187 • \$59⁹⁹
ALL COOLERS, RANGER CARGO BOXES



2" x 20' 10,000 LB. RATCHET STRAP

- Heavy-duty webbing
- » 2884032 • \$43⁹⁹



DO MORE:



COOLERS
P. 46



HUNT
P. 48

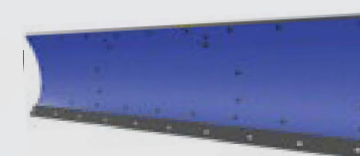

COLD WEATHER
P. 50



LIGHTING
P. 56

RANGER 500 / EV
2015-2021 RANGER 570

MAKE IT YOURS

WORK HARD AND GET IT DONE

with Polaris Engineered Accessories for your RANGER. Start with the ultimate in all-season performance and comfort with the best cab components in the industry. Find everything you need to outfit your RANGER for the task at hand.

RANGER 570 HUNT

2882430	Kolpin Stronghold Gun Boot XL Transport	P. 48
2885077	Poly 2-Seat Sport Roof	P. 80
2881784	LOCK & RIDE Full Tip-Out Windshield - Glass	P. 82
2882238	Polaris Pro HD 4,500 lb. Winch	P. 85



RANGER 570 WORK

2885077	Poly 2-Seat Sport Roof	P. 80
2882247	Hinged Window Doors - Poly	P. 81
2881784	LOCK & RIDE Full Tip-Out Windshield - Glass	P. 82
2882238	Polaris Pro HD 4,500 lb. Winch	P. 85
2881485	Cargo Bed Mat	P. 86



RANGER CREW 570-4 EPS RANCH

2883424	Polaris Northstar Cooler - 30 Quart	P. 46
2885078	Poly Sport Roof - Crew	P. 80
2879963	LOCK & RIDE Canvas Door Set	P. 81
2881783	Glass Full Windshield, Clear	P. 82
2881533	LOCK & RIDE Tool Rack	P. 87



RANGER 500 TRAIL

2883425	Polaris Northstar Cooler - 60 Quart	P. 46
2885077	Poly 2-Seat Sport Roof	P. 80
2883320	LOCK & RIDE Half Windshield - Poly	P. 83

2-SEAT & CREW

500 / EV

ROOFS & DOORS

WINDSHIELDS & REAR PANELS

CONVENIENCE & PROTECTION

WINCHES

STORAGE

SHOP ALL RANGER ACCESSORIES AT
[POLARIS.COM/ShopRANGER](https://www.polaris.com/ShopRANGER)

ROOFS



SEALED
COVERAGE

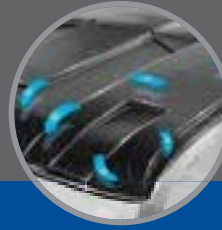

REDUCE
STANDING
WATER



LOCK & RIDE
EASY AND FAST
INSTALLATION

POLARIS ENGINEERED
ADVANTAGES

POLY FEATURES

- Water run-off
- Mounting features: easily add accessories & lighting
- Liner ready
- Lightweight

SHIELD AGAINST DRIVING RAIN OR THE BLISTERING SUN.

Know that you are protected from the elements with a seamless integrated roof. Poly is lightweight, durable and impact-resistant. A poly roof can take the abuse of a tight trail and still protect.



NEW SPORT ROOF - POLY

- Provides shade, superior overhead protection
- Tough injection-molded design resists distortion from the elements
- Polaris Pursuit Camo offers effective visual camouflage in the field

» 2-SEAT BLACK • 2885077 • \$519⁹⁹
EV '15-22, 570 '15-21, 500 '17-22
» CREW BLACK • 2885078 • \$519⁹⁹
CREW 570-4 '15-21

DOORS



PREMIUM
FEATURES





UNPRECEDENTED
VENTILATION
OPTIONS



EASY AND FAST
INSTALLATION

POLARIS ENGINEERED
ADVANTAGES

	POLY DOORS	CANVAS DOORS
FRONT DOORS (SET OF 2) EV '15-22, CREW 570-4 '15-21, 570 '15-21, 500 '17-22	HINGED WINDOW A premium, door offering hinged window for customizable ventilation in the cab.  Hinged Window - Poly Doors - Black 2882247 • \$2,709 ⁹⁹	ZIP WINDOW Lightweight, durable protection with adjustable zipper ventilation and see-through bottom panel.  TOP SELLER Zip Window Doors - Canvas - Black 2879963 • \$1,229 ⁹⁹
REAR DOORS (SET OF 2) CREW 570-4 '15-21		 Zip Window Doors - Rear - Canvas - Black 2879964 • \$1,229 ⁹⁹



WINDSHIELDS & REAR PANELS

GLASS VS POLY

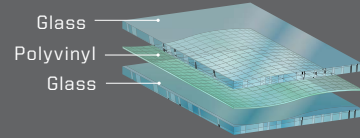

- Superior optical clarity (automotive level)
- Scratch-resistant
- Curved to fit, seals tight
- Cold weather / heavy duty
- Wiper ready (windshield only)

- Lightweight, flexible, easy to store/remove
- Impact-resistant
- Tight seal keeps out rain and dust

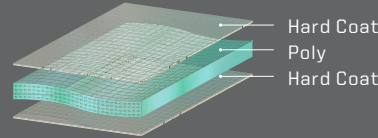

LOCK & RIDE

REVOLUTIONARY INSTALLATION



AIRTIGHT GASKET SEAL



VENTING OPTIONS



MULTI-FUNCTION FEATURES



POLARIS ENGINEERED ADVANTAGES

WINDSHIELDS



LOCK & RIDE TIP-OUT WINDSHIELD - GLASS

- Made of strong, optical-grade laminate safety glass
- Provides optimal visibility and the best protection from wind, inclement weather and off-road hazards
- Minimal perimeter framework for a low profile and full visibility
- Tip-out feature adjusts the windshield to an open position to enjoy airflow in the cab

» 2881784 • \$1,329⁹⁹
EV '15-22, CREW 570-4 '15-21, 570 '15-21, 500 '17-22

FULL WINDSHIELD - GLASS TOP SELLER

- Provides the highest level of scratch resistance

» 2881783 • \$809⁹⁹
EV '15-22, CREW 570-4 '15-21, 570 '15-21, 500 '17-22

LOCK & RIDE FULL WINDSHIELD - POLY TOP SELLER

- Durable, optical-grade, .236"-thick polycarbonate offers outstanding rider protection and visibility
- Windshield has minimal perimeter framework for full visibility

» 2883318 • \$469⁹⁹
EV '15-22, CREW 570-4 '15-21, 570 '15-21, 500 '17-22

LOCK & RIDE HALF WINDSHIELD - POLY

- Strong, durable polycarbonate half windshield delivers a combination of protection and airflow into the cab
- Half windshield offers protection from rain, sleet, spray, and off-road hazards

» 2883320 • \$249⁹⁹
EV '15-22, CREW 570-4 '15-21, 570 '15-21, 500 '17-22

WIPER
AVAILABLE
P. 84



FLIP-DOWN WINDSHIELD - HARD COAT POLY TOP SELLER

- Two venting options: fully sealed or flip-down/remove upper half for some protection with maximum ventilation

» 2882178 • \$649⁹⁹
EV '15-22, CREW 570-4 '15-21, 570 '15-21, 500 '17-22

LOCK & RIDE VENTED WINDSHIELD - HARD COAT POLY

- Frameless design for maximum visibility
- Added vents for airflow on a hot day or defrosting on a cold day

» 2883342 • \$709⁹⁹
EV '15-22, CREW 570-4 '15-21, 570 '15-21, 500 '17-22

LOCK & RIDE FULL WINDSHIELD - HARD COAT POLY TOP SELLER

- Durable, optical-grade, .236"-thick polycarbonate offers outstanding rider protection and visibility
- Windshield has minimal perimeter framework for full visibility

» 2883319 • \$609⁹⁹
EV '15-22, CREW 570-4 '15-21, 570 '15-21, 500 '17-22

LOCK & RIDE REAR PANEL - GLASS TOP SELLER

- Durable, tempered laminate glass provides a high level of scratch resistance

» 2879965 • \$414⁹⁹
EV '15-22, CREW 570-4 '15-21, 570 '15-21, 500 '17-22

LOCK & RIDE REAR PANEL - POLY TOP SELLER

- Strong, .236"-thick polycarbonate provides outstanding impact and scratch resistance

» 2879812 • \$339⁹⁹
EV '15-22, CREW 570-4 '15-21, 570 '15-21, 500 '17-22

HARD COAT POLY | 30x MORE SCRATCH-RESISTANT



REDUCE IN-CAB DUST SWIRL BY ADDING A REAR PANEL

With a windshield and roof installed, turbulent air develops behind the cab. Add a rear panel to reduce dust intrusion from this swirl.

CONVENIENCE & PROTECTION



CONVENIENCE FEATURES

CAB SEAL SYSTEM

» 2-SEAT • 2880508 • **\$159⁹⁹**
EV '15-22, CREW 570-4 '15-21, 570 '15-21, 500 '17-22
(INCLUDED WITH PREMIUM DOORS)

EPS SYSTEM (ELECTRIC POWER STEERING)

- Enjoy smooth, easy, precise, responsive automotive-quality power steering
- EPS provides a light steering feel in all situations, including low-speed maneuvering through challenging terrain

» 2879970 • **\$1,739⁹⁹**
CREW 570-4 '15-21, 570 '15-21
1824163 REQUIRED FOR 2016 AND NEWER 570 MODELS

HORN

» 2879273 • **\$89⁹⁹**
EV '15-22, CREW 570-4 '15-21, 570 '15-21, 500 '17-22

AUXILIARY BATTERY KIT

» 2880555 • **\$409⁹⁹**
EV '15-22
REQUIRED FOR 12V ACCESSORIES ON EV

REVERSE WARNING ALERT

» 2880631 • **\$109⁹⁹**
CREW 570-4 '15-21, 570 '15-21, 500 '17-22

SPEEDKEY

» 2879988 • **\$409⁹⁹**
CREW 570-4 '15-21, 570 '15-21

EV QUICK CHARGING SYSTEM

» 2880556 • **\$809⁹⁹**
EV '15-22

FIELD TESTED INTERIOR

ADD SUPERIOR ALL-WEATHER FUNCTIONALITY and comfort to your RANGER with premium Polaris Engineered Accessories. Keep warm on the coldest of days with a heater kit and improve visibility with a Windshield Wiper and Washer System or Large Rear View Mirror.



WINDSHIELD WIPER & WASHER SYSTEM

- Use with Full Glass Windshield 2881783 only

» 2879968 • **\$749⁹⁹**
EV '15-22, CREW 570-4 '15-21, 570 '15-21, 500 '17-22
⚠ Requires Battery Connection Cable



LARGE REAR VIEW MIRROR TOP SELLER

» 2879969 • **\$94⁹⁹**
EV '15-22, CREW 570-4 '15-21, 570 '15-21, 500 '17-22

STANDARD BRUSHGUARDS

PERFECT FOR: **INCREASED PROTECTION AROUND LIGHTING AND FENDERS**

FRONT



1 3/4" DIAMETER
STEEL TUBE CONSTRUCTION

REAR



» FRONT • 2879973 • **\$339⁹⁹** » REAR • 2879972 • **\$329⁹⁹**
EV '15-22, CREW 570-4 '15-21, 570 '15-21, 500 '17-22
DOES NOT WORK WITH FLIP-DOWN POLY WINDSHIELD 2881919

ROCK GUARDS WITH STEP



- Durable, stamped plate steel construction
- Provides additional protection for side of vehicle
- Integrated boot scraper helps keep interior clean

» 2 SEAT • 2879974 • **\$264⁹⁹**
EV '15-22, 570 '15-21, 500 '17-22

WINCHES

FEATURES	PRO PRO HEAVY DUTY SERIES	HD HEAVY DUTY SERIES	WARRANTY
RAPID ROPE RECOVERY	STANDARD	NOT AVAILABLE	
AUTO STOP TECHNOLOGY	STANDARD	OPTION	
WINCH LINE	SYNTHETIC ROPE	STEEL CABLE	
CONTROL	WIRELESS STANDARD, WIRED OPTION	WIRED STANDARD, WIRELESS OPTION	
MODEL	4,500 LB.	3,500 LB.	ADD REQUIRED CABLES
570 '15-21 CREW 570-4 '15-21 500 '17-22 EV '19-22 EV REQUIRES AUXILIARY BATTERY KIT 2880555	2882238 \$1,099 ⁹⁹	2881669 \$609 ⁹⁹	2-SEAT MODELS: 2879990 \$44 ⁹⁹ CREW MODELS: 2880929 \$72 ⁴⁹

UPGRADE YOUR HD WINCH WITH THESE ACCESSORIES

WIRELESS REMOTE

- Up to 50 ft. range with LED indicator
- Direct plug and play operation

» 2879316 • **\$179⁹⁹**
Works with 2881669

SYNTHETIC ROPE

4,500 LB.
» 2879187 • **\$179⁹⁹**

3,500 LB.
» 2878888 • **\$104⁹⁹**

AUTO STOP UPGRADE

- Billeted aluminum
- Replaces stock fairlead

» 2881693 • **\$134⁹⁹**
Works with 2881669
SYNTHETIC ROPE REQUIRED

UPGRADE YOUR CONTROLS HD OR PRO HD WINCHES

WIRED REMOTE CONTROL

- Must order remote handle and socket together

» REMOTE HANDLE 4013466 • **\$79⁹⁹**
» SOCKET 4014228 • **\$58⁹⁹**

POWER CONTROLLER

- Control your winch and plow hydraulics directly from the shift knob

» 2879227 • **\$59⁹⁹**
CREW 570-4 '14-21, 570 FULL SIZE '17-22, 570 '14-21, 500 '11-22

STORAGE



LOCK & RIDE®

Exclusive and available on all Polaris vehicles, Lock & Ride accessories let you quickly change from one task to another with hundreds of options.

WITH THE FLIP OF A LEVER, LOCK & RIDE PLUNGERS USE OUTWARD PRESSURE TO EXPAND FOR A SECURE FIT.



LOCK & RIDE CARGOMAX SYSTEM

- Comes standard with a support bar that ties the two sides together for a sturdy cargo hold
- Adjustable utility hooks provide more options for hanging tools, cords or gear
- Two sides and a support bar included

» 2882177 • \$749⁹⁹

EV '15-22, CREW 570-4 '15-21, 570 '15-21, 500 '17-22



CARGO BED MAT

- Non-slip surface to better secure loads
- Protect the cargo bed from scratches and scuffs
- Lifts out and is easy to clean
- Can be cut to access factory tie-down cleats

» 2881485 • \$134⁹⁹

EV '11-22, CREW 570-4 '14-21, 570 '14-21, 500 '11-22

LOCK & RIDE STORAGE BOX

- Rugged roto-molded construction locks for security and is water-resistant
- Low-profile design retains additional hauling capacity on top of vault
- Sliding drawer features foam padding and adjustable dividers
- Fits perfectly in the bed of your RANGER, pickup box or full-size SUV

» 2877033 • \$439⁹⁹

EV '11-22, CREW 570-4 '14-21, 570 '14-21, 500 '11-22



LOCK & RIDE TOOL RACK

- Attach on the inside or outside of the cargo bed

» 2881533 • \$329⁹⁹

EV '11-22, CREW 570-4 '14-21, CREW 570 FULL SIZE '18-22, 570 FULL SIZE '17-22, 570 '14-21, 500 '11-22



RIDE & REPAIR ESSENTIALS KIT

» 2881207 • \$134⁹⁹

EV '11-22, CREW 570-4 '14-21, CREW 570 FULL SIZE '18-22, 570 FULL SIZE '17-22, 570 '14-21, 500 '11-22

STRAPS



1.5" x 15' 5,500 LB. RATCHET STRAP

- Heavy-duty webbing
- 2 Pack

» 2884031 • \$59⁹⁹



FIRE EXTINGUISHER HOLDER

- Quick-release strap allows for easy access

» 2882158 • \$114⁹⁹

EV '15-22, CREW 570-4 '15-21, 570 '15-21, 500 '17-22



LOCK & RIDE D-RINGS TOP SELLER

- The most versatile Lock & Ride accessory - add as many as you need to secure your cargo with bungee cords or straps

» 2881545 • \$43⁹⁹

EV '11-22, CREW 570-4 '14-21, CREW 570 FULL SIZE '18-22, 570 FULL SIZE '17-22, 570 '14-21, 500 '11-22



UNDER SEAT STORAGE BOX

» 2880046 • \$134⁹⁹

EV '15-22, CREW 570-4 '15-21, 570 '15-21, 500 '17-22



LOCK & RIDE CHAINSAW MOUNT

» 2879354 • \$179⁹⁹

EV '11-22, CREW 570-4 '14-21, CREW 570 FULL SIZE '18-22, 570 FULL SIZE '17-22, 570 '14-21, 500 '11-22



LOCK & RIDE QUICKSTRAP

- The quickest and most secure way to mount Polaris accessories
- Sold as a pair

» 2882187 • \$59⁹⁹

ALL COOLERS, RANGER CARGO BOXES



2" x 20' 10,000 LB. RATCHET STRAP

- Heavy-duty webbing

» 2884032 • \$43⁹⁹

DO MORE:



COOLERS

P. 46



HUNT

P. 48

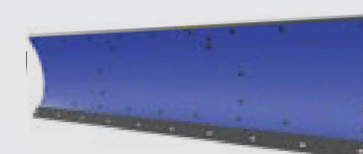

COLD WEATHER

P. 50



LIGHTING

P. 56

PERFORMANCE & COMFORT

THE RANGER 570 FULL-SIZE builds on its legendary reputation for getting the job done. With the industry's most complete lineup of Polaris Engineered Accessories, it's ready for anything your work demands.



DO MORE:



COOLERS
P. 46

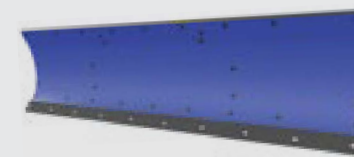

COLD WEATHER
P. 50



HUNT
P. 48



LIGHTING
P. 56

ROOFS



SPORT ROOF

- Lightweight, rugged polyethylene construction
- Offers protection from sun and rain
- Does not work with Full Doors

» **TOP SELLER** 3-SEAT • 2877946 • **\$425⁹⁹**
570 FULL SIZE '17-21
» CREW • 2878755 • **\$709⁹⁹**
CREW 570 FULL SIZE '17-22



BIMINI SOFT TOP

- Tight-fitting canvas soft top with easy on/off design
- Lightweight 600 denier, solution-dyed polyester construction

» 2876963-067 • **\$134⁹⁹**
570 FULL SIZE '17-22

ROOF/REAR PANEL



CANVAS ROOF/REAR PANEL

- Constructed from premium, mold-resistant polyester with UV stabilizers
- Durable, heat-sealed vinyl window for crack resistance

» 2883471 • **\$469⁹⁹**
570 FULL SIZE '17-22

DOORS



RANGER CANVAS DOORS

- Constructed from premium, mold-resistant polyester with UV stabilizers
- Durable, heat-sealed vinyl window for crack resistance
- Zip-down windows for adjustable ventilation

» 2876962-067 • **\$619⁹⁹**
570 FULL SIZE '17-22
REQUIRES 2883471 CANVAS ROOF/REAR PANEL
DOES NOT FIT WITH 2877946 OR 2876963-067

PROTECTION



BRUSHGUARDS

- Provides front impact resistance and headlight protection
- Durable, scratch-resistant black powder-coated finish

» FRONT • 2881662 • **\$299⁹⁹**
CREW 570 FULL SIZE '18-22, 570 FULL SIZE '17-22



HORN

» 2875048 • **\$99⁹⁹**
570 FULL SIZE '17-22

REVERSE BEEPER

» 2880631 • **\$109⁹⁹**
CREW 570-4 '15-21, 570 '15-21, 500 '17-22

WINDSHIELDS



POLY WINDSHIELD

- Optical-grade, .236"-thick polycarbonate for outstanding protection and visibility

» **HARD COAT** • 2879489 • **\$669⁹⁹**
CREW 570 FULL SIZE '18-22, 570 FULL SIZE '17-22
» **TOP SELLER** GENERAL PURPOSE • 2876958 • **\$539⁹⁹**
CREW 570 FULL SIZE '18-22, 570 FULL SIZE '17-22



LOCK & RIDE HALF WINDSHIELD

- Durable, optical-grade, .177"-thick polycarbonate for impact-resistance
- Half-height design delivers improved airflow for hot/dusty conditions
- Retains sporty, rugged look

» 2878756 • **\$269⁹⁹**
CREW 570 FULL SIZE '18-22, 570 FULL SIZE '17-22

REAR PANEL



POLY REAR PANEL

- Constructed from thick, impact resistant polycarbonate
- Delivers protection from the elements and a quieter ride
- Scratch-resistant for years of clear vision
- Contoured design eliminates perimeter framework for full rearward visibility

» 2878165 • **\$339⁹⁹**
CREW 570 FULL SIZE '18-22, 570 FULL SIZE '17-22

WINCHES

FEATURES	PRO PRO HEAVY DUTY SERIES	HD HEAVY DUTY SERIES
RAPID ROPE RECOVERY	STANDARD	NOT AVAILABLE
AUTO STOP TECHNOLOGY	STANDARD	OPTION
WINCH LINE	SYNTHETIC ROPE	STEEL CABLE
CONTROL	WIRELESS STANDARD, WIRED OPTION	WIRED STANDARD, WIRELESS OPTION
MODEL	4,500 LB.	3,500 LB.
570 FULL-SIZE '16-22 CREW 570 FULL-SIZE '16-22	2882238 \$1,099 ⁹⁹	2881669 \$609 ⁹⁹



WARRANTY

ADD REQUIRED CABLES

3-SEAT MODELS:
2881684 \$43⁹⁹
CREW MODELS:
2880929 \$72⁴⁹

UPGRADE YOUR HD WINCH WITH THESE ACCESSORIES

WIRELESS REMOTE

- Up to 50 ft. range with LED indicator
- Direct plug and play operation

» 2879316 • **\$179⁹⁹**
Works with 2881669

SYNTHETIC ROPE

- 3,500 LB.
- » 2878888 • **\$104⁹⁹**
- 4,500 LB.
- » 2879187 • **\$179⁹⁹**

STEEL CABLE

- 3,500 LB.
- » 2878890 • **\$59⁹⁹**

AUTO STOP UPGRADE

- Billeted aluminum
- Replaces stock fairlead

» 2881693 • **\$134⁹⁹**
Works with 2881669

SYNTHETIC ROPE REQUIRED

UPGRADE YOUR CONTROLS HD OR PRO HD WINCHES

WIRED REMOTE CONTROL

- Must order remote handle and socket together

» REMOTE HANDLE 4013466 • **\$79⁹⁹**
» SOCKET 4014228 • **\$58⁹⁹**

POWER CONTROLLER

- Control your winch and plow hydraulics directly from the shift knob

» 2879227 • **\$59⁹⁹**

EV '11-22, CREW 570-4 '14-21, 570 FULL SIZE '17-22, 570 '14-21, 500 '11-22

LOCK & RIDE

ADD STORAGE TO YOUR RANGER 570 P. 76

HIT THE TRAILS RANGER 150 EFI ACCESSORIES



NEW
HALF DOOR WINTER AVAILABILITY

- Steel half doors protect your cab from rocks and debris
- Added comfort with padded elbow guards

» BLACK • 2889022 • **\$519⁹⁹**
150 EFI '18-22



**FRONT & REAR
BRUSHGUARD - SET**

- Includes front and rear bumper
- Durable, E-coated steel construction

» BLACK • 2883287 • **\$134⁹⁹**
150 EFI '18-22



SPORT ROOF - POLY

- Shields you from rain, snow, sun
- Easy install

» BLACK • 2883289 • **\$269⁹⁹**
150 EFI '18-22

YOUTH CRAWLER TIRE

- Upgraded youth tire for added durability
 - Increased ground clearance and performance
- 150 EFI '18-22

	TREAD DEPTH	TIRE WEIGHT	PLY RATING	SIDEWALL BELTS	LOAD RATING	
12" ↑ 22" x 8" R12 5416945 • \$129 ⁹⁹	FRONT/ REAR	13 mm	18 lbs	6	3	910 lbs
12" ↓ 22" x 10" R12 5416944 • \$144 ⁹⁹						



YOUTH BUCKLE - BLACK

- » FRONT • 12" x 7" • 1524114 • **\$119⁹⁹**
 - » REAR • 12" x 8" • 1524115 • **\$129⁹⁹**
- 150 EFI '18-22



**PRO ARMOR WHEEL & TIRE KIT:
YOUTH CRAWLER & BUCKLE**

» 2885154 • **\$959⁹⁹**
150 EFI '18-22



FULL-WINDSHIELD - POLY

- .125" clear poly carbonate
- Mounts with four simple P-clamps

» 2883288 • **\$209⁹⁹**
150 EFI '18-22



HALF-WINDSHIELD - POLY

- 13" tall
- .125" clear poly carbonate
- Mounts with four simple P-clamps

» 2883298 • **\$134⁹⁹**
150 EFI '18-22

FOR THE LIFE OF YOUR RIDE

PARTS THAT PUSH THE LIMITS WITHOUT SACRIFICING STRENGTH AND DURABILITY.
We build our products so anyone with the right tools can maintain their vehicle.

POLARIS
ENGINEERED PARTS & LUBRICANTS

PARTS & GARAGE

MAINTENANCE

OIL & LUBRICANTS

MAINTENANCE FLUIDS

BATTERIES & GARAGE ACCESSORIES

HD PARTS

SERVICE PARTS

TIRE SEALANT & TRAILERING

POLARIS POWER

93

MAINTENANCE TIP

BREAK-IN PERIOD

The break-in period for your new RANGER is the first 25 hours of operation, or the time it takes to use the first two tanks of fuel. No single action on your part is as important as a proper break-in period. Careful treatment of a new engine will result in more efficient performance and longer life for the engine.

NOTICE: Excessive heat build-up during the first three hours of operation will damage close-fitted engine parts. Do not operate at full throttle or high speeds for extended periods during the first three hours of use.

SEE OUR LATEST MAINTENANCE TIPS AT RANGER.POLARIS.COM/EN-CA/SELF-HELP

AIR FILTER

A clogged air filter can restrict air flow to the engine leading to reduced engine performance, engine life or catastrophic failure.

BRAKE PADS

Maintaining and/or replacing brakes are critical to the safety and functionality of a vehicle. Brake pads should be checked for wear and oil or grease (petroleum products) contamination and brake discs should be checked for cracks, excessive corrosion or warping.

HALF SHAFT

Check for tears and punctures in the boot, which can lead to CV joint wear that can contribute to axle failure.

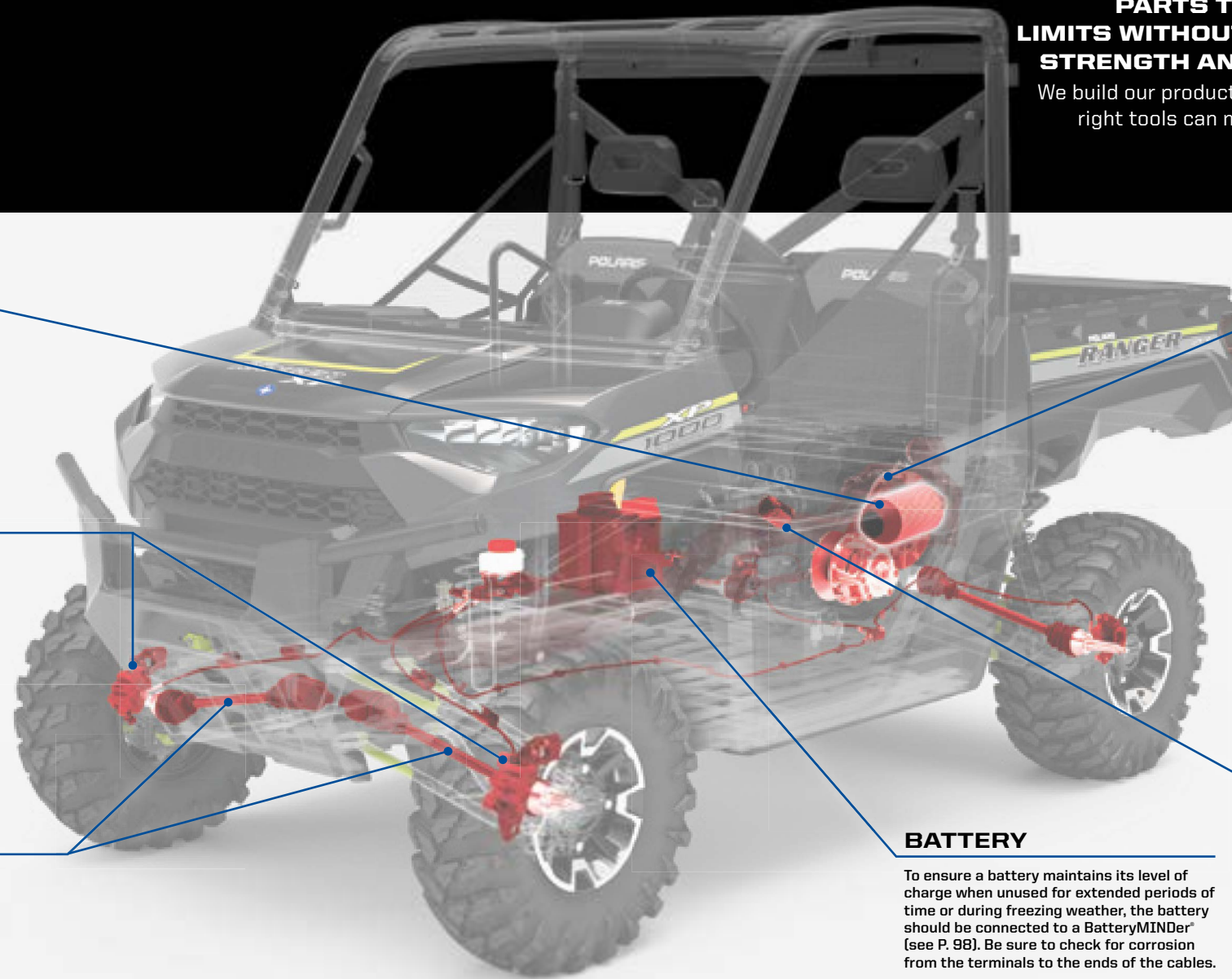

DRIVE BELT

Polaris Engineered belts deliver unmatched performance for your off-road vehicle. Developed and tested on all our engines for all environments and conditions. Check your belt for delamination, hour glassing and glazing.

BREAK-IN PERIOD

- Use lower gear (if available) while varying speeds and avoid wide open throttle for 5-10 miles / 8-16 km
- If no low gear is available, vary at moderate speeds while avoiding wide open throttle for 50 miles / 80 km

OUR INVESTMENT

- 40,000+ miles / 32,187 km of field testing
- Thousands of dyno hours
- 18+ months of development (13,000+ design hours) per belt
- 1,500+ vehicle validation hours
- Collaboration with powertrain and clutch engineers

YOUR ADVANTAGE

- No clutch recalibration
- Less wear and tear due to heat
- Ensure maximum vehicle performance
- More time riding, less time wrenching
- Produced in collaboration with powertrain and clutch engineers to ensure a perfect fit, maximum performance and ultimate durability

OIL FILTER

Change oil filters with every oil change to provide the best engine protection and keep the engine operating at peak performance.

BATTERY

To ensure a battery maintains its level of charge when unused for extended periods of time or during freezing weather, the battery should be connected to a BatteryMINDER® (see P. 98). Be sure to check for corrosion from the terminals to the ends of the cables.

FOLLOW RECOMMENDED SERVICE INTERVALS IN THE OWNER'S MANUAL

MAINTENANCE SCHEDULE

25 HRS / 250 Mi / 400 km

BREAK-IN MAINTENANCE

- ENGINE OIL & OIL FILTER:** CHANGE
- GENERAL LUBRICATION:** ALL FITTINGS, PIVOTS, CABLES, ETC.
- AIR FILTER:** INSPECT & REPLACE AS NEEDED
- EXHAUST SYSTEM:** INSPECT & CLEAN
INSPECT FOR LEAKAGE OR CARBON BUILD UP AT JOINTS
INSPECT & CLEAN SCREEN TYPE SPARK ARRESTOR

50 HRS / 500 Mi / 800 km

6 MONTHS

- EXHAUST SYSTEM:** INSPECT & CLEAN
INSPECT FOR LEAKAGE OR CARBON BUILD UP AT JOINTS
INSPECT & CLEAN SCREEN TYPE SPARK ARRESTOR
- GENERAL LUBRICATION:** ALL FITTINGS, PIVOTS, CABLES, ETC.

100 HRS / 1,000 Mi / 1,600 km

12 MONTHS

- ENGINE OIL & OIL FILTER:** CHANGE
- DRIVE BELT:** INSPECT & ADJUST
REPLACE AS NEEDED
- TRANSMISSION FLUID:** CHANGE
- FRONT DRIVE FLUID:** CHANGE
- DRIVE BELT:** INSPECT & ADJUST
REPLACE AS NEEDED
- EXHAUST SYSTEM:** INSPECT & CLEAN
INSPECT FOR LEAKAGE OR CARBON BUILD UP AT JOINTS
INSPECT & CLEAN SCREEN TYPE SPARK ARRESTOR

150 HRS / 1,500 Mi / 2,400 km

18 MONTHS

- ENGINE OIL & OIL FILTER:** CHANGE
- BATTERY:** TEST, CLEAN & REPLACE AS NEEDED
- DRIVE BELT:** INSPECT & ADJUST
REPLACE AS NEEDED
- TIRES:** INSPECT CONDITION & PRESSURE
- EXHAUST SYSTEM:** INSPECT & CLEAN
INSPECT FOR LEAKAGE OR CARBON BUILD UP AT JOINTS
INSPECT & CLEAN SCREEN TYPE SPARK ARRESTOR

200 HRS / 2,000 Mi / 3,200 km

24 MONTHS

- ENGINE OIL & OIL FILTER:** CHANGE
- BRAKE PADS & FLUID:** INSPECT & CLEAN
REPLACE AS NEEDED
- SPARK PLUGS:** INSPECT
REPLACE AS NEEDED
- EXHAUST SYSTEM:** INSPECT & CLEAN
INSPECT FOR LEAKAGE OR CARBON BUILD UP AT JOINTS
INSPECT & CLEAN SCREEN TYPE SPARK ARRESTOR

250 HRS / 2,500 Mi / 4,023 km

30 MONTHS

- ENGINE OIL & OIL FILTER:** CHANGE
- BATTERY:** TEST, CLEAN & CHECK FLUID LEVEL
REPLACE AS NEEDED
- DRIVE BELT:** INSPECT & ADJUST
REPLACE AS NEEDED
- GENERAL LUBRICATION:** ALL FITTINGS, PIVOTS, CABLES, ETC.
- EXHAUST SYSTEM:** INSPECT & CLEAN
INSPECT FOR LEAKAGE OR CARBON BUILD UP AT JOINTS
INSPECT & CLEAN SCREEN TYPE SPARK ARRESTOR

300 HRS / 3,000 Mi / 4,828 km

36 MONTHS

- ENGINE OIL & OIL FILTER:** CHANGE
- AIR FILTER:** INSPECT & REPLACE AS NEEDED
- GEARCASES:** CHECK OIL LEVEL
- EXHAUST SYSTEM:** INSPECT & CLEAN
INSPECT FOR LEAKAGE OR CARBON BUILD UP AT JOINTS
INSPECT & CLEAN SCREEN TYPE SPARK ARRESTOR

CHECK YOUR OWNER'S MANUAL FOR ADDITIONAL RECOMMENDED SERVICE ITEMS AND VEHICLE-SPECIFIC TIMING

OIL



NEW PS-4 FORMULATIONS BEST PROTECTION, BEST PERFORMANCE

Our new PS-4 5W-50 formulation and PS-4 Extreme Synthetic 0W-50 have been designed to provide the best fluid technologies for long lasting wear protection. These formulations include a new Polaris exclusive additive system to keep the engine cleaner from deposit build-up to maximize power and powersports-grade synthetic base stocks that provide the ultimate in engine protection.

PS-4 5W-50 FULL-SYNTHETIC OIL

Optimal for ambient operating temperatures of -40° F to 100° F

» 1 Quart 2876244 » 1 Gallon 2876245 » 16 Gallons 2876247 » 55 Gallon Drum 2876246 » 330 Gallon Tote 2878814

PS-4 0W-50 EXTREME FULL-SYNTHETIC OIL

Optimal for ambient operating temperatures of 0° F to 130° F

» 1 Quart 2889395 » 1 Gallon 2889396 » 16 Gallons 2889397 » 55 Gallon Drum 2889398 » 330 Gallon Tote 2889399

OIL CHANGE KITS

PS-4		These convenient kits include everything needed including filter and oil volume per vehicle	PS-4 EXTREME
PART NUMBER	VEHICLE FITMENT		PART NUMBER
2202166	RANGER/RZR/SPORTSMAN 570, TWIN 600, TWIN 700, TWIN 800		2879004
2879323	RANGER, POLARIS GENERAL 900-1000, RZR 900-1000, RS1		2879324
2877473	RANGER/SPORTSMAN 300-500, SPORTSMAN/SCRAMBLER 500/850/1000		2878924
2881696	RZR TURBO		2881697

ENGINE WEAR TEST LOWER NUMBER = LESS WEAR OF CRITICAL ENGINE PARTS LESS WEAR MEANS LONGER ENGINE LIFE

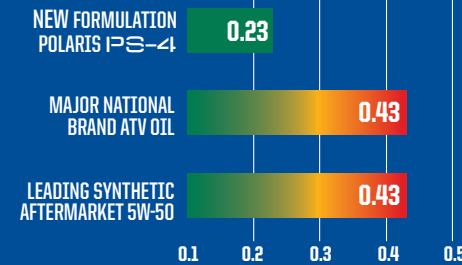

ASTM D4172. In 3rd party against 11 competitive products Polaris had 40% or better wear protection compared to all of the test products.

THE BEST PROTECTION

- At least 40% improved wear protection compared to previous Polaris PS-4 formulation and all aftermarket oils tested

Best engine protection against wear for the longest engine life.

DEPOSIT TEST LOWER DEPOSITS = MAXIMUM POWER

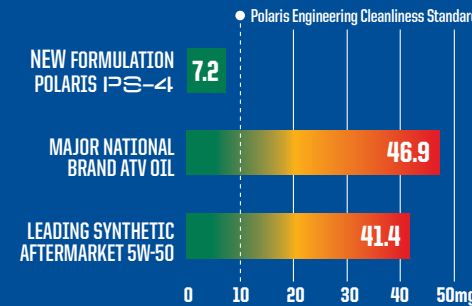

ASTM D6395. In 3rd party against 9 competitive products Polaris PS-4 had less than half the deposits compared to the next closest product. No other tested products met Polaris Engineering standards for deposit cleanliness.

MAXIMUM PERFORMANCE

- New improved PS-4 formulation provides 33% less deposits than previous PS-4 formula
- At least 50% less deposits than all aftermarket oils tested

The cleanest engine for maximum power and performance!

POLARIS EXTREME SYNTHETICS

Our new PS-4 Extreme Synthetic 0W-50 formulation applies only to the **absolute highest performance** products we sell, for ultimate protection and performance in the most extreme conditions.



- Our best extreme high temp formulation, excellent for severe high temperatures and for racing, even at temps over 54°C.

- Provides easier starting and cold temperature protection, even to extreme cold temps of below -42°C.

- Latest in premium synthetic PAO and Ester base stocks along with careful balance of moly and ZDDP additives for ultimate long lasting wear protection.

- Polaris exclusive clean engine additive system reduces deposits and carbon build-up for peak performance and power.



POLARIS INVESTS IN EACH OIL AT AND ABOVE THESE LEVELS

12+ DEDICATED
TEAM MEMBERS

FOCUSED ON
POLARIS OIL

18+
MONTHS

DEVELOPMENT
& TESTING

76,000+
HOURS

DYNO
TESTING

1.9 MILLION
MILES (3,057,753 KM)

FIELD
TESTING

MAINTENANCE FLUIDS



ENGINE OIL

Maximum protection for your 4-cycle engine.

Change every 100 hours, 6 months or 500 miles / 800 km.



AGL

Protect gears, drive chain and bearings from scoring and wear.

Change every 100 hours, 12 months or 1,000 miles / 1,600 km.

- » 1 QT • 2878068
- » 1 GALLON • 2878069
- » 2.5 GALLONS • 2878070
- » 55 GALLONS • 2879594



ORV MAINTENANCE KITS

Everything you need, in the correct fluid volumes, to maintain your drive train and keep your vehicle in top operating condition

- Includes: 1.5 quarts AGL, 1 quart Angle Drive Fluid, 1 pint Demand Drive Fluid, 1-3 OZ tube of All-Season Grease
» 2880425
ALL MODELS
- Includes: 2.5 quarts of PS-4, 2 Spark Plugs, 1 Air Filter, 2 quarts of AGL, 1 pint Demand Drive Fluid & 1 Paper Oil Funnel
» 2830555
'13-19 XP 900
- **NEW** Includes: 2 Spark Plugs, 1 Air Filter, 2 quarts PS-4, 1 Oil Filter, 1 pint Demand Drive Fluid, 2 quarts AGL, 1 Crush Washer, 1 Paper Funnel
» 2830556
'18-22 XP 1000



DOT 4 BRAKE FLUID

A high-quality brake fluid designed for use in Polaris hydraulic brakes.

Change every 200 hours, 2 years or 2,000 miles / 3,200 km.

- » 12 OZ • 2872189



ANTI-FREEZE

Prevent corrosion on metal components, eliminate scaling and maximize cooling system performance.

Change every 60 months.

- » 1 QT • 2880514
- » 1 GALLON • 2880513
- » 55 GALLONS • 2880512



DEMAND DRIVE FLUID

Provide positive 4WD engagement in extreme cold or high heat conditions and protect internal components under heavy loads.

Change every 100 hours, 12 months or 1,000 miles / 1,600 km.

- » 1 QT • 2877922
- » 2.5 GALLONS • 2877923



PREMIUM GAS SHOCK OIL

- » 1 QT • 2874124
WALKER EVANS RACING® REBUILDABLE SHOCKS
- » 1 QT PREMIUM • 2870995
- » 2.5 GALLONS PREMIUM • 2872279
FOX® REBUILDABLE SHOCKS



SUSPENSION/ U-JOINT GREASE

- » 3 OZ • 2871515
- » 14 OZ • 2871551



CHAIN LUBRICANT

- Provides superior anti-wear and shock protection
- » 16 OZ AEROSOL 2872348



ALL-SEASON GREASE TUBE

- Specialized water-resistant lubricant
- » 3 OZ • 2871322
- » 14 OZ • 2871423



ANGLE DRIVE FLUID

- Extreme pressure, anti-wear and high viscosity film lubrication for maximum protection
- » 1 QT • 2876160
- » 2.5 GALLONS • 2872276
SPORTSMAN, RANGER, RZR ANGLE DRIVE GEAR CASE SYSTEMS



GENERATOR OIL

- 4-cycle engine oil
- » 1 QT • 2879383



CARBON CLEAN

- Ultimate fuel and injection system cleaner
- » 12 OZ • 2881413



ADVANCED FUEL TREATMENT

- Dual antioxidant formula protects jets and fuel system from gum and varnish
- » 12 OZ • 2881416
- » 2.5 GALLONS • 2881417

BatteryMINDER®

ENSURE YOUR RIDE IS
READY WHEN YOU ARE.

GARAGE ACCESSORIES

- Add years of capacity, power and range to new and older batteries, regardless of type or brand
- Never over- or under-charged in any temperature
- Leave your vehicle connected for months and return to fully charged and conditioned batteries
- Recover older or weak batteries that would normally need to be replaced

- Charge and maintain extra backup batteries, as well as those in your vehicle
- Automatic turn-on, sleeps while keeping your batteries at full charge
- Easy push-button selector to change battery type or time



- NEW**
PREMIUM MAINTENANCE TOOL KIT
- Includes everything you need to work on and repair Polaris vehicles
 - Lifetime warranty on select tools
- » 2830565 • **\$659⁹⁹**



- NEW**
1,000 AMP ULTRASAFE LITHIUM JUMP PACK
- Delivers 1,000 amps for jump starting a dead battery in seconds
- » 2830547 • **\$169⁹⁹**



- NEW**
JUMP PACK PROTECTION CASE
- Lightweight, durable and rugged custom exterior
- » 2830548 • **\$26⁹⁹**



- FLEX SPOUT**
- Fits all Polaris gear, gallon and 2.5 gallon bottles
- » 2871285 • **\$3⁹⁹**



- FLUID FUNNEL**
- Easily add oil with high accuracy
- » 2830552 • **\$17⁹⁹**



- GREASE GUN**
- Enables easy application of grease
- » 2871312 • **\$44⁹⁹**
FITS 2871322 ALL-SEASON AND 2871515 U-JOINT 3 OZ



- PUMP**
- Fits 1 and 2.5 gallon bottles
- » 2870465 • **\$9⁹⁹**



- FLUID TRAY**
- Holds up to 8 quarts of fluid
- » 2830551 • **\$26⁹⁹**



- 2D BATTERY-OPERATED SIPHON PUMP**
- Liquid transfer pumps 5-6 quarts/min suctioning power
- » 2830513 • **\$20⁹⁹**



- POLARIS SHOP TOWELS**
- » 200 CT WITH DISPENSER (SHOWN) 2830402 • **\$28⁹⁹**
 - » 200 CT REFILL • 2830403 • **\$19⁹⁹**
 - » 64 CT REFILL • 2830440 • **\$6⁹⁹**



- OIL FILTER WRENCH**
- Remove Polaris ORV oil filters with ease
- » 2830550 • **\$10⁹⁹**



- FLUID SYRINGE**
- Easily add and remove fluid from your vehicle
- » 2830553 • **\$39⁹⁹**



- POLARIS HEAVY-DUTY SCRUBBER WIPES**
- » 90 CT • 2830441 • **\$24⁹⁹**

	2012 AGM 2 AMP	2012 LEAD ACID 2 AMP	1510 1.5 AMP	1.5 AMP CONVERTIBLE
PART NUMBER • PRICE	2830438 • \$121⁹⁹	2830531 • \$109⁹⁹	2830404 • \$79⁹⁹	2830511 • \$91⁴⁹
VOLTAGE • WARRANTY	12 V • 5 Years	12 V • 5 Years	12 V • 10 Years	12 V • 5 Years
CHARGING CURRENT	2 amp	2 amp	1.5 amp	1.5 amp
OVERCHARGE PROTECTION	Yes			
BATTERIES MAINTAINED	6 at one time		4 at one time	
BATTERY COMPATIBILITY	12 V Sealed AGM Lead-Acid	12 V Flooded (filler cap) and Sealed Maintenance-Free Batteries		
COMES WITH	• Non-fused battery clip cord set with Quick Connector	• BC-2410: 2' non-fused battery clip cord set with Quick Connector • RTA-2415: 2' fused ring terminal cord set with Quick Connector • ATS-1: Ambient temperature sensor	• Ambient temperature sensor (installed) • 12' power cord • Battery clip cord set with Quick Connector • Optional permanent mounting tab	• Auto-temp compensation sensor (installed) • Optional permanent mounting brackets and screws • Battery clips (fully-insulated, aircraft grade, 15A replaceable fuse) • Ring terminal assembly with 15A replaceable fuse
KEY FEATURES	Designed for high-performance specialty AGM sealed batteries	Diagnoses battery condition - can predict failing batteries	Easy to use, economical	Convertible on-vehicle or bench top use

BATTERY MAINTENANCE TIPS

Extend your battery life with a BatteryMINDER® and these tips:

1. Store batteries in a cool, dry location.
2. Check that the battery connections are tight. Cables should not be able to be rotated or shifted by hand.
3. If your battery has a drain tube, make sure it is free of clogs.
4. Clean your battery - use a soft brush to scrub the top of the battery. Use baking soda to remove grease.
5. Connect a BatteryMINDER® after using your vehicle even if the vehicle is in regular use.

BatteryMINDER® ACCESSORIES



- BatteryMINDER® 12' CABLE**
- Made with heavy-duty, 16-gauge black zip cord featuring automotive SAE bullet connectors
- » 2830410 • **\$15⁹⁹**



- BatteryMINDER® VPP-12:12/24 VOLT VEHICLE POWER PLUG**
- Allows easy connection to vehicle battery through lighter or 12/24 V power port with replaceable 15 amp fuse
- » 2830518 • **\$16⁹⁹**



- BatteryMINDER® SPLITTER**
- Connect two batteries simultaneously for easy battery maintenance
 - Cap includes a set of ring terminals
- » 2830409 • **\$45⁹⁹**



- BatteryMINDER® RING TERMINAL**
- Features 24" long 18-gauge wire
 - Plug has standard 5/16" negative and 3/8" positive terminals
 - Replaceable 15 amp in-line fuse for circuit protection
- » 2830437 • **\$12⁹⁹**



- BatteryMINDER® EZ CONNECT**
- Allows for quick, easy connecting and disconnecting of your BatteryMINDER®
 - Includes a set of ring terminals
- » 2830411 • **\$32⁹⁹**



- POLARIS X3 CREEPER**
- Three positions: Flat, 45-degree angle or seated work stool
 - Helps you perform any repair with ease
 - Stay dry and warm away from cold, wet cement floors
 - Easily stores away when not in use
- » BLACK • 2830429 • **\$179⁹⁹**



- POLARIS MAGNETIC PARTS TRAY**
- » SILVER • 2830432 • **\$15⁹⁹**



- POLARIS 33" TELESCOPIC MAGNET**
- » BLACK • 2830435 • **\$6⁹⁹**



- POLARIS 12" HI-TORQUE RATCHETING DRIVER**
- » BLACK / BLUE • 2830434 • **\$24⁹⁹**



- POLARIS LED POCKET FLASHLIGHT**
- » BLACK • 2830436 • **\$30⁹⁹**

HD HEAVY DUTY PARTS

All Polaris parts are developed and tested to help you get the most out of your ride. We're taking the passion of our riders, workers and outdoor enthusiasts to the next level with HD Parts.

Engineered and designed for:

- Greater durability
- Enhanced performance
- Greater wear and tear capabilities
- All weather conditions

NEW OIL FILTERS

The advanced synthetic material built into these filters offers the highest debris holding capacity, maintains oil flow and maximizes performance.

OE	HD HEAVY DUTY PARTS
2540086	2522498



WHEEL BEARINGS

Fully sealed for added protection against intrusions. Made of a higher grade steel for extended life in extreme conditions.

LOCATION	OE	HD HEAVY DUTY PARTS
FRONT WHEEL BEARINGS	3514924	3515090
	3514634	3515088
REAR WHEEL BEARINGS	3514924	3515090
	3514917	3515087
	3514635	3515087



WHEELS & TIRES

Class leading durability for off-road performance and traction for confident driving in extreme conditions.

- » 1524022-458 • HD WHEEL - 14x7*
- » 5417507 • PRO ARMOR HD-K - 29x10R14*
- » 5457498-458 • HD WHEEL CENTER CAP*
- » 5415756 • PRO ARMOR XD-K FRONT
- » 5415757 • PRO ARMOR XD-K REAR

* SHOWN



NEW DRIVE BELTS

The enhanced rubber material compound in these belts keep them cool in extreme heat, while our patented cord treatment process maximizes the transfer of horsepower to the ground for those customers hauling heavy loads.

OE	HD HEAVY DUTY PARTS
3211149	
3211169	3212326
3211196	
3211113	3212328



BUSHINGS

The advanced material compound of the bushings enables tighter tolerances to reduce overall wear on the system, while the superior triple lip sealing prevents intrusion of the elements.



LOCATION	OE	HD HEAVY DUTY PARTS
FRONT UPPER BUSHINGS	5439874	1543367
	5439730	1543326
FRONT LOWER BUSHINGS	5439874	1543367
	5439730	1543326
REAR UPPER BUSHINGS	5439874	1543367
	5439730	1543326
REAR LOWER BUSHINGS	5439874	1543367
	5439730	1543326
UPPER HUB BUSHINGS	5439270	1543326
LOWER HUB BUSHINGS	5439270	1543326

NEW BRAKES

Engineered to provide longer life and better stopping power while riding in extreme conditions.

OE	HD HEAVY DUTY PARTS
2205949	2208933
2202413	2208934
2203318	2208936



BUSHING KITS

Easily update the entire front and rear suspension.

- » 2830560
XP 900 '13-'19, XP 900 CREW '14-'19, XP 1000 '17, XP 1000 CREW '17, 570 FULL SIZE '15-'20, 570 FULL SIZE CREW '15-'20
- » 2830561 (SHOWN)
570 EFI '14-'20, 570 EFI CREW '14-'20

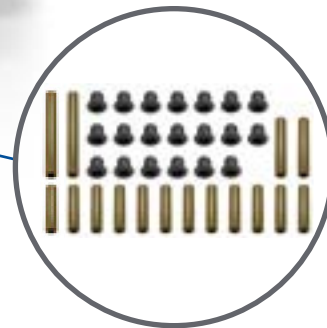

Claims made based off testing and performance of Polaris HD Parts against standard OEM parts made by Polaris and competitor brands under normal use.

For more information regarding Polaris HD parts including vehicle compatibility, installation and maintenance, please contact your authorized Polaris ORV dealer.

VISIT [POLARIS.COM/HDPARTS](https://www.polaris.com/hdparts) TO LEARN MORE

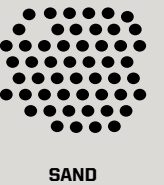

SAND



MUD



WATER



EXTREME COLD



EXTREME HEAT UP TO 130° F



HEAVY PAYLOADS



EXTENDED LIFE

PARTS & GARAGE

MAINTENANCE

OIL & LUBRICANTS

MAINTENANCE FLUIDS

BATTERIES & GARAGE ACCESSORIES

HD PARTS

SERVICE PARTS

TIRE SEALANT & TRAILERING

POLARIS POWER

SERVICE PARTS

Polaris Engineered service parts deliver unmatched performance and fit for your off-road vehicle.

All service parts are engineered specifically for your machine. Which means everything is designed, tested and perfected to maximize the life of your ride. Getting Polaris Engineered parts is a decision that pays off in the long run, because it ensures there is a long run.



SHOP FOR SERVICE PARTS ONLINE OR VISIT YOUR POLARIS DEALER.

OVER
100,000
PARTS
AVAILABLE!



CHECK OUT OUR PARTS FINDER ON POLARIS.COM

FOR EASY PARTS LOOK-UP, PARTS IDENTIFICATION, VIEWS OF ASSEMBLIES & MORE!



STEP 1

Visit **Polaris.com/RANGER**
Click the **"Accessories & Parts"** tab
Click **"Parts & Maintenance"**



STEP 2

Enter **vehicle year/model** or
shop by **part number**



STEP 3

Clearly see what parts are
required and **order**

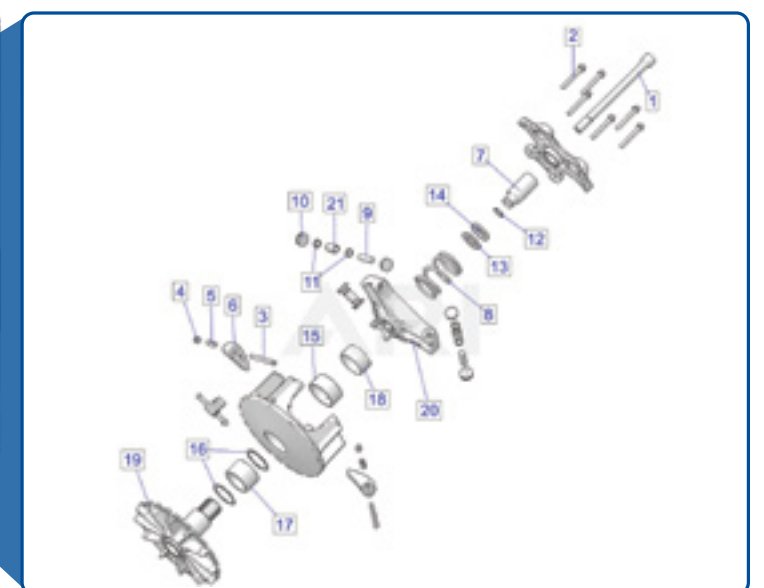

CV BOOT REPAIR KIT*

- A quick trail-side fix to increase trail time
- The flexible and durable boot material expands "over a cone tool for CV boot repairs, without disassembling CV axles
- Universal fit - works as a temporary fix for most powersports axles
- All components fit inside the cone, and a cover is provided for compact durable storage
- Easily fits in a cargo box, attached to the roll cage, in the glovebox or many other storage locations



Items shown are contained inside cone

FIX ON THE GO | TEMPORARY COVERAGE

UTV CV BOOT REPAIR KIT

- Kit includes the following items:
- (1) Expandable XL CV Boot
 - (1) Reusable Cone Tool
 - (2) CV Boot Clamps
 - (1) Tube of Silicone Lube
 - (1) Grease Packet
 - (1) Cone Cover

» 2830526 • \$36⁹⁹

UTV TRAIL BOOT ONLY

- » 2830527 • \$18⁹⁹
- ### ATV
- CV REPAIR KIT 2830528 • \$31⁹⁹
 - TRAIL BOOT ONLY 2830529 • \$18⁹⁹

SEE HOW THE CV BOOT REPAIR KIT WORKS AT POLARIS.COM/MAINTENANCE-VIDEOS

HOW TO INSTALL

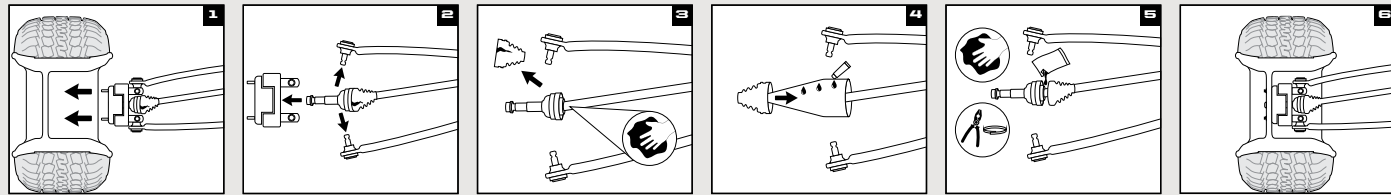

- Remove wheel and axle nut.
- Remove brake caliper, hub, tie rod and upper and lower ball joints.
- Remove old boot and clean joint.
- Spread silicone lube on entire cone tool. Slide boot over cone tool, large end first. See package for outer boot instructions.
- Empty the bag of grease into the CV joint/boot, clean sealing points and install clamps.
- Reassemble tie rod, ball joints, brake caliper, axle nut, tire and wheel.

Refer to your service manual for further instructions and torque specifications. *Designed for temporary CV boot repair. Purchase the OEM CV Boot for a permanent repair.

TIRE SEALANT

HOW IT WORKS

Tire sealant remains liquefied inside the tire until a leak develops in the tire or wheel.



Once a leak occurs, the tire sealant rushes out of the tire and quickly creates a permanent solid plug.

The plug maintains the pressure of the tire so you can continue your ride.



PREMIUM TIRE SEALANT

- Instantly seals and repairs rim, bead leaks and punctures up to .25" on standard tires and .75" on heavy ply tires
- Helps maintain air pressure for the life of the tire
- Helps seal the tire bead against the wheel
- 100% water soluble for easy cleanup
- Will not rust, corrode or pit wheels
- Creates permanent repair
- Remains fluid and effective in temperatures down to -45° F
- Easily installed through existing tire valve stem with valve core removed

- » 32 OZ • 2830484 • \$25⁹⁹
- » 1 GALLON • 2830485 • \$89⁹⁹
- » 5 GALLONS • 2830486 • \$364⁹⁹
- » 5 GALLONS, PUMP • 2830487 • \$163⁹⁹
- » 55 GALLONS • 2830489
- » 275 GALLONS • 2830488

HOW MUCH TIRE SEALANT DO YOU NEED?

$$\frac{\text{TIRE HEIGHT (IN.)} \times \text{TIRE WIDTH (IN.)}}{5} = \text{OUNCES REQUIRED PER TIRE}$$

$$\frac{27" \times 10"}{5} = 54 \text{ oz}$$

FOR A FULL APPLICATION CHART, VISIT POLARIS.COM/TIRESEALANTCHART

BRING IT EVERYWHERE

TRAILERING



CALIBER® RAMP PRO

- Designed for ATVs and UTVs up to 50" wide
 - Integrated grip glides for ultimate traction
 - Folding sides for easy transportation and storing
- » 52" x 90" • 2884576 • \$519⁹⁹



ALUMINUM ARCHED LOADING RAMPS

- Capacity for up to 3,000 lbs
- » 76" x 12" • 2,000 lb • 2875384 • \$279⁹⁹
- » 88" x 12" • 3,000 lb • 2875386 • \$459⁹⁹



LIGHTWEIGHT TRI-FOLD RAMPS

- Ramp folds up for transport
- Capacity for up to 1,500 lbs
- Safety straps included
- » 72" x 51" • 2875385 • \$309⁹⁹
- » 82" x 51" • 2875860 • \$369⁹⁹

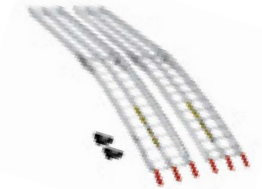

FOLDING ALUMINUM ARCHED RAMPS

- Ramp folds up for transport
- Up to 1,500 lbs total capacity, per individual ramp
- Safety straps included
- » 88" x 12" • 2875387 • \$379⁹⁹

HITCHES

3:1 HITCHES VERSATILE 3 IN 1 FUNCTIONALITY

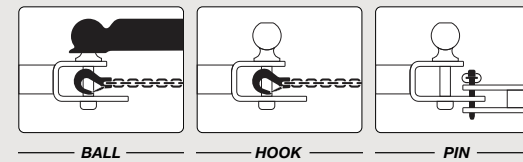

- Ball, hook and pin design
- Durable, rust resistant steel with black powdercoated finish
- Removable ball
- HD 5/8" pin and clip



HITCH WITH 2" BALL

- » 2" x 2" RECEIVER 2830522 • \$48⁹⁹
- » 1 1/4" x 1 1/4" RECEIVER 2830523 • \$48⁹⁹



1 7/8" BALL

- 1 7/8" replacement ball for hitch
- Designed to work with 3:1 Hitch
- » 2830524 • \$12⁹⁹



2" HITCH BALL MOUNT

- » 2" RECEIVER TONGUE 2875320 • \$59⁹⁹



TRAILER BALL 3/4" SHANK

- » 2" BALL • 2877603 • \$18⁹⁹
- » 1 7/8" BALL • 2877602 • \$18⁹⁹



RECOVERY STRAP

- 2" x 30'
- 18,000 lb maximum load / 9,000 lb maximum vehicle weight
- Built in strap wrap - easy storage
- Loops sewn in to webbing
- 1 Strap bag
- » 2884033 • \$74⁹⁹



RATCHET STRAP

- 1.5" x 15' straps, 2 Pack
- Heavy duty webbing
- 5,500 lb maximum load / 1,833 lb working load
- 2 Pack
- » 2884031 • \$59⁹⁹



RATCHET STRAP

- 2" x 20' Ratchet Straps with heavy duty webbing
- 10,000 lb Maximum Load / 3,300 lb Working Load
- Floating D-Rings
- Double J-Hooks
- » 2884032 • \$43⁹⁹



SHOCK STRAPS

- 1.5" 3,000 lb breaking strength
- Keeps tension on tie-down straps to secure load
- 2 Pack
- » 2883296 • 1.5" x 15' • \$109⁹⁹
- » 2883295 • 1.5" x 7' • \$94⁹⁹

COVERS

2-SEAT & CREW TRAILERING COVERS

- » 2880632 • 570/500/EV • \$434⁹⁹
- EV '15-21, 570 '15-22, 500 '17-22
- » 2880633 • 570 CREW • \$564⁹⁹
- CREW 570-4 '15-22



3-SEAT & CREW TRAILERING COVERS

- » 2883419 • XP 1000 • \$434⁹⁹
- XP 1000 '15-22, 1000 '20-22
- » 2883840 • CREW XP 1000/900/DIESEL • \$564⁹⁹
- XP 1000 '18-22, CREW XP 1000 '17-22, CREW 1000 '20-22
- » 2882160 • POLARIS PURSUIT CAMO SxS FIELD COVER • \$169⁹⁹
- XP 1000 '14-22, EV '11-22, 570 FULL-SIZE '17-22, 570 '14-22, 500 '11-22, 1000 '20-22

PARTS & GARAGE

MAINTENANCE

OIL & LUBRICANTS

MAINTENANCE FLUIDS

BATTERIES & GARAGE ACCESSORIES

HD PARTS

SERVICE PARTS

TIRE SEALANT & TRAILERING

POLARIS POWER

POLARIS POWER

FOR THE WORKERS, PLAYERS
AND SAVE-THE-DAYERS.



THE POWER TO EMPOWER

At Polaris Power, we are committed to powering more.
We proudly donate 3% of our profits by providing
portable power to areas affected by natural disasters
and the organizations providing relief in North America.

PARTS & GARAGE

MAINTENANCE

OIL & LUBRICANTS

MAINTENANCE
FLUIDS

BATTERIES & GARAGE
ACCESSORIES

HD PARTS

SERVICE PARTS

TIRE SEALANT
& TRAILERING

POLARIS POWER



P2000i

Inverter Generator

2830532

\$899 99

1600 Running Watts	2000 Starting Watts	16.7 Max Amps at 120V	7.6 Run Time at 25% Load w/ Smart Throttle (hrs)	62 Noise Level at 25% Load (dBA)
------------------------------	-------------------------------	---------------------------------	--	--

FEATURES



Extension Cord Management



Multi Functional Digital Display



Illuminated Control Panel



Multi Handle Design



Parallel Capable

BEST USED FOR



Tailgating



Off-Grid



Camping



ACCESSORIES 2830536 INVERTER PARALLEL KIT
2830540 ALL WEATHER COVER

2884865 HIGH ALTITUDE MODIFICATION KIT
2879383 GENERATOR OIL

P3200iE

Inverter Generator

2830533

\$1,899 99

2800 Running Watts	3200 Starting Watts	23.3 Max Amps at 120V	10.1 Run Time at 25% Load w/ Smart Throttle (hrs)	67 Noise Level at 25% Load (dBA)
------------------------------	-------------------------------	---------------------------------	---	--

FEATURES



Key Fob Remote Start



Multi Functional Digital Display



Fuel Gauge



Extension Cord Management



Parallel Capable

BEST USED FOR



DIY Remodeling



One Room Backup



Camping



ACCESSORIES 2830536 INVERTER PARALLEL KIT
2830541 ALL WEATHER COVER

2884866 HIGH ALTITUDE MODIFICATION KIT
2879383 GENERATOR OIL

READ, UNDERSTAND AND FOLLOW YOUR OWNER'S MANUAL. Never operate a generator indoors. Generator exhaust contains carbon monoxide vapors and exposure can result in severe injury or death. Gasoline is highly flammable and explosive under certain conditions. Always use extreme care whenever handling gasoline.



P5500

Open Frame Generator

2830534

\$1,799 99

5000
Running
Watts

5500
Starting
Watts

20/30
Max Amps
at 120/240V

5
Run Time
(hrs)

75
Noise Level
(dBA)

FEATURES



Extension Cord Management



Fuel Gauge



Electric Start



Rough Terrain Wheel

BEST USED FOR



Construction



Home Backup



RV'ing



ACCESSORIES

2830542
2884867

ALL WEATHER COVER
HIGH ALTITUDE MODIFICATION KIT

2879383 GENERATOR OIL

P6500

Open Frame Generator

2830535

\$1,999 99

6000
Running
Watts

6500
Starting
Watts

20/30
Max Amps
at 120/240V

5
Run Time
(hrs)

75
Noise Level
(dBA)

FEATURES



Extension Cord Management



Fuel Gauge



Electric Start



Rough Terrain Wheel

BEST USED FOR



Construction



Home Backup



RV'ing



ACCESSORIES

2830542
2884867

ALL WEATHER COVER
HIGH ALTITUDE MODIFICATION KIT

2879383 GENERATOR OIL



NEW
OFF-ROAD RIDING JERSEYS

\$43⁹⁹

Mesh ventilated panels for maximum airflow
Elastic sleeves with non-restrictive cuffs

NEW
OFF-ROAD RIDING GLOVES

\$30⁹⁹

Adjustable wrist closure for a custom fit
Silicon finger grips and neoprene knuckle protection



TEKVEST® FREESTYLE

\$433⁹⁹

Black | S-3XL | 2862577



BLACK
JERSEY | S-3XL | 2862718
GLOVE | S-3XL | 2862726

ORANGE
JERSEY | S-3XL | 2862719
GLOVE | S-3XL | 2862729

TEAL
JERSEY | S-3XL | 2862720
GLOVE | S-3XL | 2862727

GREEN
JERSEY | S-3XL | 2862721
GLOVE | S-3XL | 2862730

BLUE
JERSEY | S-3XL | 2862722
GLOVE | S-3XL | 2862728

YOUTH JERSEY
\$37⁹⁹
S-XL | 2862723

YOUTH JERSEY
\$37⁹⁹
S-XL | 2862724

YOUTH JERSEY
\$37⁹⁹
S-XL | 2862725



SHORT SLEEVE

\$45⁹⁹

Men's | S-3XL | 2860634
Women's | S-3XL | 2860636



LONG SLEEVE

\$58⁹⁹

Men's | S-3XL | 2860638
Women's | S-3XL | 2860640



RAIN JACKET

\$129⁹⁹

Gray | S-3XL | 2869527



RAIN PANTS

\$109⁹⁹

Gray | S-3XL | 2869528

COOLING SHIRTS

FABRIC TECHNOLOGY DESIGNED
TO KEEP YOU COOL

- Chemical-free fabric, Coolcore® reduces the surface temperature up to 30% so you don't overheat
- Carries a 50 Ultraviolet Protection Factor rating, blocking 98% of harmful UV rays



RAIN JACKET & PANTS

PACKABLE WATERPROOF PROTECTION AGAINST
UNPREDICTABLE WEATHER

- 100% waterproof, lightweight and packable nylon
- YKK® zippers
- Rain jacket has removable hood

HELMETS

FOR
POLARIS

NEW
TAN
XS-4XL
2862472



ALTITUDE

509 ALTITUDE 2.0 HELMET

LIGHTWEIGHT DESIGN, PERFORMANCE-INFUSED
STYLE AND FEATURES WITH ALL-DAY COMFORT

SHELL **\$371⁹⁵**

- Strong, lightweight construction of carbon fiber or fiberglass

WEIGHT

- Composite as low as 1,260g
- Carbon fiber as low as 1,150g

FEATURES

- Superior fit for all-day comfort
- Removable Pro Series breath box provides excellent ventilation and air flow
- One-piece eyepoint creates draft-free seal with 509 goggles
- Magnetic Fidlock® chin-strap technology and integrated GoPro® mount
- DOT- and ECE 22.05-approved

FIDLOCK



BLACK
XS-4XL
2861469

BLACK/RED
XS-4XL
2861472

RED/BLACK
XS-4XL
2861470

\$495⁹⁵

**CARBON FIBER
BLACK/LIME**
XS-4XL | 2861473

FOR
POLARIS

RED/BLACK
XS-4XL
2862467



TACTICAL

NEW TACTICAL 2.0 HELMET

BUILT FROM THE GROUND UP WITH INNOVATIVE
FEATURES FOR ULTIMATE COMFORT AND CONTROL

SHELL **\$272⁹⁵**

- Shock-resistant, injection-molded thermoplastic

FEATURES

- Venturi vent system generates negative pressure at velocity and pulls moist air from the breath box
- Integrated eyepoint seal is co-integrated with the breath box and creates a draft-free seal with 509 goggles for unparalleled warmth and clear field of view
- Magnetic Fidlock® chin-strap technology
- DOT- and ECE 22.06-approved

FIDLOCK



MATTE BLACK
XS-4XL
2862468

GRAY
XS-4XL
2862469

LIME
XS-4XL
2862470

ORANGE
XS-4XL
2862471

GOGGLES



ORANGE
2862561



LIME
2862559

NEW 509 KINGPIN OFF-ROAD GOGGLE

PREMIUM MATERIALS, ATTRACTIVE PRICE **\$61⁹⁵**

FEATURES

- Oversized spherical lens delivers optimal peripheral vision
- Metal tear-off posts provide strength and durability
- Quick-change technology allows you to run the best lens tint for conditions



BLUE
2862562



STEALTH
2862560

NEW 509 MX6 OFF-ROAD GOGGLE

SUPER WIDE FIELD OF VIEW, ENGINEERED FOR DIRT **\$123⁹⁵**

FEATURES

- PC outer lens with anti-scratch coating, and internal anti-fog coating
- Outriggers with latch system for quick lens change
- 45mm strap with silicone to hold strap in place



BLACK
2862557



RED/BLACK
2862558

MEN'S APPAREL

BLACK
S-3XL | 2862569



NAVY
S-3XL | 2862570



NEW WORK VEST

RUGGED AND DURABLE VEST THAT'S IDEAL AS AN OUTDOOR LAYER

- Coated with Durable Water Repellency (DWR) to provide water-resistance
- 3M™ Thinsulate® for added warmth with brushed flannel trim
- Three outer pockets for storage

\$123⁹⁹



CHARCOAL
S-3XL | 2860865



BRONZE
S-3XL | 2860864

FLANNEL JACKET

SHERPA FLEECE LINED JACKET DELIVERS EXCEPTIONAL WARMTH AND COMFORT

- Warm sherpa lined fleece material
- Insulation to keep you warm
- Plenty of storage for your valuables

\$123⁹⁹



FOREST GREEN
S-3XL | 2860862



GRAY
S-3XL | 2860863



BLACK
S-3XL | 2861608

WORK JACKET

WARM AND RUGGED JACKET THAT'S TOUGH FOR WORK AND STYLISH FOR PLAY

- Coated with Durable Water Repellency (DWR) to provide water-resistance
- Built in action back for increased range of motion
- 80g 3M™ Thinsulate® for added warmth with brushed flannel trim
- One inner and four outer pockets for storage

\$198⁹⁹

NEW
RED
S-3XL | 2862451



BLACK
S-3XL | 2861434



GRAY
S-3XL | 2861435

SOFTSHELL JACKET

VERSATILE LIGHTWEIGHT JACKET THAT'S SURPRISINGLY WARM AND PERFECT FOR EVERYDAY WEAR

- Casual jacket armed with rugged and warm features for everyday wear
- Superior DWR prevents precipitation from saturating the jacket's exterior
- Lined with 280g of soft fleece for warmth
- Removable hood and underarm venting, three external pockets and one internal chest pocket

\$161⁹⁹

NEW REVOLVE VEST

REVERSIBLE

DURABLE AND WARM REVERSIBLE VEST OFFERS TWO STYLES IN ONE

- Durable windbreak outer fabric helps protect from the elements
- 140g 3M™ Thinsulate® insulation keeps you warm in cold weather
- Reversible vest offers two unique styles in one

\$123⁹⁹



BLUE/ORANGE
S-3XL | 2862566

NEW WINDBREAKER JACKET

LIGHTWEIGHT, WINDPROOF JACKET THAT PROVIDES PROTECTION WHILE RIDING

- 100% polyester windproof fabric
- Lightweight construction makes it easy to pack
- Three external pockets allow for maximum storage

\$132⁹⁹

Black | S-3XL | 2861541



FORCE JACKET

PACKABLE JACKET OFFERS LIGHTWEIGHT PROTECTION, IDEAL FOR ANY ACTIVITY

- 140g 3M™ Thinsulate®
- Plenty of storage with two external hand pockets and one internal media pocket
- Rugged YKK® zippers
- Great for travel, compacts into pocket

\$173⁹⁹

Black | S-3XL | 2861432



BLACK/GRAY
S-3XL | 2862565



APPAREL

RIDING GEAR

HELMETS & GOGGLES

MEN'S APPAREL

WOMEN'S APPAREL

MERCHANDISE

NEW
TITAN MID-LAYER

EXTREMELY WARM YET BREATHABLE MID-LAYER, PERFECT FOR RIDING

- 319g Polartec® Thermal Pro® rib sweater provides great warmth
- Quick drying moisture wicking helps keep you dry
- Breathable material moves sweat to the outer surface
- Nylon overlay is comfortable and light

\$111.99

BLACK
S-3XL | 2862568

BLUE/ORANGE
S-3XL | 2862567



NEW
TAN
S-3XL | 2862450

RED/BLACK
S-3XL | 2862490



NORTHSTAR MID-LAYER

VERSATILE MID-LAYER CAN BE WORN ALONE OR AS AN EXTRA LAYER

- 280g of breathable fleece for added warmth
- Offers durable protection against the elements with a wear-resistant polyester face and wind-block layer on chest
- Designed to fit under outer shell when riding

\$111.99

BLACK/RED
S-3XL | 2862616

BLACK/GRAY
S-3XL | 2869925

NEW
JOURNEY HOODIE

DURABLE HOODIE DESIGNED FOR EVERY DAY WEAR

- Keeps the elements out with snug, rib-knit waist and cuffs
- Mock neck collar provides added protection and warmth
- Durable blended material made of 80% cotton, 20% polyester

\$86.99

BLACK
S-3XL | 2862489



TECH FULL-ZIP HOODIE

\$80.99

- **NEW** Tan | S-3XL | 2862486
- Gray | S-3XL | 2861493
- Black/Blue | S-3XL | 2861494



CREW SWEATSHIRT

\$61.99

- **NEW** Black | S-3XL | 2862488
- Green | S-3XL | 2861498
- Navy | S-3XL | 2861497



ICON HOODIE

\$68.99

- **NEW** Gray | S-3XL | 2862487
- Green | S-3XL | 2861495
- Black | S-3XL | 2861496



ICON LONG SLEEVE

\$37.99

- **NEW** Gray/Red | S-3XL | 2862505
- Black | S-3XL | 2861584
- Blue | S-3XL | 2861585



DASH LONG SLEEVE

\$37.99

- **NEW** Gray | S-3XL | 2862504
- Navy | S-3XL | 2861583
- Black | S-3XL | 2861582



CHECKERED LONG SLEEVE

\$37.99

- **NEW** Red | S-3XL | 2862506
- Gray | S-3XL | 2861587
- Black | S-3XL | 2861586



ICON TEE

\$30.99

- **NEW** Green | S-3XL | 2862501
- Black | S-3XL | 2861570
- Blue | S-3XL | 2861571



STAMP TEE

\$30.99

- **NEW** Black | S-3XL | 2862496
- Gray | S-3XL | 2861565
- Green | S-3XL | 2861564



CORE TEE

\$30.99

- **NEW** Red | S-3XL | 2862502
- Black | S-3XL | 2861572
- Blue | S-3XL | 2861573

MEN'S CAMO

STEALTH CAMO HAT

\$32⁹⁹

Camo | One Size | 2861527

NORTHSTAR MID LAYER

\$119⁹⁹

Camo | S-3XL | 2861542

CAMO SOFTSHELL JACKET

\$172⁹⁹

Camo | S-3XL | 2861543



NEW

CAMO REVOLVE VEST

\$123⁹⁹

Camo | S-3XL | 2862572



NEW

PURSUIT HOODIE

\$61⁹⁹

Camo | S-3XL | 2862494



CAMO NECK GAITER

\$16⁹⁹

Camo | One Size | 2861948



CAMO TRUCKER HAT

\$32⁹⁹

Black | One Size | 2860613



HUNTER ORANGE HAT

\$30⁹⁹

Orange | S/M | 2860892
Orange | L/XL | 2862545



HUNTER ORANGE BEANIE

\$24⁹⁹

Orange | One Size | 2862595

MEN'S BALL CAPS



ELLIPSE PATCH TRUCKER HAT

\$32⁹⁹

NEW Light Gray | One Size | 2862539
Gray | One Size | 2861531
Black | One Size | 2861533
Navy | One Size | 2861532

NEW

HIGHLAND CAP

\$30⁹⁹

Tan | One Size | 2860893
Gray | One Size | 2862544



CORE CAP

\$32⁹⁹

NEW Gray | One Size | 2862594
Navy | One Size | 2861523
Black | One Size | 2861524



TONAL HAT

\$32⁹⁹

Black/Red | One Size | 2861526
Navy | One Size | 2861525



NEW

CLASSIC CAP

\$30⁹⁹

Gray | One Size | 2862543
Navy | One Size | 2862597



CHECKERED HAT

\$32⁹⁹

Blue | One Size | 2861520
Black | One Size | 2861522
Gray | One Size | 2861521



RETRO CAP

\$30⁹⁹

NEW Navy | One Size | 2862538
Gray/Red | One Size | 2869542
Gray/Orange | One Size | 2861536

APPAREL

RIDING GEAR

HELMETS & GOGGLES

MEN'S APPAREL

WOMEN'S APPAREL

MERCHANDISE

NEW
BLUE
S-3XL | 2862460



BLACK
S-3XL | 2862563



BLACK
S-3XL | 2861437

GRAY/BLUE
S-3XL | 2861439

BLUE
S-3XL | 2862564

SOFTSHELL JACKET

LIGHTWEIGHT PERFORMANCE THAT'S SURPRISINGLY WARM AND PERFECT FOR EVERYDAY WEAR

- Superior DWR prevents precipitation from saturating the jacket's exterior
- Lined with 280g of soft fleece for warmth
- Removable hood and underarm venting, three external pockets and one internal chest pocket

\$161⁹⁹



BLACK
S-3XL | 2862457

DUSTY ROSE
S-3XL | 2862456

BLACK
S-3XL | 2861433

REVOLVE VEST

DURABLE AND WARM REVERSIBLE VEST OFFERS TWO STYLES IN ONE

- Durable windbreak outer fabric protects you from the elements
- 140g 3M Thinsulate® insulation keeps you warm in cold weather
- Reversible vest offers two unique styles in one

\$123⁹⁹

FORCE JACKET

PACKABLE JACKET OFFERS LIGHTWEIGHT PROTECTION, IDEAL FOR ANY ACTIVITY

- 140g 3M Thinsulate®
- Plenty of storage with two external hand pockets and one internal media pocket
- Rugged YKK® zippers
- Great for travel, compacts into pocket

\$173⁹⁹

TITAN MID-LAYER

EXTREMELY WARM YET BREATHABLE MID-LAYER, PERFECT FOR RIDING

- 319g Polartec® Thermal Pro® rib sweater provides great warmth
- Quick drying moisture wicking helps keep you dry
- Breathable material moves sweat to the outer surface
- Nylon overlay is comfortable and light

\$111⁹⁹



BLACK/GRAY
S-3XL | 2862458

DUSTY ROSE
S-3XL | 2862459

NEW WORK JACKET

WARM AND RUGGED JACKET THAT'S TOUGH FOR WORK AND STYLISH FOR PLAY

- Coated with DWR to provide water-resistance
- Built-in action back for increased range of motion
- 80g 3M Thinsulate® for added warmth with brushed flannel trim
- One inner and four outer pockets for storage

\$198⁹⁹



NEW
PURSUIT HOODIE
~~\$61⁹⁹~~
Camo | S-3XL | 2862517



NEW JOURNEY HOODIE

\$86⁹⁹
Black | S-3XL | 2862515
Blue | S-3XL | 2862516

TECH FULL-ZIP HOODIE

\$80⁹⁹
Maroon | S-3XL | 2861509
Gray | S-3XL | 2861508

ICON HOODIE

\$68⁹⁹
NEW White | S-3XL | 2862512
Black | S-3XL | 2861506
Maroon | S-3XL | 2861507



NEW ADVENTURE CREW

\$61⁹⁹
Dusty Rose | S-3XL | 2862513
Black | S-3XL | 2862514

NEW ADVENTURE TEE

\$30⁹⁹
Teal | S-3XL | 2862629
Black Frost | S-3XL | 2862628

THINK OUTSIDE TEE

\$30⁹⁹
NEW Pink | S-3XL | 2862518
Black | S-3XL | 2861590
Blue | S-3XL | 2861591

MERCHANDISE



STEEL SIGN
14" x 36" | 2860868
\$168⁹⁹



ALUMINUM SIGN
22" | 2860867
\$168⁹⁹



WOOD SIGN
10.5" x 24" | 2860866
\$97⁹⁹



PINT GLASSES (SET OF 2)
2860815 | \$25⁹⁹



12oz CAMPER MUG
2861612 | \$39⁹⁹



17oz WATER BOTTLE
2861611 | \$32⁹⁹



NEW
23oz WATER BOTTLE
2862685 | \$30⁹⁹



15oz CAMPFIRE MUG
2861613 | \$26⁹⁹



KEYCHAIN
2861614 | \$8⁹⁹



LEATHER LOOP KEYCHAIN
2861615 | \$19⁹⁹



NEW
LICENSE PLATE HOLDER
2862687 | \$24⁹⁹



NEW
KICKBACK ROCKER
2862626 | \$68⁰⁰



NEW
FREESTYLE ROCKER
2862625 | \$81⁰⁰



NEW
EASY CHAIR
2862627 | \$56⁰⁰



NEW
QUICK-E-SEAT
2862624 | \$43⁰⁰



NEW
FOLDING TABLE
2861620 | \$66⁹⁹



NEW
POLARIS PARKING SIGN
2869934 | \$24⁹⁹



NEW
POLARIS FLAG
3' x 5' | 2869928 | \$30⁹⁹



NEW
HITCH COVER
2861623 | \$43⁹⁹



APPAREL

RIDING GEAR

HELMETS & GOGGLES

MENS APPAREL

WOMENS APPAREL

MERCHANDISE

HARDEST WORKING.

SMOOTHEST RIDING.

GET THE BEST OWNER EXPERIENCE OUT THERE

Our goal is to make every day of ownership a smooth ride. Sign in for access to everything you need, plus exclusive offers and more.

OFFROAD.POLARIS.COM/ACCOUNT



MY GARAGE

- Vehicle Profile & Accessory Details
- Maintenance Schedules
- Schedule Service
- Manuals & Warranty Info



MY RIDES & COMMUNITY

- My Tracked Rides
- My Planned Routes & POIs
- My Community Activities & Events
- Explore Polaris Adventures



MY SHOPPING

- Recommended Accessories
- Purchase History
- My Dealer
- Access to Polaris Pros



CONNECT ONLINE
SEARCH "PolarisDRV"



DOMINATE

ANY ENVIRONMENT

1 CHOOSE MODEL

2 CHOOSE TRIM

3 CHOOSE COLOR

4 CHOOSE ACCESSORIES

VISIT POLARIS.COM/RANGER
TO SEE VEHICLE OPTIONS AND VIEW ACCESSORIES
ON YOUR NEW MACHINE FROM EVERY ANGLE!



Warning: Polaris off-road vehicles can be hazardous to operate and are not intended for on-road use. Driver must be at least 16 years old with a valid driver's license to operate. All riders should always wear helmets, eye protection and protective clothing and footwear. Read, understand and follow your owner's manual. Ride within the limits of your own abilities and never engage in stunt or exhibition driving. Never ride under the influence of drugs or alcohol. All riders should take a safety training course. Call 800-342-3764 for additional information.

POLARIS

MY22 RGR APP ACC CAN 9948143

Unless noted, trademarks are the property of Polaris Industries Inc. 3M® and Thinsulate® are registered trademarks of 3M Company, 509® is a registered trademark of Teton Outfitters, LLC. Apple® and App Store® are registered trademarks of Apple Inc. Batteryminder® is a registered trademark of VDC Electronics Inc. Bluetooth® is a registered trademark of Bluetooth Sig, Inc. Caliber® is a trademark of Caliber, Inc. Carhartt® is a registered trademark of Carhartt, Inc. COOLCORE® is a registered trademark of COOLCORE LLC. Facebook® is a registered trademark of Facebook, Inc. Fidlock® is a registered trademark of Fidlock GmbH. Google Play® is a registered trademark of Google, Inc. GoPro® is a registered trademark of GoPro Inc. Homelink® is a registered trademark of Gentex Corporation. Instagram® is a registered trademark of Instagram, LLC. KOLPIN® and KOLPIN STRONGHOLD® are registered trademarks of Polaris Industries Inc. MB Quart® is a registered trademark of Maxxsonics USA Inc. Otter® is a registered trademark of Otter Outdoors, LLC. Polartec® is a registered trademark of MMI-IPCO, LLC. Rhino Grip® is a registered trademark of Polaris Industries Inc. RHINO-RACK® is a registered trademark of Rhino Rack Australia Pty Limited. RIGID® is a trademark of JST Performance, LLC d/b/a Rigid Industries LLC. SMART BOARD® is a registered trademark of MART TECHNOLOGIES ULC UNLIMITED LIABILITY CORPORATION CANADA. Tiger Drylac® is a registered trademark of Tiger Coatings GMBH & CO. KG. TEKVEST® is a registered trademark of 1181676 ONTARIO INC. Twitter® is a registered trademark of Twitter, Inc. WALKER EVANS RACING® is a registered trademark of Walker Evans Enterprises Incorporated. Yeti® is a registered trademark of Yeti Coolers, LLC. YKK® is a registered trademark of YKK Corporation. YouTube® is a registered trademark of Google Inc. Prices, Fitment and Availability are subject to change at any moment. Copyright © 2021 Polaris Industries Inc. All rights reserved.