

# POLARIS XPEDITION



2024

**ACCESSORIES,  
GARAGE & APPAREL**

ENGLISH VERSION



## KEEP CHASING THE WILD

Inspiration was invented outdoors. Those four missed calls and 13 unread messages can wait until Monday. Gather your crew and all your gear to reach deep into the backcountry. Polaris XPEDITION will get you there in a comfortable, capable off-road vehicle that adapts to your lifestyle. Endless adventure awaits.

## INTRODUCING



The next generation of Lock & Ride technology lets you customize your vehicle with easy-to-install storage solutions to pack everything you need for your adventure. Plus, the new storage system lets you quickly adapt your vehicle with limitless storage configurations to best meet your riding needs no matter what adventure lies ahead.

## 2024 LINEUP

SEE THE FULL LINEUP AT [POLARIS.COM/PolarisXPEDITION](https://PolarisXPEDITION.COM)

### POLARIS XPEDITION XP

#### PREMIUM

AVAILABLE STARTING IN 2024



#### ULTIMATE



#### NORTHSTAR



### POLARIS XPEDITION ADV

#### PREMIUM

AVAILABLE STARTING IN 2024



#### ULTIMATE



#### NORTHSTAR



### 08 NORTHSTAR

### 10 ACCESSORIES

- 20 WINDSHIELDS & REAR PANELS
- 22 DOORS
- 24 CAB COMFORT
- 26 VEHICLE PROTECTION
- 28 STORAGE
- 34 OVERLANDING/CAMPING
- 35 RECOVERY
- 36 AUDIO
- 38 CONNECTED TECHNOLOGY
- 40 HUNT
- 42 POLARIS NORTHSTAR COOLERS
- 44 LIGHTING
- 48 WHEELS & TIRES
- 56 WINCHES, PLOWS & TRACKS

### 58 PARTS & GARAGE

- 58 MAINTENANCE
- 60 OIL & LUBRICANTS
- 62 MAINTENANCE FLUIDS
- 64 GARAGE ACCESSORIES
- 65 BATTERY CHARGERS, HD PARTS & SERVICE PARTS
- 66 TIRE SEALANT & TRAILERING
- 68 POLARIS POWER

### 74 APPAREL

- 75 POLARIS XPEDITION APPAREL
- 76 JERSEYS & GLOVES
- 77 HEATED APPAREL
- 78 HELMETS & GOGGLES
- 80 MEN'S APPAREL
- 84 BALL CAPS & BEANIES
- 86 WOMEN'S APPAREL
- 88 HOME & COLLECTIBLES

**BUILD YOUR OWN**  
AT [POLARIS.COM/PolarisXPEDITION](https://PolarisXPEDITION.COM)



**DESIGNED** by the people who designed your vehicle.



**TESTED** extensively in the field so you ride with 100% confidence.



**TRUSTED** 65+ years in the business. The #1 name in off-road.

ACCESSORIES  
BACKED BY A



WARRANTY



From opposite sides of the globe, some of the most capable machines in the off-road world meet a trusted outdoor adventure brand to deliver industry-exclusive Rhino-Rack® bed racks and accessories designed specifically for Polaris XPEDITION. Perfectly integrated and tested to off-road standards, Rhino-Rack® storage solutions will help you get more storage capacity out of your Polaris XPEDITION, so you can stay prepared for whatever the day may bring.

WE HOLD OUR  
PARTNERS TO THE  
SAME STANDARDS



WHEELS, TIRES & LIGHTING DESIGNED WITH  
POLARIS TO MAXIMIZE PERFORMANCE  
P. 47 & 48



PRODUCTS SO GOOD THEY REPLACE  
OR REPAIR THEM FOR LIFE  
P. 46



DARE TO LISTEN WITH  
HIGH-PERFORMANCE AUDIO  
P. 36



MAKING PRODUCTS FOR AVID  
SPORTSMEN SINCE 1943  
P. 40



DIGITAL GAUGES FOR  
POWERSPORTS RIDERS  
P. 39



BRING IT ALL.  
BRING IT ON.  
P. 32



# ENGINEERED FOR MORE



## ULTIMATE ADVENTURE READINESS

Unlock experiences beyond the trailhead with Polaris XPEDITION. Developed and tested alongside the vehicle, Polaris Engineered accessories are designed for seamless integration and simple installation so you can take your adventure further.

### GO FURTHER



## PLUG & PLAY ELECTRICAL

A revolution in electrical accessory integration, the Polaris PULSE Electrical System allows for a simple plug & play approach for adding power to Polaris Engineered accessories.

P. 25

PRO PRO HEAVY DUTY SERIES

## WINCHES

### INTEGRATED, PRE-WIRED WINCH MOUNT

Designated mounting points and pre-wired contactors ensure a perfect fit in the strongest location for attaching a Polaris Engineered winch. With wiring built right into the vehicle, we made winch installation simple.

P. 56

### EXPLORE ALL YEAR-ROUND



## MAXIMIZED RIDER COMFORT

Add a new level of interior comfort with a Pro Shield Cab System, which has been tested to military standards. Seal out dust, water and noise with a windshield, rear panel and full doors.

P. 20

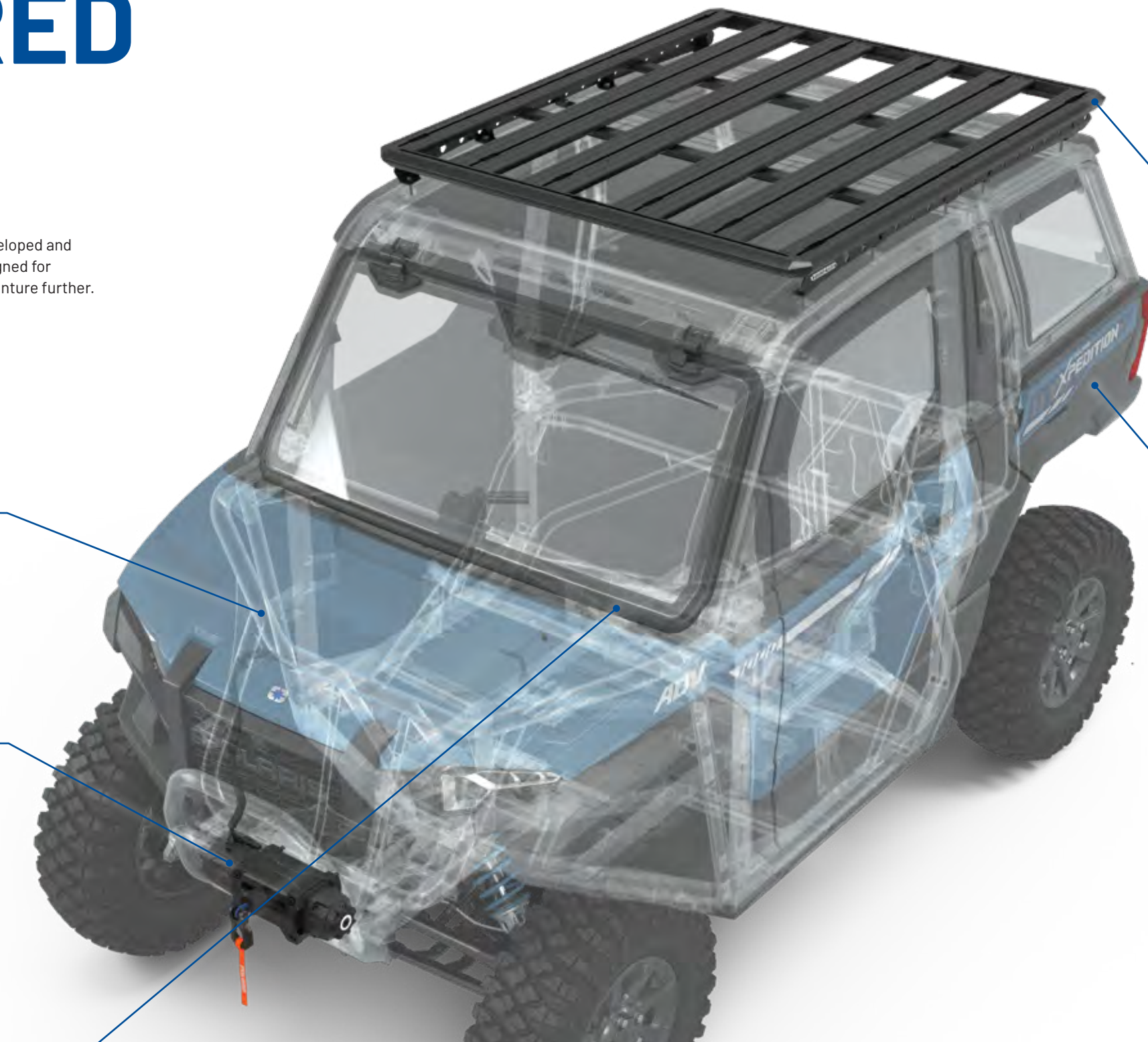

### MAXIMIZE OUTDOOR EXPERIENCES



## BRING IT ALL. BRING IT ON.

Rhino-Rack® roof rack and bed rack solutions offer 40% more storage capacity so you never have to leave tools or gear behind.

P. 32



## ADAPTABLE STORAGE SOLUTIONS

The next generation of the Polaris Lock & Ride platform brings with it an entirely new system of purpose-built accessories and attachments. This means you can go further, push harder and do more than ever before.

P. 29



## EASY ON & OFF

Adapt to your needs and environment with exclusive toolless, easy on/off Lock & Ride components.

P. 20

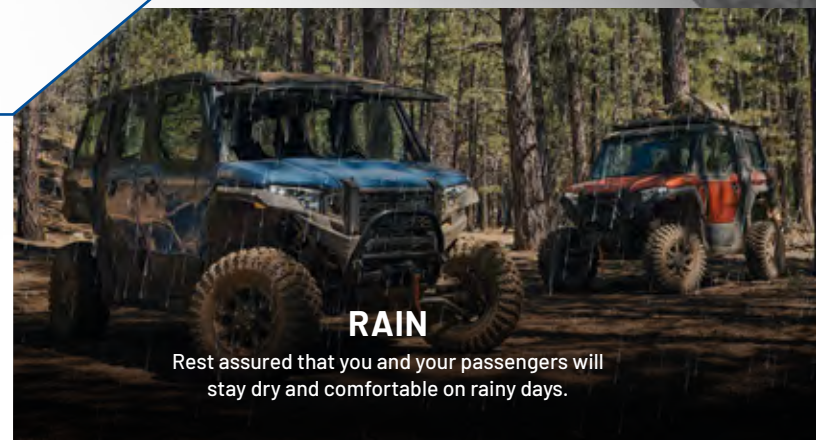

### RAIN

Rest assured that you and your passengers will stay dry and comfortable on rainy days.



### SNOW

Keep cold wind and snow out during the winter months.



### DUST

Reduce dust swirl in the cab of your vehicle for increased comfort and visibility.



# YEAR-ROUND COMFORT

# POLARIS XPEDITION NORTHSTAR

Be in control of your comfort with a standard Pro Shield cab system, heat, air conditioning and more. A NorthStar trim helps you finish whatever task you set out to do, no matter the weather conditions.



## ACCESSORIZE IT

### PROTECTION

Protect the front and rear of your vehicle from whatever obstacles you may encounter while off-roading.

P. 26

### STORAGE

Leave nothing behind with the limitless customization of Lock & Ride MAX and Rhino-Rack® storage solutions.

P. 28

### LIGHTING

Extend the day with premium, easy-to-install lighting from RIGID® and Pro Armor.

P. 44

### WHEELS & TIRES

Choose from multiple terrain-specific tires, then add style with five lug wheel options.

P. 48

## UPGRADE YOUR NORTHSTAR

CUSTOMIZE FOR YOUR RIDING STYLE

You've got the essentials straight from the factory, but why stop there? Get the most out of your NorthStar with additional Polaris Engineered accessories built to fit your riding needs.



**POLARIS XPEDITION XP NORTHSTAR**  
(2-SEAT / 5-SEAT)



**POLARIS XPEDITION ADV NORTHSTAR**  
(2-SEAT / 5-SEAT)

### BOTH COME STANDARD WITH:

Heating & Air Conditioning System  
JBL® Audio System  
Full Glass Tip Out Windshield with Wiper/Washer System  
Full Poly Doors with Power Windows

Glass Rear Panel (XP only) / Glass Rear Liftgate (ADV only)  
Rear Glass Side Panels (ADV only)  
Polaris HD 4,500 LB Winch  
Sport Roof with Premium Liner & Dome Light

LED Headlights  
Pro Armor 30" Crawler XP Tires  
Locking Doors  
Weatherproof Convex Rearview Mirror

	PRODUCT	PART NUMBER (2-SEAT / 5-SEAT)	PAGE
MUST HAVES	Adjustable Folding Side Mirrors	2884491	P. 24
	HD Extreme Kick-Out Rock Sliders	2884495-458 / 2884497-458	P. 26
	Rear Bumper	2884498-458	P. 26
	RIGID® SR-Series 32" Combo LED Light Bar	2884299	P. 47
ADVENTURE	Hood Rack	2889387	P. 30
	Rhino-Rack® Roof Rack	2889590 / 2889237	P. 32

**SHOP FOR YOUR RIDING NEEDS WITH OUR ACCESSORY COLLECTIONS**  
SEE FOLLOWING PAGES





# OVERLAND COLLECTION

For the ultimate adventurers wishing to get out into nature or camp out of their vehicle. Featuring a Rhino-Rack® roof rack, rooftop tent, recovery gear, vehicle protection and premium lighting.

- 2884485 Glass Windshield Wiper Kit, Rear: P. 21
- 2884491 Adjustable Folding Side Mirrors: P. 24
- 2890545 RAM® Phone Mount: P. 24
- 2884497-458 HD Extreme Kick-Out Rock Sliders, 5-Seat: P. 26
- 2884494-458 HD Front Bumper: P. 26
- 2889331-458 HD Rear Bumper: P. 26
- 2884503 Hood Rack - HD Bumper: P. 30
- 2889468-458 **LR RIGID MAX** Cross Bed Bar: P. 30

- 2889336-458 **LR RIGID MAX** Spare Tire Carrier: P. 30
- 2889623 **LR RIGID MAX** Rear Floor Rail Kit: P. 31
- 2890894 **LR RIGID MAX** D-Rings: P. 31
- 2889478 Rear Window Molle Panels: P. 31
- 2889237 Rhino-Rack® Roof Rack, Large: P. 32
- 2889452 Rhino-Rack® Roof Rack Mount, Large: P. 32
- 2890560 Rooftop Tent: P. 34
- 2890646 **LR RIGID MAX** MAXTRAX® Traction Boards & Mounts: P. 35

- 2890542 Recovery Shackles: P. 35
- 2883968 Polaris NorthStar 15 QT Cooler: P. 43
- 2883126 RIGID® D-Series Pro Flood LED Lights: P. 46
- 2889731 RIGID® SR-M-Series Pro Driving LED Lights: P. 46
- 2889567 RIGID® RDS SR-Series 50" Curved Single-Row Light Bar: P. 47
- 2889591 50" Light Bar Harness: P. 47
- 2889820 Front HD Bumper Cube Light Mounts: P. 47

- 2889885 Front HD Bumper Cube Light Harness + Switch: P. 47
- 2884783 RIGID® Scene Lights: P. 47
- 5416397 Pro Armor Spare Tire: Crawler XG, 30": P. 50
- 1525420 Pro Armor Spare Wheel: 5304 Beadlock, 15": P. 54
- 2889995 Pro Armor Wheel & Tire Set: 5304 Beadlock & Crawler XG, 30": P. 55
- 2884839 Polaris Pro HD High-Mounted 6,000 LB Winch: P. 56

Shown on ADV NorthStar 5-Seat. Applicable to all models with adjustments.



# KAYAK COLLECTION

For the kayakers, canoers, paddle boarders or other watersport enthusiasts. Featuring a Rhino-Rack® roof rack, kayak and fishing rod holders, a half windshield, skeleton half doors and a NorthStar cooler.



- 2884411 **LR RIDE** Half Windshield - Hard Coat Poly: P. 21
- 2884717 Skeleton Half Doors, Front: P. 23
- 2884399 Skeleton Half Doors, Rear: P. 23
- 2884486 Weatherproof Convex Rearview Mirror: P. 24
- 2884491 Adjustable Folding Side Mirrors: P. 24

- 2889357-458 Low Profile Rock Sliders, 5-Seat: P. 26
- 2889478 Rear Window Molle Panels: P. 31
- 2889622 **LR RIDE MAX** Bed Rail Kit: P. 31
- 2890894 **LR RIDE MAX** D-Rings: P. 31
- 2889237 Rhino-Rack® Roof Rack, Large: P. 32

- 2889452 Rhino-Rack® Roof Rack Mount, Large: P. 32
- 2889883 Rhino-Rack® J-Style Kayak Holder: P. 33
- 2889884 Rhino-Rack® Accessory Bars: P. 33
- 2889729 Rhino-Rack® Fishing Rod Holder: P. 33
- 2883424 Polaris NorthStar 30 QT Cooler: P. 42

- 2884299 RIGID® SR-Series 32" Combo LED Light Bar: P. 47
- 2889643 Front Roof Light Bar Mounts: P. 47
- 2889892 Front Roof Light Bar Harness: P. 47
- 2889935 Pro Armor Wheel & Tire Set: 5302 Beadlock & Crawler XG, 30": P. 55

Shown on ADV Ultimate 5-Seat. Applicable to all models with adjustments. Activity items shown are not sold by Polaris.





# TRAIL COLLECTION

For the casual riders looking to explore the trails through various landscapes. Featuring premium RIGID® lighting, a spare tire carrier, vehicle protection, Rhino-Rack® accessories and Pro Armor Attack 2.0 tires.

- 2889331-458 HD Rear Bumper: P. 26
- 2884495-458 HD Extreme Kick-Out Rock Sliders, 2-Seat: P. 26
- 2884714 Front A-Arm Guards: P. 27
- 2884715 Rear A-Arm Guards: P. 27
- 2889336-458 **LR LOCK RIGID MAX** Spare Tire Carrier: P. 30
- 2889622 **LR LOCK RIGID MAX** Bed Rail Kit: P. 31

- 2890894 **LR LOCK RIGID MAX** D-Rings: P. 31
- 2889237 Rhino-Rack® Roof Rack, Large: P. 32
- 2889451 Rhino-Rack® Roof Rack Mount, Large: P. 32
- 2889881 Rhino-Rack® 200 L Luggage Bag: P. 33
- 2889533 Rhino-Rack® High-Lifting Jack Mount: P. 33
- 2889508 36" High-Lifting Jack: P. 35

- 2890646 **LR LOCK RIGID MAX** MAXTRAX® Traction Boards & Mounts: P. 35
- 2890542 Recovery Shackles: P. 35
- 2889731 RIGID® SR-M-Series Pro Driving LED Lights: P. 46
- 2884299 RIGID® SR-Series 32" Combo LED Light Bar: P. 47
- 2889643 Front Roof Light Bar Mounts: P. 47
- 2889892 Front Roof Light Bar Harness: P. 47

- 5416345 Pro Armor Spare Tire: Attack 2.0, 30": P. 52
- 1525420 Pro Armor Spare Wheel: 5304 Beadlock, 15": P. 54
- 2889994 Pro Armor Wheel & Tire Set: 5304 Beadlock & Attack 2.0, 30": P. 55

Shown on ADV NorthStar 2-Seat. Applicable to all models with adjustments.



# HUNT COLLECTION

For the big gamers and the small gamers, both searching for their next trophy. Featuring Rhino-Rack® roof and bed racks, a Kolpin gun boot, premium lighting, a NorthStar cooler and a hood rack.



- 2884498-458 Rear Bumper: P. 26
- 2884496-458 Low Profile Rock Sliders, 2-Seat: P. 26
- 2889387 Hood Rack - Stock Bumper: P. 30
- 2889590 Rhino-Rack® Roof Rack, Small: P. 32
- 2889450 Rhino-Rack® Roof Rack Mount, Small: P. 32
- 2889590 Rhino-Rack® Rear Bed Rack: P. 32

- 2889453 Rhino-Rack® Rear Bed Rack Mount: P. 32
- 2889529 Rhino-Rack® Spare Tire Holder: P. 33
- 2889327 Rhino-Rack® Gun Mounting Bracket (2): P. 33
- 2889533 Rhino-Rack® High-Lifting Jack Mount: P. 33
- 2889527 Rhino-Rack® Eyelet Tie-Downs: P. 33
- 2889531 Rhino-Rack® Corner Cargo Brackets: P. 33

- 2889508 36" High-Lifting Jack: P. 35
- 2882036 Kolpin Stronghold Gun Boot XL (2): P. 40
- 2636942 Auto-Latch Mount (2): P. 40
- 2883425 Polaris NorthStar 60 QT Cooler: P. 42
- 2883424 Polaris NorthStar 30 QT Cooler: P. 42
- 2884299 RIGID® SR-Series 32" Combo LED Light Bar: P. 47

- 2889643 Front Roof Light Bar Mounts: P. 47
- 2889892 Front Roof Light Bar Harness: P. 47
- 5416345 Pro Armor Spare Tire: Attack 2.0, 30": P. 52
- 1524038 Pro Armor Spare Wheel: 5302 Beadlock, 15": P. 54
- 2889934 Pro Armor Wheel & Tire Set: 5302 Beadlock & Attack 2.0, 30": P. 55

Shown on XP NorthStar 2-Seat. Applicable to all models with adjustments.





# UTILITY COLLECTION

For the DIYers and landowners needing to get the job done, while still having fun. Featuring Lock & Ride MAX storage accessories, a hood rack, a heater & defrost kit, upper doors and a poly rear panel.

- 2884409 **LR LOCK & RIDE** Full Vented Windshield - Hard Coat Poly: P. 20
- 2889344 Rear Panel - Poly: P. 21
- 2884398 Canvas Upper Doors, Front: P. 23
- 2884486 Weatherproof Convex Rearview Mirror: P. 24
- 2884491 Adjustable Folding Side Mirrors: P. 24
- 2889734 Heater & Defrost Kit: P. 25
- 2884496-458 Low Profile Rock Sliders, 2-Seat: P. 26
- 2889387 Hood Rack - Stock Bumper: P. 30

- 2889409-458 Headache Rack: P. 30
- 2884712 **LR LOCK & RIDE MAX** Rear Storage Box: P. 30
- 2890091-458 **LR LOCK & RIDE MAX** Bed Extender: P. 30
- 2889468-458 **LR LOCK & RIDE MAX** Cross Bed Bar: P. 30
- 2890894 **LR LOCK & RIDE MAX** D-Rings: P. 31
- 2889590 Rhino-Rack® Roof Rack, Small: P. 32
- 2889450 Rhino-Rack® Roof Rack Mount, Small: P. 32
- 2889528 Rhino-Rack® Multi-Purpose Tool Holder(2): P. 33

- 2889527 Rhino-Rack® Eyelet Tie-Downs: P. 33
- 2884107 **LR LOCK & RIDE MAX** Kolpin Rhino Grip Pro: P. 41
- 2884299 RIGID® SR-Series 32" Combo LED Light Bar: P. 47
- 2884783 RIGID® Scene Lights: P. 47
- 2889643 Front Roof Light Bar Mounts: P. 47
- 2889892 Front Roof Light Bar Harness: P. 47
- 2889996 Pro Armor Wheel & Tire Set: 5304 Beadlock & Harvester, 30": P. 55

## BE PREPARED FOR SNOW

- 2889578 Glacier Plow Mount: P. 57
- 2889579 Glacier Pro HD Push Frame: P. 57
- 2889029 Glacier Pro HD Plow Hydraulic Angle System: P. 57
- 2889721 Glacier Pro HD Plow Control Handle: P. 57
- 2879317 Glacier Pro HD Plow Blade - 72" Poly: P. 57
- 2889328 Glacier 6" Blade Extensions: P. 57
- 2890649 Glacier Plow Markers: P. 57

Shown on XP Ultimate 2-Seat. Applicable to all models with adjustments. Activity items shown are not sold by Polaris.



# WINDSHIELDS

Keep the elements out and control air flow into the cab.



**LOCK & RIDE**  
REVOLUTIONARY  
INSTALLATION



**AIRTIGHT  
GASKET SEAL**

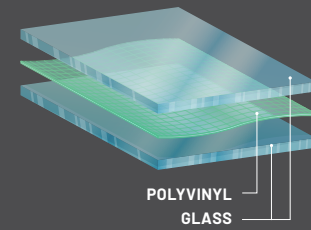

## GLASS vs POLY

Superior optical clarity  
(automotive level)  
Scratch-resistant  
Curved to fit, seals tight  
Cold weather / heavy duty  
Wiper-ready

Lightweight, flexible,  
easy to store/remove  
Impact-resistant  
Tight seal keeps out rain and dust  
Hard Coat: 30x more scratch  
resistance than regular poly

## POLARIS ENGINEERED ADVANTAGES

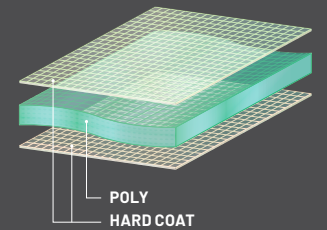

### GLASS



**PRO SHIELD  
CAB SYSTEM**  
**TIP OUT WINDSHIELD - GLASS**  
» 2884408  
POLARIS XPEDITION XP/5 '24  
POLARIS XPEDITION ADV/5 '24

**PRO SHIELD  
CAB SYSTEM**  
**FULL WINDSHIELD - GLASS**  
» 2884410  
POLARIS XPEDITION XP/5 '24  
POLARIS XPEDITION ADV/5 '24

### HARD COAT POLY



**PRO SHIELD  
CAB SYSTEM** **LOCK & RIDE**  
**FULL VENTED WINDSHIELD  
- HARD COAT POLY**  
» 2884409  
POLARIS XPEDITION XP/5 '24  
POLARIS XPEDITION ADV/5 '24

**PRO SHIELD  
CAB SYSTEM** **LOCK & RIDE**  
**FULL WINDSHIELD  
- HARD COAT POLY**  
» 2884407  
POLARIS XPEDITION XP/5 '24  
POLARIS XPEDITION ADV/5 '24



**PRO SHIELD  
CAB SYSTEM** **LOCK & RIDE**  
**HALF WINDSHIELD  
- HARD COAT POLY**  
» 2884411  
POLARIS XPEDITION XP/5 '24  
POLARIS XPEDITION ADV/5 '24

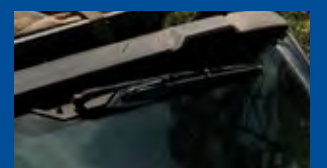

**GLASS WINDSHIELD  
WIPER KIT**  
» FRONT\* • 2884484  
POLARIS XPEDITION XP/5 '24  
POLARIS XPEDITION ADV/5 '24  
ROPS Extension Harness (2885170) required,  
sold separately  
» REAR • 2884485  
POLARIS XPEDITION ADV/5 '24  
Does not include washer system

# REAR PANELS

Turbulent air forms above the cargo bed and behind the cab when a windshield is added, which can carry dirt, dust, leaves and water into the cab. Control this swirl by adding a rear panel.



**PRO SHIELD  
CAB SYSTEM**  
**REAR PANEL - GLASS**  
» 2884412  
POLARIS XPEDITION XP/5 '24



**PRO SHIELD  
CAB SYSTEM**  
**REAR LIFTGATE - GLASS**  
• Two gas struts allow glass to remain in  
open position for easy gear loading  
» 2884413  
POLARIS XPEDITION ADV/5 '24



**PRO SHIELD  
CAB SYSTEM**  
**REAR SIDE PANELS - GLASS**  
» 2889819  
POLARIS XPEDITION ADV/5 '24



**PRO SHIELD  
CAB SYSTEM**  
**REAR PANEL - POLY**  
» 2889344  
POLARIS XPEDITION XP/5 '24

\*Check with your local dealer for availability.



# DOORS

COMPLETE YOUR CAB. Polaris XPEDITION comes equipped with half doors. To create an enclosed cab for increased protection from the elements, choose from these great Polaris Engineered options.

POLARIS ENGINEERED ADVANTAGES



PREMIUM INTERIOR HANDLE AND LINER



A PERFECT FIT FOR THE PERFECT SEAL



Interior



Interior



## FULL POLY DOORS - MANUAL WINDOWS

- A tight 360° gasket seal to the vehicle ensures the doors are fully closed
- Includes a built-in storage compartment with wipe clean inner liner
- Door-mounted crank controls
- Accent panel not included, use with panel from the factory vehicle door

»FRONT • 2884394

POLARIS XPEDITION XP/5 '24  
POLARIS XPEDITION ADV/5 '24

»REAR • 2884395

POLARIS XPEDITION XP/5 '24  
POLARIS XPEDITION ADV/5 '24

## FULL POLY DOORS - POWER WINDOWS

- A tight 360° gasket seal to the vehicle ensures the doors are fully closed
- Includes a built-in storage compartment with wipe clean inner liner
- Console-mounted window controls
- Accent panel not included, use with panel from the factory vehicle door

»FRONT • 2884396

POLARIS XPEDITION XP/5 '24  
POLARIS XPEDITION ADV/5 '24

»REAR • 2884397

POLARIS XPEDITION XP/5 '24  
POLARIS XPEDITION ADV/5 '24

## CANVAS UPPER DOORS

- Lightweight, UV-resistant canvas that is stitched over the frame
- Easily mount by attaching directly to the lower stock doors (drill hole plugs included)
- Practical zipper windows with a Velcro® holder increase venting options, without losing visibility

»FRONT • 2884398

POLARIS XPEDITION XP/5 '24  
POLARIS XPEDITION ADV/5 '24

»REAR • 2884406

POLARIS XPEDITION XP/5 '24  
POLARIS XPEDITION ADV/5 '24

## SKELETON HALF DOORS

- Round, steel tube frame with formed outer panel
- Provides an open air feel and distinct look, while offering light protection to the cab of the vehicle

»FRONT • 2884717  
POLARIS XPEDITION XP/5 '24  
POLARIS XPEDITION ADV/5 '24

»REAR • 2884399  
POLARIS XPEDITION XP/5 '24  
POLARIS XPEDITION ADV/5 '24

## UNIVERSAL VEHICLE LOCKS

- Includes seven lock tumblers and one set of keys
- Simplify vehicle locks when building a cab with one universal key

»2889848

POLARIS XPEDITION XP/5 '24  
POLARIS XPEDITION ADV/5 '24

ACCESSORIES

WINDSHIELDS, REAR PANELS & DOORS

CAB COMFORT

VEHICLE PROTECTION

STORAGE

OVERLANDING/ CAMPING & RECOVERY

AUDIO & CONNECTED TECHNOLOGY

HUNT/COOLERS

LIGHTING

WHEELS & TIRES

WINCHES, PLOWES & TRACKS



# CAB COMFORT



ACCESSORIES

WINDSHIELDS, REAR PANELS & DOORS

CAB COMFORT

VEHICLE PROTECTION

STORAGE

OVERLANDING/ CAMPING & RECOVERY

AUDIO & CONNECTED TECHNOLOGY

HUNT/COOLERS

LIGHTING

WHEELS & TIRES

WINCHES, PLOWES & TRACKS



SEE P. 20 FOR WINDSHIELDS

## GLASS WINDSHIELD WIPER KIT

- » FRONT\* • 2884484  
POLARIS XPEDITION XP/5 '24  
POLARIS XPEDITION ADV/5 '24  
ROPS Extension Harness (2885170) required, sold separately
- » REAR • 2884485  
POLARIS XPEDITION ADV/5 '24  
Does not include washer system



## WEATHERPROOF CONVEX REARVIEW MIRROR

- Built to perform off-road with a durable construction and scratch-resistant lens
  - Installs easily with multiple pre-designated vehicle frame mounting location options
  - Convex design provides a broad, expanded view of what's behind or alongside the vehicle
- » 2884486  
POLARIS XPEDITION XP/5 '24  
POLARIS XPEDITION ADV/5 '24



## RAM® PHONE MOUNT

- Easily mounts to the dash and holds a cell phone up to 3.25" wide
- » 2890545  
POLARIS XPEDITION XP/5 '24  
POLARIS XPEDITION ADV/5 '24



## ADJUSTABLE FOLDING SIDE MIRRORS

- Fully adjustable for riders of all sizes and can fold in to prevent being struck
  - Mounts on any vehicle, with or without doors
- » 2884491  
POLARIS XPEDITION XP/5 '24  
POLARIS XPEDITION ADV/5 '24



## HEATER & DEFROST KIT

- Two defrost vents to keep your windows clear and four to keep passengers comfortable
  - Adjustable temperature control and three fan speeds
- » 2889734  
POLARIS XPEDITION XP/5 '24  
POLARIS XPEDITION ADV/5 '24



## HORN KIT

- Adds a warning horn to the vehicle console
- » 2884488  
POLARIS XPEDITION XP/5 '24  
POLARIS XPEDITION ADV/5 '24



## LED DOME LIGHT

- Provides optimal visibility in the vehicle cab
- |  |   |   |
|--|---|---|
| » FRONT<br>2884487<br>POLARIS XPEDITION XP '24<br>POLARIS XPEDITION ADV '24<br>STANDARD ON NORTHSTAR TRIMS | » FRONT & REAR<br>2885169<br>POLARIS XPEDITION XP 5 '24<br>POLARIS XPEDITION ADV 5 '24<br>(Front & Cargo)<br>Replaces front dome light & harness on NorthStar trims | » CARGO<br>2890032<br>POLARIS XPEDITION ADV 5 '24<br>Front & Rear Kit (2885169) required, sold separately |
|--|---|---|

One ROPS Extension Harness (2885170) required for any light configuration on Premium trims, sold separately.

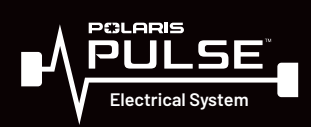

ELECTRICAL INSTALLS MADE EASY WITH **PLUG & PLAY**

**POLARIS ENGINEERED ADVANTAGES**



- To install accessories, simply plug the harness into the Polaris PULSE bar
- No need to remove nuts and stack wire terminals like a three-post terminal setup
- By plugging in your accessories, a secure connection is guaranteed every time

Look for **PULSE** to identify Polaris PULSE ready accessories

\*Check with your local dealer for availability.



# VEHICLE PROTECTION



## BUMPERS

### FRONT



### REAR



#### HD FRONT BUMPER

- High-strength steel provides additional protection to the front of the vehicle
- Compatible with the Pro HD High-Mounted 6,000 LB Winch (2884839) and RIGID® Driving LED Lights (2889731), sold separately

» 2884494-458

POLARIS XPEDITION XP/5 '24  
POLARIS XPEDITION ADV/5 '24

#### HD REAR BUMPER

- Durable, powder-coated 1.75" tube steel
- Easily attaches to the integrated mounting location

» 2889331-458

POLARIS XPEDITION XP/5 '24  
POLARIS XPEDITION ADV/5 '24

#### REAR BUMPER

- A full-coverage sheet metal face provides additional protection to the rear of the vehicle and the muffler cover

» 2884498-458

POLARIS XPEDITION XP/5 '24  
POLARIS XPEDITION ADV/5 '24

## ROCK SLIDERS

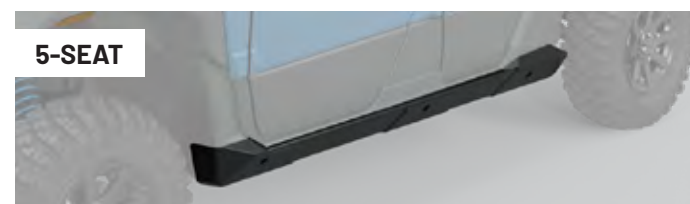

2-SEAT

5-SEAT

#### LOW PROFILE ROCK SLIDERS

- Heavy gauge plate steel
- Seamless integration along vehicle contours

» 2-SEAT • 2884496-458

POLARIS XPEDITION XP '24  
POLARIS XPEDITION ADV '24

» 5-SEAT • 2889357-458

POLARIS XPEDITION XP 5 '24  
POLARIS XPEDITION ADV 5 '24



2-SEAT

5-SEAT

#### HD EXTREME KICK-OUT ROCK SLIDERS

- 14-gauge, 0.75" steel tube for superior durability

» 2-SEAT • 2884495-458

POLARIS XPEDITION XP '24  
POLARIS XPEDITION ADV '24

» 5-SEAT • 2884497-458

POLARIS XPEDITION XP 5 '24  
POLARIS XPEDITION ADV 5 '24

## FENDER FLARES



#### FULL COVERAGE FENDER FLARES

- Provide additional coverage by helping keep mud and other debris from flying into the cab
- Installs with the stock fender flares and adds factory styling to your ride
- Recommend when using the vehicle with snow tracks

» 2890638

POLARIS XPEDITION XP/5 '24  
POLARIS XPEDITION ADV/5 '24

## A-ARM GUARDS



FRONT

REAR

#### A-ARM GUARDS

- Provides protection to your vehicle without affecting performance
- A lightweight, poly construction offers strength and durability
- Simple, secure installation to the steel brackets

» FRONT • 2884714

POLARIS XPEDITION XP/5 '24  
POLARIS XPEDITION ADV/5 '24

» REAR • 2884715

POLARIS XPEDITION XP/5 '24  
POLARIS XPEDITION ADV/5 '24



# STORAGE

PACK FOR EVERY ADVENTURE

Equip your Polaris XPEDITION with Polaris Engineered storage accessories to pack all your essentials for every outdoor adventure. The versatile lineup includes all-new, easy-to-install Lock & Ride MAX accessories — like a bed extender, spare tire carrier and rear storage box — that offer limitless ways to customize your vehicle's storage capabilities.



Plus, we've partnered with Rhino-Rack® to deliver premium roof and bed rack solutions. These racks deliver increased storage capacity and allow you to elevate your adventure with item-specific mounts to transport items including kayaks, fishing rods, traction boards and more.



## INTRODUCING



The all-new Lock & Ride MAX system has storage and adaptability built into its DNA. Our next generation of Polaris Lock & Ride technology brings with it an entirely new system of purpose-built accessories and attachments, resulting in an endlessly customizable and remarkably intuitive platform. This means you can go further, push harder and do more than ever before. With virtually limitless configurations and no tools required, you have the freedom to reconfigure on the fly and spend more time doing the things you love.



### HOW IT WORKS



1. Choose accessories



2. Position on the vehicle



3. Lock accessories into place



4. Reconfigure as needed



# STORAGE



See what storage accessories are compatible with the Lock & Ride MAX rail system and the Rhino-Rack® roof / bed rack system.

PN	PRODUCT	LOCK & RIDE MAX	RHINO-RACK®
2890645	Awning	✓	✓
2889526-458	Kolpin Stronghold Auto-Latch Mount	✓	✓
2890646	MAXTRAX™ Traction Boards & Mounts	✓	✓
2889622	Lock & Ride MAX Bed Rail Kit	✓	
2889621	Lock & Ride MAX Bed Rail Kit	✓	
2889623	Lock & Ride MAX Rear Floor Rail Kit	✓	
2890091-458	Lock & Ride MAX Bed Extender	✓	
2889468-458	Lock & Ride MAX Cross Bed Bar	✓	
2890894	Lock & Ride MAX D-Rings	✓	✓
2889649	Lock & Ride MAX Finish Washer Kit	✓	
2890708	Lock & Ride MAX Rail Cover Kit	✓	✓
2884712	Lock & Ride MAX Rear Storage Box	✓	
2889336-458	Lock & Ride MAX Spare Tire Carrier	✓	
2889884	Rhino-Rack™ Accessory Bars		✓
2889531	Rhino-Rack™ Cargo Corner Brackets		✓
2889527	Rhino-Rack™ Eyelet Tie-Downs	✓	✓
2889729	Rhino-Rack™ Fishing Rod Holder		✓
2889337	Rhino-Rack™ Gun Mounting Bracket	✓	✓
2889533	Rhino-Rack™ High-Lifting Jack Mount		✓
2889883	Rhino-Rack™ J-Style Kayak Holder		✓
2889881	Rhino-Rack™ 200 L Luggage Bag		✓
2889528	Rhino-Rack™ Multi-Purpose Tool Holder	✓	✓
2889590	Rhino-Rack™ Rear Bed Rack/Roof Rack, Small		✓
2889237	Rhino-Rack™ Roof Rack, Large		✓
2889529	Rhino-Rack™ Spare Tire Holder		✓
2889530	Rhino-Rack™ Traction Board Mounts		✓



## A SPARE TIRE CARRIER

- Holds up to a 30" tire
- Mounts directly to factory bed rails (ADV models only) or the Cross Bed Bar (2889468-458), sold separately

» 2889336-458

POLARIS XPEDITION XP/5 '24  
POLARIS XPEDITION ADV/5 '24  
XP models: Cross Bed Bar: (2889468-458) required, sold separately



## B CROSS BED BAR

- Provides additional mounting options with Lock & Ride MAX accessories
- Can be used as a divider in the vehicle bed
- Quick, toolless install with Lock & Ride MAX slide locks

» 2889468-458

POLARIS XPEDITION XP/5 '24  
POLARIS XPEDITION ADV/5 '24



## C BED EXTENDER

- Add 30% more cargo space with the rear gate lowered and the extender installed
- Durable, powder-coated tube steel

» 2890091-458

POLARIS XPEDITION XP/5 '24  
POLARIS XPEDITION ADV/5 '24  
NOT COMPATIBLE WITH ADV NORTHSTAR

## D HEADACHE RACK

- Fixed rear panel protection with integrated molle attachment system

» 2889409-458

POLARIS XPEDITION XP/5 '24



## E REAR STORAGE BOX

- Water-resistant design and access door seals to keep gear protected from the elements
- Features one large door and two smaller doors for multiple access options

» 2884712

POLARIS XPEDITION XP/5 '24  
POLARIS XPEDITION ADV/5 '24



## F HOOD RACK

- Increases load-carrying capacity while also protecting against brush and debris
- 100 LB weight capacity

» STOCK BUMPER • 2889387

POLARIS XPEDITION XP/5 '24  
POLARIS XPEDITION ADV/5 '24

» HD BUMPER • 2884503

POLARIS XPEDITION XP/5 '24  
POLARIS XPEDITION ADV/5 '24



## G ACCESSORY RAILS

- Additional Lock & Ride MAX rails for expanded storage capacity
- Each kit includes two rails

» BED RAIL KIT  
2889622

POLARIS XPEDITION XP/5 '24

» BED RAIL KIT  
2889621

POLARIS XPEDITION ADV/5 '24

» REAR FLOOR RAIL KIT  
2889623

POLARIS XPEDITION XP/5 '24  
POLARIS XPEDITION ADV/5 '24



## H RAIL COVER KIT

- Rubber covers to protect your Lock & Ride MAX rails from dirt and debris
- Kit includes eight strips

» 2890708

POLARIS XPEDITION XP/5 '24  
POLARIS XPEDITION ADV/5 '24



## I FINISH WASHER KIT

- Replaces any Lock & Ride MAX quick attachment to provide semi-permanent mounting and added security
- Kit includes two finish washers

» 2889649

POLARIS XPEDITION XP/5 '24  
POLARIS XPEDITION ADV/5 '24



## J REAR WINDOW MOLLE PANELS

- Attach to the rear side windows of ADV models
- Mount your molle compatible bags or items
- Doubles as a glass protector when used with glass side panels

» 2889478

POLARIS XPEDITION ADV/5 '24



## K KOLPIN STRONGHOLD AUTO-LATCH MOUNT

- Mount a Stronghold Gun Boot (sold separately) and safely transport firearms without taking up cargo bed space

» 2889526-458

POLARIS XPEDITION XP/5 '24  
POLARIS XPEDITION ADV/5 '24  
Shown with Kolpin Stronghold Gun Boot XL (2882036), sold separately



## L D-RINGS

- Steel rings securely attach to the Lock & Ride MAX rail system with a wing nut style bolt
- Easily move along the rails to strap down items/loads in the vehicle bed

» 2890894

POLARIS XPEDITION XP/5 '24  
POLARIS XPEDITION ADV/5 '24

See P. 40 for more hunt information

ACCESSORIES

WINDSHIELDS, REAR PANELS & DOORS

CAB COMFORT

VEHICLE PROTECTION

STORAGE

OVERLANDING/CAMPING & RECOVERY

AUDIO & CONNECTED TECHNOLOGY

HUNT/COOLERS

LIGHTING

WHEELS & TIRES

WINCHES, PLOWES & TRACKS



# STORAGE | RHINO-RACK®

## BRING IT ALL. BRING IT ON.

From opposite sides of the globe, some of the most capable machines in the off-road world meet a trusted outdoor adventure brand to deliver industry-exclusive, purpose-built roof racks, bed racks and attachments that help Polaris XPEDITION riders get the most out of their next adventure.

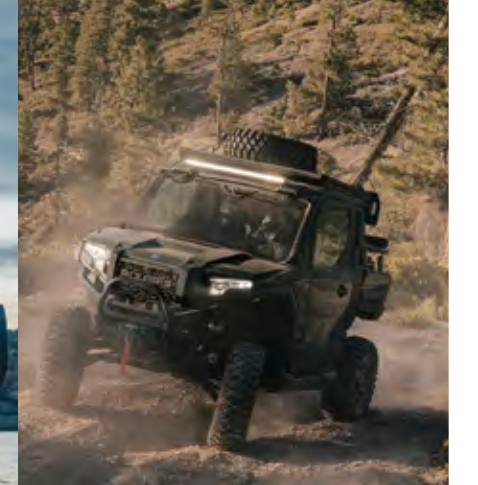

## ACCESSORIZE IT



### SPARE TIRE HOLDER

- Transport a spare tire outside the vehicle
- Easily mounts to the Rhino-Rack® Rear Bed Rack (2889590), sold separately

» 2889529  
POLARIS XPEDITION XP/5 '24  
POLARIS XPEDITION ADV/5 '24



### HIGH-LIFTING JACK MOUNT

- Simple, quick install with durable brackets
- Rugged, non-corrosive powder-coated steel stands up to the harshest conditions

» 2889533  
POLARIS XPEDITION XP/5 '24  
POLARIS XPEDITION ADV/5 '24



### FISHING ROD HOLDER

- Convenient, locking carrier can transport five fishing rods safely and securely on a roof rack
- Doubles as a ski/snowboard carrier

» 2889729  
POLARIS XPEDITION XP/5 '24  
POLARIS XPEDITION ADV/5 '24



### 200 L LUGGAGE BAG

- Carry bulky, lightweight gear in this tear- and weather-resistant canvas bag

» 2889881  
POLARIS XPEDITION XP/5 '24  
POLARIS XPEDITION ADV/5 '24



### J-STYLE KAYAK HOLDER

- Transport a kayak or canoe on the roof of your vehicle

» 2889883  
POLARIS XPEDITION XP/5 '24  
POLARIS XPEDITION ADV/5 '24  
Accessory Bars (2889884) required, sold separately



### ACCESSORY BARS

- Offers horizontal fitment to allow other accessories to be attached to the Rhino-Rack® platforms

» 2889884  
POLARIS XPEDITION XP/5 '24  
POLARIS XPEDITION ADV/5 '24

## PICK YOUR RACK



### REAR BED RACK / ROOF RACK, SMALL

- Install either in the bed or on the roof of the vehicle (mounts sold separately)
- A durable backbone ensures a secure vehicle attachment
- An innovative attachment system allows for easy accessory install
- 75 LB weight capacity per rack

» 2889590  
POLARIS XPEDITION XP/5 '24  
Small Roof Rack is not compatible with XP 5

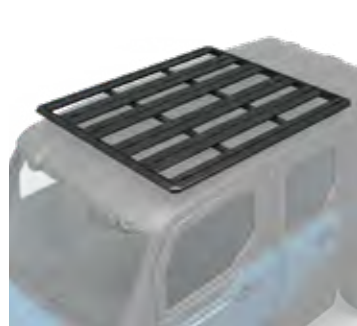

### ROOF RACK, LARGE

- Install on the roof of the vehicle (mount sold separately)
- A durable backbone ensures a secure vehicle attachment
- An innovative attachment system allows for easy accessory install
- 150 LB weight capacity

» 2889237  
POLARIS XPEDITION XP/5 '24  
POLARIS XPEDITION ADV/5 '24



### ROOF RACK MOUNT

- » SMALL • 2889450  
POLARIS XPEDITION XP '24
- » LARGE • 2889451  
POLARIS XPEDITION ADV '24

» LARGE • 2889452 [NOT SHOWN]  
POLARIS XPEDITION XP/5 '24  
POLARIS XPEDITION ADV/5 '24



### REAR BED RACK MOUNT

- » 2889453  
POLARIS XPEDITION XP/5 '24

## PICK YOUR MOUNT



### GUN MOUNTING BRACKET

- Mount Kolpin Stronghold Gun Boots to Rhino-Rack® systems when paired with Auto-Latch Mount (2836942), sold separately

» 2889327  
POLARIS XPEDITION XP/5 '24  
POLARIS XPEDITION ADV/5 '24

See P. 40 for more hunt information



### EYELET TIE-DOWNS

- Attach in multiple locations on the platform for additional tie-down points
- Anti-corrosive, galvanized steel for heavy duty strength
- Includes one set with hardware (straps not included)

» 2889527  
POLARIS XPEDITION XP/5 '24  
POLARIS XPEDITION ADV/5 '24



### MULTI-PURPOSE TOOL HOLDER

- Carry and protect tools, paddles and more
- Ratchet-locking mechanism for quick release and rubber inserts that secure gear into place

» 2889528  
POLARIS XPEDITION XP/5 '24  
POLARIS XPEDITION ADV/5 '24



### TRACTION BOARD MOUNTS

- Strong, durable and easy to attach
- Traction boards sold separately

» 2889530  
POLARIS XPEDITION XP/5 '24  
POLARIS XPEDITION ADV/5 '24



### CARGO CORNER BRACKETS

- Mount a NorthStar cooler or toolbox to the platform and save space inside the vehicle (straps not included)
- A unique, anti-rotation nut offers maximum security

» 2889531  
POLARIS XPEDITION XP/5 '24  
POLARIS XPEDITION ADV/5 '24

ACCESSORIES

WINDSHIELDS, REAR PANELS & DOORS

CAB COMFORT

VEHICLE PROTECTION

STORAGE

OVERLANDING/ CAMPING & RECOVERY

AUDIO & CONNECTED TECHNOLOGY

HUNT/COOLERS

LIGHTING

WHEELS & TIRES

WINCHES, PLOWES & TRACKS



# OVERLANDING/CAMPING



# RECOVERY



ACCESSORIES

WINDSHIELDS, REAR PANELS & DOORS

CAB COMFORT

VEHICLE PROTECTION

STORAGE

OVERLANDING/CAMPING & RECOVERY

AUDIO & CONNECTED TECHNOLOGY

HUNT/COOLERS

LIGHTING

WHEELS & TIRES

WINCHES, PLOWS & TRACKS



## ROOFTOP TENT

- Accommodates up to three people
  - Made from a durable, poly/cotton ripstop with a water-resistant coating
  - Includes inside pockets, inside rope light, two boot bags and a foam mattress
- » 2890560  
POLARIS XPEDITION XP 5 '24  
POLARIS XPEDITION ADV/5 '24  
Large Roof Rack (2889237) required, sold separately



## AWNING\*\*

- Provides quick shade when out on the trail
  - Lock & Ride MAX technology allows for easy on/off mounting to the vehicle roof or Rhino-Rack® Roof Rack (2889237), sold separately
- » 2890645  
POLARIS XPEDITION XP 5 '24  
POLARIS XPEDITION ADV/5 '24



## HIGH RISE INTAKES\*

- Optimizes air-induction performance and improves engine abilities in dusty conditions
  - Intakes do not increase the water fording line of the vehicle
  - Includes left and right intakes
- » 2890693  
POLARIS XPEDITION XP/5 '24  
POLARIS XPEDITION ADV/5 '24



## MAXTRAX® TRACTION BOARDS & MOUNTS

- Fiber-reinforced, engineering-grade nylon construction that won't break, crack or stress during use
  - All boards are jack-compatible, can be used as a leveling solution and work well with the Rooftop Tent (2890560), sold separately
- » 2890646  
POLARIS XPEDITION XP/5 '24  
POLARIS XPEDITION ADV/5 '24



## RECOVERY SHACKLES

- Provides ideal tie down points for recovery or securing the vehicle on a trailer
  - Installs on the stock bumper or accessory HD Front Bumper (2884494-458), sold separately
  - Rubber dampeners help ensure a quiet ride
- » 2890542  
POLARIS XPEDITION XP/5 '24  
POLARIS XPEDITION ADV/5 '24



## 36" HIGH-LIFTING JACK

- Assists with trailside repairs or to gain leverage for getting your vehicle unstuck
  - Lightweight at under 30 LBS
  - Stores easily with a Rhino-Rack® High-Lifting Jack Mount (2889533), sold separately
- » 2889508  
POLARIS XPEDITION XP/5 '24  
POLARIS XPEDITION ADV/5 '24  
[See P. 33 for mounting solutions](#)



## TRAILSIDE RECOVERY KIT

- Portable Air Compressor (060-DAP)
  - 1,000 amp Ultrasafe Lithium Jump Pack (2830547)
  - Recovery Strap (2884033)
  - Replacement Drive Belt (321186)
- » 3880060

\*Fall availability.

\*\*Check with your local dealer for availability.

Make sure vehicle is level, gear selector is in PARK and the wheels are chocked when the tent is deployed.



# AUDIO

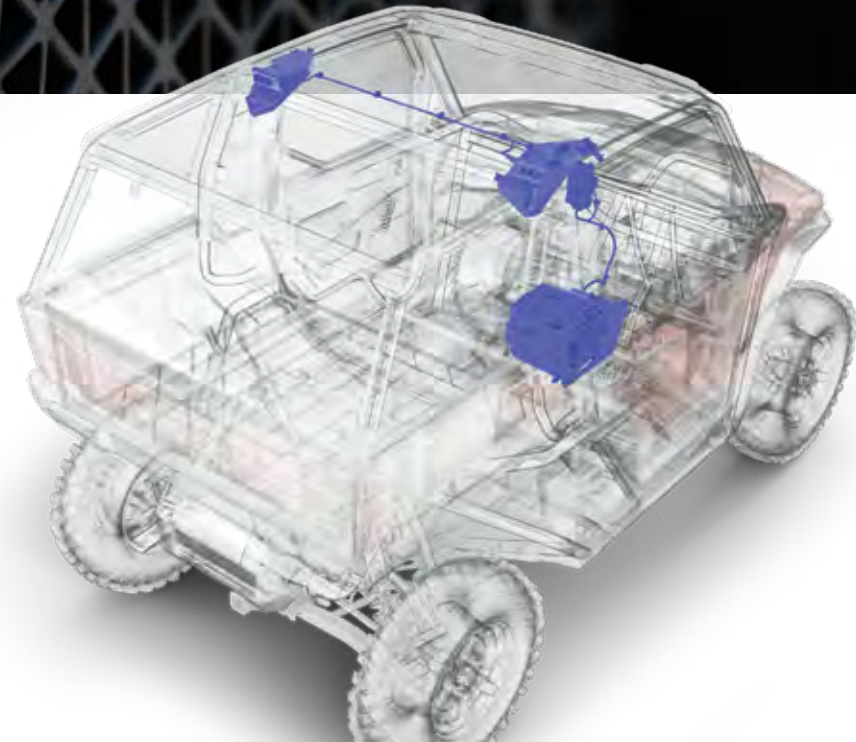

JBL® partnered with Polaris to create the highest performing audio system, specifically designed for Polaris XPEDITION. Purpose-built to stand up to any outdoor environment and developed to deliver on your next adventure.



- JBL® TRAIL PRO 4100 AUDIO UPGRADE (PREMIUM TRIMS ONLY)** 
- 400 Watt 10" subwoofer
  - Two 45 Watt 6" stadium speakers
  - 200 Watt Amp
  - Compatible with the stock JBL® source unit or the RIDE COMMAND 7" Display (2884072), sold separately
- |   |  |
|---|--|
| <p>» <b>STOCK JBL® SOURCE UNIT • 2884481</b></p> <p><small>POLARIS XPEDITION XP/5 '24<br/>POLARIS XPEDITION ADV/5 '24<br/>PREMIUM TRIMS ONLY<br/>ROPS Extension Harness (2885170) required, sold separately</small></p> | <p>» <b>RIDE COMMAND UPGRADE • 2890118</b></p> <p><small>Includes 7" Display Mount<br/>POLARIS XPEDITION XP/5 '24<br/>POLARIS XPEDITION ADV/5 '24<br/>PREMIUM TRIMS ONLY<br/>ROPS Extension Harness (2885170) &amp; 7" Display Powered by RIDE COMMAND (2884072) required, sold separately</small></p> |
|---|--|



# CONNECTED TECHNOLOGY

GO REMOTE.  
STAY CONNECTED.



POLARIS RIDECOMMAND +			
VEHICLE OWNERSHIP	GARAGE	✓	✓
	WARRANTY STATUS	✓	✓
	MAINTENANCE TRACKING	✓	✓
	ISSUE DIAGNOSTIC	✓	✓
RIDING FEATURES	VEHICLE HEALTH	✓	✓
	COMMUNITY	✓	✓
	CONTENT SHARING	✓	✓
	RIDE PLANNING	✓	✓
	WAYPOINTS	✓	✓
	RIDE TRACKING	✓	✓
SECURITY	RIDE TRACKING+	✓	✓
	GROUP RIDE	✓	✓
	GROUP RIDE+	✓	✓
	VEHICLE LOCATOR	✓	✓
LOCATION ALERTS	✓	✓	
BUMP ALERT	✓	✓	

## POLARIS RIDECOMMAND

### PLAN YOUR RIDE

Plan an epic ride with stops along the way, customize and adjust your path to maximize your route or follow turn-by-turn directions. You can even share your planned route with friends.

### FOLLOW THE GROUP

With Group Ride, you can ride at your own speed and keep fellow riders in sight on your map screen, even if you get split up. Because rides are meant to be shared.

### WORK SMARTER

Plow Mode automatically raises and lowers the plow depending on the gear you're in, so that you can get your work done quicker.

### DISCOVER NEW TRAILS

With over 1,000,000 miles of trails available offline, you'll have the confidence to explore further, whether you have cellular coverage or not.

#### 7" DISPLAY POWERED BY RIDE COMMAND\*

Bright, 7" touchscreen visible in all conditions

##### Camera Integration

Navigate with full view of your surroundings. Use the integrated rear camera to see others behind you while riding.

##### Personalized Audio Experience

Seamlessly pair your display via Bluetooth\* to wirelessly stream music and stay connected with call and text alerts.



##### Configurable Gauges

Customize your ride experience with elevation, travel direction, fuel level and more to create relevant screens for you.

» 2884072

POLARIS XPEDITION XP/5 '24  
POLARIS XPEDITION ADV/5 '24

LEARN MORE AND DOWNLOAD AT  
[RIDECOMMAND.POLARIS.COM](https://ridecommand.polaris.com)



## INTRODUCING POLARIS RIDECOMMAND+

### THE LATEST IN INDUSTRY-LEADING CONNECTED VEHICLE TECHNOLOGY

Vehicle location and health in the palm of your hand. Over the air updates with new feature releases.



VEHICLE LOCATION



LOCATION ALERTS



VEHICLE HEALTH



RIDE TRACKING+ & GROUP RIDE+



ISSUE DIAGNOSTICS



MAINTENANCE REMINDERS

#### RIDE COMMAND+ CONNECTED VEHICLE

##### » PLUG-IN • 2890039

POLARIS XPEDITION XP/5 '24  
POLARIS XPEDITION ADV/5 '24  
STANDARD ON NORTHSTAR TRIMS

##### » INSTALL KIT • 2889796

POLARIS XPEDITION XP/5 '24  
POLARIS XPEDITION ADV/5 '24  
STANDARD ON NORTHSTAR TRIMS



#### VOYAGER PRO KIT, UTV

Bright, 4" touchscreen visible in all conditions

Compatible with RIDE COMMAND

##### Pre-Loaded Base Maps

The map screen is enabled with base maps, topography lines, hill shading and select trails. Record or load GPS trails/riding areas and transfer to a PC.

##### Buddy Tracking

Track up to 20 group members no matter what type of vehicle they are riding.

##### Bluetooth\* Enabled

Bluetooth\* enabled for intercom, phone and media controls. Play songs from your phone or MicroSD card using a Bluetooth\* headset, speaker or intercom. Two phones and two headsets can be connected at the same time.

LEARN MORE AT  
[TRAILTECH.NET](https://trailtech.net)

» 922-125

AVAILABLE AT YOUR LOCAL DEALER OR ONLINE AT TRAILTECH.NET

ACCESSORIES

WINDSHIELDS, REAR PANELS & DOORS

CAB COMFORT

VEHICLE PROTECTION

STORAGE

OVERLANDING/CAMPING & RECOVERY

AUDIO & CONNECTED TECHNOLOGY

HUNT/COOLERS

LIGHTING

WHEELS & TIRES

WINCHES, PLOWES & TRACKS

\*Due to ongoing supply chain issues, there may be delayed or limited availability of this product as an accessory add-on.



# HUNT



**KOLPIN**  
OUTDOORS

**PROTECTING YOUR  
ESSENTIAL GEAR SINCE 1943**

## KOLPIN STRONGHOLD CASES & MOUNT



### KOLPIN STRONGHOLD GUN BOOT XL

- Includes zippered internal liner
- Lockable
- » 2882036
- POLARIS XPEDITION XP/5 '24  
POLARIS XPEDITION ADV/5 '24
- Auto-Latch Mount (2889526-458 or  
2636942) required, sold separately



### KOLPIN STRONGHOLD GUN BOOT L

- » 2882426
- POLARIS XPEDITION XP/5 '24  
POLARIS XPEDITION ADV/5 '24
- Auto-Latch Mount (2889526-458 or  
2636942) required, sold separately



### LR LOCK & RIDE MAX KOLPIN STRONGHOLD AUTO-LATCH MOUNT

- » 2889526-458
- POLARIS XPEDITION XP/5 '24  
POLARIS XPEDITION ADV/5 '24

### AUTO-LATCH MOUNT

- » 2636942
- POLARIS XPEDITION XP/5 '24  
POLARIS XPEDITION ADV/5 '24

## RHINO-RACK® MOUNT



### RHINO-RACK® GUN MOUNTING BRACKET

- Mount Kolpin Stronghold Gun Boots to Rhino-Rack® systems when paired with Auto-Latch Mount (2636942), sold separately
- » 2889327
- POLARIS XPEDITION XP/5 '24  
POLARIS XPEDITION ADV/5 '24

See P. 32 for more Rhino-Rack® products

## KOLPIN RHINO GRIPS IDEAL FOR BOWS & UNCASSED GUNS



### LR LOCK & RIDE MAX RHINO GRIP PRO

- » 2884107
- POLARIS XPEDITION XP/5 '24  
POLARIS XPEDITION ADV/5 '24



### LR LOCK & RIDE MAX RHINO GRIP XLR

- » 2881574
- POLARIS XPEDITION XP/5 '24  
POLARIS XPEDITION ADV/5 '24



### LR LOCK & RIDE MAX RATCHETING RHINO GRIP

- » 2881575
- POLARIS XPEDITION XP/5 '24  
POLARIS XPEDITION ADV/5 '24



### LR LOCK & RIDE MAX RHINO GRIP XLR - DOUBLES

- » 2889166
- POLARIS XPEDITION XP/5 '24  
POLARIS XPEDITION ADV/5 '24

All Kolpin Rhino Grips are Lock & Ride MAX / Lock & Ride compatible and come with required mounting hardware.

ACCESSORIES

WINDSHIELDS, REAR  
PANELS & DOORS

CAB COMFORT

VEHICLE  
PROTECTION

STORAGE

OVERLANDING/  
CAMPING & RECOVERY

AUDIO & CONNECTED  
TECHNOLOGY

HUNT/COOLERS

LIGHTING

WHEELS & TIRES

WINCHES, PLOW  
& TRACKS



# COOLERS

**POLARIS**  
**NORTHSTAR**  
**COOLER**

MADE FOR RIDERS.  
BUILT FOR LIFE.

30, 60 & 105  
QUART FEATURES



ComfortCarry  
Handles



TravelLock  
System



EasyOut  
Drain System



NoSlip  
Rubber Feet



PolarWall  
Insulation



IceLock  
Seal

POLARIS NORTHSTAR COOLERS CAN SURVIVE JUST ABOUT ANYTHING - FROM EXTREME HEAT TO A NASTY TUMBLE OFF A VEHICLE.



105 QUART

■ ■ ■ SAGEBRUSH GREEN • 2890707  
GRAPHITE • 2883426

ACCESSORIES

WIRE BASKET • 2883648  
DIVIDER (1) • 2883468  
WHEELS • 2883967

Divider

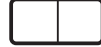

1 way to  
partition



60 QUART

■ ■ ■ SAGEBRUSH GREEN • 2890706  
GRAPHITE • 2883425

ACCESSORIES

WIRE BASKET • 2882185  
DIVIDERS (2) • 2882184  
SEAT CUSHION • 2882179  
WHEELS • 2882180

Dividers



2 ways to  
partition



30 QUART

■ ■ ■ SAGEBRUSH GREEN • 2890705  
GRAPHITE • 2883424

ACCESSORIES

WIRE BASKET • 2882438  
DIVIDER (1) • 2882186

Divider



1 way to  
partition



15 QUART

■ ■ ■ SAGEBRUSH GREEN • 2890704  
GRAPHITE • 2883968



20 QUART  
SOFT-SIDED COOLER

GRAPHITE • 2889285



HOLDS ICE  
FOR AGES

BECAUSE JUST ANY COOLER  
WON'T CUT IT OUT THERE.

You need something rugged and reliable. A cooler purpose built to handle the challenges of the off road—while keeping your provisions on ice for days on end. Because out here, there are no ice machines, and you just left the last one in your dust. So, load it up. Lock it in. And know your NorthStar cooler is staying put—giving you a few extra days of ice time to enjoy the wild.

## ESSENTIAL ACCESSORIES SO YOUR COOLER WORKS AS HARD AS YOU DO

WIRE BASKET



DIVIDERS Doubles as cutting board

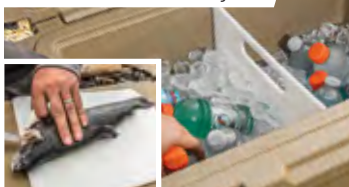

SEAT CUSHION



WHEELS



TUMBLER



20 OZ • 2883393

ACCESSORIES

WINDSHIELDS, REAR  
PANELS & DOORS

CAB COMFORT

VEHICLE  
PROTECTION

STORAGE

OVERLANDING/  
CAMPING & RECOVERY

AUDIO & CONNECTED  
TECHNOLOGY

HUNT/COOLERS

LIGHTING

WHEELS & TIRES

WINCHES, PLOW  
& TRACKS



# LIGHTING



**RIGID**

## 50" CURVED RDS SR-SERIES LIGHT BAR

A trusted name in the off-road lighting industry, RIGID® delivers unmatched technology and superior performance.

## FROM DUSK 'TIL DAWN

Extend your ride time and be more visible to others with the brightest light bars in the industry.



**RIGID**  
D-SERIES POD  
LIGHTS & MOUNTS

**RIGID**  
SR-M-SERIES PRO  
DRIVING LED LIGHTS  
2889731



**RIGID**  
SCENE LIGHTS  
2884783

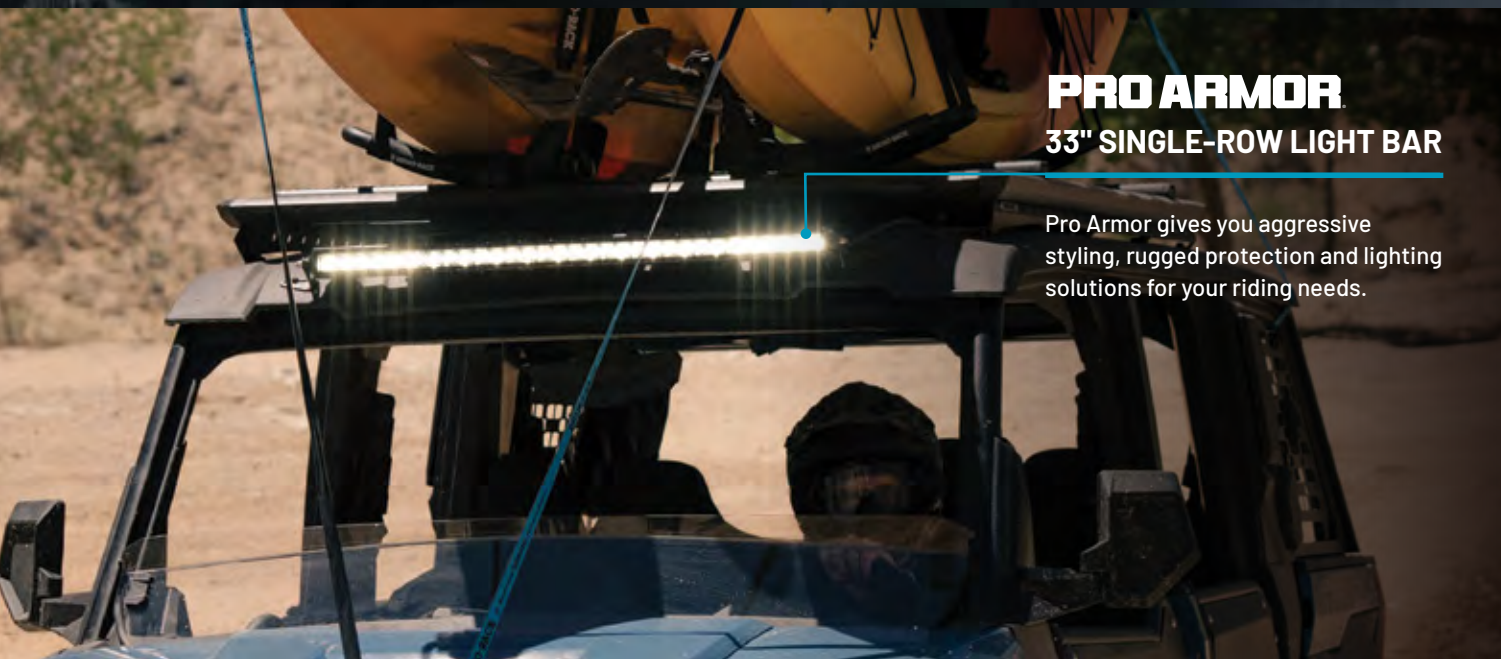

## PRO ARMOR 33" SINGLE-ROW LIGHT BAR

Pro Armor gives you aggressive styling, rugged protection and lighting solutions for your riding needs.





**POLARIS ENGINEERED ADVANTAGES**

**MOUNTS PERFECTLY**  
Designed for your Polaris Engineered bumper, roof or other mounting point

**MAX PERFORMANCE**  
Validated to work as hard as your machine does

**DOESN'T OVERTAX**  
Trust it to work when you need it to



**ADVANCED TECH**

RIGID® lights are driven by Aluminum PCB Smart Boards®, 6063-T5 aircraft aluminum extruded housings and Tiger Drylac® UV protection polyester powdercoating.

**EXCLUSIVE OPTICS**

RIGID® invests heavily in optical science and has patented multiple optics and optics systems, maximizing light output and efficiency.

**RIGID® LIMITED LIFETIME WARRANTY**

If you own a RIGID® light and it breaks, we will replace or repair it for life.\*

**RUGGED CONSTRUCTION**

Pro Armor lights are designed to be big and beefy with an aggressive style all their own, and housed in IP67 marine-grade rated UV polyester powdercoating.

**MASSIVELY BRIGHT**

Pro Armor builds bright lights designed for any riding experience. All that power is directed through heat dissipating aluminum for streamlined heat management.

LIGHT BAR TYPES



**SR-SERIES PRO**

Sleek, powerful, low-profile (under 2" tall). Lights extreme distances with low energy usage.

Available in Driving, 10", 32" & 50"



**D-SERIES PRO**

Compact to fit almost anywhere with high output and low energy usage.

Available in Driving, Flood & Spot



**DUAL-ROW LED**

The most spread and farthest illumination downrange. Easy to mount.

Available in Cube, 11" & 31"



**SINGLE-ROW LED**

Powerful, compact, low-profile light bars with sleek look.

Available in 11", 20", 33" & 40"



**CUBE LED**

Small size allows mounting in strategic locations for added lighting.

Available in Spot

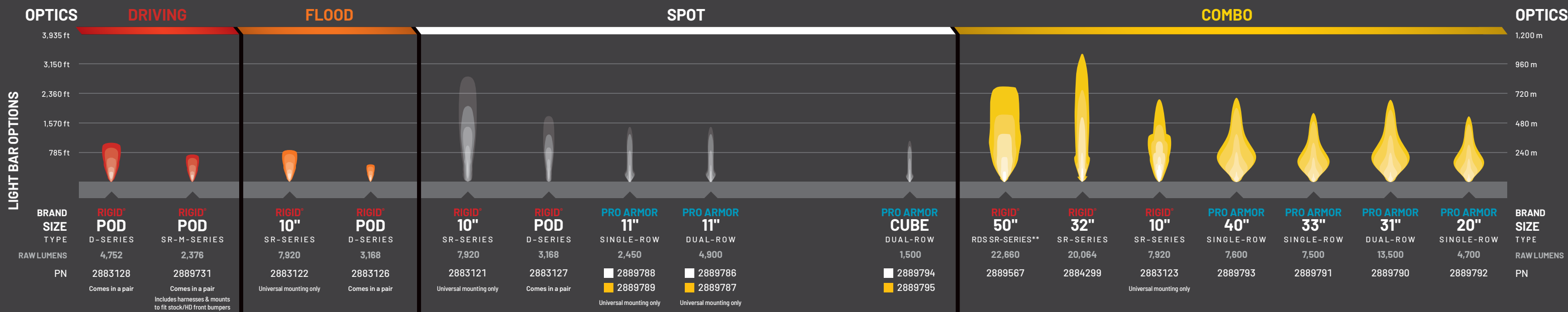

**BUILD YOUR VISION**

Consider the optics, angle & how you will use your vehicle to choose the right light or set of lights.

OPTICS LIGHT ANGLE	ACCENT	DRIVING (45°)	FLOOD (25°)	SPOT (10°)	COMBO (25°/10°)
DRIVING SPEED	All	Slow to medium	Slow to medium	High	All
BEAM	Diffused glow	Extra-wide	Wide/shorter	Concentrated/long	Inner spot & outer flood
RECOMMENDED MOUNTING	Low/wheel well	All points	Low/rear	High points	All points
TERRAIN & RIDING STYLE	Added style & personalization in any terrain	All riding & utility	Wide-open terrain or trails & utility	Trail & tight conditions	All riding & utility

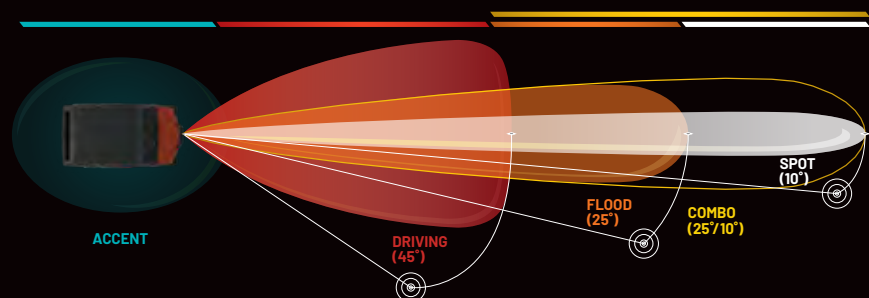

**ADD MOUNTS & HARNESSES TO INSTALL YOUR LIGHTS**

TYPE OF LIGHT	LIGHT LOCATION: BUMPER	LIGHT LOCATION: FRONT ROOF	LIGHT LOCATION: REAR ROOF
POD/CUBE LIGHTS	FRONT HD BUMPER CUBE LIGHT MOUNTS 2889820 FRONT HD BUMPER CUBE LIGHT HARNESS + SWITCH** 2889885	FRONT ROOF CUBE LIGHT MOUNTS 2889849 FRONT ROOF CUBE LIGHT HARNESS + SWITCH 2889891	REAR ROOF CUBE LIGHT HARNESS + SWITCH 2889730 Universal mounting with lights
20"-40" LIGHT BARS	N/A	FRONT ROOF LIGHT BAR MOUNTS 2889643 FRONT ROOF LIGHT BAR HARNESS 2889892	REAR ROOF LIGHT BAR HARNESS 2889853 Universal mounting with lights
50" LIGHT BAR**	N/A	50" LIGHT BAR HARNESS** 2889591 Mounts included with light bar	N/A



**RIGID® SCENE LIGHTS**

- Provides a "soft" aerial light to increase visibility around the camp or jobsite
- Includes two side-mounted lights, one rear-mounted light and system wiring harness

» 2884783

POLARIS XPEDITION XP/5 24  
POLARIS XPEDITION ADV/5 24



\* If RIGID® determines, in its sole discretion, that your product is defective in material or workmanship, RIGID® will honor your warranty claim. In some cases the product will be replaced, depending on the specific timeframe of the purchase. If the product is repaired, all parts, labor, and return shipping may be covered by RIGID®.

\*\*Check with your local dealer for availability.

▲ No battery connection cables required on any Polaris XPEDITION.

**PULSE** All RIGID® and Pro Armor lights are Polaris PULSE ready.

**SHOP & VERIFY VEHICLE FITMENT AT**  
[POLARIS.COM/SHOPXPEDITION](http://POLARIS.COM/SHOPXPEDITION)

ACCESSORIES

WINDSHIELDS, REAR PANELS & DOORS

CAB COMFORT

VEHICLE PROTECTION

STORAGE

OVERLANDING/ CAMPING & RECOVERY

AUDIO & CONNECTED TECHNOLOGY

HUNT/COOLERS

LIGHTING

WHEELS & TIRES

WINCHES, PLOWES & TRACKS



# WHEELS & TIRES

## SUPERIOR PERFORMANCE & DURABILITY

### LIFELONG PERFORMANCE

- Every tire is designed and constructed with longevity in mind
- 3,000+ mile rated (4,828 kilometers)

### PREMIUM PROTECTION

- Pro Armor makes tires with extra protection exactly where it's needed most – the sidewall
- Triple-belted sidewalls keep your tires more resistant so you can keep going

### TOUGH TIRES

- Higher ply ratings mean added protection
- Pro Armor builds 8 or 10-ply rated tires for higher puncture-resistance

### KNOW YOUR TIRES

DIMENSIONS			USAGE	TREAD DEPTH	TIRE WEIGHT	PLY RATING	SIDEWALL BELTS	LOAD RATING
<b>30" x 10" R15</b> Part Number			FRONT/REAR	<b>30 mm</b>	<b>41 LBS</b>	<b>10</b>	<b>3</b>	<b>1,320 LBS</b>
TIRE HEIGHT	TIRE WIDTH	WHEEL DIAMETER	Where can you use the tire	Deeper treads have more grip in all conditions	A lighter tire makes for improved vehicle performance	Indicates tire puncture-resistance	Increase your resistance to sidewall punctures	How much weight can the tire handle

### KNOW YOUR TERRAIN

- |  |  |
|--|--|
|  <ul style="list-style-type: none"> <li>• Tread patterns optimized for extreme traction</li> <li>• Ideal for both hard pack &amp; loose trail</li> </ul>      |  <ul style="list-style-type: none"> <li>• Extra deep treads</li> <li>• Self-cleaning lugs</li> </ul>  |
|  <ul style="list-style-type: none"> <li>• Provides traction &amp; durability</li> <li>• Performs in hard sand, jagged rocks or any extreme terrain</li> </ul> |  <ul style="list-style-type: none"> <li>• Triple-belted sidewalls to resist puncture</li> <li>• Purpose-built, long lasting tread patterns</li> </ul> |
|  <ul style="list-style-type: none"> <li>• Flexible "grippy" tread</li> <li>• Aggressive side bite</li> </ul>  |  <ul style="list-style-type: none"> <li>• Handles extreme cold</li> <li>• Holds shape &amp; provides traction</li> </ul>                              |

### KNOW YOUR WHEELS

#### STEP 1: SELECT YOUR SERIES

5 = 50-SERIES

#### STEP 2: CHOOSE YOUR LOAD RATING

1 = <800 LBS   2 = 801 - 1,300 LBS   3 = 1,301 - 1,600+ LBS

#### STEP 3: PICK YOUR STYLE

OFFSET / BEADLOCK / COLOR

INCREASE OFFSET FROM STOCK = NARROWER STANCE  
DECREASE OFFSET FROM STOCK = WIDER STANCE

### WAYS TO SHOP >>>

### TIRES BY SIZE

#### 30"

- ATTACK 2.0
- CRAWLER AT
- CRAWLER XG
- CRAWLER XP
- CRAWLER XR
- HARVESTER
- MUD XC
- PRO RUNNER
- TREKKER

### TIRES BY TERRAIN

TRAIL	ROCK	DESERT	MUD	UTILITY	SNOW
ATTACK 2.0	ATTACK 2.0	ATTACK 2.0	MUD XC	HARVESTER	ATTACK 2.0
CRAWLER AT	CRAWLER AT	CRAWLER AT		TREKKER	HARVESTER
CRAWLER XG	CRAWLER XG	CRAWLER XG			
CRAWLER XP	CRAWLER XP	CRAWLER XP			
CRAWLER XR	CRAWLER XR	CRAWLER XR			
HARVESTER	PRO RUNNER	PRO RUNNER			
MUD XC					
PRO RUNNER					
TREKKER					

### WHEELS BY SIZE

#### 15"

#### 50-SERIES (9 TIRE OPTIONS)

- 5206
- 5302 BEADLOCK
- 5304 BEADLOCK
- 5306
- 5307
- 5307 BEADLOCK



ACCESSORIES

WINDSHIELDS, REAR PANELS & DOORS

CAB COMFORT

VEHICLE PROTECTION

STORAGE

OVERLANDING/ CAMPING & RECOVERY

AUDIO & CONNECTED TECHNOLOGY

HUNT/COOLERS

LIGHTING

WHEELS & TIRES

WINCHES, PLOWES & TRACKS



# TIRES



## PRO ARMOR CRAWLER XR

- Premium grip for all terrains, from the trail to the rocks
- Square block profile for even surface contact
- A tougher durometer than the XG to take on the toughest the trail has to offer

	TREAD DEPTH	TIRE WEIGHT	PLY RATING	SIDEWALL BELTS	LOAD RATING
15" FRONT/REAR	16 mm	37 LBS	8	3	1,280 LBS



## PRO ARMOR CRAWLER AT

- Directional tread for optimum performance
- Greater lug separation for easy mud clean out
- 8-ply, triple-belted ballistic sidewalls resist punctures

	TREAD DEPTH	TIRE WEIGHT	PLY RATING	SIDEWALL BELTS	LOAD RATING
15" FRONT/REAR	18 mm	36 LBS	8	3	1,280 LBS



## PRO ARMOR CRAWLER XG

- Built to crawl over all obstacles, both large and small
- A soft, sticky compound makes this tire ideal for both rock crawling and desert running
- 8-ply, triple-belted ballistic sidewalls resist punctures

	TREAD DEPTH	TIRE WEIGHT	PLY RATING	SIDEWALL BELTS	LOAD RATING
15" FRONT/REAR	20 mm	39 LBS	8	3	1,280 LBS



## PRO ARMOR CRAWLER XP

- Ideal for overlanding, rock crawling and desert running with a soft, sticky compound
- Built to maneuver over large and small obstacles
- 8-ply, triple-belted ballistic sidewalls with anti-puncture strength

	TREAD DEPTH	TIRE WEIGHT	PLY RATING	SIDEWALL BELTS	LOAD RATING
15" FRONT/REAR	20 mm	38 LBS	8	3	1,280 LBS



## WHAT CRAWLER ARE YOU?



### XR

#### SINGLE DUROMETER

- Smaller lug height and single durometer gives this high-speed tire added rigidity and lateral stability when cornering
- Unique lug design excels in hard-pack, fast terrain



### XG

#### DUAL-DUROMETER

- Taller lug height and dual-durometer construction
- Perfect balance between high-speed performance, durability and flex in order to grip slick rock



### AT

#### DIRECTIONAL LUG PATTERN

- The same taller lug height as Crawler XG, providing more grip and better traction
- Wider lug spacing for excellent mud clean-out



### XP

#### DUAL-DUROMETER

- Channeled outer lugs for superior handling in soft dirt and clay
- Extended side lugs for greater traction on rocks and in sand



# TIRES



## PRO ARMOR MUD XC

- Designed as the perfect mud-trail crossover for a smooth ride on the trail and aggressive traction in the mud
- Dual-compound technology with harder durometer lugs promote extended wear, increasing tire life
- 10-ply construction means added protection in the toughest terrain

		TREAD DEPTH	TIRE WEIGHT	PLY RATING	SIDEWALL BELTS	LOAD RATING
15"	30" x 10" R15 5418253	FRONT/REAR 30 mm	39 LBS	10	3	1,280 LBS



WHEEL SIZE

15"

FRONT/REAR



## PRO ARMOR HARVESTER

- All-around work horse with tread life of 5,000 miles / 8,047 km
- Tread pattern designed to withstand anything from the farmyard to the pastures and the trail
- 10-ply to carry the load day in and day out

		TREAD DEPTH	TIRE WEIGHT	PLY RATING	SIDEWALL BELTS	LOAD RATING
15"	30" x 10" R15 5417529	FRONT/REAR 16 mm	37 LBS	10	3	1,320 LBS



WHEEL SIZE

15"

FRONT/REAR



## PRO ARMOR ATTACK 2.0

- Engineered for excellent hard pack performance
- Dual-compound technology and radial construction offer performance in all terrains
- Tight thread pattern for a quieter ride

		TREAD DEPTH	TIRE WEIGHT	PLY RATING	SIDEWALL BELTS	LOAD RATING
15"	30" x 10" R15 5416345	FRONT/REAR 25 mm	38 lbs	10	3	1,235 LBS



WHEEL SIZE

15"

FRONT/REAR



## PRO ARMOR PRO RUNNER

- Designed to be lightweight, high-performance and quicker in corners/flats
- Triple-belted sidewalls offer extra protection where it's needed the most
- Lug separation provides a great grip and an easy clean in mud and sand

		TREAD DEPTH	TIRE WEIGHT	PLY RATING	SIDEWALL BELTS	LOAD RATING
15"	30" x 9" R15 5417531	FRONT/REAR 14 mm	30 LBS	8	3	1,170 LBS



WHEEL SIZE

15"

FRONT/REAR

**TIGHTER TREAD PATTERN =**  
Better traction in hard-pack

**DUAL-DUROMETER LUG =**  
Increased grip & traction in rough terrain, smoother ride in all terrain

**10-PLY RATED =**  
Increased durability

**LARGER 30" SIZE OFFERING =**  
More ground clearance & trail traction



## **NEW** PRO ARMOR TREKKER

- Specialized tread design provides a quiet ride
- Graduated lug depth maximizes the contact patch for ultimate predictability
- 8-ply, triple belted nylon construction

		TREAD DEPTH	TIRE WEIGHT	PLY RATING	SIDEWALL BELTS	LOAD RATING
15"	30" x 10" R15 5418676	FRONT/REAR 11-17mm graduated	34 LBS	8	3	1,235 LBS



WHEEL SIZE

15"

FRONT/REAR



# WHEELS

## KNOW YOUR TERRAIN



- Tread patterns optimized for extreme traction
- Ideal for both hard pack and loose trail



- Extra deep treads
- Self-cleaning lugs



- Triple-belted sidewalls to resist puncture
- Purpose-built, long lasting tread patterns



- Flexible "grippy" tread
- Aggressive side bite



ACCESSORIES

WINDSHIELDS, REAR PANELS & DOORS

CAB COMFORT

VEHICLE PROTECTION

STORAGE

OVERLANDING/ CAMPING & RECOVERY

AUDIO & CONNECTED TECHNOLOGY

HUNT/COOLERS

LIGHTING

WHEELS & TIRES

WINCHES, PLOWES & TRACKS

# WHEEL & TIRE SETS



15"

## 50-SERIES

**A 5206**   
 WEIGHT: 15.5 LBS    LOAD RATING: 1,200 LBS    OFFSET: +55  
 MATTE BLACK: FRONT/REAR    15" x 7"    1524041

**B 5302 BEADLOCK**   
 WEIGHT: 16.5 LBS    LOAD RATING: 1,670 LBS    OFFSET: +55  
 MATTE BLACK: FRONT/REAR    15" x 7"    1524038

**C 5304 BEADLOCK**   
 WEIGHT: 16 LBS    LOAD RATING: 1,600 LBS    OFFSET: +62  
 MATTE BLACK: FRONT/REAR    15" x 7"    1525420

**D 5306**   
 WEIGHT: 15 LBS    LOAD RATING: 1,740 LBS    OFFSET: +62  
 MATTE BLACK: FRONT/REAR    15" x 7"    1525684

**E 5307**   
 WEIGHT: 16 LBS    LOAD RATING: 1,740 LBS    OFFSET: +62  
 MATTE BLACK: FRONT/REAR    15" x 7"    1525686

**F 5307 BEADLOCK**   
 WEIGHT: 18 LBS    LOAD RATING: 1,740 LBS    OFFSET: +62  
 MATTE BLACK: FRONT/REAR    15" x 7"    1525688

WHEELS WITH 5 LUG NUTS

15"

### 50-SERIES

	BACKCOUNTRY/TRAIL	MUD	UTILITY	DESERT/ROCK					
	ATTACK 2.0 30"	NEW TREKKER 30"	MUD XC 30"	HARVESTER 30"	CRAWLER XR 30"	CRAWLER XP 30"	CRAWLER XG 30"	CRAWLER AT 30"	PRO RUNNER 30"
5206 MATTE BLACK	2889938	2890920	2890842	2889940	2890847	2889947	2889939	2889941	2890845
5302 BEADLOCK MATTE BLACK	2889934	2890921	2890841	2889936	2890846	2889946	2889935	2889937	2890844
5304 BEADLOCK MATTE BLACK	2889994	2891006	2890674	2889996	2890673	2890672	2889995	2889999	2890843
NEW 5306 MATTE BLACK	2890932	2890917	2890948	2890949	2890943	2890946	2890938	2890941	2890935
NEW 5307 MATTE BLACK	2890951	2890918	2890967	2890968	2890962	2890965	2890957	2890960	2890954
NEW 5307 BEADLOCK MATTE BLACK	2890970	2890919	289098	2890987	2890981	2890984	2890976	2890979	2890973

## 2 WAYS TO PURCHASE

INDIVIDUAL WHEELS & TIRES  
 - OR -  
 COMPLETE SETS AS LISTED

TO BUILD YOUR CUSTOM SET & VERIFY FITMENT, VISIT  
**POLARIS.COM/ProArmorXPEDITION**

Exclusively at Polaris Authorized Dealers or the above website



### PREMIUM TIRE SEALANT

- » 30 OZ. • 2830484
- » 1 GALLON • 2830485
- » 5 GALLONS • 2830486
- » 5 GALLONS PUMP • 2830487

See P. 66 for more information

## KNOW YOUR WHEELS

EX: **5302 BEADLOCK**

**STEP 1:**  
SELECT YOUR SERIES

**5** = 50-SERIES

**STEP 2:**  
CHOOSE YOUR LOAD RATING

- 1** = <800 LBS
- 2** = 801 - 1,300 LBS
- 3** = 1,301 - 1,600+ LBS

**STEP 3:**  
PICK YOUR STYLE

OFFSET / BEADLOCK / COLOR  
 INCREASE OFFSET FROM STOCK = NARROWER STANCE  
 DECREASE OFFSET FROM STOCK = WIDER STANCE



# WINCHES, PLOWS & TRACKS

- ✓ TESTED 1,200+ PULLS AT MAX LOAD
- ✓ OPERATES FULLY SUBMERGED
- ✓ BUILT TO WITHSTAND -20° F TEMPERATURES
- ✓ MILITARY TESTED & APPROVED



## FEATURES & BENEFITS

**PRO** PRO HEAVY DUTY SERIES

ALL POLARIS ENGINEERED WINCHES COME WITH:



- ✓ INTEGRATED WIRING, MOUNT, PREASSEMBLED
- ✓ HOOK WITH STRAP
- ✓ CUT STEEL GEARS & SEALED DRIVETRAIN
- ✓ SEALED PERMANENT MAGNET MOTOR



Retrieve cable 5x as fast as standard mode on other Polaris winches. Get back to riding or complete your task quicker.

1. Set winch dial to N (Neutral) to manually pull the rope out and secure the hook to your anchor point
2. Set winch dial to L (Low) for maximum pulling power while winching your load
3. Set winch dial to H (High) for retrieving the rope 5x faster with Rapid Rope Recovery

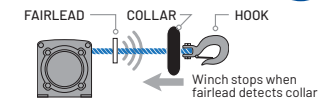

Auto Stop technology protects and extends the life of your winch by automatically stopping the winch at the end of pull to prevent over-spooling. While plowing, it prevents the plow frame from bending by stopping the winch once the plow has been lifted.



With its lightweight, yet extremely strong, design and superior flexibility, this 50 FT long synthetic rope is easy to handle and can stand up to any tough job.



This convenient remote operates your Polaris winch wirelessly from within 50 FT of the vehicle. Operate your winch safely outside your vehicle while on the job site or trails.

MODEL	HIGH-MOUNTED 6,000 LB	4,500 LB
POLARIS XPEDITION XP/5 '24	<b>2884839</b>	<b>2884838</b>
POLARIS XPEDITION ADV/5 '24	Requires HD Front Bumper (2884494-458), sold separately	<b>2884838</b>

## UPGRADES & REPLACEMENTS

**50 FT SYNTHETIC ROPE**

- » 2879188 6,000 LB SERIES
- » 2879187 4,500 LB SERIES

**WIRELESS REMOTE**

- Up to 50 FT range with LED indicator
- Direct plug & play operation
- » 2889561

**AUTO STOP UPGRADE**

- Billet aluminum
- Replaces stock fairlead
- » 2890454

Synthetic Rope & Wireless Remote (2889561) required, sold separately

## PLOW SYSTEMS

Choose a Glacier Plow System, designed to help you get the most out of your Polaris XPEDITION during snowy months. Select a system based on your plowing needs with premium add-ons including a hydraulic lift system or additional plow accessories. Additionally, plow mode is enabled in all vehicles equipped with RIDE COMMAND, which automatically raises and lowers the plow when shifting between gears.

### GLACIER PRO HD PLOW SYSTEM WITH HYDRAULICS

- System includes:
- Mount (2889578)
  - Frame (2889579)
  - Hydraulic Angle System (2889029)
  - Plow Control Handle (2889721)
  - 72" Steel Blade (2879874)
  - Plow Markers (2890649)
  - 6" Blade Extensions (2889328)

» 3880057  
POLARIS XPEDITION XP/5 '24  
POLARIS XPEDITION ADV/5 '24

### GLACIER PRO HD PLOW SYSTEM

- System includes:
- Mount (2889578)
  - Frame (2889579)
  - 72" Poly Blade (2879317)
  - Plow Markers (2890649)

» 3880058  
POLARIS XPEDITION XP/5 '24  
POLARIS XPEDITION ADV/5 '24

### GLACIER HD PLOW SYSTEM

- System includes:
- Mount (2889578)
  - Frame (2889580)
  - 72" Steel Blade (2880270)

» 3880059  
POLARIS XPEDITION XP/5 '24  
POLARIS XPEDITION ADV/5 '24



BUILD YOUR PLOW SYSTEM	STEP 1 SELECT A MOUNT	STEP 2 SELECT A FRAME	STEP 3 SELECT A LIFT METHOD	STEP 4 SELECT A BLADE	STEP 5 SELECT ACCESSORIES
POLARIS XPEDITION XP/5 '24  POLARIS XPEDITION ADV/5 '24	2889578	Pro HD Push Frame 2889579  TO INSTALL TRACKS: Track Extension 2890650 Plow Extension 2879871	Stock Winch from Factory Polaris Pro HD 4,500 LB Winch 2884838 Polaris Pro HD 6,000 LB Winch 2884839 Hydraulic Angle System* 2889029 Plow Control Handle 2889721	72" Steel Blade 2879874  72" Poly Blade 2879317	72" Blade Snow Deflector 2858541 72" HD Wear Bar 2879875 72" Replacement Wear Bar 2204829 Replacement T Shear Pin 2204829 Heavy Duty Deflector 2884160 6" Blade Extensions* 2889328 Plow Markers 2890649 <small>*Not compatible with tracks</small>



BUILD YOUR PLOW SYSTEM	STEP 1 SELECT A MOUNT	STEP 2 SELECT A FRAME	STEP 3 SELECT A LIFT METHOD	STEP 4 SELECT A BLADE	STEP 5 SELECT ACCESSORIES
POLARIS XPEDITION XP/5 '24  POLARIS XPEDITION ADV/5 '24	2889578	HD Push Frame 2889580 <small>Not compatible with tracks</small>	Stock Winch from Factory Polaris HD 4,500 LB Winch 2884838 Polaris Pro HD 6,000 LB Winch 2884839	72" Steel Blade 2880270	72" Blade Snow Deflector 2858541 72" HD Wear Bar 2879875 Replacement Shear Pin 2205527 Heavy Duty Deflector 2884160 Plow Markers 2890649

## POLARIS PLOW MODE

ENABLED IN ALL VEHICLES WITH RIDE COMMAND

Plow automatically lowers when shifting into low | Plow automatically raises when shifted into reverse | Back drag mode for pulling snow away from buildings



## PROSPECTOR PRO 2.0 TRACK SYSTEM

- Minimize track slip to provide better climbing ability and improved traction in deep snow
- Installs in place of tires and recommended for optimal traction in snowy conditions

» TRACKS\* • 2890016  
POLARIS XPEDITION XP/5 '24  
POLARIS XPEDITION ADV/5 '24

» MOUNTS + HIGH RISE INTAKES\* • 2890014  
POLARIS XPEDITION XP/5 '24  
POLARIS XPEDITION ADV/5 '24

CHOOSE A PLOW SYSTEM

BUILD A PLOW SYSTEM

ACCESSORIES

WINDSHIELDS, REAR PANELS & DOORS

CAB COMFORT

VEHICLE PROTECTION

STORAGE

OVERLANDING/CAMPING & RECOVERY

AUDIO & CONNECTED TECHNOLOGY

HUNT/COOLERS

LIGHTING

WHEELS & TIRES

WINCHES, PLOWS & TRACKS



# FOR THE LIFE OF YOUR RIDE

**PARTS THAT PUSH THE LIMITS WITHOUT SACRIFICING STRENGTH & DURABILITY.**

We build our products so anyone with the right tools can maintain their vehicle.



## MAINTENANCE TIP

### BREAK-IN PERIOD

The break-in period for your new Polaris XPEDITION is the first 25 hours of operation, or the time it takes to use the first two tanks of fuel. No single action on your part is as important as a proper break-in period. Careful treatment of a new engine will result in more efficient performance and longer life for the engine.

SEE OUR LATEST MAINTENANCE TIPS AT [XPEDITION.POLARIS.COM/EN-US/SELF-HELP](http://XPEDITION.POLARIS.COM/EN-US/SELF-HELP)

## AIR FILTER

A clogged air filter can restrict air flow to the engine leading to reduced engine performance, engine life or catastrophic failure.

7083049

## BRAKE PADS

Maintaining and/or replacing brakes are critical to the safety and functionality of a vehicle. Brake pads should be checked for wear and oil or grease (petroleum products) contamination and brake discs should be checked for cracks, excessive corrosion or warping.

Front: 2211845  
Rear: 2211852

## HALF SHAFT

Check for tears and punctures in the boot, which can lead to CV joint wear that can contribute to axle failure.

Front Kit: 2211710  
Rear Kit: 2211711

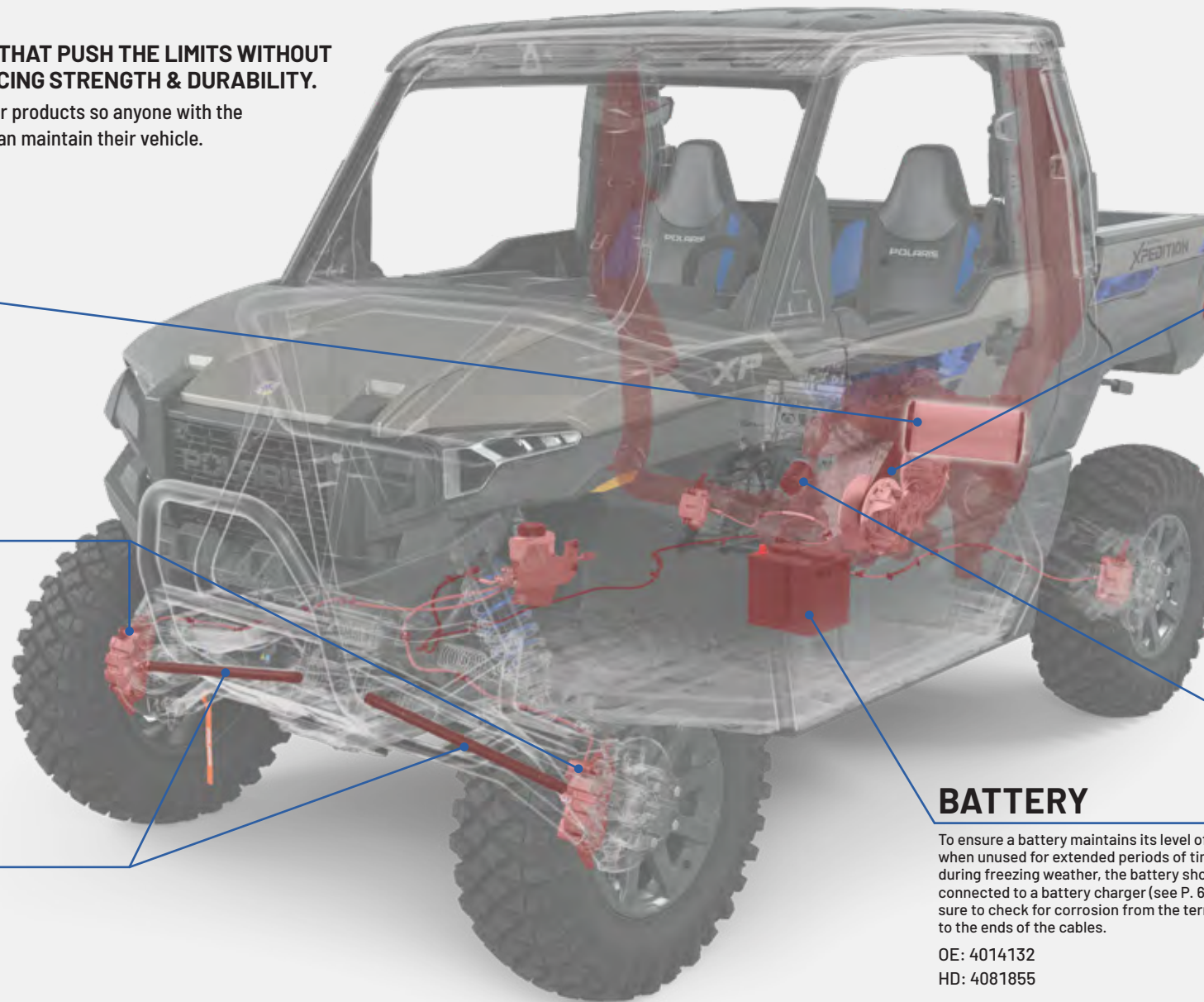

## DRIVE BELT 3211186

Polaris Engineered belts deliver unmatched performance for your off-road vehicle. Developed and tested on all our engines for all environments and conditions. Check your belt for delamination, hour glassing and glazing.

### BREAK-IN PERIOD

- Use lower gear (if available) while varying speeds and avoid wide open throttle for 5-10 miles / 8-16 km
- If no low gear is available, vary at moderate speeds while avoiding wide open throttle for 50 miles / 80 km

### OUR INVESTMENT

- 40,000+ miles / 64,000+ km of field testing
- Thousands of dyno hours
- 18+ months of development (13,000+ design hours) per belt
- 1,500+ vehicle validation hours
- Collaboration with powertrain and clutch engineers

### YOUR ADVANTAGE

- No clutch recalibration
- Less wear and tear due to heat
- Ensure maximum vehicle performance
- More time riding, less time wrenching
- Produced in collaboration with powertrain and clutch engineers to ensure a perfect fit, maximum performance and ultimate durability

## BATTERY

To ensure a battery maintains its level of charge when unused for extended periods of time or during freezing weather, the battery should be connected to a battery charger (see P. 65). Be sure to check for corrosion from the terminals to the ends of the cables.

OE: 4014132  
HD: 4081855

## OIL FILTER

Change oil filters with every oil change to provide the best engine protection and keep the engine operating at peak performance.

OE: 2540086  
HD: 2522485

**FOLLOW RECOMMENDED SERVICE INTERVALS IN THE OWNER'S MANUAL**

# MAINTENANCE SCHEDULE

## BREAK-IN MAINTENANCE

FIRST 25 HRS / 1 MONTH | 500 MI / 800 KM

- ENGINE OIL & OIL FILTER CHANGE**
- TRANSMISSION & GEARCASE REPLACE FLUIDS**
- CLUTCHES INSPECT & CLEAN REPLACE AS NEEDED**
- DRIVE BELT INSPECT & CLEAN REPLACE AS NEEDED**

## 12 MONTHS

EVERY 50 HRS / YEARLY | 1,000 MI / 1,600 KM

- ENGINE OIL & OIL FILTER CHANGE**
- DRIVE BELT INSPECT & CLEAN REPLACE AS NEEDED**
- CLUTCHES INSPECT & CLEAN REPLACE AS NEEDED**
- AIR FILTER INSPECT REPLACE AS NEEDED**
- GENERAL LUBRICATION ALL FITTINGS, PIVOTS, CABLES, ETC**

- BATTERY TEST & CLEAN REPLACE AS NEEDED**
- SPARK PLUGS INSPECT REPLACE AS NEEDED**

- BRAKE PADS & FLUID REPLACE BRAKE FLUID & PADS**
- TRANSMISSION & GEARCASE REPLACE FLUIDS**
- EXHAUST & FUEL SYSTEM INSPECT CLEAN & REPLACE AS NEEDED**

- WIRING HARNESS INSPECT CLEAN AS NEEDED**
- WHEEL BEARINGS INSPECT REPLACE AS NEEDED**
- THROTTLE BODY, INTAKE DUCTS & FLANGES INSPECT**
- STEERING COMPONENTS INSPECT REPLACE AS NEEDED**
- TIRES INSPECT ADJUST PRESSURE AS NEEDED**

## 24 MONTHS

100 HRS | 2,000 MI / 3,200 KM

- BRAKE PADS & FLUID REPLACE BRAKE FLUID**
- SHOCK ABSORBERS REPLACE OIL & SEALS**

## 30 MONTHS

150 HRS | 3,000 MI / 4,800 KM

- SPARK ARRESTOR INSPECT & CLEAN REPLACE AS NEEDED**
- TRANSMISSION & GEARCASE REPLACE FLUIDS REPLACE EVERY 2,000 MI / 3,200 KM GOING FORWARD**

## 60 MONTHS

- COOLANT CHANGE**
- VALVE CLEARANCE INSPECT ADJUST AS NEEDED**

FOR A COMPLETE MAINTENANCE SCHEDULE, CHECK YOUR OWNER'S MANUAL







## PS-4 FORMULATIONS BEST PROTECTION, BEST PERFORMANCE

Our PS-4 5W-50 formulation and PS-4 Extreme Synthetic 0W-50 have been designed to provide the best fluid technologies for long lasting wear protection. These formulations include a Polaris exclusive additive system to keep the engine cleaner from deposit build-up to maximize power and powersports-grade synthetic base stocks that provide the ultimate in engine protection.

### PS-4 5W-50 FULL-SYNTHETIC OIL

Optimal for ambient operating temperatures of -40° F to 100° F.

1 Quart	1 Gallon	16 Gallons	55 Gallon Drum	330 Gallon Tote
2876244	2876245	2876247	2876246	2878814

### PS-4 0W-50 EXTREME FULL-SYNTHETIC OIL

Optimal for ambient operating temperatures of -45° F to 130° F.

1 Quart	1 Gallon	16 Gallons	55 Gallon Drum	330 Gallon Tote
2889395	2889396	2889397	2889398	2889399



Our PS-4 Extreme Synthetic 0W-50 formulation applies only to the absolute highest performance products we sell, for ultimate protection and performance in the most extreme conditions.



### OIL CHANGE KITS

These convenient kits include everything needed including filter and oil volume per vehicle

PS-4 5W-50		PS-4 EXTREME 0W-50
PART NUMBER	VEHICLE FITMENT	PART NUMBER
2202166	RANGER/RZR/SPORTSMAN 570, TWIN 600, TWIN 700, TWIN 800	2890056
2879323	RANGER, POLARIS GENERAL 900-1000, RZR 900-1000, RS1, POLARIS XPEDITION	2890057
2877473	RANGER/SPORTSMAN 300-500, SPORTSMAN/SCRAMBLER500/850/1000	2890055
2881696	RZR TURBO (NON PRO R)	2890058

### POLARIS INVESTS IN EACH OIL AT & ABOVE THESE LEVELS

12+ DEDICATED TEAM MEMBERS FOCUSED ON POLARIS OIL	18+ MONTHS DEVELOPMENT & TESTING	76,000+ HOURS DYNO TESTING	2.2/3.5 MILLION+ MILES/KM FIELD TESTING
--	----------------------------------	----------------------------	---

### ENGINE WEAR TEST

LOWER NUMBER = LESS WEAR OF CRITICAL ENGINE PARTS  
LESS WEAR MEANS LONGER ENGINE LIFE

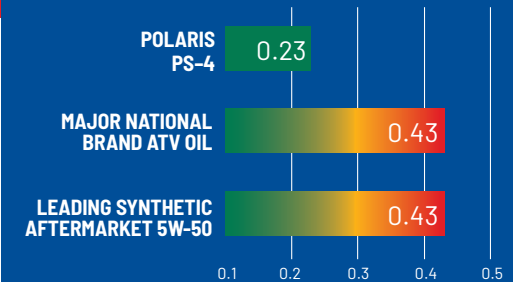

ASTM D4172. In 3rd party against 11 competitive products Polaris had 40% or better wear protection compared to all of the test products.

### THE BEST PROTECTION

- At least 40% improved wear protection compared to previous Polaris PS-4 formulation and all aftermarket oils tested
- Best engine protection against wear for the longest engine life.

### DEPOSIT TEST

LOWER DEPOSITS = MAXIMUM POWER

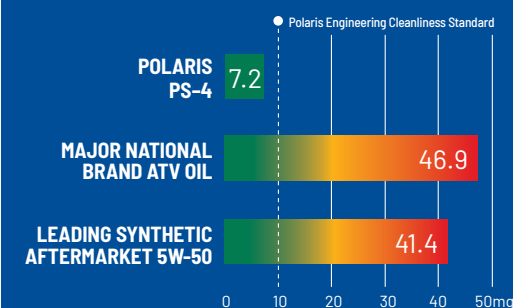

ASTM D6335. In 3rd party against 9 competitive products Polaris PS-4 had less than half the deposits compared to the next closest product. No other tested products met Polaris Engineering standards for deposit cleanliness.

### MAXIMUM PERFORMANCE

- Improved PS-4 formulation provides 33% less deposits than previous PS-4 formula
- At least 50% less deposits than all aftermarket oils tested
- The cleanest engine for maximum power and performance!





# MAINTENANCE FLUIDS



## ENGINE OIL

Maximum protection for your 4-cycle engine.

» SEE P. 60



## AGL

Protect gears, drive chain and bearings from scoring and wear.

- » 1 QT • 2878068
- » 1 GALLON • 2878069
- » 2.5 GALLONS • 2878070
- » 55 GALLONS • 2879594

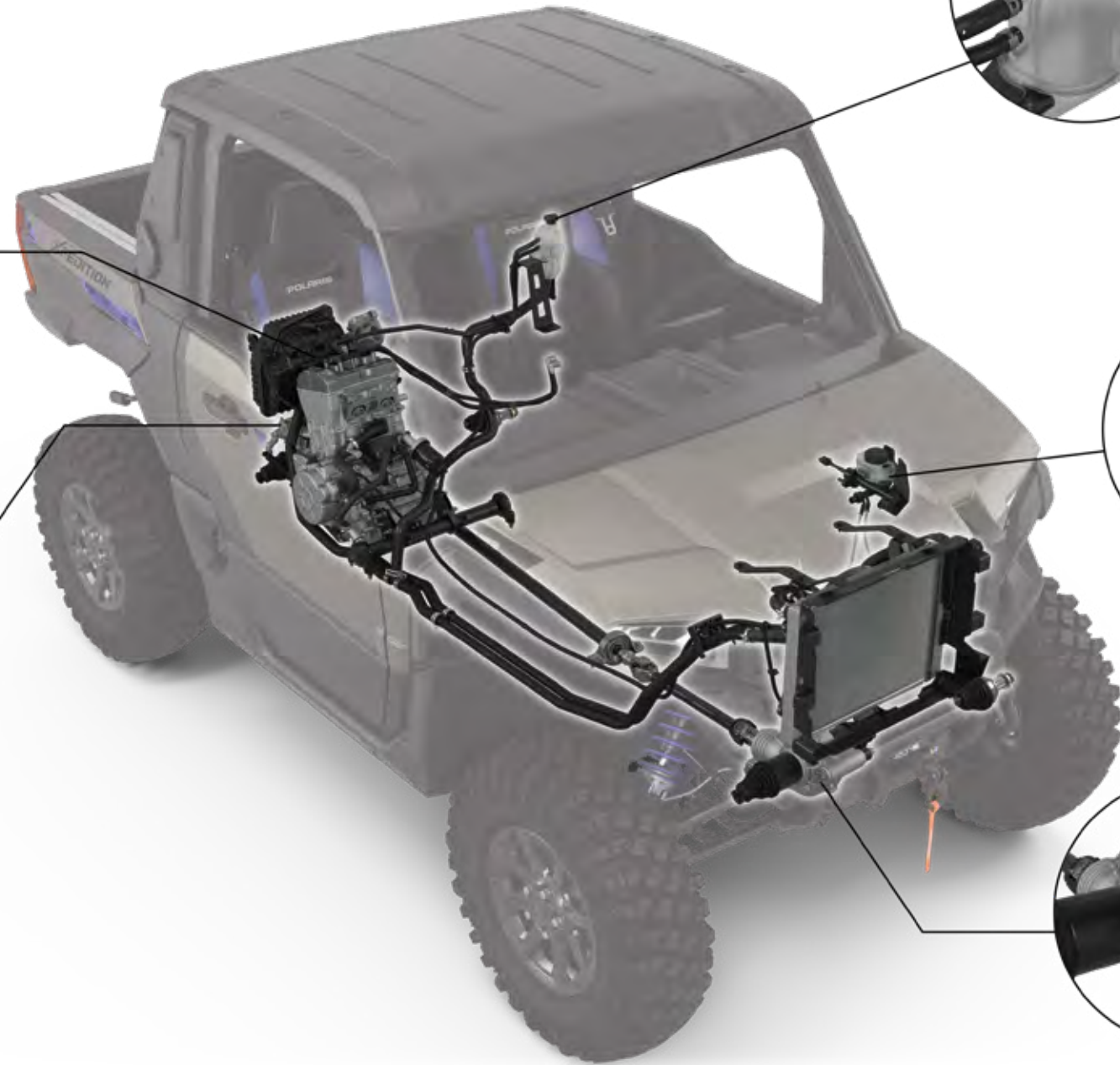
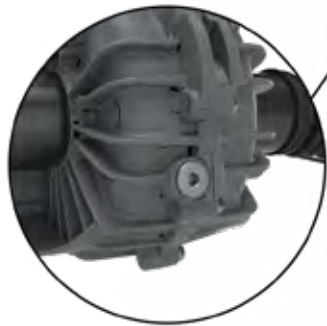

## ANTI-FREEZE

Prevent corrosion on metal components, eliminate scaling and maximize cooling system performance.

- » 1 QT • 2880514
- » 1 GALLON • 2880513
- » 55 GALLONS • 2880512



## DOT 4 BRAKE FLUID

A high-quality brake fluid designed for use in Polaris hydraulic brakes.

- » 12 OZ • 2872189



## DEMAND DRIVE FLUID

Provide positive 4WD engagement in extreme cold or high heat conditions and protect internal components under heavy loads.

- » 1 QT • 2877922
- » 2.5 GALLONS • 2877923



## PREMIUM GAS SHOCK OIL

- » 1 QT • 2874124  
WALKER EVANS RACING® REBUILDABLE SHOCKS
- » 1 QT PREMIUM • 2870995
- » 2.5 GALLONS PREMIUM • 2872279  
FOX® REBUILDABLE SHOCKS



## SUSPENSION/ U-JOINT GREASE

- » 3 OZ • 2871515
- » 14 OZ • 2871551



## ALL-SEASON GREASE TUBE

- Specialized water-resistant lubricant
- » 3 OZ • 2871322
- » 14 OZ • 2871423



## CARBON CLEAN

- Ultimate fuel and injection system cleaner
- » 12 OZ • 2881413



## ADVANCED FUEL TREATMENT

- Dual antioxidant formula protects jets and fuel system from gum and varnish
- » 12 OZ • 2881416



# GARAGE ACCESSORIES



## FLUID FUNNEL

- Easily add oil with high accuracy
- » 2830552



## FUNNELS

- Unique capped design eliminates spills and contaminants
- » BLUE • 2830574  
» RED • 2830575  
» GREEN • 2830576



## HANDHELD PUMP SPRAYER

- Half gallon portable sprayer, lightweight and easy to use
- » 2830570



## GREASE GUN

- Comfort grip handle and heavy-duty follower spring for high pressure applications and easy priming
- » 14 OZ • 2830569  
FOR 14 OZ ALL-SEASON & U-JOINT



## GREASE GUN

- Enables easy application of grease
- » 3 OZ • 2871312  
FOR 3 OZ ALL-SEASON & U-JOINT



## FLEX SPOUT

- Fits all Polaris quart, gallon and 2.5 gallon bottles
- » 2871285



## PUMP

- Fits 1 and 2.5 gallon bottles
- » 2870465



## FLUID SYRINGE

- Easily add and remove fluid from your vehicle
- » 2830553



## 2D BATTERY-OPERATED SIPHON PUMP

- Liquid transfer pumps 5-6 quarts/min suctioning power
- » 2830513



## POLARIS HEAVY-DUTY SCRUBBER WIPES

- » 90 CT • 2830441



## POLARIS SHOP TOWELS

- » 200 CT WITH DISPENSER • 2830402
- » 200 CT REFILL • 2830403
- » 64 CT REFILL • 2830440



## OIL CHANGE KIT

- 6.5 QT drain pan, one pint oil funnel with screen, oil filter wrench, 15" x 18" absorbent pads (2), clean up wipe (1), 6 mil nitrile gloves (1 pair), blue interfold shop towels (4)
- » 2830545



## OIL FILTER WRENCH

- Remove Polaris ORV oil filters with ease
- » 2830550



## FLUID TRAY

- Holds up to 8 quarts of fluid
- » 2830551



## POLARIS MAGNETIC PARTS TRAY

- » 2830432



## FLEXIBLE CLUTCH COVER TOOL

- The perfect tool for hard to reach CVT cover bolts
- » 2830572



## POLARIS 33" TELESCOPIC MAGNET

- » 2830435



## POLARIS 12" HI-TORQUE RATCHETING DRIVER

- » 2830434



## POLARIS LED POCKET FLASHLIGHT

- » 2830436



## WORK LIGHT - 550 LUMENS

- UV and dual-charging on a 360° rotating swivel
- » 2830584



## PREMIUM MAINTENANCE TOOL KIT

- Includes everything you need to work on and repair Polaris vehicles
  - Lifetime warranty on select tools
- » 2830565



## WORK LIGHT - 1000 LUMENS

- Adjustable with magnetic ends
  - Battery charge indicator
- » 2830585



## WORK LIGHT - 4000 LUMENS

- 90° swivel LED light
  - 16 FT, 14 gauge extension cord cable reel
  - Magnetic backing
- » 2830586



## PORTABLE AIR COMPRESSOR

- Handheld air compressor with Li-ion battery
  - Programmable PSI pressure settings, LED light and USB phone charger
- » 060-DAP



## PORTABLE AIR COMPRESSOR CASE

- » 060-BAG

# BATTERY CHARGERS



## NOCO® BATTERY CHARGER - 1 AMP

- Ensure your battery is charged with the NOCO® Battery Charger 1 Amp
  - Includes Boost Eyelet Cable with X-Connector Adapter (2830546)
- » 2830567



## NOCO® BATTERY CHARGER - 2 AMP

- Ensure your battery is charged with the NOCO® Battery Charger 2 Amp
  - Includes Boost Eyelet Cable with X-Connector Adapter (2830546)
- » 2830568



## 1,000 AMP ULTRASAFE LITHIUM JUMP PACK

- Delivers 1,000 amps for jump starting a dead battery in seconds
- » 2830547



## JUMP PACK PROTECTION CASE

- Lightweight, durable and rugged custom exterior
- » 2830548

# HD HEAVY DUTY PARTS

All Polaris parts are developed and tested to help you get the most out of your ride. We're taking the passion of our riders, workers and outdoor enthusiasts to the next level with HD Parts.

Engineered and designed for:

- Greater durability
- Enhanced performance
- Greater wear and tear capabilities
- All weather conditions



## OIL FILTERS

The advanced synthetic material built into these filters offers the highest debris holding capacity, maintains oil flow and maximizes performance.

OE	HD HEAVY DUTY PARTS
2540086	2522485



## BATTERY

AGM fully sealed for optimal starting power with maximum reserve capacity, designed for highly accessorized vehicles and extreme operating conditions.

OE	HD HEAVY DUTY PARTS
4014132	4081855

# SERVICE PARTS

## LOOK-UP PARTS ON POLARIS.COM

FOR EASY PARTS IDENTIFICATION, VIEWS OF ASSEMBLIES & MORE!

Visit [Polaris.com/PolarisXPEDITION](http://Polaris.com/PolarisXPEDITION)

Click the "Parts & Accessories" tab

Enter vehicle year/model then select the part

Clearly see what parts are required and order





# TIRE SEALANT

24 X 7 COVERAGE | BE PREPARED FOR ANYTHING

## HOW IT WORKS

- 1 Tire sealant remains liquefied inside the tire until a leak develops in the tire or wheel.
- 2 Once a leak occurs, the tire sealant rushes out of the tire and quickly creates a permanent solid plug, maintaining tire pressure so you can continue your ride.



### HOW MUCH DO YOU NEED?

$$\text{TIRE HEIGHT (IN.)} \times \text{TIRE WIDTH (IN.)} / 5 = \text{OUNCES REQUIRED PER TIRE}$$

VISIT [POLARIS.COM/TIRESEALANTCHART](http://POLARIS.COM/TIRESEALANTCHART) TO LEARN MORE

## PREMIUM TIRE SEALANT

- Instantly seals and repairs rim, bead leaks and punctures up to .25" on standard tires and .75" on heavy ply tires
- Helps seal the tire bead against the wheel
- Creates permanent repair, helps maintain air pressure for the life of the tire
- 100% water soluble for easy cleanup
- Remains fluid and effective in temperatures down to -45° F
- Will not rust, corrode or pit wheels
- Easily installed through existing tire valve stem with valve core removed

» 32 OZ • 2830484  
» 1 GALLON • 2830485

» 5 GALLONS • 2830486  
» 5 GALLONS PUMP • 2830487

» 55 GALLONS • 2830489  
» 275 GALLONS • 2830488

# CV BOOT REPAIR KIT\*

FIX ON THE GO | TEMPORARY COVERAGE

- A quick trail-side fix to increase trail time
- The flexible and durable boot material expands over a cone tool for CV boot repairs, without disassembling CV axles
- Universal fit - works as a temporary fix for most powersports axles
- All components fit inside the cone, and a cover is provided for compact durable storage
- Easily fits in a cargo box, attached to the roll cage, in the glovebox or many other storage locations



Items shown are contained inside cone

## UTV CV BOOT REPAIR KIT

Kit includes the following items:

- (1) Expandable XL CV Boot
  - (1) Reusable Cone Tool
  - (2) CV Boot Clamps
  - (1) Tube of Silicone Lube
  - (1) Grease Packet
  - (1) Cone Cover
- » 2830526

## UTV TRAIL BOOT ONLY

» 2830527

## ATV

» CV REPAIR KIT 2830528  
» TRAIL BOOT ONLY 2830529

SEE HOW THE CV BOOT REPAIR KIT WORKS AT [POLARIS.COM/MAINTENANCE-VIDEOS](http://POLARIS.COM/MAINTENANCE-VIDEOS)

## HOW TO INSTALL

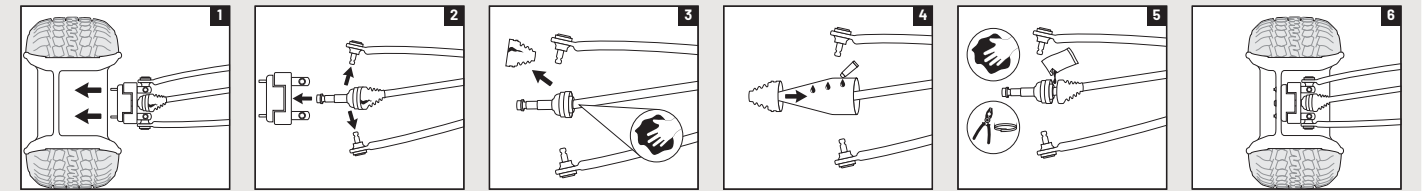

- 1 Remove wheel and axle nut.
- 2 Remove brake caliper, hub, tie rod and upper and lower ball joints.
- 3 Remove old boot and clean joint.
- 4 Spread silicone lube on entire cone tool. Slide boot over cone tool, large end first. See package for outer boot instructions.
- 5 Empty the bag of grease into the CV joint/boot, clean sealing points and install clamps.
- 6 Reassemble tie rod, ball joints, brake caliper, axle nut, tire and wheel.

Refer to your service manual for further instructions and torque specifications.  
\*Designed for temporary CV boot repair. Purchase the OEM CV Boot for a permanent repair.

# BRING IT EVERYWHERE

## TRAILERING



### CALIBER® RAMP PRO

- Designed for ATVs and UTVs up to 50" wide
  - Integrated grip glides for ultimate traction
  - Folding sides for easy transportation and storing
- » 52" x 90" • 2884576



### ALUMINUM ARCHED LOADING RAMPS

- Capacity for up to 3,000 LBS, 1,500 LBS per ramp
- » 76" x 12" • 2,000 LB • 2875384  
» 88" x 12" • 3,000 LB • 2875386

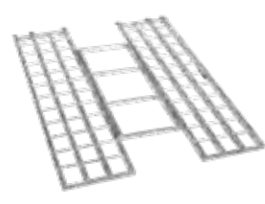

### LIGHTWEIGHT TRI-FOLD RAMPS

- Ramp folds up for transport
  - Capacity for up to 1,500 LBS
  - Safety straps included
- » 72" x 51" • 2875385  
» 82" x 51" • 2875860

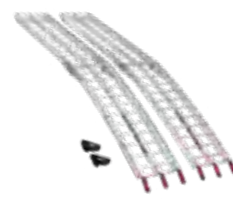

### FOLDING ALUMINUM ARCHED RAMPS

- Ramp folds up for transport
  - Up to 1,500 LB total capacity, 750 LBS per individual ramp
  - Safety straps included
- » 88" x 12" • 2875387

## COVERS

### TRAILERABLE COVER

» 2-SEAT • 2889723  
POLARIS XPEDITION XP '24  
» 5-SEAT • 2889724  
POLARIS XPEDITION XP 5 '24

» 2-SEAT • 2889725  
POLARIS XPEDITION ADV '24  
» 5-SEAT • 2889726  
POLARIS XPEDITION ADV 5 '24



## HITCHES



### HITCH WITH 2" BALL

- 3:1 Hitch: ball, hook and pin design
  - Rust resistant steel with powdercoat finish
  - Removable ball, HD 5/8" pin and clip
- » 2" x 2" RECEIVER • 2830522  
» 1 1/4" x 1 1/4" RECEIVER • 2830523



### 1 7/8" BALL

- Replacement ball for hitch
  - Works with 3:1 Hitch
- » 2830524



### RECEIVER HITCH

- » 2" RECEIVER TONGUE 2875320



### TRAILER BALL 3/4" SHANK

- » 1 7/8" BALL • 2877602
- » 2" BALL • 2877603

## STRAPS & ROPES



### RECOVERY STRAP

- 2" x 30'
  - 18,000 LB maximum load, 9,000 LB maximum vehicle weight
  - Comes with carry bag
- » 2884033



### RATCHET STRAP

- 1.5" x 15' straps, 2 pack
  - Heavy duty webbing
  - 5,500 LB maximum load, 1,833 LB working load
- » 2884031



### RATCHET STRAP

- 2" x 20' Ratchet Straps
  - Heavy duty webbing, floating D-rings, double J-hooks
  - 10,000 LB maximum load, 3,300 LB working load
- » 2884032



### SHOCK STRAPS

- 1.5", 3,000 LB breaking strength
  - Keeps tension on tie-down straps to secure load, 2 pack
- » 1.5" x 15' • 2883296  
» 1.5" x 7' • 2883295



# POLARIS POWER

FOR THE WORKERS, PLAYERS AND SAVE-THE-DAYERS.

BACKED BY A



WARRANTY



VISIT [POLARISPOWER.COM](http://POLARISPOWER.COM) FOR ALL PRODUCT FEATURES

## THE POWER TO EMPOWER

At Polaris Power, we are committed to powering more. We proudly donate 3% of our profits by providing portable power to areas affected by natural disasters and the organizations providing relief in North America.



### P2000i

Inverter Generator 2830532

1600

Running Watts

2000

Starting Watts

16.7

Max Amps at 120V

7.6

Run Time at 25% Load w/ Smart Throttle (hrs)

62

Noise Level at 25% Load (dBA)

#### FEATURES



Extension Cord Management

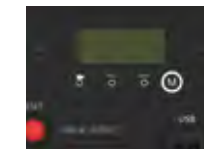

Multi-Functional Digital Display

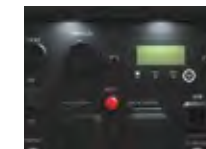

Illuminated Control Panel

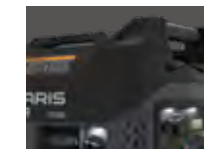

Multi-Handle Design



Parallel Capable

#### BEST USED FOR



Tailgating



Off-Grid



Camping



#### FEATURED ACCESSORIES



ALL WEATHER COVER

» 2830542



HIGH ALTITUDE MODIFICATION KIT

» P2000i • 2884865



SMALL ENGINE OIL

• 4-cycle engine oil  
» 1QT • 2879383



INVERTER PARALLEL KIT

» 2830536

Read, understand and follow your owner's manual. Never operate a generator indoors. Generator exhaust contains carbon monoxide vapors and exposure can result in severe injury or death. Gasoline is highly flammable and explosive under certain conditions. Always use extreme care whenever handling gasoline.

PARTS & GARAGE

MAINTENANCE

OIL & LUBRICANTS

MAINTENANCE FLUIDS

GARAGE ACCESSORIES & BATTERY CHARGERS

HD PARTS & SERVICE PARTS

TIRE SEALANT & TRAILERING

POLARIS POWER





VISIT POLARISPOWER.COM FOR ALL PRODUCT FEATURES

## P2500iEBT\*

Inverter Generator **2830537**

**2000**

Running Watts

**2500**

Starting Watts

**17**

Max Amps at 120V

**8**

Run Time at 25% Load w/ Smart Throttle (hrs)

**65**

Noise Level at 25% Load (dBA)

### FEATURES



Polaris Mobile App Compatible



Digital Fuel Gauge



Carbon Monoxide Detection & Auto Shut Off



Electric Start with Electric Choke



Parallel Capable

### BEST USED FOR



Camping



Tailgating



Off-Grid



## FEATURED ACCESSORIES



### ALL WEATHER COVER

» 2830542



### HIGH ALTITUDE MODIFICATION KIT

» P2500iEBT • 2889540  
» P3200iE • 2884866



### SMALL ENGINE OIL

• 4-cycle engine oil  
» 1QT • 2879383

## P3200iE

Inverter Generator **2830533**

**2800**

Running Watts

**3200**

Starting Watts

**23.3**

Max Amps at 120V

**10.1**

Run Time at 25% Load w/ Smart Throttle (hrs)

**67**

Noise Level at 25% Load (dBA)

### FEATURES



Key Fob Remote Start



Multi-Functional Digital Display



Fuel Gauge

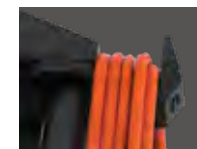

Extension Cord Management



Parallel Capable

### BEST USED FOR



Camping



One Room Backup



DIY Remodeling



### INVERTER PARALLEL KIT

» 2830536



### FLUID FUNNEL

» 2830552



### FLUID SYRINGE

» 2830553



### 2D BATTERY-OPERATED SIPHON PUMP

» 2830513



### FLUID TRAY

» 2830551

Read, understand and follow your owner's manual. Never operate a generator indoors. Generator exhaust contains carbon monoxide vapors and exposure can result in severe injury or death. Gasoline is highly flammable and explosive under certain conditions. Always use extreme care whenever handling gasoline.





## P5500 / P6500

2830534 / 2830535

Open Frame Generator

**5000 / 6000**

Running Watts  
(P5500 / P6500)

**5500 / 6500**

Starting Watts  
(P5500 / P6500)

**20/30**

Max Amps  
at 120/240V

**5**

Run Time  
(hrs)

**75**

Noise Level  
(dBA)

### FEATURES



Extension Cord Management



Fuel Gauge



Electric Start

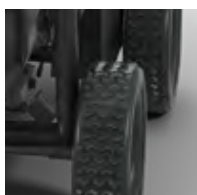

Rough Terrain Wheel

### BEST USED FOR



Construction



Home Backup



RVing



## FEATURED ACCESSORIES



### ALL WEATHER COVER

» 2830542



### HIGH ALTITUDE MODIFICATION KIT

» P5500/P6500 • 2884867



### SMALL ENGINE OIL

• 4-cycle engine oil  
» 1 QT • 2879383



## PRESSURE WASHER 3700

- 3700 PSI at 2.5 GPM
- Simpson Pro-Axial Cam Pump
- CRX 4-stroke 225cc OHV engine
- Low-oil shut-down system
- 10" pneumatic tires
- Heavy-duty steel engine plate
- 1.25" tubular construction
- Professional spray gun
- 35' Morflex® hose

2830573

## PRESSURE WASHER ACCESSORIES



### 50 FT EXTENSION HOSE

- Designed to be highly flexible and kink resistant
  - This cold water hose is equipped with standard M22 threaded connections, a dual o-ring and polyurethane outer jacket that is non-marring and abrasion-resistant for improved durability
- » 2830577



### TURBO NOZZLE

- 3700 PSI .25" QC turbo nozzle delivers a strong jet of oscillating water that cleans faster than standard nozzles
  - Made for reliability and durability, this nozzle is easy to use and great at cleaning hard to remove dirt and debris
- » 2830579





# APPAREL

**FIT FOR ANY ADVENTURE.** For outdoor enthusiasts looking for gear that's purposefully built to stand up to the fun and challenging experiences Polaris vehicles enable. Each piece of apparel and equipment bearing the name Polaris is crafted by outdoor enthusiasts, for outdoor enthusiasts. They are a badge of honor – representing what the Polaris brand stands for – a passion to simply be outside doing what you love.



**KEEP CHASING TEE**

Men's | Dark Gray Heather | S-3XL | 2864751  
 Men's | Olive Heather | S-3XL | 2864752  
 Women's | Dark Gray Heather | S-3XL | 2864753

**POLARIS XPEDITION ADVENTURE TEE**

Men's | Heather Gray | S-3XL | 2864756  
 Women's | Heather Gray | S-3XL | 2864757



# JERSEYS & GLOVES



## OFF-ROAD RIDING JERSEYS

Mesh ventilated panels for maximum airflow  
Elastic sleeves with non-restrictive cuffs



### BLACK

JERSEY | S-3XL | 2862718  
GLOVES | S-3XL | 2862726  
YOUTH JERSEY | S-XL | 2862723

### ORANGE

JERSEY | S-3XL | 2862719  
GLOVES | S-3XL | 2862729

### TEAL

JERSEY | S-3XL | 2862720  
GLOVES | S-3XL | 2862727  
YOUTH JERSEY | S-XL | 2862724

### BLUE

JERSEY | S-3XL | 2862722  
GLOVES | S-3XL | 2862728  
YOUTH JERSEY | S-XL | 2862725

## OFF-ROAD RIDING GLOVES

Adjustable wrist closure for a custom fit  
Silicon finger grips and neoprene knuckle protection



## TEKVEST® FREESTYLE

Black | S-3XL | 2862577



## NECK GAITERS

Keep the sun off your neck and the dust off your face. Stretchy and seamless material that is UPF 15-18 for sun protection and moisture-wicking.

Blue | 2833138  
Camo | 2861948  
Black | 2861953  
Red Retro | 2861950  
Lime | 2861952

# HEATED APPAREL

Keep warm even on the coldest days with Polaris Heated Apparel. By keeping the heat close to your body, you can stay out for a longer, more comfortable ride. The Polaris Heated Apparel lineup includes the Heated Vest, Heated Base Layers and a Heated Glove Liner for both men and women. Easily control your heat setting with the touch of a button.



**WOMEN'S**  
Black | 2833036



**MEN'S**  
Black | 2833022

HEATING ELEMENTS



**UNISEX**  
Black | 2833044

## HEATED VESTS

WARMTH WITH THE TOUCH OF A BUTTON

S-3XL

- Perfect for any outdoor activity
- Down-proof machine washable material with 160g of insulation for warmth with or without the heater turned on
- Powered by a small rechargeable battery (included) that can also be used to charge a cellphone; battery not machine washable, remove prior to washing
- Easily adjust between four heat settings for changing weather conditions with built-in buttons



**WOMEN'S**  
Top | 2833033  
Bottom | 2833034



**MEN'S**  
Top | 2833031  
Bottom | 2833032

## HEATED GLOVE LINER

KEEP YOUR HANDS WARM ON FROSTY DAYS

S-3XL

- Designed to fit under all Polaris riding gloves for an extra layer of warmth to keep you out riding longer
- Easily adjust your heat level by pressing a button on the bottom part of the glove

## HEATED BASE LAYERS

ADJUSTABLE HEAT CLOSE TO YOUR BODY, MAXIMUM COMFORT IN CHANGING CONDITIONS

S-3XL

- Intended for use as a base layer
- Features lightweight, moisture-wicking fabric to give you the most comfortable layering to wear on all of your cold weather adventures, on or off the trail
- Includes multiple heat panels for evenly distributed heat for maximum warmth and comfort
- Powered by a small rechargeable battery (included) that can be used to charge a cellphone; battery not machine washable, remove prior to washing
- Easily adjust between four heat settings for changing weather conditions with built-in buttons

## HEATED APPAREL REPLACEMENT BATTERY PACK

- Compatible with Polaris Heated Base Layer Tops, Bottoms & Vests
- Includes: 7.4V Lithium-Ion Battery with two 7.8V chargers (110V wall and 12V port)

2864582



## HEATED GLOVE LINER REPLACEMENT BATTERY PACK

- Compatible with Polaris Heated Glove Liners
- Includes: two 7.4V Lithium-Ion Batteries, one 100-240V charger

2864583





# HELMETS



CARBON FIBER WHITE  
2864538



RETRO  
2864541



ORANGE/TAN  
2864559



## 509 ALTITUDE 2.0

LIGHTWEIGHT DESIGN, PERFORMANCE-INFUSED STYLE & GOPRO® MOUNTING CAPABILITY

XS-4XL

### SHELL

- Thermoplastic poly alloy outer shell

### WEIGHT

- Composite as low as 1,200g, Carbon fiber as low as 1,150g

### FEATURES

- Strong, lightweight construction of carbon fiber or composite
- Superior fit for all-day comfort
- Pro Series breath box for complete protection, removable for optimal air flow
- One-piece eyepoint creates draft-free seal with 509 goggles
- Magnetic Fidlock® chin-strap technology and integrated GOPRO® mount
- DOT- and ECE 22.05-approved



RED  
2833054



RADIANT GREEN  
2833051



ZENITH BLUE  
2864542



MATTE BLACK  
2862468



BLACK  
2861469



CARBON FIBER BLACK/LIME  
2861473



PINK  
2833050



ORANGE  
2862471



## TACTICAL 2.0

COMBINES STYLE WITH VERSATILITY FOR ULTIMATE COMFORT & CONTROL

XS-4XL

### SHELL

- Shock-resistant, injection-molded thermoplastic

### WEIGHT

- 1,300g

### FEATURES

- Innovative Venturi Vent pulls moist air from helmet without cold wind coming in
- Eyepoint seal is co-integrated with the removable breath box and creates a draft-free seal with 509 goggles and a clear field of view
- Magnetic Fidlock® chin-strap technology
- DOT- and ECE 22.05-approved

## TENACITY 4.0

COMBINATION OF MODERN STYLE & PREMIUM PROTECTION WITH INCREDIBLE VALUE

XS-2XL

### SHELL

- Shock-resistant, injection-molded thermoplastic

### WEIGHT

- 1,500g

### FEATURES

- Through-flow, full-helmet ventilation
- ProClip quick release chin strap allows you to fasten the chin strap in seconds
- Removable breath box and removable, washable liner
- Tool-less adjustable roost shield
- DOT- and ECE 22.06-approved



BLACK/LIME  
2864560



RADIANT GREEN  
2833142



BLACK  
2861557



BLACK/GRAY  
2861558



WHITE/RED  
2861561



BLUE  
2833143

# GOGGLES



BLUE  
2862562

## 509 KINGPIN

PREMIUM MATERIALS, ATTRACTIVE PRICE

### FEATURES

- Built for off-road, the oversized spherical lens delivers optimal peripheral vision
- Metal tear-off posts provide strength and durability
- Quick-change technology allows you to run the best lens tint for conditions



STEALTH  
2862560



ORANGE  
2862561



BLACK  
2862557

## 509 MX6

SUPER WIDE FIELD OF VIEW, ENGINEERED FOR DIRT

### FEATURES

- PC outer lens with anti-scratch coating, and internal anti-fog coating
- Outriggers with latch system for quick lens change
- 45mm strap with silicone to hold strap in place



LIME  
2862559



RED/BLACK  
2862558

APPAREL

509 APPAREL

JERSEYS, GLOVES & HEATED APPAREL

HELMETS & GOGGLES

MEN'S APPAREL

BALL CAPS & BEANIES

WOMEN'S APPAREL

HOME & COLLECTIBLES





BLUE  
2864518



GRAY/RED  
2833029



CYPRESS  
2864517



CAMO  
2861543



BLUE  
2833028



BLACK  
2861434

## FORCE PUFFER JACKET

PACKABLE JACKET OFFERS LIGHTWEIGHT PROTECTION & INCREDIBLE WARMTH

S-3XL

- 140g 3M<sup>®</sup> Thinsulate<sup>®</sup>
- Two external hand pockets, one internal media pocket
- Rugged YKK<sup>®</sup> zippers
- Compactable into travel pocket

## SOFTSHELL JACKET

VERSATILE LIGHTWEIGHT JACKET THAT'S PERFECT FOR EVERYDAY WEAR

S-3XL

- Casual jacket armed with rugged and warm features for everyday wear
- Superior DWR prevents precipitation from saturating the jacket's exterior
- Lined with soft fleece for warmth
- Removable hood and underarm venting, three external pockets and one internal chest pocket



BLACK  
2862569

## WORK VEST

RUGGED & DURABLE VEST THAT'S IDEAL AS AN OUTDOOR LAYER

S-3XL

- Made of durable nylon fabric to make it the ideal vest for work
- 80g 3M<sup>®</sup> Thinsulate<sup>®</sup> Insulation provides great warmth
- Vest comes with plenty of pockets to store your valuables



BLUE/GRAY  
2864521



RED  
2833030



BLACK/GRAY  
2862565



CAMO  
2862572

## REVOLVE VEST

DURABLE & WARM REVERSIBLE VEST OFFERS TWO STYLES IN ONE

REVERSIBLE

S-3XL

- Durable windbreak outer fabric helps protect from the elements
- 140g 3M<sup>®</sup> Thinsulate<sup>®</sup> insulation keeps you warm in cold weather



BLACK/GRAY  
2864524

RED  
2833026

BLUE/ORANGE  
2862567



BLUE  
2864525

BLACK/LIME  
2833024

TAN  
2862450

## TITAN MID-LAYER

VERSATILE MID-LAYER CAN BE WORN ALONE OR AS AN EXTRA LAYER

S-3XL

- 319g Polartec<sup>®</sup> Thermal Pro<sup>®</sup> Rib Sweater provides great warmth
- Breathable material moves sweat to the outer surface
- Nylon overlay is comfortable and light

## NORTHSTAR MID-LAYER

EXTREMELY WARM YET BREATHABLE MID-LAYER, PERFECT FOR RIDING

S-3XL

- 280g of breathable fleece for added warmth
- Offers durable protection against the elements with a wear-resistant polyester face and wind-block layer on chest
- Designed to fit under outer shell when riding



LIGHT GRAY  
2833110

GRAY  
2862521

NAVY  
2862523

## ADAPT QUARTER-ZIP

EXTRA LIGHT MID-LAYER WITH A COMFORTABLE FIT

S-3XL

- Versatile use both on and off the trail
- The polyester and spandex blend enables a flexible fit



CYPRESS  
2864523

DARK BLUE  
2864522

ORANGE  
2833025

GRAY  
2862576

BLUE  
2861443

## TECH QUARTER-ZIP

FLEECE LINED MID-LAYER FOR ESSENTIAL WARMTH WHILE RIDING WITH THE STYLE & COMFORT TO WEAR ANYWHERE

S-3XL

- Fleece-lining keeps you cozy and warm
- Move freely with four-way stretch material
- Contoured, slim fit





**UPF HOODIE TEE**

Blue | S-3XL | 2833072  
Gray | S-3XL | 2833073



**CREW SWEATSHIRT**

Green | S-3XL | 2864632  
Navy | S-3XL | 2864633  
Gray | S-3XL | 2833067  
Black | S-3XL | 2862488



**JOURNEY HOODIE**

Red | S-3XL | 2864535  
Cypress | S-3XL | 2864536  
Black | S-3XL | 2862489



**STAPLE HOODIE**

Blue | S-3XL | 2864605  
Black | S-3XL | 2833068  
Green | S-3XL | 2833070



**TECH FULL-ZIP HOODIE**

Blue | S-3XL | 2864531  
Gray | S-3XL | 2861493



**ROGUE HOODIE**

Blue | S-3XL | 2864587  
Black | S-3XL | 2833062  
Navy | S-3XL | 2833063



**PLAID FLANNEL SHIRT**

Blue | S-3XL | 2864671  
Cypress | S-3XL | 2864672



**ADVENTURE LONG SLEEVE**

Gray | S-3XL | 2833089  
Black | S-3XL | 2833090



**ICON EDGE LONG SLEEVE**

Gray | S-3XL | 2864682  
Blue | S-3XL | 2864683



**PERFORMANCE LONG SLEEVE**

Gray/White | S-3XL | 2833324  
Red | S-3XL | 2864600  
Royal Blue | S-3XL | 2833325  
Gray | S-3XL | 2833168  
Black | S-3XL | 2862507



**ICON LONG SLEEVE**

Blue | S-3XL | 2864591  
Navy | S-3XL | 2864590  
Lime | S-3XL | 2833083  
Black | S-3XL | 2861584



**GRAPHIC TEE**

Heather Gray | S-3XL | 2864612  
Dark Gray | S-3XL | 2833086  
Forest Green | S-3XL | 2833087



**FLAG TEE**

Navy | S-3XL | 2862500  
White | S-3XL | 2862582



**HALF DOME TEE**

Black | S-3XL | 2864616  
Olive | S-3XL | 2864617  
Navy | S-3XL | 2864618



**PEAK GRAPHIC TEE**

Blue | S-3XL | 2864684  
Black | S-3XL | 2864685



**ASCENT TEE**

Olive | S-3XL | 2864680  
Navy | S-3XL | 2864681



# BALL CAPS



**HALF DOME PATCH CAP**

Black | 2864576  
Tan | 2864577



**METAL BADGE PANEL CAP**

Cypress | 2864574  
Black | 2864575



**HEX PATCH COOLING CAP**

Black | 2864571  
Blue | 2864572  
Gray | 2864573

# BEANIES



**STAPLE BEANIE**

Purple | 2864693  
Radiant Green | 2833121  
Gray | 2833122  
Black | 2833116  
Navy | 2833117



**CORE BEANIE**

Red | 2864695  
Olive | 2864696  
Blue | 2833114  
Black | 2862530  
Orange | 2862595



**SWITCHBACK BEANIE**

Olive | 2864694  
Blue | 2833115  
Black | 2862532  
Gray | 2862533



**ELLIPSE PATCH TRUCKER HAT**

Purple | 2864563  
Cypress | 2864562  
Gray | 2833498  
Black | 2833500  
Navy | 2833499  
Orange | 2833124



**STAPLE CAP**

Cypress | 2864568  
Black | 2833127  
Navy | 2833128



**TONAL HAT**

Orange | 2864564  
Black/Red | 2833497  
Navy | 2833496



**LOOSE FIT BEANIE**

Olive | 2864708  
Fuchsia | 2864709  
Black/White | 2864710



**MARLED CUFF BEANIE**

Pink | 2864707  
Gray | 2864706



**FAIR ISLE POM BEANIE**

White | 2864701  
Teal | 2864702



**JOURNEY CAP**

Light Blue | 2864570  
Black | 2833136  
Blue | 2833137



**LEATHER PATCH HAT**

Cypress | 2864569  
Black | 2833129  
Gray | 2833130



**HIGHLAND CAP**

Red | 2864567  
Navy | 2833126  
Gray | 2833506



**SPACE DYE POM BEANIE**

Blue | 2864703  
Pink | 2864704



**FAIR ISLE TASSEL BEANIE**

Black/White | 2864711



**REMOVABLE POM BEANIE**

Red | 2864705  
Black | 2833119  
Green | 2861513  
Gray | 2861514





**BLUE/GRAY** 2864519  
**BLACK** 2833041  
**RADIANT GREEN** 2833040

## SOFTSHELL JACKET

VERSATILE LIGHTWEIGHT JACKET THAT'S PERFECT FOR EVERYDAY WEAR

S-3XL

- Casual jacket armed with rugged and warm features for everyday wear
- Superior DWR prevents precipitation from saturating the jacket's exterior
- Lined with 280g of soft fleece for warmth
- Removable hood and underarm venting, three external pockets and one internal chest pocket



**BLACK** 2862563  
**BLUE** 2862564

## WORK JACKET

WARM AND RUGGED JACKET THAT'S TOUGH FOR WORK & STYLISH FOR PLAY

S-3XL

- 100% nylon shell is coated with Durable Water Repellency to help keep you dry
- Built-in action back for increased range of motion
- 80g 3M™ Thinsulate™ for added warmth with brushed flannel trim
- One inner and four outer pockets for storage



**BLACK** 2861433  
**DEEP LAGOON** 2864520

## FORCE PUFFER JACKET

PACKABLE JACKET OFFERS LIGHTWEIGHT PROTECTION & INCREDIBLE WARMTH

S-3XL

- 140g 3M™ Thinsulate™
- Two external hand pockets and one internal media pocket
- Rugged YKK™ zippers
- Compactable into travel pocket



**BLUE** 2864530  
**RADIANT GREEN** 2833042  
**BLACK/GRAY** 2862458

## TITAN MID-LAYER

VERSATILE MID-LAYER CAN BE WORN ALONE OR AS AN EXTRA LAYER

S-3XL

- 319g Polartec™ Thermal Pro™ Rib Sweater provides great warmth
- Breathable material moves sweat to the outer surface
- Nylon overlay is comfortable and light



## PLAID FLANNEL SHIRT

Blue | S-3XL | 2864673  
 Teal | S-3XL | 2864674



## STAPLE HOODIE

Blue | S-3XL | 2864607  
 Deep Lagoon | S-3XL | 2864608  
 Gray | S-3XL | 2833096  
 Black | S-3XL | 2833095



## JOURNEY HOODIE

Purple | S-3XL | 2864537  
 Radiant Green | S-3XL | 2833098  
 Black | S-3XL | 2862515



## UPF POLARIS HOODIE TEE

Pink | S-3XL | 2833102  
 Teal | S-3XL | 2833103



## ADVENTURE CREW

Misty Blue | S-2XL | 2864602  
 Black/Radiant Green | S-2XL | 2833100  
 Green | S-2XL | 2833101  
 Dusty Rose | S-2XL | 2862513



## ADVENTURE LONG SLEEVE

White | S-3XL | 2864611  
 Gray | S-3XL | 2833107  
 Navy | S-3XL | 2833108



## CORE TANK

Black | S-3XL | 2833161  
 Gray | S-3XL | 2833160



## FLAG TEE

Gray | S-3XL | 2833163  
 White | S-3XL | 2833162



## VENTURE TEE

Heather Gray | S-3XL | 2864625  
 Turquoise | S-3XL | 2864626



# HOME & COLLECTIBLES



**POLARIS KEY RACK**  
12" x 8" | 2864718



**POLARIS LED SIGN**  
31.5" x 6.5" | 2862736



**POLARIS RACING LED SIGN**  
31.5" x 9" | 2862737



**ALUMINUM SIGN**  
22" | 2860867



**WOOD SIGN**  
10.5" x 24" | 2860866



**POLARIS STEEL SIGN**  
14" x 36" | 2860868



**POLARIS PARKING SIGN**  
2869934



**POLARIS FLAG**  
3' x 5' | 2869928



**POLARIS RACING MUG**  
2864716



**12 OZ CAMPER MUG**  
2861612



**23 OZ WATER BOTTLE**  
2862685



**15 OZ CAMPFIRE MUG**  
2861613



**POLARIS PVC COASTERS**  
2864715



**POLARIS LOWBALL GLASSES WITH COASTERS (SET OF 2)**  
2864721



**FLASK**  
2860812



**PREMIUM KOOZIE**  
2860829



**KICKBACK ROCKER**  
2862626



**FREESTYLE ROCKER**  
2862625



**EASY CHAIR**  
2862627



**QUICK-E-SEAT**  
2862624



**FOLDABLE TABLE**  
2861620



**LEATHER LOOP KEYCHAIN**  
2861615



**KEYCHAIN**  
2861614



**POLARIS LEATHER KEY CHAIN**  
2861616



**DECK OF CARDS**  
2860816



**POLARIS NOTEBOOK**  
2860831



**HITCH COVER**  
2861623



**LICENSE PLATE HOLDER**  
2862687

APPAREL

POLARIS XPEDITION APPAREL

JERSEYS, GLOVES & HEATED APPAREL

HELMETS & GOGGLES

MEN'S APPAREL

BALL CAPS & BEANIES

WOMEN'S APPAREL

HOME & COLLECTIBLES



# KEEP CHASING THE WILD



## BUILD THE MACHINE TO TAKE YOU THERE

Customize your Polaris XPEDITION with exactly what you need to ride comfortably and explore farther than you've ever gone before.

**STEP 1:** CHOOSE MODEL

**STEP 2:** CHOOSE TRIM

**STEP 3:** CHOOSE COLOR

**STEP 4:** CHOOSE ACCESSORIES

### EXPERIENCE OFF-ROAD LUXURY

Windshields & Rear Panels	P. 20
Doors	P. 22
Cab Comfort	P. 24

### NEXT LEVEL VERSATILITY

Storage	P. 28
Lighting	P. 44
Wheels & Tires	P. 48
Winches	P. 56

### MAINTAIN YOUR POLARIS XPEDITION

Maintenance	P. 58
Oil & Lubricants	P. 60

### EVERYTHING YOU NEED TO GEAR UP

Apparel	P. 74
Helmets	P. 78

## BUILD YOUR OWN AT [POLARIS.COM/XPEDITION](https://Polaris.com/XPEDITION)

Warning: Polaris off-road vehicles can be hazardous to operate and are not intended for on-road use. Driver must be at least 16 years old with a valid driver's license to operate. All riders should always wear helmets, eye protection and protective clothing and footwear. Read, understand and follow your owner's manual. Ride within the limits of your own abilities and never engage in stunt or exhibition driving. Never ride under the influence of drugs or alcohol. All riders should take a safety training course. Call 800-342-3764 for additional information.

Unless noted, trademarks are the property of Polaris Industries Inc. 3M® and Thinsulate® are registered trademarks of 3M Company. 509® is a registered trademark of Teton Outfitters, LLC. Apple® is a registered trademark of Apple Inc. App Store® is a registered trademark of Apple Inc. Bluetooth® is a registered trademark of Bluetooth Sig, Inc. Caliber® is a registered trademark of Caliber, Inc. Facebook® is a service trademark of Facebook, Inc. Fidlock® is a registered trademark of Fidlock GmbH. FOX® is a registered trademark of Fox Factory Inc. Gatorade® is a registered trademark of STOKELY-VAN CAMP INC. CORPORATION Google Play® is a registered trademark of Google, Inc. GoPro® is a registered trademark of GoPro, Inc. Instagram™ is a service trademark of Instagram, LLC. JBL® is a registered trademark of HARMAN INTERNATIONAL INDUSTRIES, Inc. MAXTRAX® is a registered trademark of MAXTRAX AUSTRALIA PTY LTD LIMITED LIABILITY COMPANY. Morflex® is a registered trademark of FNA Group, Inc. NOCO® and NOCO GENIUS® are registered trademarks of The Noco Company. Polartec® and ThermalPro® are registered trademarks of MMI-IPCO, LLC. RAM® is a registered trademark of National Products, Inc. RHINO-RACK® is a registered trademark of Rhino Rack Australia Pty Limited. RIGID® is a trademark of JST Performance, LLC b/a Rigid Industries. SMART BOARD® is a registered trademark of SMART TECHNOLOGIES ULC UNLIMITED LIABILITY CORPORATION CANADA. TEKVEST® is a registered trademark of 1181676 ONTARIO INC. Tiger Drylac® is a registered trademark of TIGER COATINGS GMBH & CO. Twitter™ is a service trademark of Twitter, Inc. Velcro® is a registered trademark of VELCRO BVBA PRIVATE LLC BELGIUM. WALKER EVANS RACING® is a registered trademark of Walker Evans Enterprises Incorporated. Yeti® is a registered trademark of Yeti Coolers, LLC. YKK® is a registered trademark of YKK Corporation. YouTube® is a registered trademark of Google Inc. Prices, Fitment and Availability are subject to change at any moment. Copyright © 2023 Polaris Industries Inc. All rights reserved.



# KEEP CHASING THE WILD

## GET THE BEST OWNER EXPERIENCE OUT THERE

Our goal is to make every day of ownership a smooth ride. Sign in for access to everything you need, plus exclusive offers and more.

[OFFROAD.POLARIS.COM/ACCOUNT](https://offroad.polaris.com/account)



### MY GARAGE

- Vehicle Profile & Accessory Details
- Maintenance Schedules
- Schedule Service
- Manuals & Warranty Info



### MY RIDES & COMMUNITY

- My Tracked Rides
- My Planned Routes & POIs
- My Community Activities & Events
- Explore Polaris Adventures



### MY SHOPPING

- Recommended Accessories
- Purchase History
- My Dealer
- Access to Polaris Pros



Make sure vehicle is level, gear selector is in PARK and the wheels are chocked when the tent is deployed.

CONNECT ONLINE  
SEARCH "POLARISORV"



## BUILD YOUR DREAM MACHINE & EXPLORE FARTHER

1 CHOOSE  
MODEL

2 CHOOSE  
TRIM

3 CHOOSE  
COLOR

4 CHOOSE  
ACCESSORIES



VISIT [POLARIS.COM/PolarisXPEDITION](https://polaris.com/PolarisXPEDITION)

TO SEE VEHICLE OPTIONS AND VIEW ACCESSORIES  
ON YOUR NEW MACHINE FROM EVERY ANGLE!

**POLARIS**

Think Outside