



Hardcoat Full Tilt Windshield

For Polaris RZR

P/N 2010

ASSEMBLY / OWNERS MANUAL

Before you begin, please read and understand these instructions. Also review the box contents to ensure all parts are accounted for.



Kolpin Outdoors, Inc. | 9955 59th Ave N | Plymouth, MN 55442

(877) 956-5746 or (763) 478-5800 | www.kolpin.com | customerservice@kolpin.com

BEFORE YOU BEGIN

Thank You and congratulations on your purchase! Kolpin windshields are the most durable windshields in the industry. With proper installation, care, and maintenance, your Kolpin windshield will last for years to come! Before You Begin:

- Inspect the contents of the package to ensure all parts and tools are accounted for. If any hardware is missing, do not return to the store. Call Kolpin directly for assistance. Toll Free 1-877-956-5746.
- Please read and understand all assembly instructions, notices and warnings before assembling and operating your Kolpin windshield.
- For proper installation, two people are highly recommended.
- Keep these instructions for future reference. Dealers: Provide owner manual to customer at time of purchase.
- To facilitate installation, make sure your vehicle is clean and free of debris.
- All directions referring to right and left are when the rider is sitting on the machine.



APPROXIMATE ASSEMBLY TIME: 30 minutes

TOOLS REQUIRED FOR INSTALLATION:

- 4 mm hex socket or hex key
- Shears or wire cutter
- Scissors

SAFETY INFORMATION

Our windshields were designed with your safety in mind. Please read and understand all Cautions, Notices and Warnings in this manual before you begin.

 **DANGER** 

TO AVOID SERIOUS INJURY OR DEATH:

1. OPEN POSITIONS ON FULL TILTING WINDSHIELDS ARE DESIGNED FOR LOW-SPEED RIDING ONLY.
2. IF VEHICLE IS TRAIERED FACING FORWARD, FULL TILTING WINDSHIELDS MUST BE IN THE CLOSED POSITION WITH TILTING T KNOBS TIGHTENED. FAILURE TO CLOSE AND SECURE THE WINDSHIELD MAY ALLOW AIRFLOW TO SEPARATE WINDSHIELD FROM VEHICLE, RESULTING IN AN ACCIDENT AND SEVERE INJURY OR DEATH. DO NOT TRAILER VEHICLE FACING REARWARD WITH WINDSHIELD INSTALLED. AIRFLOW MAY CAUSE WINDSHIELD TO SEPARATE FROM VEHICLE, RESULTING IN AN ACCIDENT AND SEVERE INJURY OR DEATH. REMOVE WINDSHIELD OR TRANSPORT VEHICLE IN ENCLOSED TRAILER.
3. UTVs ARE TO ONLY BE DRIVEN WITH CLEAN WINDSHIELDS FOR DRIVING VISIBILITY. IF DIRT OR DEBRIS ACCUMULATES ON THE WINDSHIELD WHEN RIDING, STOP THE UTV AT THE NEXT SAFE LOCATION ON THE TRAIL TO CLEAR OFF THE WINDSHIELD BEFORE RESUMING RIDING.
4. ONLY INSTALL WINDSHIELDS THAT ARE DESIGNED FOR THE MAKE AND MODEL OF THE UTV. INSTALLATION OF A WINDSHIELD THAT WAS NOT DESIGNED FOR THE UTV MAKE AND MODEL CAN IMPACT WINDSHIELD DURABILITY AND PERFORMANCE.
5. READ AND UNDERSTAND WINDSHIELD INSTRUCTION SHEETS AND UTV OWNER MANUAL BEFORE WINDSHIELD INSTALLATION OR OPERATING THE VEHICLE.
6. PERIODICALLY CHECK FOR WEAR AND TIGHTNESS OF ALL FASTENERS. REPLACE OR RE-TORQUE FASTENERS AS NECESSARY.

If any hardware is missing, do not return to the store. Call Kolpin directly for assistance.

Toll Free 1-877-956-5746.

Kit Contents:

Item	Part Description	Qty	Spare Kit PNs				
			K100137	K100135	PUR3356	PUR3360	K100136
1	Upper Windshield	1					
2	Lower Windshield	1					
3	Clamp Assembly - 1.75"	6	2				
4	Button Head - M6 x 18mm	32	6	2			8
5	Lock Washer - M6	32	6	6			
6	Dome Shoulder Washer - M6	12	4				
7	Windshield Slider	2		2			
8	T Knob - M6	2		2			
9	Upper Pivot	2		2			
10	Pivot Cylinder	4		4			
11	4.5 Degree Angle Adaptor	4					4
12	Lower Slider Mount	2		2			
13	Button Head - M6 x 38mm	4		4			
14	Bulb Seal - 36"	1			1		
15	Foam Seal - 36"	1				1	

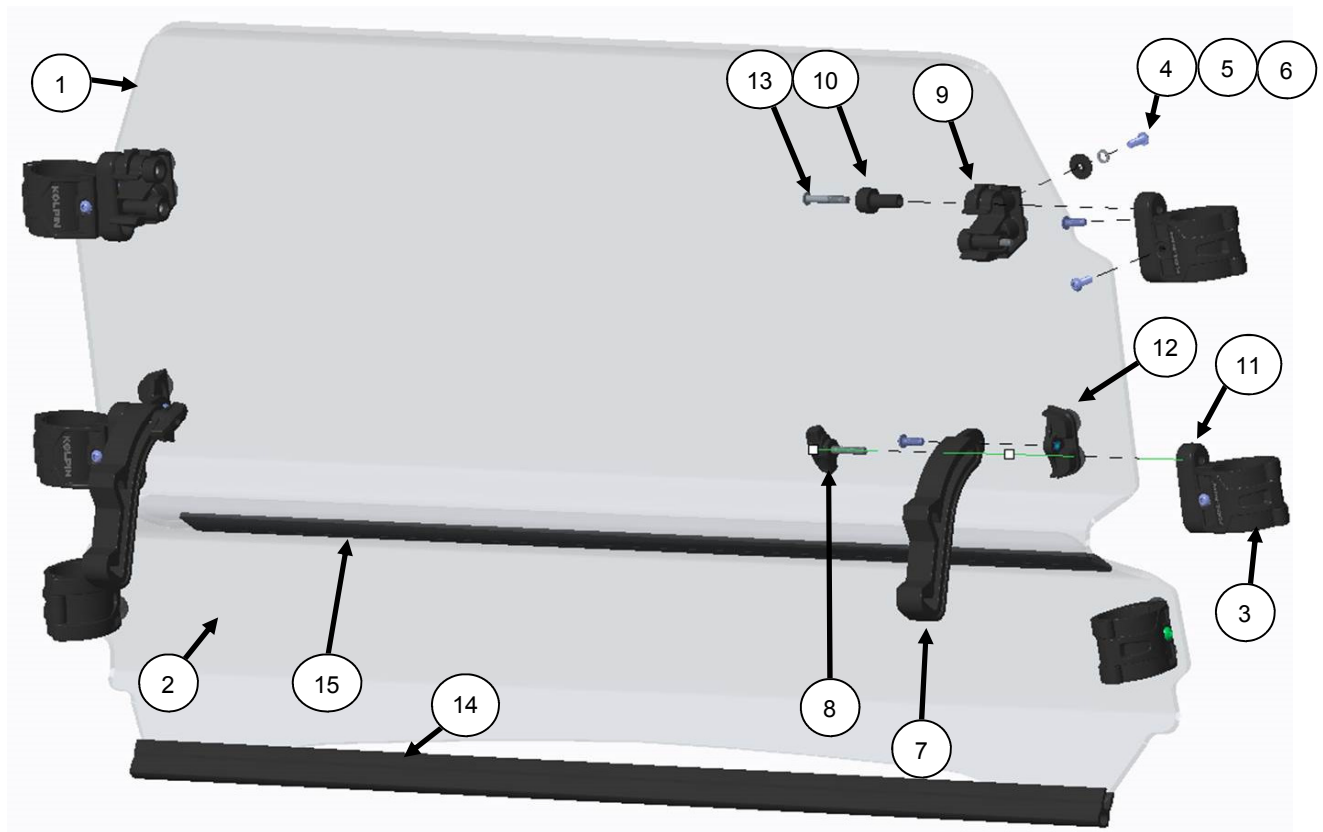

Installation Prep:

1. To facilitate installation, make sure that your vehicle is clean and free of debris.
2. All directions referring to right and left are when the rider is sitting on the machine.

Installation:

1. Remove Lower Windshield (Item 2) from the box and set on a clean flat surface with the protective film still in tact.
2. On the bottom edge, peel back ~2 inches of protective film from the inside and outside surfaces. Press the Bulb Seal (Item 14) into position along the bottom edge and cut the Bulb Seal to length using shears or a wire cutter. See Illustration 1-1 & 1-2.
3. On the top edge of the Lower Windshield (Item 2), peel back ~2 inches of protective film from the outside surface. Adhere the Foam Seal (Item 15) to the top edge by removing the adhesive backing, pressing the foam seal into position, and cutting to length. See Illustration 1-1 & 1-2.

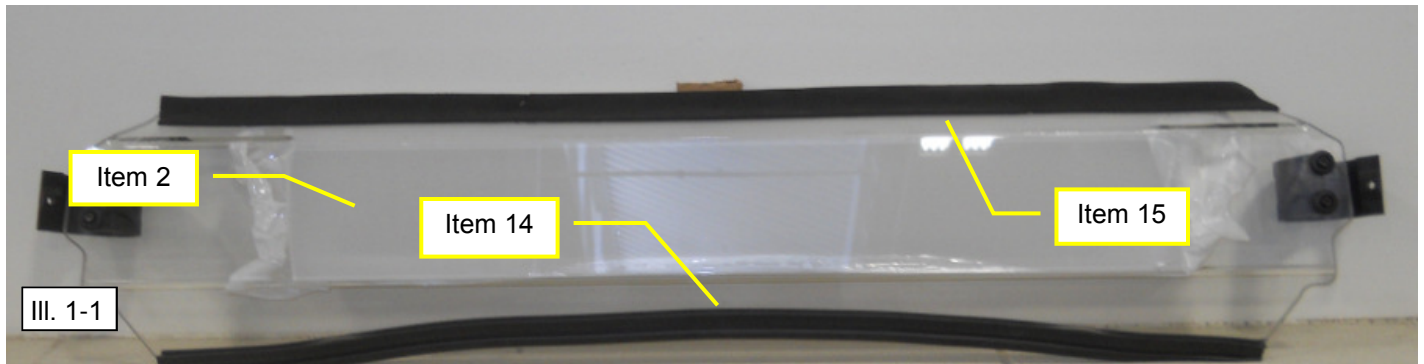

4. Assemble (1) Clamp (Item 3) on both sides to the Lower Windshield (Item 2) using (2) M6 x 18mm Button Heads (Item 4), (2) M6 Lock Washers (Item 5), and (2) Dome Shoulder Washers (Item 6). Do not tighten at this time to ease installation onto the vehicle. For proper fitment ensure "Kolpin" is facing outward on the clamps. See Illustration 1-2.

Note: Only assemble the clamps to the windshield, do not assemble the 3rd fastener on the clamp at this time. As the result, the male half of the clamp will be hanging freely.

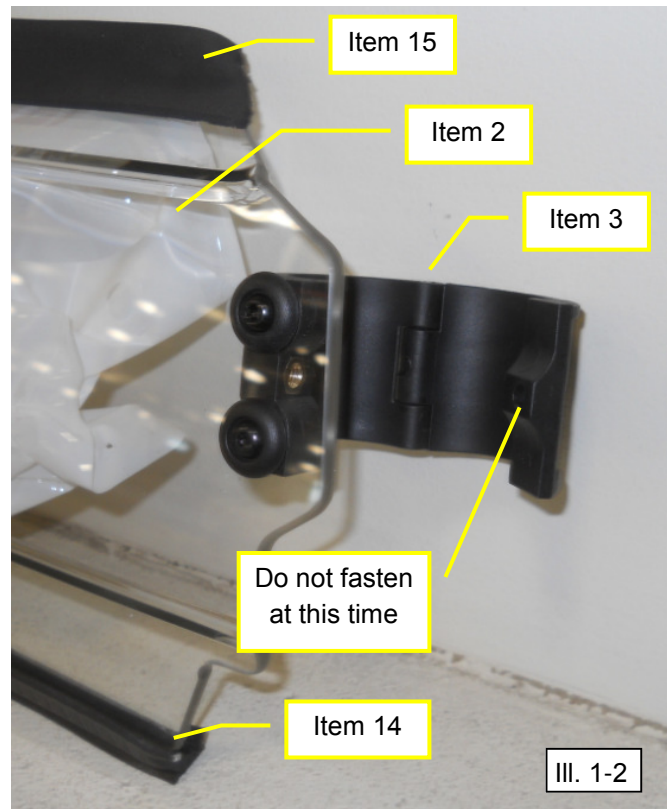

- Take the Lower Windshield Assembly and position onto the ROPS and against the hood surface. Install and tighten to specification (2) M6 x 18mm Button Head (Item 4) and (2) M6 Lock Washer (Item 5) into the clamp assemblies to secure the clamps around the ROPS. Then tighten to specification the (4) M6 x 18mm Button Heads that secure the clamps to the lower windshield. See Illustration 1-3 and 1-4.

 = T
6MM FASTENER TORQUE: 7 ft. lbs. (9 Nm)

First tighten the button heads to clamp around the

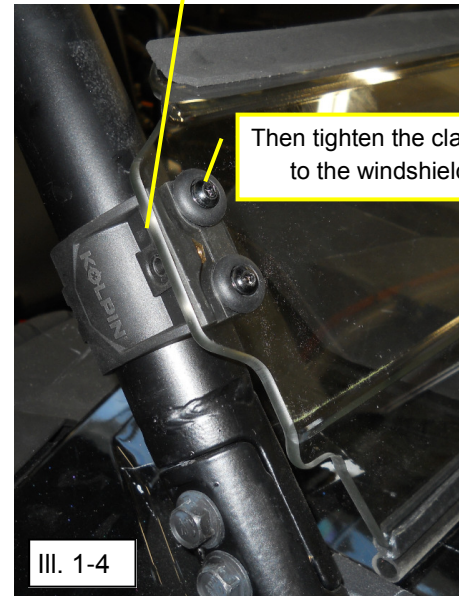

Then tighten the clamps to the windshield

- Remove Upper Windshield (Item 1) from the box and set on a clean flat surface with the protective film still in tact.
- Peel back the protective film on the edge of the upper windshield to ~2 inches inside the holes to prepare for components installation.
- Loosely install (2) Upper Pivots (Item 9) using (4) M6 x 18mm Button Heads (Item 4), (4) M6 Lock Washers (Item 5), and (4) Dome Shoulder Washers (Item 6) onto the Upper Windshield. Do not tighten at this time to ease installation onto the vehicle. See Illustration 1-5 & 1-6.

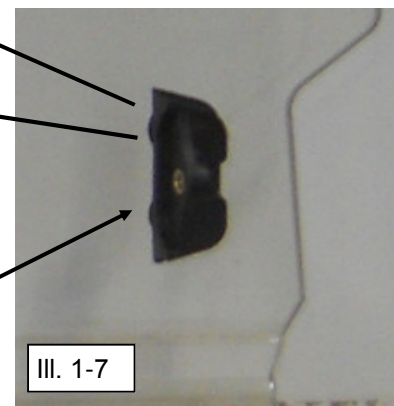
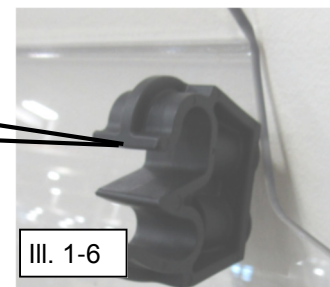

- Install (2) Lower Slider Mounts (Item 12) using (4) M6 x 18mm Button Heads (Item 4), (4) M6 Lock Washers (Item 5), and (4) Dome Shoulder Washers (Item 6) onto the Upper Windshield (Item 1). See Illustration 1-5 & 1-7.

Passenger's side shown; Mirror installation for driver's side.

10. Assemble (2) Pivot Cylinders (Item 10) to the 4.5 Degree Angle Adaptor (Item 11) using (2) M6 x 38mm Button Heads (Item 13) and (2) M6 Lock Washers (Item 5). Tighten to specification. See Illustration 1- 8.

 = T
6MM FASTENER TORQUE: 7 ft. lbs. (9 Nm)

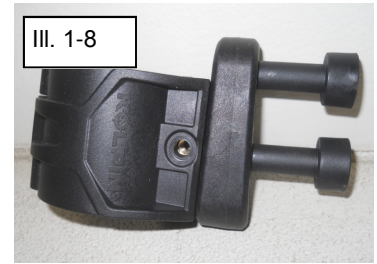

11. Assemble the Pivot Cylinder / Angle Adaptor Assembly to a Clamp (Item 3) using (2) M6 x 18mm Button Heads (Item 4). Repeat to create a second Pivot Cylinder / Angle Adaptor / Clamp Assembly.
12. Slide the (2) Pivot Cylinder / Angle Adaptor / Clamp assemblies into position on the (2) Upper Pivots (Item 9) with the clamps outward from the upper pivot. See Illustration 1-9 & 1-10.
13. Assemble (1) Windshield Slider (Item 7) to (1) Lower Slider Mount (Item 12) using (1) M6 x 18mm Button Head (Item 4) on the passenger's side. Windshield Slider (Item 7) is to be positioned inside of the Lower Slider Mount (Item 12). Repeat for driver's side. See Illustration 1-9 & 1-11.
14. Assemble the Angle Adaptor (Item 11) using (2) M6 x 18mm Button Head (Item 4) onto Clamp Assembly (Item 3). Assemble the Clamp / Angle Adaptor assembly onto Windshield Slider (Item 7) using a T Knob (Item 8) on the passenger's side. The T Knob should be positioned inside the Windshield slider. Repeat for driver's side. See Illustration 1-9 & 1-11.

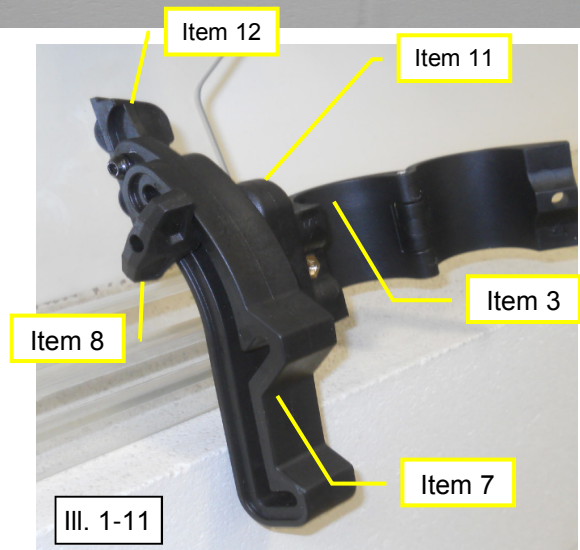
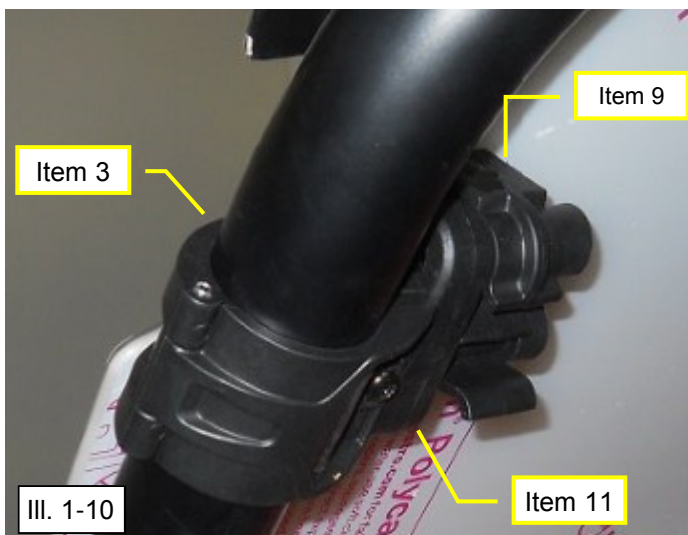
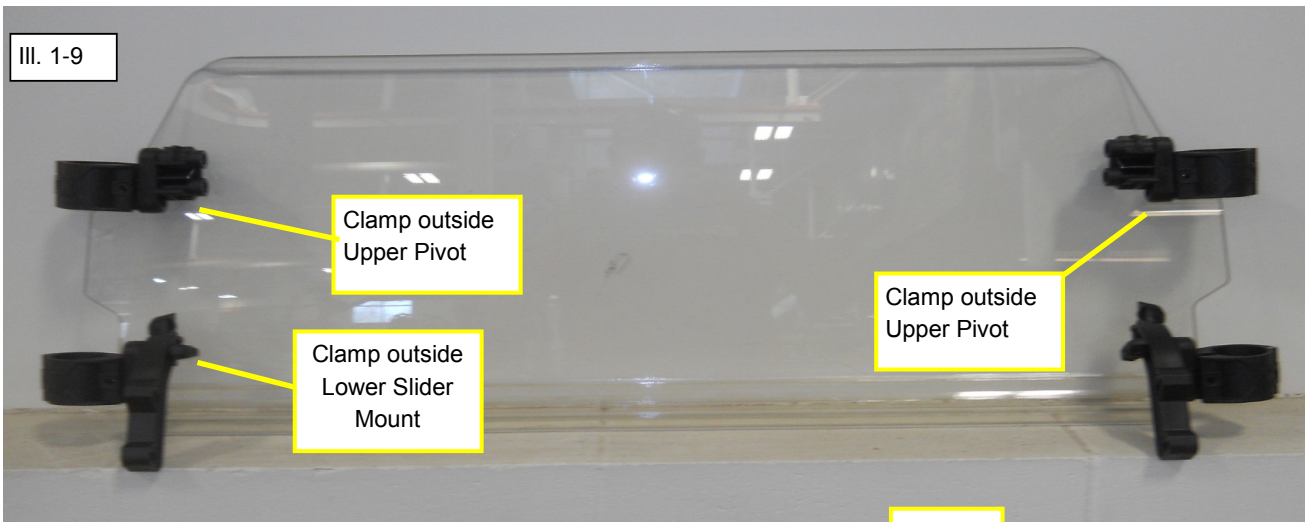

- Ensure the clamps are open. With one person on the drivers side and one the passengers side, lift and position the Upper Windshield assembly onto the ROPS with the bottom edge contacting Foam Seal (Item 15) on the Lower Windshield assembly. See Illustration 1–12.



- Loosely assemble (4) M6 x 18 Button Heads (Item 4) connecting the male & female clamp parts (Item 3) around the ROPS. See Illustration 1-13 & 1-14.
- Loosen the (2) T Knobs (item 8) and open the Upper Windshield assembly to the maximum vent position and tighten the (2) T Knobs (item 8) . See Illustration 1-15.
- Tighten to specification (4) M6 x 18mm Button Heads (Item 4) that connect the male & female clamp parts together (Item 3). Then tighten the (8) M6 x 18mm Button Heads (Item 4) that assemble the Upper Pivots (Item 9) and Lower Slider Mount (Item 12) to the Upper Windshield (Item 1). See illustration 1-13, 14, & 15.

 = T
6MM FASTENER TORQUE: 7 ft. lbs. (9 Nm)

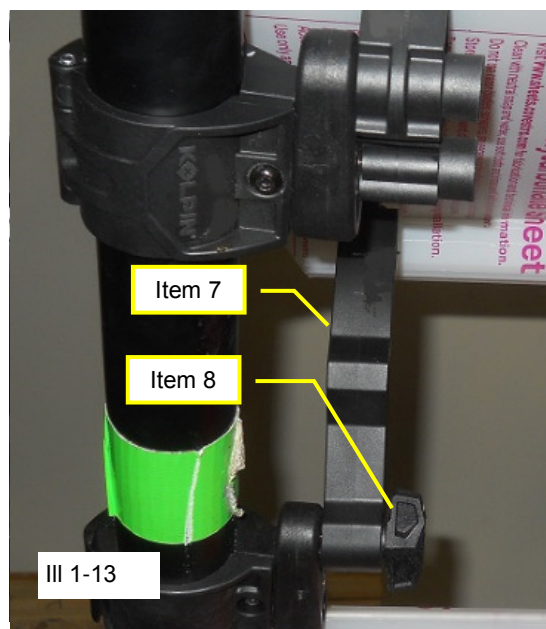

To Operate the Tilt Mechanism:

1. Loosen (without removing) the T Knobs (Item 8) and push on the Upper Windshield from the inside of the cab until the desired position is reached. Tighten T knobs. Note: There are three positions on the Windshield Slider, Closed, Half Open, and Fully Extended.

Note: Open positions are designed for low-speed operation ONLY. Windshield must be secured and in the closed position for high speed riding or transporting the vehicle.

To Remove the Upper Windshield (See Illustration 1-16).

1. Remove the T Knobs (Item 8).
2. Pivot the Upper Windshield until the windshield is horizontal.
3. Push the Upper Windshield towards the cab gently to move the Upper Windshield Assembly ~1/2" on Upper Pivot.
4. Lift the Upper Windshield Assembly slightly to clear the Pivot Cylinders and remove the Upper Windshield Assembly from the vehicle.

Note: To reattach the Upper Windshield to the vehicle, follow the reverse order of Steps 4, 3, 2, 1.

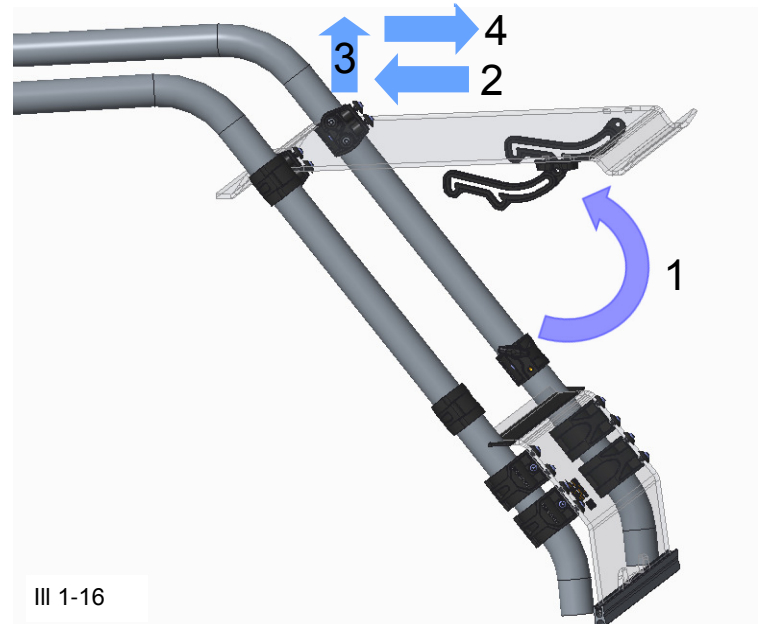

One Year Limited Warranty

For the period of one (1) year from the purchase date, Kolpin will replace for the original purchaser, free of charge, any part or parts found upon examination by Kolpin to be defective in material, workmanship, or both.

All transportation costs incurred submitting product to Kolpin for warranty consideration must be borne by the purchaser. If Kolpin determines that the product must be returned to the factory for credit, please call 1-877-956-5746 for a Return Merchandise Authorization (RMA) number and shipping instructions.

This warranty does not apply to parts that have been damaged by accident, alteration, abuse, improper maintenance, normal wear, or other causes beyond the manufacturer's control. In order to protect you and your ATV, certain parts of the accessory system and/or hardware are designed to fail when the equipment is over-stressed. Parts that are lost due to loosening and improper maintenance are not covered under warranty. This warranty does not cover removal or reinstallation labor fees of the plow system and related components.

Peripheral products such as engines, electric motors, and actuators may carry an original manufacturer's warranty. Most hardware is general in nature and is easily obtained locally. Be sure to replace with minimum metric class 8.8 specifica-