



Rear Windshield Rear Panel

For Yamaha Wolverine

Part # 2781

ASSEMBLY / OWNERS MANUAL

Before you begin, please read and understand these instructions. Also review the box contents to ensure all parts are accounted for.



Kolpin Outdoors, Inc. | 9955 59th Ave N | Plymouth, MN 55442

(877) 956-5746 or (763) 478-5800 | www.kolpin.com | customerservice@kolpin.com

© 2018 Kolpin Outdoors Inc. REV 01

BEFORE YOU BEGIN

Thank You and congratulations on your purchase! Kolpin windshields are the most durable windshields in the industry. With proper installation, care, and maintenance, your Kolpin windshield will last for years to come! Before You Begin:

- Inspect the contents of the package to ensure all parts and tools are accounted for. If any hardware is missing, do not return to the store. Call Kolpin directly for assistance. Toll Free 1-877-956-5746.
- Please read and understand all assembly instructions, notices and warnings before assembling and operating your Kolpin windshield.
- For proper installation, two people are highly recommended.
- Keep these instructions for future reference. Dealers: Provide owner manual to customer at time of purchase.
- To facilitate installation, make sure your vehicle is clean and free of debris.
- All directions referring to right and left are when the rider is sitting on the machine.



APPROXIMATE ASSEMBLY TIME: 30 minutes

TOOLS REQUIRED FOR INSTALLATION:

- 4 mm hex socket or hex key
- 10 mm combination wrench
- Shears or wire cutter
- Scissors

SAFETY INFORMATION

Our windshields were designed with your safety in mind. Please read and understand all Cautions, Notices and Warnings in this manual before you begin.

 **DANGER** 

TO AVOID SERIOUS INJURY OR DEATH:

1. OPEN POSITIONS ON FULL TILTING WINDSHIELDS ARE DESIGNED FOR LOW-SPEED RIDING ONLY.
2. IF VEHICLE IS TRAIERED FACING FORWARD, FULL TILTING WINDSHIELDS MUST BE IN THE CLOSED POSITION WITH TILTING T KNOBS TIGHTENED. FAILURE TO CLOSE AND SECURE THE WINDSHIELD MAY ALLOW AIRFLOW TO SEPARATE WINDSHIELD FROM VEHICLE, RESULTING IN AN ACCIDENT AND SEVERE INJURY OR DEATH. DO NOT TRAILER VEHICLE FACING REARWARD WITH WINDSHIELD INSTALLED. AIRFLOW MAY CAUSE WINDSHIELD TO SEPARATE FROM VEHICLE, RESULTING IN AN ACCIDENT AND SEVERE INJURY OR DEATH. REMOVE WINDSHIELD OR TRANSPORT VEHICLE IN ENCLOSED TRAILER.
3. UTVs ARE TO ONLY BE DRIVEN WITH CLEAN WINDSHIELDS FOR DRIVING VISIBILITY. IF DIRT OR DEBRIS ACCUMULATES ON THE WINDSHIELD WHEN RIDING, STOP THE UTV AT THE NEXT SAFE LOCATION ON THE TRAIL TO CLEAR OFF THE WINDSHIELD BEFORE RESUMING RIDING.
4. ONLY INSTALL WINDSHIELDS THAT ARE DESIGNED FOR THE MAKE AND MODEL OF THE UTV. INSTALLATION OF A WINDSHIELD THAT WAS NOT DESIGNED FOR THE UTV MAKE AND MODEL CAN IMPACT WINDSHIELD DURABILITY AND PERFORMANCE.
5. READ AND UNDERSTAND WINDSHIELD INSTRUCTION SHEETS AND UTV OWNER MANUAL BEFORE WINDSHIELD INSTALLATION OR OPERATING THE VEHICLE.
6. PERIODICALLY CHECK FOR WEAR AND TIGHTNESS OF ALL FASTENERS. REPLACE OR RE-TORQUE FASTENERS AS NECESSARY.

If any hardware is missing, do not return to the store. Call Kolpin directly for assistance.

Kit Contents:

Assembly			Spare Kit PNs					
Item	Part Description	Qty	K100137	K100121	K100172	K100178	K100189	PUR3368
1	Upper Windshield	1						
2	Lower Windshield	1						
3	Clamp Assy - 1.75"	2	2					
4	Clamp Assy - 2.00"	4		2				
5	Button Head - M6 x 18mm	22	6	6	2			
6	Button Head - M6 x 38mm	4				2		
7	Lock Washer - M6	18	6	6	2	2		
8	Domed Shoulder Washer - M6	20	4	4	2	2		
9	Flanged Locknut - M6	8			2	2		
10	Clamp Insert	2					2	
11	Stand Off Spacer	4			2	2		
12	Foam Seal - 48"	1						1

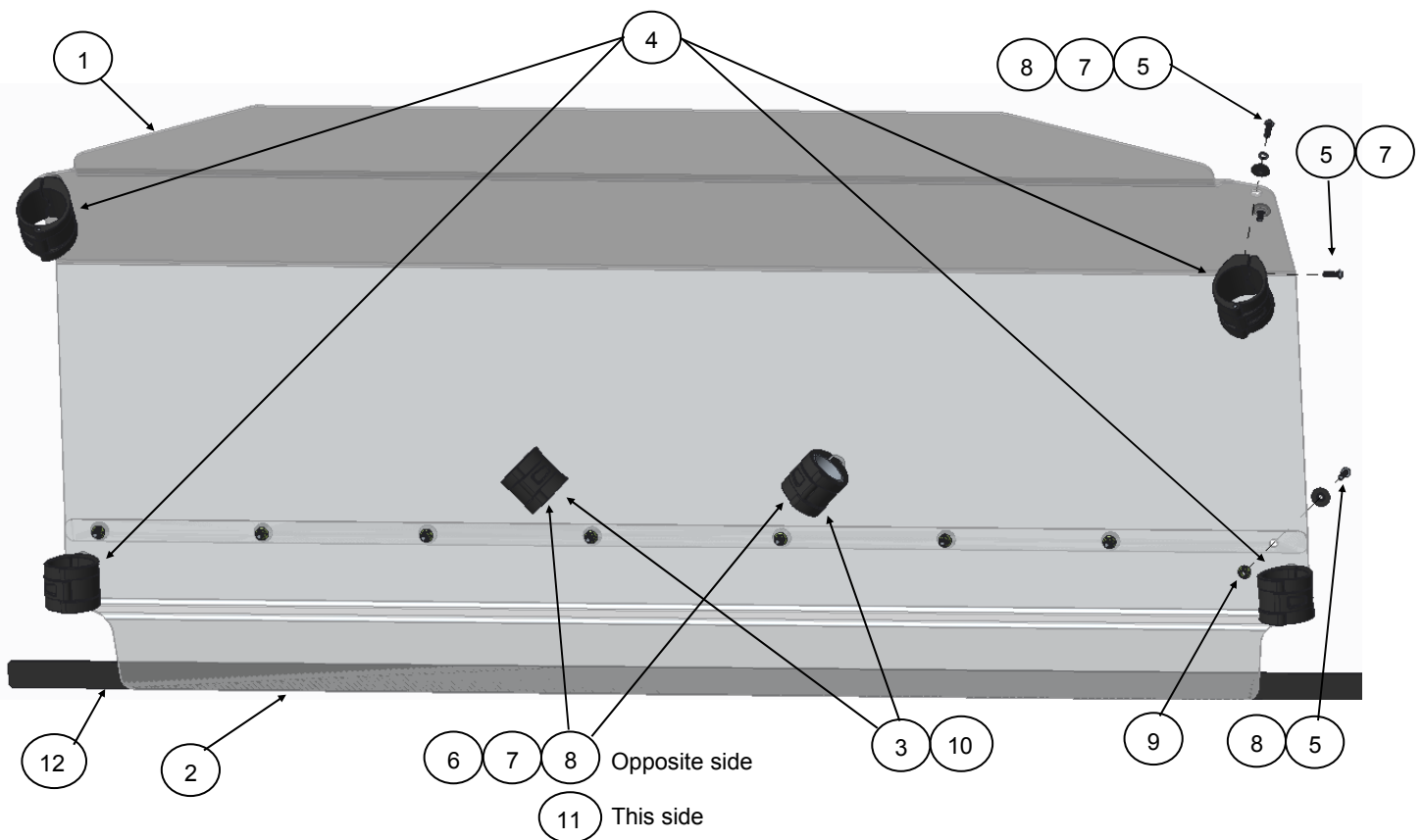

Installation Prep:

1. To facilitate installation, make sure that your vehicle is clean and free of debris.
2. All directions referring to right and left are when the rider is sitting on the machine.

Installation:

1. Remove Upper Windshield (Item 1) and Lower Windshield (Item 2) from the box and set on a clean flat surface with the protective film still in tact.
2. Peel back ~2 inches of protective film from the inside and outside surfaces of both panels.
3. Adhere the Foam Seal (Item 12) to the bottom edge of the Lower Windshield. Cut to length. See Illustration 1-1.
4. Assemble the Upper Windshield (Item 1) to the Lower Windshield (Item 2), using (8) M6 x 18mm Button Heads (Item 5), (8) Dome Shoulder Washers (Item 8), and (8) M6 Flange Nuts (Item 9). See Illustration 1-2.
5. Assemble (1) 2.00" Clamp (Item 4) to the Upper Windshield (Item 1) using (2) M6 x 18mm Button Heads (Item 5), (2) M6 Lock Washers (Item 7), and (2) Domed Shoulder Washer (Item 8). Do not tighten at this time to ease installation onto the vehicle. For proper fitment ensure "Kolpin" is facing outward on the clamps. Repeat for the other Upper Windshield Clamp. See Illustration 1-3.
6. With one person on the drivers side and one person on the passenger's side, lift and position the windshield assembly onto the ROPS. Loosely assemble (2) M6 x 18 Button Heads (Item 5) and (2) Lock Washers (Item 7) connecting the male & female clamp parts around the ROPS.
7. Repeat the clamp assembly process for the two clamps that secure the lower panel to the B pillar. See Illustration 1-4 and 1-5.

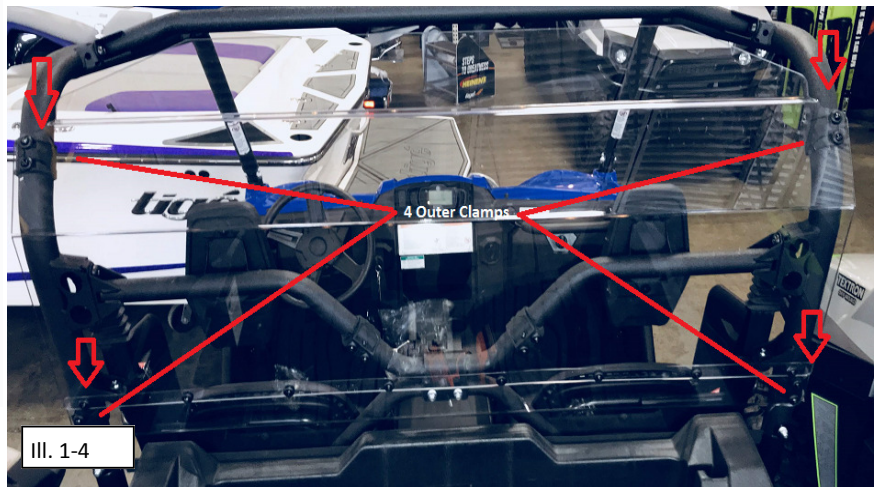
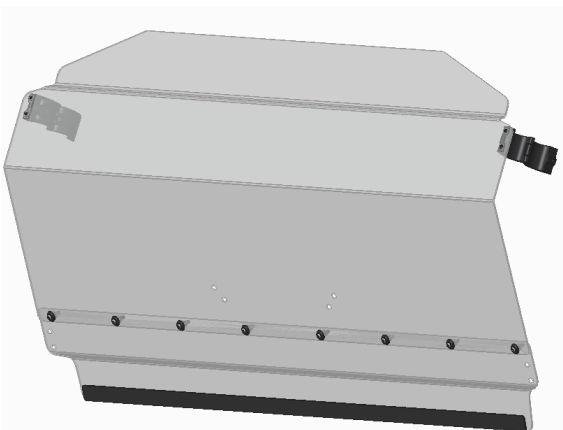
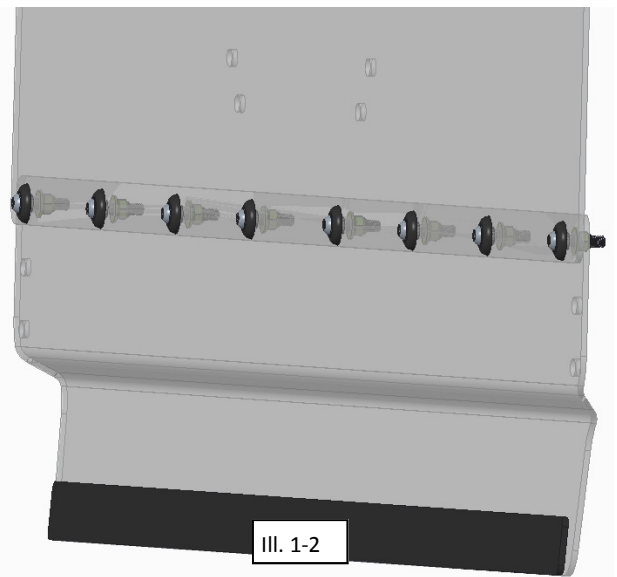
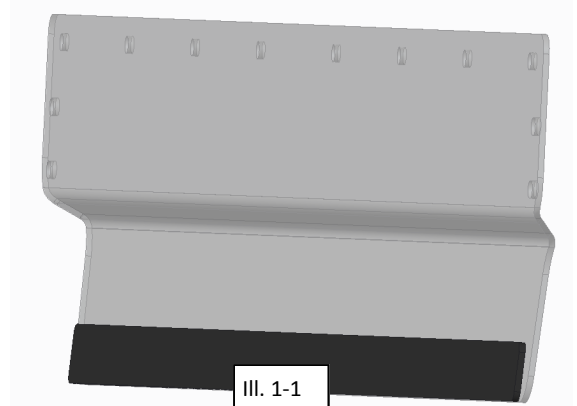

8. Install (2) middle 1.75" Clamps (Item 3) onto the ROPS using (1) Clamp Insert (Item 10) for each Clamp. Using (2) M6 x 38mm Button Heads (Item 6), (2) M6 Lock Washers (Item 7), (2) M6 Domed Shoulder Washers (Item 8) through the glass and installing (2) Standoff Spacers (Item 11) on each clamp and tighten to manufacture specs. See Illustration 1-5.

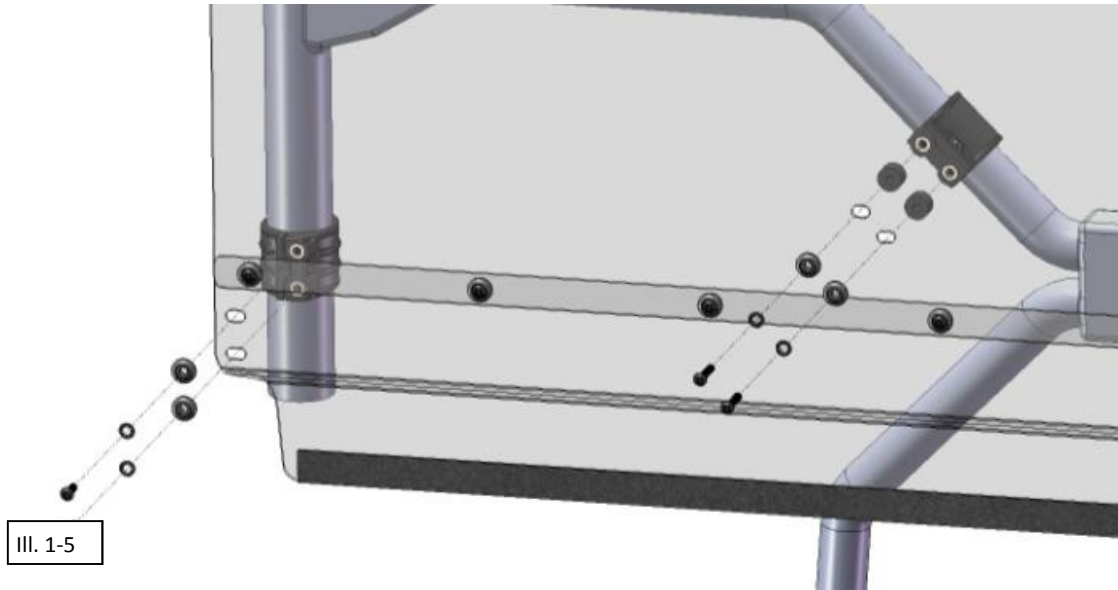

9. Tighten all remaining hardware to specification.

 = T
6MM FASTENER TORQUE: 7 ft. lbs. (9 Nm)

One Year Limited Warranty

For the period of one (1) year from the purchase date, Kolpin will replace for the original purchaser, free of charge, any part or parts found upon examination by Kolpin to be defective in material, workmanship, or both.

All transportation costs incurred submitting product to Kolpin for warranty consideration must be borne by the purchaser. If Kolpin determines that the product must be returned to the factory for credit, please call 1-877-956-5746 for a Return Merchandise Authorization (RMA) number and shipping instructions.

This warranty does not apply to parts that have been damaged by accident, alteration, abuse, improper maintenance, normal wear, or other causes beyond the manufacturer's control. In order to protect you and your ATV, certain parts of the accessory system and/or hardware are designed to fail when the equipment is over-stressed. Parts that are lost due to loosening and improper maintenance are not covered under warranty. This warranty does not cover removal or reinstallation labor fees of the plow system and related components.

Peripheral products such as engines, electric motors, and actuators may carry an original manufacturer's warranty. Most hardware is general in nature and is easily obtained locally. Be sure to replace with minimum metric class 8.8 specification.