

# RANGER POWER WINDOW DOOR KIT

## P/N 2879107; 2880503



# POLARIS®

### Application

MY 13 Ranger 900 XP

Before you begin, read these instructions twice and check to be sure all parts and tools are accounted for. Please retain these installation instructions for future reference and parts ordering information.

### This Kit Includes:

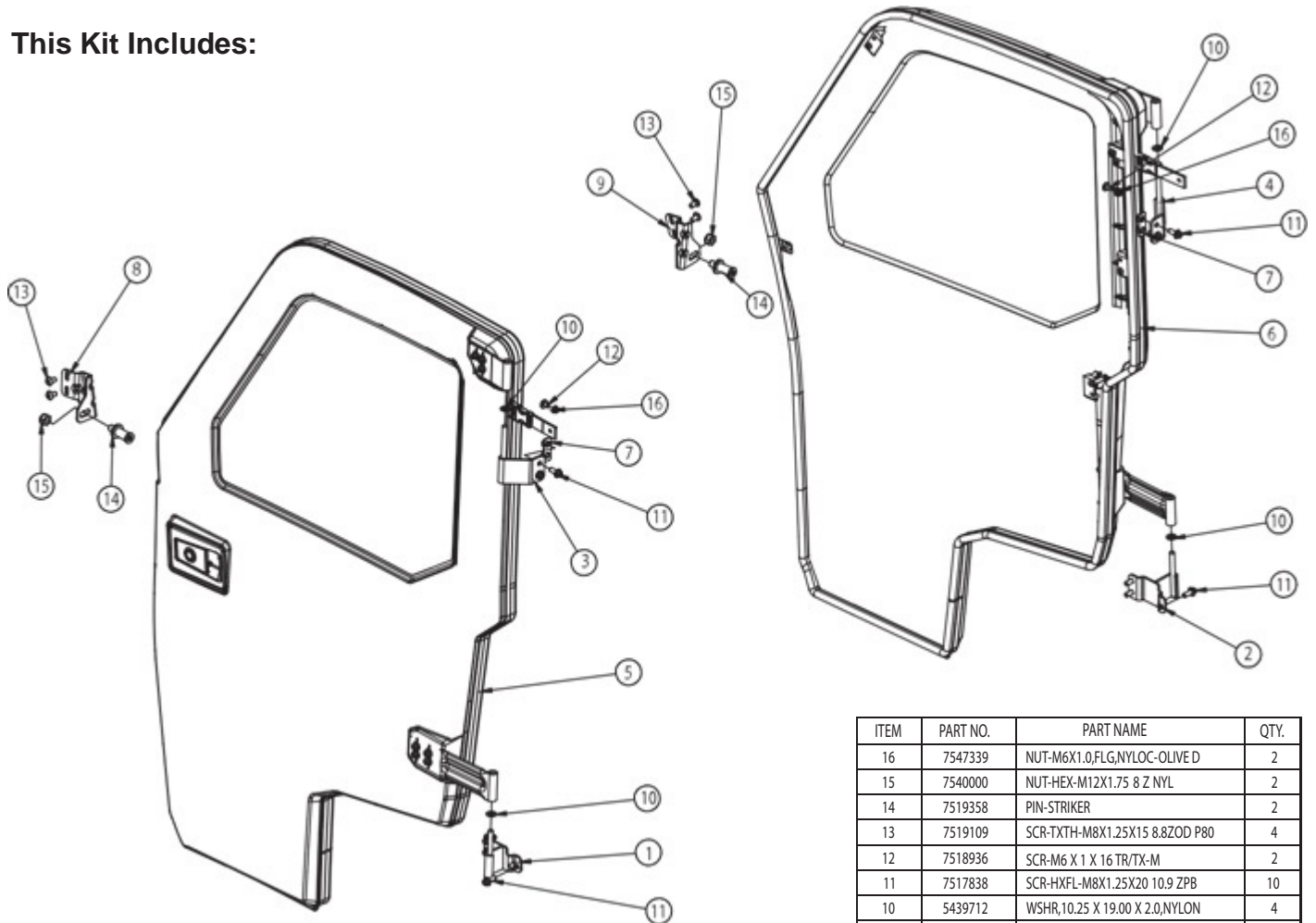

ITEM	PART NO.	PART NAME	QTY.
16	7547339	NUT-M6X1.0,FLG,NYLOC-OLIVE D	2
15	7540000	NUT-HEX-M12X1.75 8 Z NYL	2
14	7519358	PIN-STRIKER	2
13	7519109	SCR-TXTH-M8X1.25X15 8.8ZOD P80	4
12	7518936	SCR-M6 X 1 X 16 TR/TX-M	2
11	7517838	SCR-HXFL-M8X1.25X20 10.9 ZPB	10
10	5439712	WSHR,10.25 X 19.00 X 2.0,NYLON	4
9	5256944	BRKT-STRIKER,ADJUST,RH	1
8	5256943	BRKT-STRIKER,ADJUST,LH	1
7	5256140	PLATE-HINGE	2
6	2634870	DOOR,RH	1
5	2634869	DOOR,LH	1
4	1018775	WELD-HINGE,UPPER,RH	1
3	1018774	WELD-HINGE,UPPER,LH	1
2	1018773	WELD-HINGE,LOWER,RH	1
1	1018772	WELD-HINGE,LOWER,LH	1
	99554406	KIT-INSTRUCTIONS	1

### Tools Required:

Drill  
Utility Knife or Air Saw  
Soft Faced Hammer

Torx Bits  
Phillips Screwdrivers

Flathead Screwdriver  
Metric Wrenches

**IMPORTANT:** For your safety, and to ensure a satisfactory installation, perform all installation steps correctly in the sequence as shown on the attached instructions. Please wear safety glasses while performing the steps in the following instructions.

### INSTALLATION INSTRUCTIONS

1. Turn off vehicle and put into PARK.
2. Lift vehicle box.
3. Starting on either side of vehicle, loosen duct hose clamp located behind seat using a flathead screwdriver. Slide duct away from B-pillar cover. Figure 1.

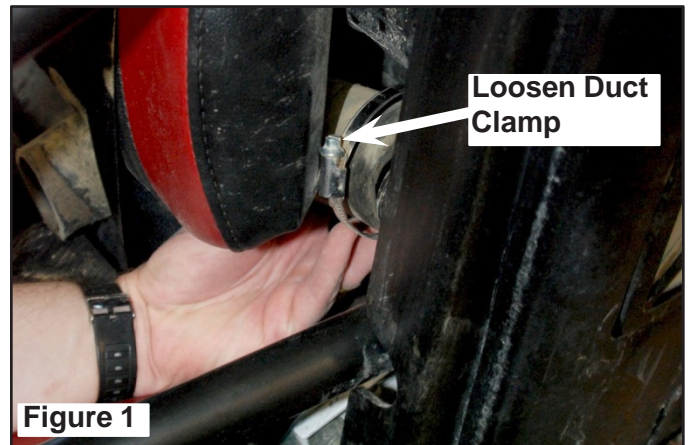

4. Remove B-pillar cover by removing two dart clips and three screws shown in Figures 2 and 3. Save fasteners for reinstallation.

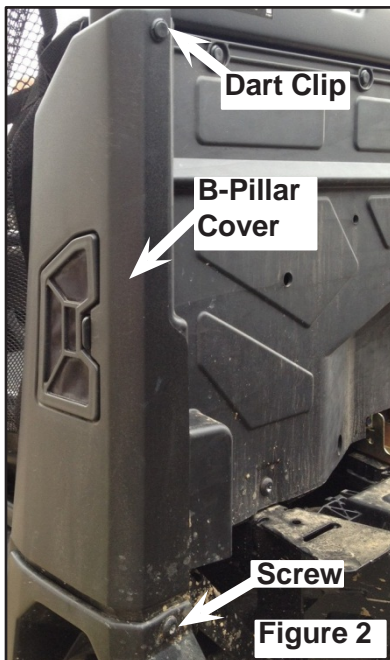

5. Cut a hole for the lower hinge bracket in the B-pillar cover with an utility knife or air saw. The area to be removed is marked on the back of the cover. Figure 4.

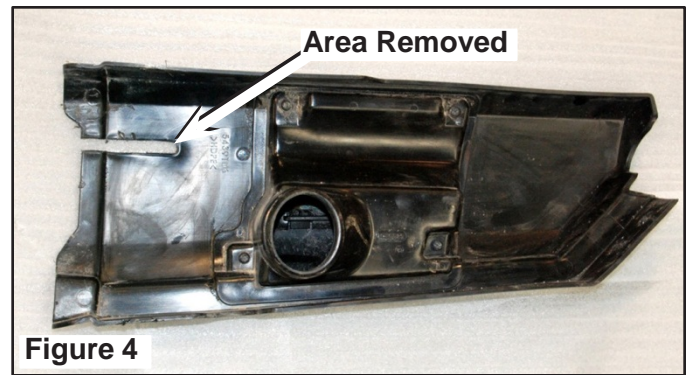

6. Install the lower hinge bracket (PN 1018773 RH; 1018772 LH) using three screws (PN 7517838) in the existing holes on the vehicle with a 13 mm socket wrench. Torque to 17 ft. lbs. (23 Nm). Figure 5.

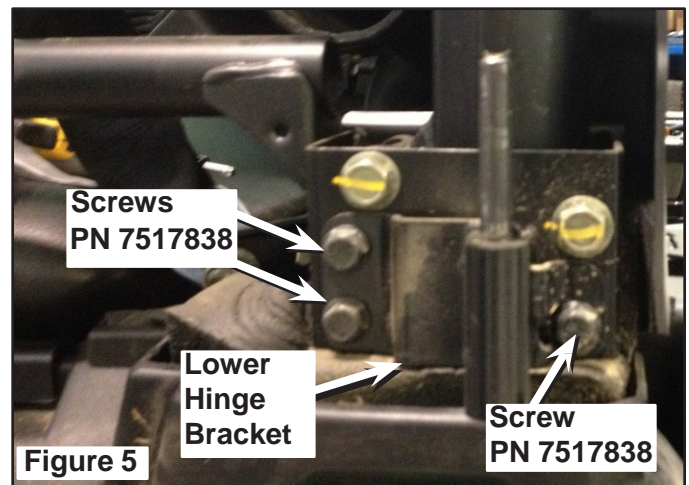

7. Install upper hinge bracket (PN 1018775 RH; 1018774 LH) by putting two bolts (PN 7517838) through bracket and threaded backing plate (5256140). Loosely tighten to frame for adjustments later. Figure 6. (Power window door kit contains (12) M8 fender washers. If needed, up to six can be installed per hinge bracket for better adjustment.)

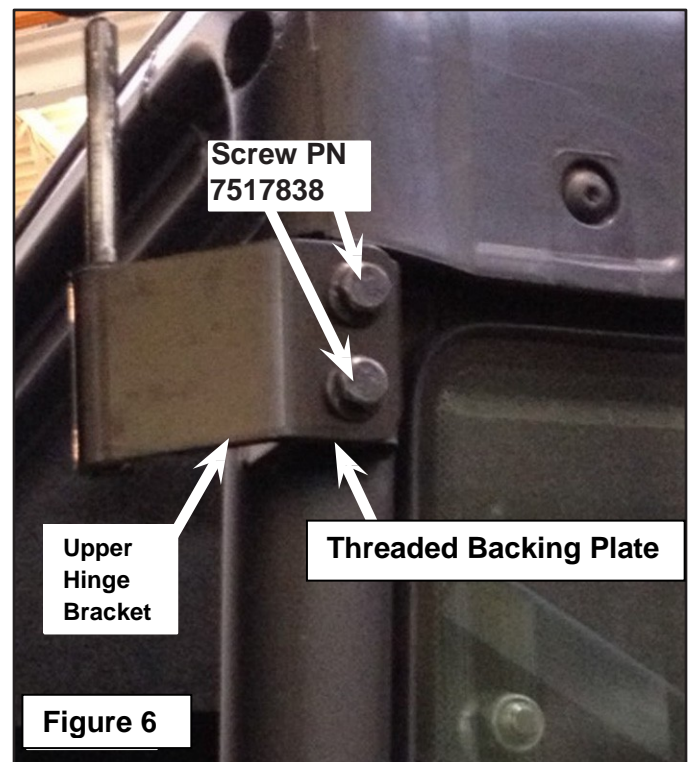



8. Attach striker adjusting bracket (PN 5256944 RH; 5256943 LH) with two screws (PN 7519109). Loosely tighten allowing for adjustment later. Figure 7.

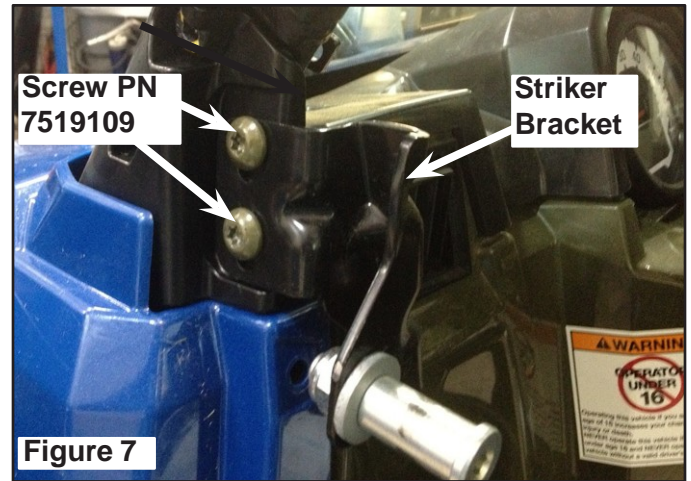

9. Replace the B pillar cover using the fasteners removed in Step 4. Figure 8.

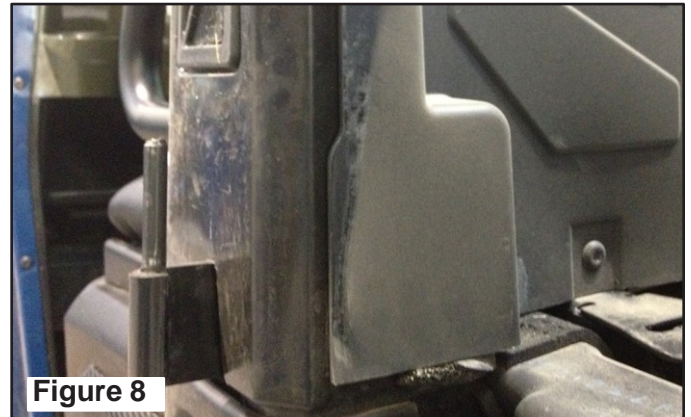

10. Place the doors on bracket pins by first installing nylon washers (PN 5439712) and placing the door on the top door bracket then on bottom door bracket. Figures 9a and 9b.

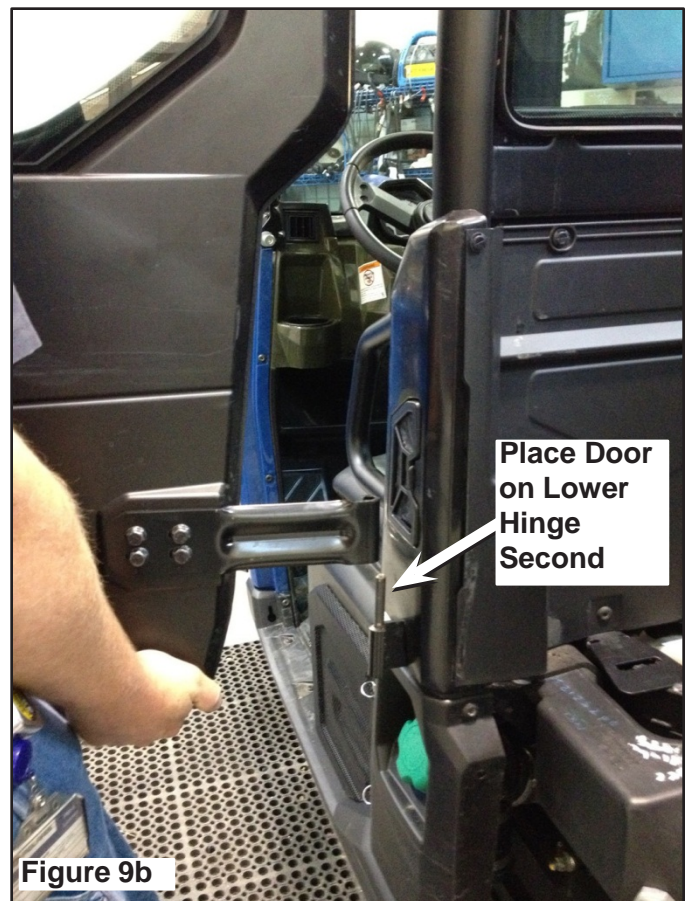



- Center door into place. Loosen door hinge brackets with a 13 mm socket as necessary to achieve proper fit. Figure 10.



- Once centered, tighten the lower hinge bracket bolts using a 13 mm socket wrench. Torque to 17 ft. lbs. (23 Nm). Figure 11.



- Once centered, tighten the upper hinge bracket bolts using a 13 mm socket wrench. Torque to 17 ft. lbs. (23 Nm). Figure 12.



14. Rotate door out 90° and tighten top two bolts. Torque to 17 ft. lbs. (23 Nm). Figure 13.



15. Install striker pin, (PN 7519358) washer (PN 5439712) and nut (PN 7540000) into striker bracket. Tighten until snug. Figure 14.

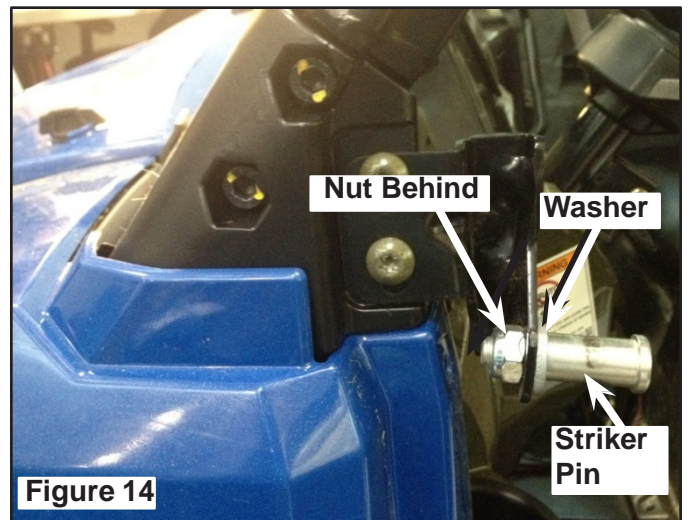

16. Close the door and adjust the striker pin to the correct position for door sealing. Figure 15.





17. Open and close the door and adjust the door latch and striker pin so the door opens and closes smoothly. Check alignment of door and adjust as necessary. Figure 16.
18. Torque striker nut to 30 ft. lbs. (40.6 Nm).



19. Install a M6 x 25mm screw, M6 spacer, and M6 nylock nut from the power window door kit into the hole shown in Figure 17. Attach the door tether to this hardware.
20. Repeat Steps 3 through 19 for the other door.

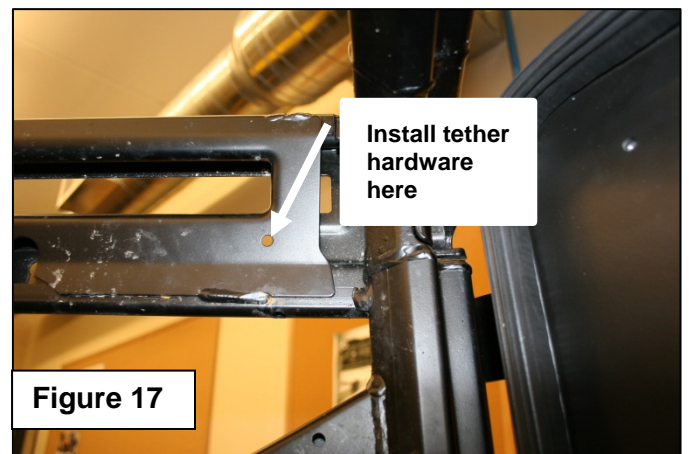

21. Use Figure 18 to reference the wiring harness installation in the following steps.

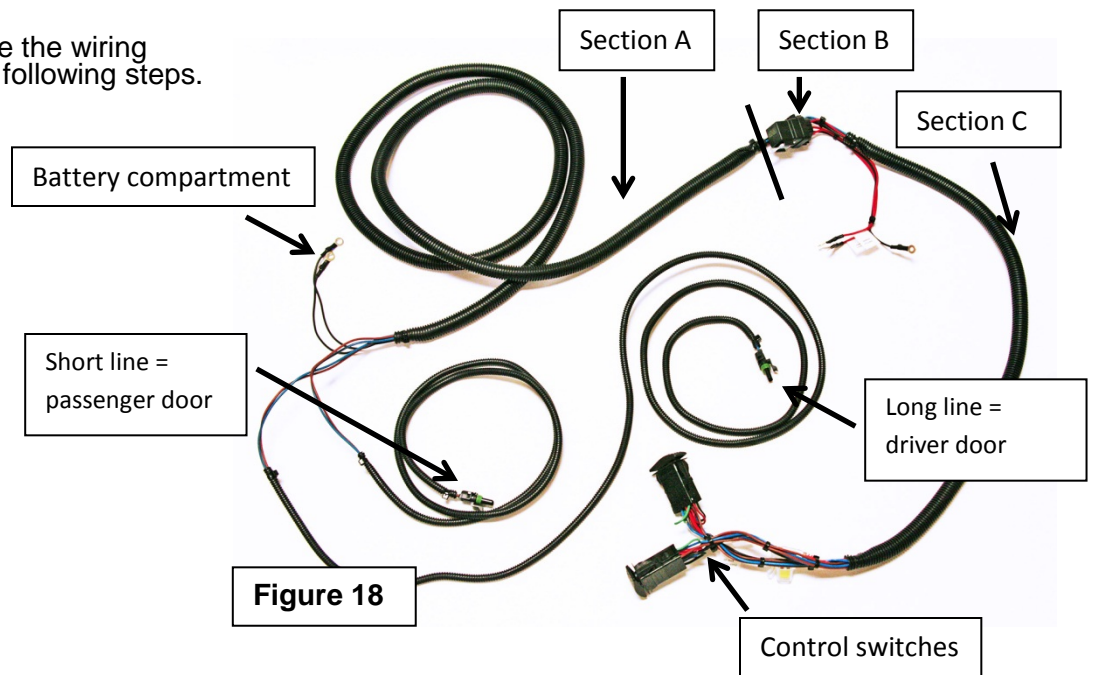

22. Remove passenger seat and storage compartment above battery.

23. Remove dash and hood panel. Figure 19.

Remove dash and hood panel

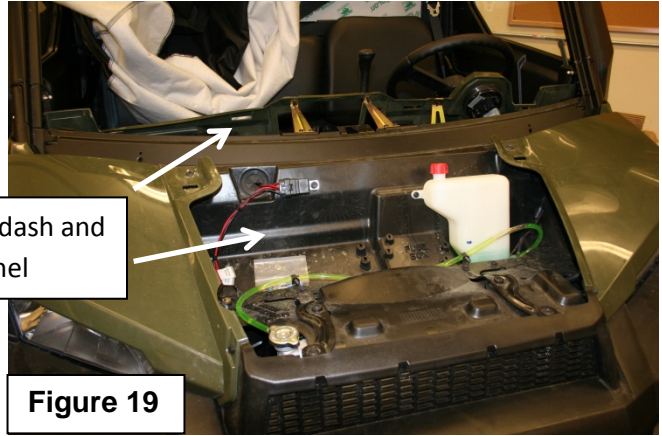

24. Remove floor panel. Figure 20.

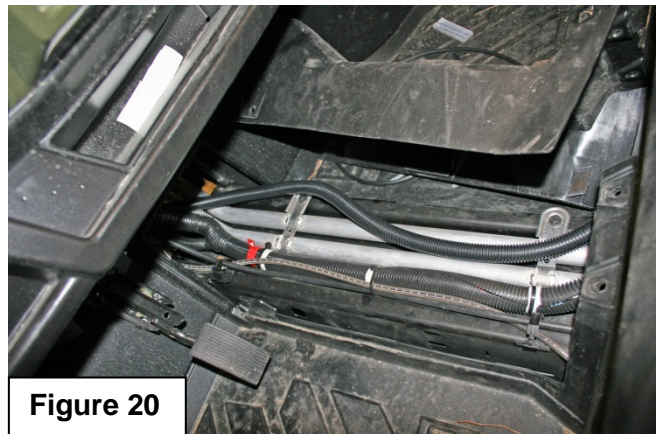

25. Feed section A of the wiring harness through the hole in the dash to the underside of the vehicle. (Feed through hole shown in Figure 21) Continue feeding wiring harness through the floor panel shown in Figure 20, ending in the battery compartment.

Feed wiring harness through hole

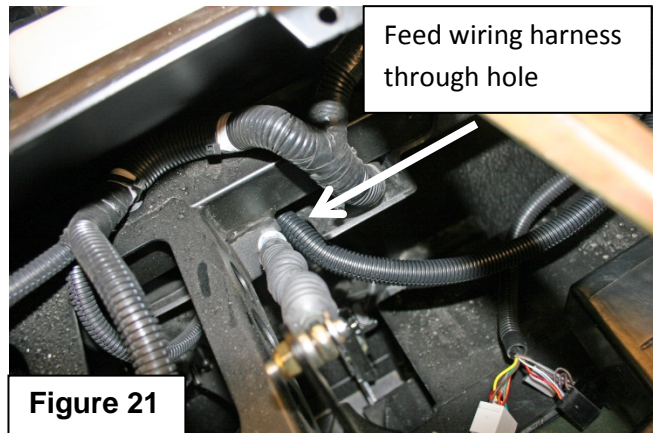

26. Remove grommet shown in Figure 22. Use a blade to score the lines on the grommet. Re-install the grommet. Feed section B of the wiring harness through the grommet. Attach the black wire (ground) to the screw on the right using a T25 driver. Attach the red wires to the location on the left.

27. Align relay with mounting location of your discretion. Drill through metal mount bracket and dash using a 5/16" drill bit. (Drill shallow to avoid hitting anything else) Mount relay using dart included in kit.

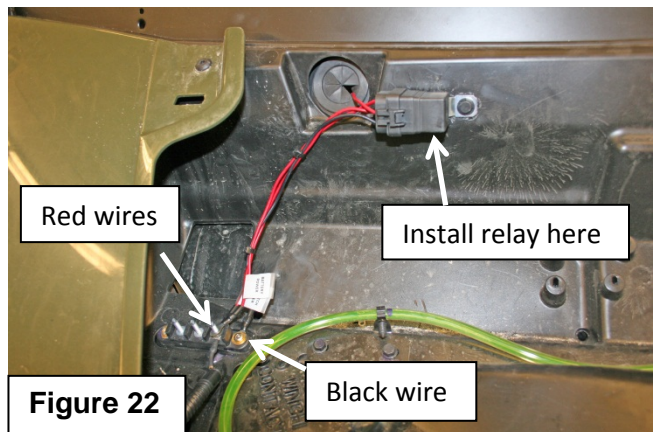



28. Remove knockouts in the dash to make room for the driver and passenger controls. Use a dremel tool to expand the hole size as necessary. Figure 23.
29. Install driver and passenger controls at the end of section C into holes from Step 28.



**Figure 23**

30. Install wires onto the bolt in the battery compartment as shown in Figure 24 using a 10mm socket.
31. Feed the short wire behind the passenger seat to connect to the passenger door.
32. Feed the long wire behind the driver seat to connect to the driver door.
33. Turn on the vehicle and test controls to ensure the wiring harness has been correctly installed.
34. Use the zip ties included in this kit to fasten the wiring harness to other wires/cables at the installer's discretion.
35. Re-install the foot panel, hood panel, dash panel, and passenger seat.

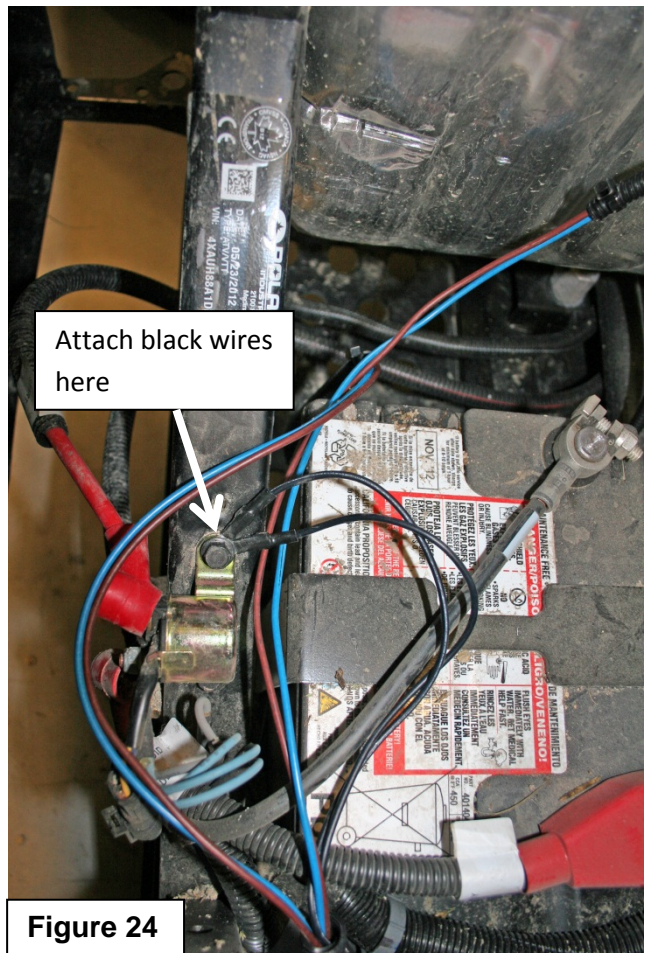

**Figure 24**