

# ACCENT LIGHT KIT



P/N 2884346

## APPLICATION

Verify accessory fitment at [www.polaris.com](http://www.polaris.com).

## BEFORE YOU BEGIN

Read these instructions and check to be sure all parts and tools are accounted for. Please retain these installation instructions for future reference and parts ordering information.

## KIT CONTENTS

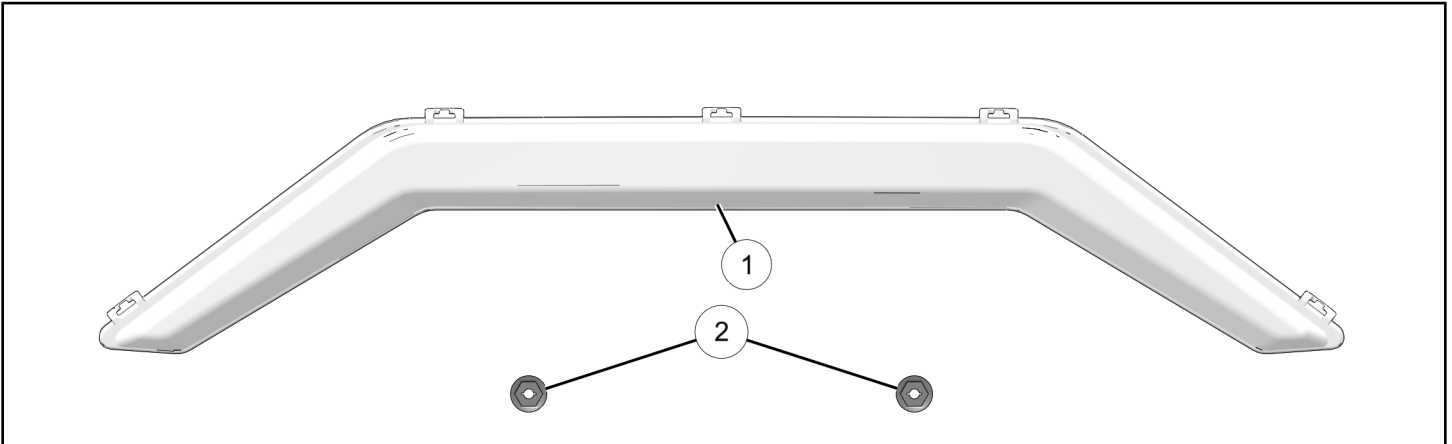

REF	QTY	PART DESCRIPTION	P/N AVAILABLE SEPARATELY
1	1	Assembly–Light, Accent, Front	2414544
2	4	Speed Nut–Washer, Head 1/4 in	7670054

## TOOLS REQUIRED

- Safety Glasses
- Socket Set, SAE
- Wrench Set, SAE

## IMPORTANT

Your Accent Light Kit is exclusively designed for your vehicle. Please read the installation instructions thoroughly before beginning. Installation is easier if the vehicle is clean and free of debris. For your safety, and to ensure a satisfactory installation, perform all installation steps correctly in the sequence shown.

## INSTALLATION INSTRUCTIONS

### VEHICLE PREPARATION

#### GENERAL

1. Shift vehicle transmission into PARK. Turn ignition switch to OFF position and remove key.

## GRILLE REMOVAL

1. Pull down on two tabs, located on top-edge of grille.

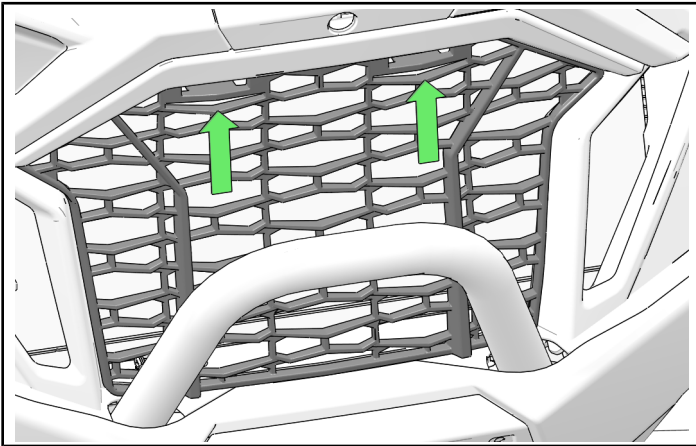

2. Tip grille forward and pull out until bottom tabs are clear of front fascia and bull bumper.

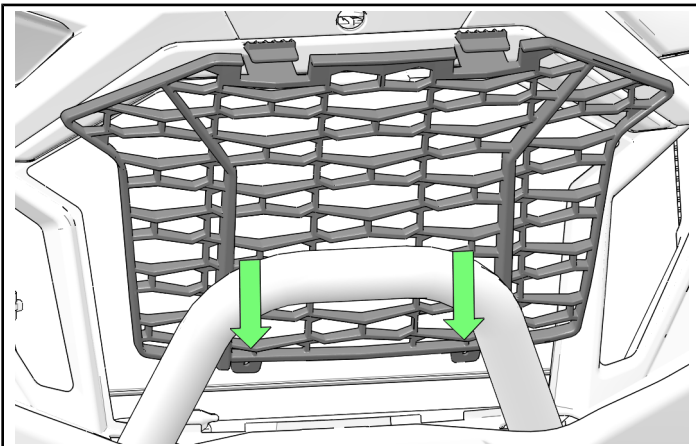

## ACCESSORY INSTALLATION

1. Remove and discard two speed nuts from rear of accent trim. Discard accent trim.

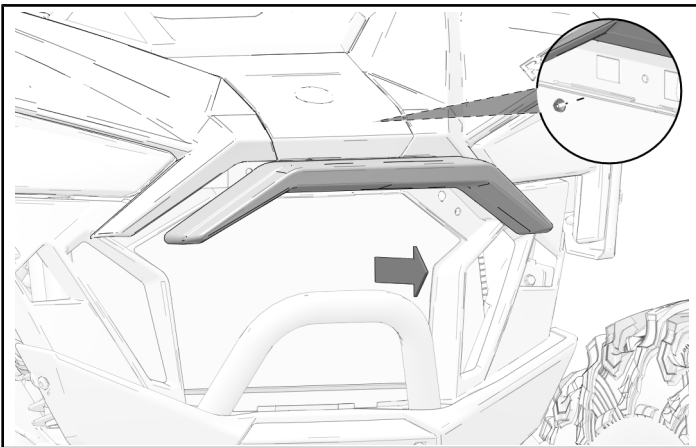

2. Locate electrical harness connector on vehicle.

3. Pass harness through front fascia opening and connect harness to accent light.

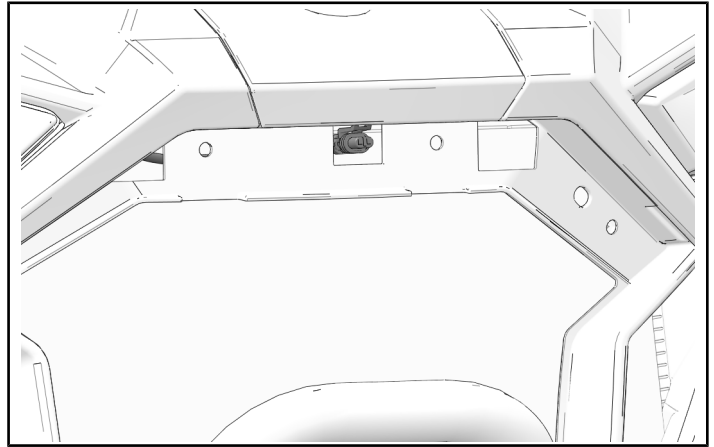

4. Align accent light ① with front fascia and secure with four speed nuts ②.

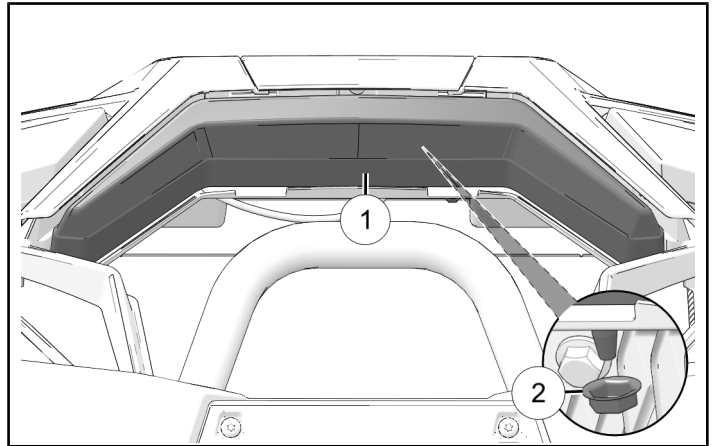

## VEHICLE REASSEMBLY

### GENERAL

1. Turn vehicle on and verify accent light operates properly before proceeding with vehicle reassembly procedures.

### GRILLE INSTALLATION

1. Tip bottom of grille into front fascia.

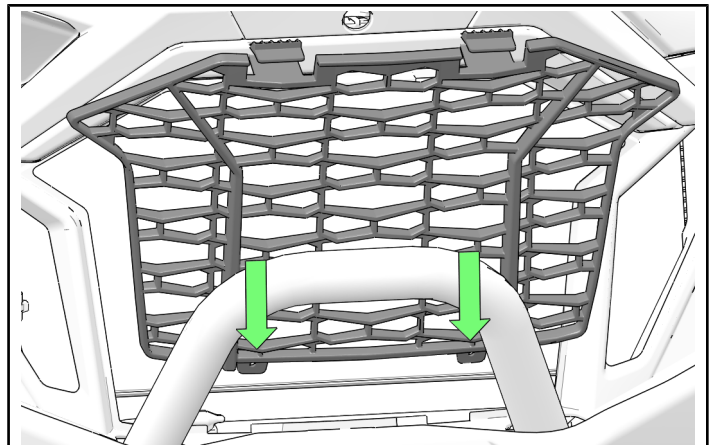

2. Push top of grille into front fascia until two tabs engage with fascia and are secure.

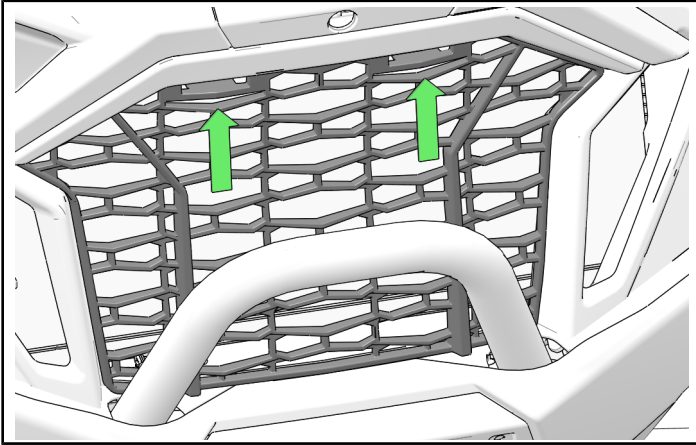

## FEEDBACK FORM

A feedback form has been created for the installer to provide any comments, questions or concerns about the installation instructions. The form is viewable on mobile devices by scanning the QR code or by clicking [HERE](#) if viewing on a PC.

