

For Maintenance and Safety

INDIAN RIDE COMMAND USER GUIDE



4.3" ROUND DISPLAY POWERED BY RIDE COMMAND



WARNING

Read, understand, and follow all of the instructions and safety precautions in this manual and on all product labels.

Failure to follow the safety precautions could result in serious injury or death.



WARNING

Operating, servicing, and maintaining a passenger vehicle or off-road vehicle can expose you to chemicals including engine exhaust, carbon monoxide, phthalates, and lead, which are known to the State of California to cause cancer and birth defects or other reproductive harm. To minimize exposure, avoid breathing exhaust, do not idle the engine except as necessary, service your vehicle in a well-ventilated area and wear gloves or wash your hands frequently when servicing your vehicle.

For more information go to www.P65Warnings.ca.gov/passenger-vehicle.



**User Guide for 4.3”
Round Display Powered by
RIDE COMMAND**

All information contained within this publication is based on the latest product information available at the time of publication. Product improvements or other changes may result in differences between this manual and the motorcycle. Depictions and/or procedures in this publication are intended for reference use only.

No liability can be accepted for omissions or inaccuracies. Indian Motorcycle Company reserves the right to make changes at any time, without notice and without incurring obligation to make the same or similar changes to motorcycles previously built. Any reprinting or reuse of the depictions and/or procedures contained within, whether whole or in part, is expressly prohibited.

Unless noted, trademarks are the property of Indian Motorcycle International, LLC

RIDE COMMAND® is a registered trademark of POLARIS Industries, INC. iPhone®, Apple®, App Store®, and Apple CarPlay® are registered trademarks of Apple Inc. Google Play® is a registered trademark of Google, LLC. Bluetooth® is a registered trademark of Bluetooth Sig, Inc. exFAT® is a registered trademark of Microsoft Corporation. FAT32® is a registered trademark of Microsoft Corporation. Schrader® is a registered trademark of SENSATA TECHNOLOGIES, INC. NIMBELINKSM is service trademark of NIMBELINK CORP. Motorcycle Safety Foundation® is a registered trademark of Motorcycle Safety Foundation. NGK® is a registered trademark of NGK Spark Plug Co. Ltd. BatteryMINDer® is a registered trademark of VDC Electronics. Inc. Marquardt® is a registered trademark of MARQUARDT GMBH CORPORATION FED REP GERMANY. LEGENDARY - Welshly Arms - No Place is Home.

© 2023 Indian Motorcycle International, LLC. Metzeler® and Cruisetec® are registered trademarks of Pirelli Tyre S. P.A. JCASE® is a registered trademark of Littelfuse, Inc.

CONGRATULATIONS!

Congratulations on your purchase of a new INDIAN MOTORCYCLE. You have joined an elite family of motorcycle riders who have acquired a celebrated piece of American history by choosing to own an INDIAN MOTORCYCLE.

Your new motorcycle is the end result of true dedication and craftsmanship by our engineering, design and assembly teams. It was designed and manufactured to meet our goal of providing you with a high quality motorcycle that you can ride trouble-free for many years to come. We hope you will take as much pride in riding your new motorcycle as our team did in building it for you.

We urge you to read this user's guide thoroughly. It contains information essential to safe riding and the proper use and maintenance of your motorcycle's Ride Command display.

Your authorized INDIAN MOTORCYCLE dealer knows your motorcycle best and should be consulted for service and assistance. Skilled technicians using advanced equipment and methods are best qualified to perform all major repairs and service your motorcycle may require.

INDIAN MOTORCYCLE comply with all federal, state and local safety and emission regulations for the area of intended sale.

CONGRATULATIONS!

The following signal words and symbols appear throughout this manual and on your vehicle. Your safety is involved when these words and symbols are used. Become familiar with their meanings before reading the manual.

 **DANGER**

DANGER indicates a hazardous situation which, if not avoided, **WILL** result in death or serious injury.

 **WARNING**

WARNING indicates a hazardous situation which, if not avoided, **COULD** result in death or serious injury.

 **CAUTION**

CAUTION indicates a hazardous situation which, if not avoided, **COULD** result in minor to moderate injury.

NOTICE

NOTICE provides key information by clarifying instructions.

IMPORTANT

IMPORTANT provides key reminders during disassembly, assembly, and inspection of components.

Introduction. **7**
 Reporting Safety Defects 13
Getting Started **15**
Instruments, Features and Controls **19**
Operation. **29**
Maintenance **31**

INTRODUCTION

WELCOME

Welcome to RIDE COMMAND for INDIAN MOTORCYCLE. This intuitive display gives you access to a variety of interactive features and access to your motorcycle's custom information.

For a safe and enjoyable riding experience with your new display, please read your vehicle's owner's manual and this user guide. If you need additional assistance with display operation or software updates, please see your authorized INDIAN MOTORCYCLE dealer or visit ridecommand.indianmotorcycle.com.

For the latest information about your INDIAN MOTORCYCLE display powered by RIDE COMMAND, including software updates, please visit ridecommand.indianmotorcycle.com.

⚠ WARNING

Do not enter information while operating your vehicle. Failure to pay attention to the operation of your vehicle could result in loss of control, injury, or death. You assume all risks associated with using this device. Read your user guide thoroughly and always drive with the latest maps and road data from ridecommand.indianmotorcycle.com/display.

OVERVIEW



NOTICE

Using the display for an extended period of time while the vehicle's engine is off can drain the battery.

INTRODUCTION

WARNING

Do not enter information while operating your vehicle. Failure to pay attention to operating your vehicle could result in loss of control, injury, or death. You assume all risks associated with using this device. Read your User Guide.

WARNING

Driving while distracted can result in loss of vehicle control, crash, and injury. We strongly recommend that you use extreme caution when using any device that may take your focus off the road. Your primary responsibility is the safe operation of your vehicle. We recommend against the use of any hand-held device while driving and encourage the use of voice-operated systems when possible. Make sure you are aware of all applicable local laws that may affect the use of electronic devices while driving.

Before riding with your new display, do the following:

- Read this entire manual.
- Familiarize yourself with the features and operations of the display while the vehicle is stationary.
- Download the INDIAN MOTORCYCLE app from the APPLE APP STORE® or Google Play® store and create your personalized account.
- Check <https://www.polaris.com/en-us/owners-manuals/> for the latest updates to the owner's manual.

DEVICE OPERATING REQUIREMENTS

Phone functionality is dependent on the capabilities of your cell phone.

NOTICE

Some cell phones or operating systems will not work as shown in this manual.

RADIO COMPLIANCE STATEMENTS

The following statements apply to radio components offered with this vehicle. These include but may not be limited to the touchscreen display.

USA RADIO COMPLIANCE

This device complies with part 15 of the FCC Rules. Operation is subject to the following two conditions: (1) This device may not cause harmful interference, and (2) this device must accept any interference received, including interference that may cause undesired operation.

This device complies with FCC RF radiation exposure limits for general population.

⚠ CAUTION

This equipment complies with part 15 of the Federal Communications Commission (FCC) rules.

These requirements are intended to provide reasonable protection against harmful interference in a residential installation. This equipment generates, uses and can radiate radio frequency energy and, if not installed and used in accordance with the instructions, may cause harmful interference to radio communications. However, there is no guarantee that interference will not occur in a particular installation.

If this equipment does cause harmful interference to radio or television reception, which can be determined by turning the equipment off and on, the user is encouraged to try to correct the interference by one or more of the following measures:

- Reorient or relocate the receiving antenna.
- Increase the separation between the equipment and receiver.
- Connect the equipment into an outlet on a circuit different from that to which the receiver is connected.
- Consult the dealer or an experienced radio/TV technician for help.

Changes or modifications to this equipment not expressly approved by the party responsible for compliance could void the user's authority to operate the equipment.

CANADA RADIO COMPLIANCE

This vehicle contains the following radio equipment or components that contain radio equipment:

COMPONENT ID	MANUFACTURER
Ride Command RC-3R Display	Polaris Industries Inc.

This device contains license-exempt transmitter(s)/receiver(s) that comply with Innovation, Science and Economic Development Canada's license-exempt RSS(s). Operation is subject to the following two conditions:

1. This device may not cause interference.
2. This device must accept any interference, including interference that may cause undesired operation of the device.

EUROPEAN UNION (EU) RADIO COMPLIANCE

Hereby, INDIAN MOTORCYCLE declares that the above radio equipment is in compliance with EU Directive 2014/53/EU.

The full text of the EU declaration of conformity is available at the following internet address:

<https://www.polaris.com/en-us/radio-conformity/>



FREQUENCY BAND (MHZ)
2402–2480

INTRODUCTION

REGULATORY INFORMATION

Viewing Regulatory Information on the Display:

1. Tap the POLARIS logo at the top of the screen or press the POLARIS North Star button beneath the screen.
2. In the bottom right-hand corner, tap **All Settings**.
3. Tap the **REGULATORY INFORMATION** button.

<p>CHINA CMIIT ID: 2023DJ8308</p>	<p>MOROCCO AGREE PAR L'ANRT MAROC Numéro d'agrément:: MR00034612ANRT2022 Date d'agrément:: 22/09/2022</p>
<p>SINGAPORE</p> <p>Complies with IMDA Standards N2883-23</p>	<p>SOUTH AFRICA</p> <p>TA 2022/2105 APPROVED</p>
<p>ARGENTINA</p>  <p>C-29653</p>	<p>PHILIPPINES NTC</p>  <p>Type Accepted ESD-RCE-2334745</p>

<p>SOUTH KOREA</p>  <p>Applicant Name: Polaris Industries Inc. Model Name: RC-3R Model Number: RC-3R Band-use: 2402 MHz - 2480 MHz Year of Manufacture: 2023 Manufacturer: Polaris Industries Inc. Certification Number: R-R-1PR-RC-3R</p> <p>V2V is not enabled for South Korea.</p>
<p>UNITED ARAB EMIRATES</p> 
<p>THAILAND</p> <p>เครื่องโทรคมนาคมและอุปกรณ์นี้มีความสอดคล้องตามมาตรฐานหรือข้อกำหนดทางเทคนิคของ กสทช. <i>Translation: This telecommunication equipment conforms to the technical standards or requirements of NBTC.</i></p>

PARAGUAY



CONATEL

NR: 2023-06-1-0438

Manufacturer: Polaris Industries

Brand Name: Polaris

Model Number: RC3R

Distributor: Asuncion Motor Sport SA

Address: Mayor Evacio Perincio Merlo 2501, Asunción 001401, Paraguay

Contact Name: Jose de Ayala jose.ayala@amssa.com.py

MEXICO



IFT: RCPPORC21-0988

“La operación de este equipo está sujeta a las siguientes dos condiciones: (1) es posible que este equipo o dispositivo no cause interferencia perjudicial y (2) este equipo o dispositivo debe aceptar cualquier interferencia, incluyendo la que pueda causar su operación no deseada”

Translation: Operation of this equipment is subject to the following two conditions: (1) it is possible that this equipment or device may not cause harmful interference and (2) this equipment or device must accept any interference, including interference that may cause undesired operation.

TAIWAN — BSMI



R3F976

RoHS

- 使用過度恐傷害視力。 (Rough Translation: Excessive use may damage eyesight.)
- 使用30分鐘請休息10分鐘。 (Rough Translation: Please rest for 10 minutes after using for 30 minutes)
- 未滿2歲幼兒不看螢幕，2歲以上每天看螢幕不要超過1小時。 (Rough Translation: Children under the age of 2 should not watch the screen, and children over the age of 2 should not watch the screen for more than 1 hour a day.)

設備名稱：3286919
Equipment name RC-3R
型號（型式）：
Type Designation

限用物質及其化學符號
Restricted substances and its chemical symbols

單元 Unit	限用物質及其化學符號 Restricted substances and its chemical symbols					
	鉛Lead (Pb)	汞 Mercury (Hg)	鎘 Cadmium (Cd)	六價鉻 Hexavalent chromium (Cr ⁺⁶)	多溴聯苯 Polybrominated biphenyls (PBB)	多溴二苯 醚 Polybrominated diphenyl ethers (PBDE)
Digital Assembly	○	○	○	○	○	○

INTRODUCTION

(contains the PCB, screen, and electrical components) 數字裝配 触控显示 (包含 PCB、屏 幕和電氣 元件)						
Lower Case 底子盒子	○	○	○	○	○	○
Cable 導線	-	○	○	○	○	○
Bezel 擋板	○	○	○	○	○	○
Screw 螺絲釘	○	○	○	○	○	○
<p>備考1. “超出0.1 wt %”及“超出0.01 wt %”係指限用物質之百分比含量超出百分比含量基準值。 Note 1: “Exceeding 0.1 wt %” and “exceeding 0.01 wt %” indicate that the percentage content of the restricted substance exceeds the reference percentage value of presence condition.</p> <p>備考2. “○”係指該項限用物質之百分比含量未超出百分比含量基準值。 Note 2: “○” indicates that the percentage content of the restricted substance does not exceed the percentage of reference value of presence.</p>						

備考3. “-”係指該項限用物質為排除項目。
 Note 3: The “-” indicates that the restricted substance corresponds to the exemption.

TAIWAN — NCC

CCAL23LP0480T7

取得審驗證明之低功率射頻器材，非經核准，公司、商號或使用者均不得擅自變更頻率、加大功率或變更原設計之特性及功能。低功率射頻器材之使用不得影響飛航安全及干擾合法通信；經發現有干擾現象時，應立即停用，並改善至無干擾時方得繼續使用。前述合法通信，指依電信管理法規定作業之無線電通信。低功率射頻器材須忍受合法通信或工業、科學及醫療用電波輻射性電機設備之干擾。

Rough Translation: For low-power radio frequency equipment that has obtained certification, companies, firms or users are not allowed to change the frequency, increase the power, or change the characteristics and functions of the original design without approval. The use of low-power radio-frequency equipment must not affect flight safety and interfere with legal communications; if any interference is found, it should be stopped immediately, and it can only be used after improvement to no interference. The aforementioned legal communication refers to radio communication operated in accordance with the provisions of the Telecommunications Management Act. Low-power radio frequency equipment must endure the interference of legal communication or industrial, scientific and medical radio wave radiation electrical equipment.)

SERVICE AND WARRANTY INFORMATION

Some procedures are beyond the scope of this manual. See your dealer to purchase an *INDIAN MOTORCYCLE Service Manual*. Some procedures provided in the service manual require specialized knowledge, equipment, and training. Be sure you have the required technical skills and tools that are needed before you attempt ANY service on your motorcycle. Please contact your authorized dealer before attempting any service work that is beyond your level of technical knowledge or experience, or if the work requires specialized equipment.

OPERATING MOTORCYCLE OUTSIDE THE U.S.A.

If you plan to operate your motorcycle in countries other than the USA and Canada:

- Service facilities or replacement parts may not be readily available.
- Unleaded gasoline may not be available. The use of leaded fuels will cause engine damage, damage to your emissions systems and voiding of your warranty.
- Gasoline may have a considerably lower octane rating. Improper fuel can cause engine damage.

REPORTING SAFETY DEFECTS

If you believe that your vehicle has a defect that could result in a crash or cause injury or death, you should immediately inform the National Highway Traffic Safety Administration (NHTSA) in addition to notifying INDIAN MOTORCYCLE in writing.

If NHTSA receives similar complaints, it may open an investigation, and if it finds that a safety defect exists in a group of vehicles, it may order a recall and remedy campaign. However, NHTSA cannot become involved in individual problems between you, your INDIAN MOTORCYCLE dealer or INDIAN MOTORCYCLE.

To contact NHTSA, or obtain other information about motor vehicle safety, you may either call the Vehicle Safety Hotline toll-free at 1-888-327-4236 (TTY: 1-800-424-9153), visit the NHTSA website at www.safercar.gov, or write to:

ADMINISTRATOR, NHTSA
1200 New Jersey Avenue, SE
West Building
Washington, DC 20590

REPORTING SAFETY DEFECTS (CANADA)

To report a safety defect to Transport Canada, you may either fill out an online defect complaint form at their website (English: <http://www.tc.gc.ca/recalls>, French: <http://www.tc.gc.ca/rappels>) or contact their Defect Investigations and Recalls Division by calling toll-free 1-800-333-0510 (Canada) or 819-994-3328 (Ottawa-Gatineau area / International).





GETTING STARTED OVERVIEW



- ① Touchscreen Buttons
- ② Indicator Lamps
- ③ Turn Signal Indicators





- ④ Current Gear
- ⑤ Speedometer
- ⑥ Icon Bar





RIDE COMMAND BUTTONS



BUTTON	FUNCTION
	Press the Screen Cycle button to toggle through available display screens.
	Press the Controls button to access vehicle and display settings.
	Press the App Tray button to access the Settings and Phone screens.
	Press the Back button to back out of menus screens.

GETTING STARTED

INDICATOR LAMPS

LAMP	INDICATES	CONDITION
	High Beam	The headlight switch is set to high beam. This indicator will flash if there is a problem with the low or high beam light.
	Low Battery Voltage	This lamp illuminates when battery voltage is low (or when voltage is above the normal range). Turn non-essential accessories off to conserve power. Make sure the charging system is operating properly.
	Engine Overheat	This lamp illuminates to indicate an overheated engine. If the indicator flashes, the overheating condition remains, and the system will automatically reduce engine power.
	Anti-Lock Brake System	The indicator remains on until the anti-lock system activates, which occurs when vehicle speed exceeds 6 mph (10 km/h). When the lamp is illuminated, the anti-lock brakes will not activate, but the conventional brake system will continue to operate normally.

LAMP	INDICATES	CONDITION
	Cruise Control Enabled	Before using the cruise control, read the safety and operation procedures.
	Cruise Control Engaged	Before using the cruise control, read the safety and operation procedures.
	Low Fuel	This lamp illuminates when approximately one gallon (3.8 liters) of fuel remains in the fuel tank.
	Neutral	The transmission is in neutral and the power switch is ON.
	Check Engine	<i>If this lamp illuminates while the engine is running, promptly contact an authorized dealer or another qualified person who can assist with diagnosis. If abnormal engine operation is detected the light will remain on as</i>

LAMP	INDICATES	CONDITION
		long as the fault condition exists. Retrieve the error codes for diagnosis. See the Error Codes section for details. This lamp is also known as a malfunction indicator lamp (MIL).
	Chassis Warning	If a fault condition is detected, the light will remain on as long as the condition exists. Retrieve the error codes for diagnosis. This lamp is also known as an Amber Warning Lamp (AWL).
	Sidestand Light	The sidestand light will turn on anytime the sidestand is down.

ICON BAR

The Icon Bar displays information, such as cell signal strength, current ride mode, and more.



- ① Headset Connection
- ② Cruise Control
- ③ Cell Signal Strength
- ④ Clock
- ⑤ Ride Mode

INSTRUMENTS, FEATURES AND CONTROLS

CHIEF HAND CONTROLS

MEDIA SWITCH

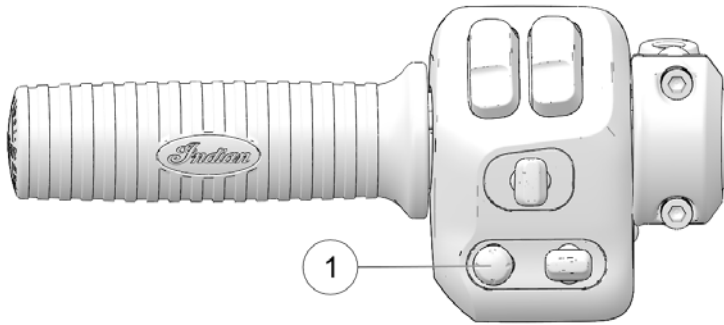

SELECT SWITCH

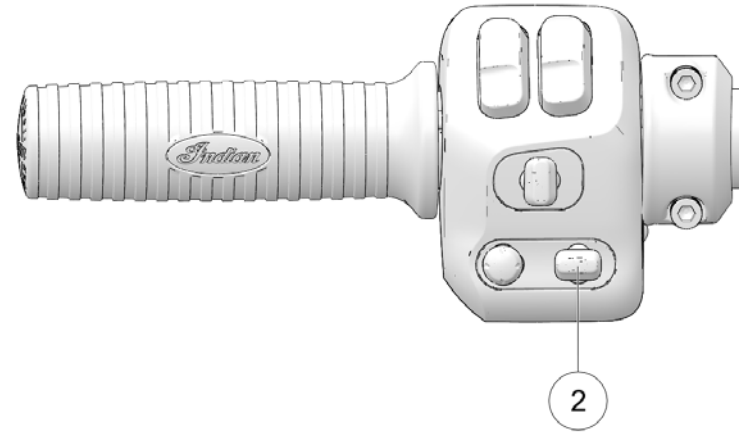

Use the 5-way media switch ① to do the following:

- Press center to mute
- Press up/down to increase/decrease volume.
- Press left/right to move to previous/next track.
- Long press to activate Push to Talk.

Use the 3-way select switch ② to do the following:

- Press up and down to navigate display screen.
- Press center to select.
- Press and hold to drop down badge panel.

TRIGGER SWITCHES

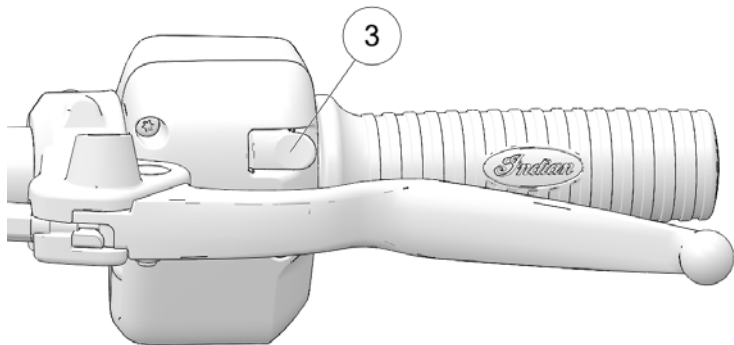

There are trigger switches located on the reverse side of both the right and left ③ switch cubes.

Use the trigger switches to do the following:

- Press the right trigger switch to confirm selection.
- Press the left trigger switch to back out of menu screens.

FTR / SCOUT HAND CONTROLS 5-WAY TOGGLE SWITCH

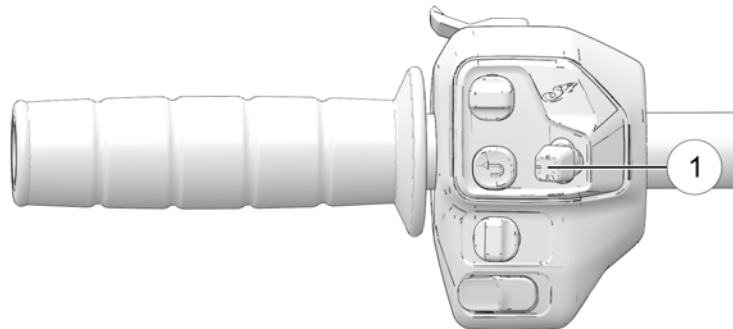

Use the 5-way toggle switch ① to do the following:

- Long press to show the App Tray
- Navigate through the menu gauge / menu screens
- Enter / Select
- Change the gauge style

Press and hold the 5-way toggle switch up / down / left or right to bring up the media control overlay. When the media overlay is visible on the screen, use the 5-way toggle to control feedback.

- Press left / right to navigate tracks
- Press up / down control the volume
- Press center to mute / unmute

TRIGGER SWITCH

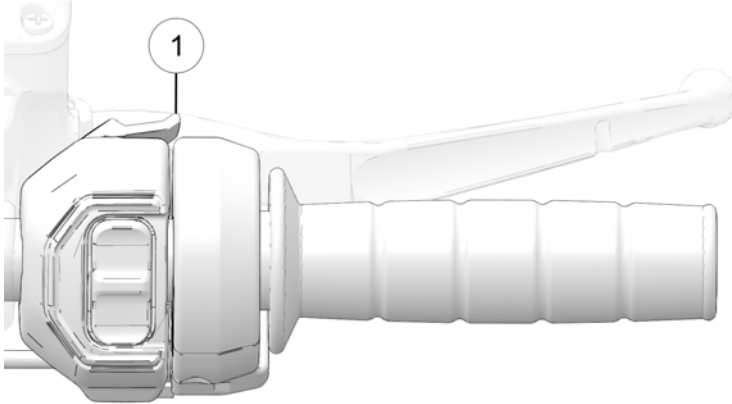

The trigger switch ① is located on the reverse side of the right switch cube and is used to toggle through the Ride Command display screens.

RIDE COMMAND RIDE MODES

You can choose between different ride modes based on your vehicle and its accessories to customize your riding style. Please reference your vehicle owners manual for applicable ride modes.



INSTRUMENTS, FEATURES AND CONTROLS

DISPLAY SCREEN

The Display Screen displays important ride data and vehicle information, such as vehicle speed, current gear, fuel level, and more.



- ① Speedometer
- ② Tachometer
- ③ Current Gear
- ④ Vehicle Direction
- ⑤ Ambient Temperature
- ⑥ Odometer
- ⑦ Fuel Level

SCREEN FUNCTIONS

Press the Screen Cycle button ①, or the trigger switch on the left hand control, to cycle through the available display screens.



DISPLAY SCREENS	FUNCTION
Gauge Screen	Displays important information, such as speedometer, tachometer, gear, vehicle direction, ambient temperature, odometer, and fuel level.
Bike Information	Displays bike information, such as ambient temperature, battery voltage, tire pressure, fuel economy, and fuel range.
Maps and Navigation	Provides access to maps and turn-by-turn navigation.
Ride Information	Displays ride information, such as ride time, distance, elevation, and trip odometer.
Controls	Select ride mode and change display brightness.
Audio	Select audio source and control audio playback.

DISPLAY SCREEN THEMES

There are two Display Screen themes to choose from, **Standard** and **Analog Sport**. The Display Screen themes can be changed in the settings menu.

Standard

The Standard theme resembles a classic analog dial-face, with a traditional speedometer design.



Analog Sport

For a slightly cleaner look, the Analog Sport theme displays the speedometer as a numeric value rather than a meter.



INSTRUMENTS, FEATURES AND CONTROLS

BIKE INFORMATION

The Bike Information screen displays important information about your vehicle, such as front and rear tire pressure (if equipped/installed), fuel economy, and more.



① Ambient Temperature

④ Battery Voltage

② Rear Tire Pressure

⑤ Front Tire Pressure

③ Fuel Economy

⑥ Fuel Range

MAPS AND NAVIGATION

The Maps and Navigation screen allows access to Ride Command's many navigation features. From the maps and navigations screen you can find directions, look up addresses, search for gas stations, and pinpoint other points of interest. Once selected, the display will provide turn-by-turn directions to your destination.



RIDE INFORMATION

The Ride Information screen displays important ride information, such as your current ride time, total distance traveled, and more.



- ① Ride Time
- ② Time Moving/Stopped
- ③ Reset Trip Odometer
- ④ More Information
- ⑤ Distance Traveled
- ⑥ Current Elevation
- ⑦ Select Trip Meter

CONTROLS

From the Controls screen you can select your ride mode and adjust the display brightness.



- ① Ride Mode
- ② Display Brightness
- ③ Close

INSTRUMENTS, FEATURES AND CONTROLS

MUSIC

The Music screen allows you to access music stored on your smart-phone or other music device. You can pair your device using Bluetooth®, or by connecting it to the display's USB port.



APP TRAY

Press the App Tray hard button ① to cycle through the available app screens.



SETTINGS

From the Settings Menu you can view important details about your vehicle and personalize your touchscreen display. The settings menu is comprised of four categories: Information, General, Time, and Vehicle. See page 29 for more information.

PHONE

If the Ride Command display is connected to a phone using Bluetooth®, the Phone screen will be available from the App Tray. From the phone screen you can make and answer calls, and view text messages.



BLUETOOTH® PAIRING

The INDIAN MOTORCYCLE Ride Command touchscreen display can be connected to a smart-phone and a headset simultaneously.

To pair a device, do the following:

1. From the Bluetooth® Devices settings screen, the Phone screen, or the Music screen, tap on the Add Device button to bring up the pairing prompt.
2. Put your Bluetooth® device into pairing mode.
3. Wait until both the device and display are found to avoid issues pairing.
4. Select the name of the device you want to pair from the touchscreen display to finish the pairing process.
5. Confirm pairing (if applicable). Depending on the device you are pairing to the display you may be prompted to confirm pairing.

CONNECTED SERVICES

Certain INDIAN MOTORCYCLE Ride Command equipped models include connected services, provided for a limited time starting on the date of purchase. The features include speed limit layer, real time traffic, weather, and enhanced destination search capabilities. Available features will vary based on geographic location. To check your connected service status and to renew, go to: <http://ridecommand.indianmotorcycle.com>.

OPERATION SETTINGS

From the Settings Menu you can view important details about your vehicle and personalize your touchscreen display.

The settings menu is comprised of four categories: Information, General, Time, and Vehicle.



INFORMATION

From the Information settings menu you can view the following:

- Vehicle Identification Number (VIN)
- Mileage

- Installed Software Version
- Oil Change Interval

GENERAL SETTINGS

From the General settings menu you can do the following:

- Themes (Day/Night/Auto)
- Manage Bluetooth® Devices
- Change the Language
- Set the Speed Units of Measure (MPH or KPH)
- Set the Temperature Units (F or C)
- Update Software

TIME

From the Time Settings you can do the following:

- Set the Time Format (12 hour or 24 hour)
- Enable GPS Time (automatically sets the time to the time zone you are currently in)
- Set Time (if GPS Time is not enabled)

NOTICE

The clock is sourced from the GPS chip and periodically requires GPS lock to function correctly.

OPERATION

NOTICE

Clock reading will be non-existent or inaccurate after disconnecting battery and will require a new GPS sync to function properly.

VEHICLE

From the Vehicle Settings you can do the following:

- Oil Life/ Service Reset
- Access Vehicle Diagnostics

MAINTENANCE

CARE AND MAINTENANCE

To clean the display shell, use a soft cloth with mild soap and water. Do not use harsh or abrasive cleaners. For best results, use a micro-fiber towel to clean the screen. Window cleaner or alcohol may also be used.

NOTICE

Immediately clean off any gasoline that splashes onto the display.

VEHICLE STORAGE

When preparing the vehicle for storage make sure the ignition switch is in the OFF position to prevent battery drain and diminished battery life.

SPEED LIMITATION

Various aspects of the display such as phone contacts and call logs may be unavailable while driving at high speeds.

UPDATE SOFTWARE

For the latest software for INDIAN MOTORCYCLE Ride Command, go to:
<https://ridecommand.indianmotorcycle.com>.

The display software can be updated by connecting a USB stick containing the latest software version to the USB port located on the bottom left of the display. The Update Software menu in Settings will list any available updates on the USB stick. Choose the correct version and wait for the update to complete before removing the USB stick. The touchscreen display will automatically restart when software is updated.

IMPORTANT

It is recommended to connect your bike to a trickle charger before updating software or maps. Refer to your Owner's Manual for the trickle charger location.

SOFTWARE UPDATES

For software update, INDIAN MOTORCYCLE recommends using a SanDisk® or similar USB flash drive with a minimum of 1GB in available memory, formatted using the exFAT® file system. For best results remove all files from the flash drive before starting the update process.

MAINTENANCE

MAP AND POINT OF INTEREST UPDATES

For Map and Point of Interest updates, a 32GB or larger USB drive is required (USB 3.0 drive is highly recommended). USB drive must be formatted to exFAT® before copying files onto it.

NOTICE

A USB 2.0 or USB 3.0 flash drive formatted to exFAT® is required to successfully perform an update. The display will not recognize flash drives that do not meet this requirement.

IMPORTANT

Do not remove power from the display during the update process.

OVER THE AIR UPDATES

NOTICE

Over the air updates are only available on models equipped with a cell modem.

If your model is equipped with a cell modem, the motorcycle will automatically download software updates from the cloud when the motorcycle is powered on and a cell modem connection is available. All downloads occur in the background and can be resumed if the connection is interrupted or if the motorcycle is turned off.

HOW TO INSTALL SOFTWARE

Once new software has been downloaded to your display, you will be prompted with a notification.

To install new software, do the following:

1. Navigate to the General Settings tab in the Settings menu.
2. Press the “Install” button.

NOTICE

The following conditions must be met for the installation to initiate: the battery voltage must be greater than 12.5 V, the wheel speed must be at 0 mph, and the RPMs must equal 0.

NOTICE

The display will restart after the installation has successfully completed.

NOTICE

Critical updates will be installed automatically. A notification will display once the update is complete.

3. After the update had been completed, release notes will be provided on the software update screen.

UPDATE MAPS

For the latest maps for Ride Command, go to <https://ridecommand.indianmotorcycle.com>.

NOTICE

The display will automatically restart after a software and map update.

NOTICE

For map updates, a 32GB or greater USB drive formatted to exFAT® is required.

USB PORT

The USB Port makes it easy to power devices, such as phones, audio sources, or GPS units, in addition to allowing you to stream music through the LCD display to your Bluetooth® headset. On models equipped with a INDIAN MOTORCYCLE Ride Command display, the USB port is also used to update the display software. For the latest software, go to <https://ridecommand.indianmotorcycle.com>.

IMPORTANT

Due to harsh riding environments, INDIAN MOTORCYCLE recommends using a USB device with retention features.

RIDE COMMAND+

Your vehicle may come equipped with RIDE COMMAND+ technology, which gives you access to your vehicle's custom information including Vehicle Health, Vehicle Locator and Issue Diagnostics (if equipped) along with a variety of features via the INDIAN MOTORCYCLE mobile app. You will need a cellular connection to view these features.

To learn more about RIDE COMMAND+, including equipped or compatible vehicles, specific features, and to access the RIDE COMMAND+ User Guide, visit ridecommand.indianmotorcycle.com or scan the QR code:



Disclaimer: RIDE COMMAND+ features vary by region.

A
 App Tray 26

B
 Bike Information 24
 Bluetooth® Pairing 27

C
 Canada Radio Compliance 9
 Care and Maintenance 31
 Controls 25

E
 European Union (EU) Radio
 Compliance 9

G
 Gauge Screen 22

H
 Hand Controls 19

I
 Indicator Lamps 16

M
 Maps and Navigation 24
 Music 26

O
 Operating Motorcycle Outside the U.
 S.A. 13
 Overview 7

R
 Regulatory Information 10
 Reporting Safety Defects 13
 Reporting Safety Defects (Canada) 13
 Ride Command 7
 Buttons 15
 Icon Bar 17
 Overview 15
 Update Software 31
 Ride Command Display
 Over the Air Updates 32
 RIDE COMMAND+ 33
 Ride Information 25

Ride Modes 21

S
 Safety Symbols 4
 Service Information 13
 Settings 29
 Signal Words 4
 Speed Limitation 31
 Switch
 5-Way Toggle 20
 SwitchTrigger Switch 21

U
 Update Maps 33
 USA Radio Compliance 8
 USB Port 33

V
 Vehicle Storage 31

W
 Warning Symbols 4
 Warranty Information 13

To locate your nearest dealer,
visit www.indianmotorcycle.com

INDIAN MOTORCYCLE

2100 Highway 55

Medina, MN 55340

Phone: 1-877-204-3697

French: 1-800-268-6334



Rev 01

Printed in U.S.A.