

# OWNER'S MANUAL

Express Cruisers



**RINKER**

SINCE 1945

## FUEL SYSTEMS

Boats manufactured for use in California for model year 2018 and after meet the California EVAP Emissions regulation for spark-ignition marine watercraft. Boats meeting this requirement will have the following label affixed near the helm.

### WARNING

Operating, servicing and maintaining a recreational marine vessel can expose you to chemicals including engine exhaust, carbon monoxide, phthalates and lead, which are known to the State of California to cause cancer and birth defects or other reproductive harm. To minimize exposure, avoid breathing exhaust, service your vessel in a well-ventilated area and wear gloves or wash your hands frequently when servicing this vessel. For more information go to: [www.P65warnings.ca.gov/marine](http://www.P65warnings.ca.gov/marine)

The fuel system in boats marketed in states other than California complies with U.S. EPA-mandated evaporative emission standards at time of manufacture using certified components.

## CALIFORNIA AIR RESOURCES BOARD (CARB)

Outboard, sterndrive and inboard powered boats sold in the state of California are equipped with special components and certified to meet stricter environmental standards and exhaust emissions. All boats sold in California since 2009 are required to meet Super-Ultra-Low (four-star) emissions.

## EXHAUST EMISSIONS



Sterndrive and inboard marine engine powered boats meeting CARB's exhaust emission standards are required to display the four-star label on the outside of the hull above the waterline. Outboard and personal watercraft marine engines may also comply with these standards.

### DANGER

Carbon monoxide (CO) can cause brain damage or death. Engine and generator exhaust contains odorless and colorless carbon monoxide gas. Carbon monoxide will be around the back of the boat when engines or generators are running. Signs of carbon monoxide poisoning include nausea, headache, dizziness, drowsiness and lack of consciousness. Get fresh air if anyone shows signs of carbon monoxide poisoning. See engine manufacturer's manual for information regarding carbon monoxide poisoning.

# TABLE OF CONTENTS

<b>Introduction</b> . . . . .	<b>1-1</b>
Congratulations . . . . .	1-1
About This Manual . . . . .	1-1
About Your New Boat. . . . .	1-2
Boat Terminology . . . . .	1-2
Hull Identification, Capacity and Safety Plates . . . . .	1-2
References and Contact Information . . . . .	1-5
Boat Information Form . . . . .	1-8
<b>Safety</b> . . . . .	<b>2-1</b>
Good Boating Practices . . . . .	2-1
Safety Decals and Statements . . . . .	2-4
Safety Decals . . . . .	2-4
Safety Statements . . . . .	2-4
Safety Precautions . . . . .	2-5
Carbon Monoxide (CO) . . . . .	2-9
Required Boating Safety Equipment and Regulations. . . . .	2-11
Fire Extinguisher . . . . .	2-13
Engine Emergency Stop Switch and Lanyard. . . . .	2-13
Life Jackets . . . . .	2-14
Visual Distress Signaling Devices . . . . .	2-18
Audible Signaling Devices . . . . .	2-19
Navigational Lights . . . . .	2-19
Unapproved Lighting. . . . .	2-20
Recommended Safety Equipment . . . . .	2-21
Very High Frequency (VHF) Radio. . . . .	2-23
Radar . . . . .	2-24
Radar Reflectors . . . . .	2-24
Global Maritime Distress and Safety System (GMDSS) . . . . .	2-24
VHF-DSC Radio . . . . .	2-25
Emergency Position Indicating Radio Beacons (EPIRBs). . . . .	2-28
Safety and Training . . . . .	2-28
Situational Awareness . . . . .	2-29
Driving Defensively . . . . .	2-29
Small Boats and Swimmers . . . . .	2-29



# TABLE OF CONTENTS

Knowing the Boat . . . . .	2-30
Special Needs Passengers . . . . .	2-30
Cruising Limitations . . . . .	2-31
Hazard Information . . . . .	2-32
Towing a Tender . . . . .	2-32
Water Sports . . . . .	2-33
Platform Dragging . . . . .	2-33
Water Sports Guidelines . . . . .	2-34
<b>Boating Regulations and Your Responsibilities . . . . .</b>	<b>3-1</b>
Boat Owner / Operator Responsibilities . . . . .	3-1
Safety . . . . .	3-1
Registration . . . . .	3-2
Insurance . . . . .	3-2
Reporting Accidents . . . . .	3-2
Boating Under the Influence . . . . .	3-3
Operator's License and Education . . . . .	3-3
Operation By Minors . . . . .	3-3
Emergency Assistance . . . . .	3-4
Negligent Operation . . . . .	3-4
Restricted Areas . . . . .	3-4
Security Zones . . . . .	3-4
Naval Vessel Protection Zones . . . . .	3-5
Commercial Shipping Safety Zones . . . . .	3-5
Bridges and Shipping Channels . . . . .	3-5
America's Waterway Watch . . . . .	3-5
Fishing . . . . .	3-5
Monofilament Fishing Line . . . . .	3-6
Marine Animals in Distress . . . . .	3-6
Wake . . . . .	3-6
Noise . . . . .	3-7
Speed . . . . .	3-7
Shallow Water Boat Stability . . . . .	3-7
Protecting the Environment . . . . .	3-7
Waste Management Plan (WMP) . . . . .	3-8
MARPOL Treaty . . . . .	3-8
Aquatic Invasive Species (AIS) . . . . .	3-9
Paints . . . . .	3-9

# TABLE OF CONTENTS



Cleaning Agents . . . . .	3-9
Exhaust Emissions . . . . .	3-10
Additional Proposition 65 Information . . . . .	3-10
<b>Emergencies . . . . .</b>	<b>4-1</b>
First Aid / Medical Emergencies . . . . .	4-1
Emergency Preparation Checklist . . . . .	4-1
Using Distress Signal Devices and Calling for Help . . . . .	4-1
Requesting Assistance (Non-Distress Call) . . . . .	4-2
Law of Salvage . . . . .	4-3
Fire and Explosion . . . . .	4-3
Man Overboard (MOB) . . . . .	4-4
Capsizing and Flooding . . . . .	4-5
Running Aground . . . . .	4-6
Dangerous Weather . . . . .	4-6
Engine or Boat System Failure . . . . .	4-6
Accidents, Collisions and Giving Assistance . . . . .	4-7
Towing on the Water . . . . .	4-7
Hurricane and Severe Weather Preparedness . . . . .	4-8
Protecting the Boat from Theft . . . . .	4-9
<b>Operating in Hazardous Conditions . . . . .</b>	<b>5-1</b>
Severe Weather . . . . .	5-1
Storm Conditions . . . . .	5-1
Fog Conditions . . . . .	5-2
Reduced Visibility . . . . .	5-2
Cold Weather and Cold or Frozen Water Conditions . . . . .	5-2
Water Hazards . . . . .	5-2
Aquatic Vegetation/Weeds . . . . .	5-3
Dams and Spillways . . . . .	5-3
Shallow Water Operation . . . . .	5-3
Markers, Warnings and Advisories . . . . .	5-4
Boat Flags . . . . .	5-4
Harbor Flags and Indicators . . . . .	5-5
<b>Navigation Rules and Aids . . . . .</b>	<b>6-1</b>
Navigation Rules . . . . .	6-1
Right-of-Way . . . . .	6-2



# TABLE OF CONTENTS

The General Prudential Rule . . . . .	6-2
Navigational Lights and Night Operation . . . . .	6-3
Audible Signals . . . . .	6-3
Overtaking / Passing . . . . .	6-4
Meeting Head-On . . . . .	6-5
Crossing . . . . .	6-6
Navigation Locks . . . . .	6-7
Aids to Navigation . . . . .	6-7
Buoys . . . . .	6-8
Mooring Buoys . . . . .	6-9
Daymarks / Dayboards . . . . .	6-9
Lights and Lighted Structures . . . . .	6-9
Markers . . . . .	6-11
<b>Operating the Boat . . . . .</b>	<b>7-1</b>
Before Getting Underway . . . . .	7-1
Safety Equipment . . . . .	7-1
Float Plan . . . . .	7-1
Considerations for Longer Voyages . . . . .	7-2
Synchronizing GPS Datum with Chart Datum . . . . .	7-2
Pre-Departure Safety Checklist . . . . .	7-3
Boarding . . . . .	7-4
Boat Loading . . . . .	7-4
Fueling . . . . .	7-5
Fuel Management . . . . .	7-5
Fuel Suppliers . . . . .	7-5
Static Electricity and the Fuel System . . . . .	7-6
Fuel (Gasoline) . . . . .	7-6
Before Refueling . . . . .	7-7
Fueling . . . . .	7-8
Refueling Built-In Fuel Tanks . . . . .	7-8
After Refueling . . . . .	7-8
Getting Underway . . . . .	7-9
Starting . . . . .	7-9
Steering . . . . .	7-10
Stopping . . . . .	7-13
Shifting . . . . .	7-14
Accelerating and Running Underway . . . . .	7-14



Checks During and After Operation . . . . .	7-16
Trim Tabs . . . . .	7-16
Power Trim and Tilt . . . . .	7-18
Power Trim Operation . . . . .	7-19
Docking . . . . .	7-21
Mooring . . . . .	7-23
Anchors and Anchoring . . . . .	7-23
Windlass . . . . .	7-25
Chain Counter . . . . .	7-26
Lines and Knots . . . . .	7-27
<b>Trailering and Launching . . . . .</b>	<b>8-1</b>
Legal Considerations . . . . .	8-1
Trailer Classification . . . . .	8-1
Trailer Type . . . . .	8-1
Trailer Gross Vehicle Weight Rating . . . . .	8-2
Towing Vehicle . . . . .	8-2
Vehicle Towing Hitch . . . . .	8-2
Hitch Ball and Trailer Coupler . . . . .	8-3
Safety Chains . . . . .	8-4
Trailer Brakes . . . . .	8-5
5-Pin Wiring Connector . . . . .	8-5
Trailering Guidelines . . . . .	8-6
Backing Up . . . . .	8-9
Launching . . . . .	8-9
Loading Guidelines . . . . .	8-11
Reporting Safety Defects . . . . .	8-12
<b>Boat Features and Options . . . . .</b>	<b>9-1</b>
Fuel System . . . . .	9-1
Engine Exhaust System . . . . .	9-2
Engine Lubrication System . . . . .	9-2
Engine Cooling System . . . . .	9-2
Electrical System . . . . .	9-3
DC System . . . . .	9-3
Automatic Charging Relay (ACR) . . . . .	9-5
AC System . . . . .	9-5
Shore Power . . . . .	9-8
Generator . . . . .	9-11



## TABLE OF CONTENTS

Electronic Leakage Circuit Interrupter (ELCI) . . .	9-12
Inverter/Charger . . . . .	9-14
Ground Fault Circuit Interrupters . . . . .	9-14
Shift and Throttle Controls. . . . .	9-16
Single-Lever Controls - Single or Twin Engine. . . . .	9-16
Dual-Lever Controls - Single or Multiple Engine. . . . .	9-17
Control Operation Guidelines . . . . .	9-18
Electronic Steering System . . . . .	9-18
Propellers. . . . .	9-19
Propeller Selection and Replacement Guidelines . . . . .	9-20
Dual-Prop Drives . . . . .	9-21
Display Panels . . . . .	9-21
Boat Monitoring Systems . . . . .	9-22
Electronic Steering System . . . . .	9-23
Electronic Propulsion Controls . . . . .	9-23
Stabilizer . . . . .	9-24
Bow Thrusters . . . . .	9-24
Joystick Controls . . . . .	9-24
Automatic Trim . . . . .	9-25
Digital Switches . . . . .	9-25
Typical Digital Switching Controls . . . . .	9-25
Remote Operation . . . . .	9-26
NMEA 2K Network. . . . .	9-27
Gauges / Instruments . . . . .	9-27
Multi-Gauges . . . . .	9-28
Tachometer. . . . .	9-28
Speedometer . . . . .	9-28
Fuel Level Gauge . . . . .	9-29
Engine Water Pressure Gauge . . . . .	9-29
Power Trim / Tilt Gauge . . . . .	9-29
Voltmeter . . . . .	9-30
Ammeter . . . . .	9-30
Engine Water Temperature Gauge . . . . .	9-30
Engine Oil Pressure Gauge. . . . .	9-31





Engine Synchronization Gauge (Dual Engine Applications) . . . . .	9-31
Engine Hour Meter . . . . .	9-31
Water Depth Gauge . . . . .	9-32
Compass . . . . .	9-32
Engine Warning Alarm System . . . . .	9-32
Gasoline Fume Detector Indicator . . . . .	9-32
Smoke Detector . . . . .	9-33
Helm and Control Switches . . . . .	9-33
Ignition Switch . . . . .	9-33
Blower Switch . . . . .	9-33
Battery Switch . . . . .	9-34
Engine Emergency Stop Switch and Lanyard . . . . .	9-35
Neutral Start Safety Switch (Start-in-Gear Prevention) . . . . .	9-36
Horn Switch . . . . .	9-36
Blower Switch . . . . .	9-36
Boarding and Courtesy Light Switches . . . . .	9-36
Power Trim / Tilt Switch . . . . .	9-36
Trim Tab Switch . . . . .	9-37
Fuel Gauge Switch . . . . .	9-37
Windshield Wiper Switch . . . . .	9-37
Navigation Lights Switch . . . . .	9-37
Bilge Pump Switch . . . . .	9-37
Bilge Pump System . . . . .	9-38
Boat Ventilation System . . . . .	9-38
Automatic Fire Extinguishing System . . . . .	9-39
Freshwater System . . . . .	9-39
Livewells . . . . .	9-42
Raw Water System . . . . .	9-43
Head and Waste Containment System . . . . .	9-45
Fuel-Burning Appliances . . . . .	9-48
Liquefied Petroleum Gas (LPG) Appliances . . . . .	9-49
Symbols . . . . .	9-51
<b>General Care and Maintenance . . . . .</b>	<b>10-1</b>
Engine . . . . .	10-1
Fuel System . . . . .	10-1



# TABLE OF CONTENTS

Electrical System . . . . .	10-2
Batteries . . . . .	10-2
Circuit Breakers and Fuses . . . . .	10-4
Galvanic Corrosion . . . . .	10-6
Saltwater Corrosion . . . . .	10-6
Sacrificial Anodes . . . . .	10-7
Steering System . . . . .	10-8
Corrosion Protection . . . . .	10-10
Hardware, Fasteners and Fittings . . . . .	10-10
Stainless Steel and Chrome Hardware . . . . .	10-10
Aluminum Hardware . . . . .	10-10
General Maintenance and Cleaning . . . . .	10-11
Marine Growth . . . . .	10-11
Cleaning . . . . .	10-11
Hull . . . . .	10-12
Upholstery . . . . .	10-12
Interior Fabric . . . . .	10-13
Canvas Covers and Bimini Tops . . . . .	10-13
Carpet . . . . .	10-14
Windshield . . . . .	10-14
Window Channels . . . . .	10-14
Teak . . . . .	10-15
Bilge . . . . .	10-16
Bilge Pump . . . . .	10-16
Detectors . . . . .	10-16
Trim Tabs . . . . .	10-16
Alcohol Stoves . . . . .	10-17
Raw Water System . . . . .	10-17
Freshwater System . . . . .	10-17
Head and Waste Containment System . . . . .	10-18
Safety Equipment . . . . .	10-19
General Boating Equipment . . . . .	10-19
Trailer . . . . .	10-20
<b>Winterization and Storage . . . . .</b>	<b>11-1</b>
Winterization and Storage Preparation . . . . .	11-1
Storing on a Cradle or Blocks . . . . .	11-2
Storing on a Trailer . . . . .	11-3

# TABLE OF CONTENTS



Recommissioning After Storage . . . . .	11-3
Preseason Electronics Checklist . . . . .	11-5
Lifting . . . . .	11-6
<b>Troubleshooting . . . . .</b>	<b>12-1</b>
<b>Glossary of Nautical Terms . . . . .</b>	<b>13-1</b>
<b>Index . . . . .</b>	<b>I-1</b>



# TABLE OF CONTENTS

This Page Intentionally Left Blank

# Section 1

## INTRODUCTION

### CONGRATULATIONS

Congratulations and welcome aboard! To ensure each boating experience is a safe and enjoyable one, please read all the literature provided with your newly purchased boat carefully before operating the boat or any equipment.

Please keep this manual on board for future reference and pass all information along to the new owner if you ever decide to sell the boat.

### ABOUT THIS MANUAL

This manual has been written as a general guide to safe operating practices, boating regulations and maintenance techniques for recreational boating. If this is your first time owning or operating a boat, it is recommended that you contact the boat dealer or local boating agency to find out how to enroll in a boater safety course prior to operating the boat.

This manual is not intended to be used as a replacement for specific information and procedures covered in manuals provided by the manufacturer of the engine, accessories and other major equipment.

Because we are constantly working toward product improvement, this manual is intended to be a general guide only. The illustrations used in this manual may not match the equipment on the boat; they are intended only as general reference views.



## ABOUT YOUR NEW BOAT

### BOAT TERMINOLOGY

It is important that you understand, learn and use appropriate and common nautical terminology while boating to ensure operator safety and the safety of others.

See the Glossary of Nautical Terms section of this manual for additional boating terminology.

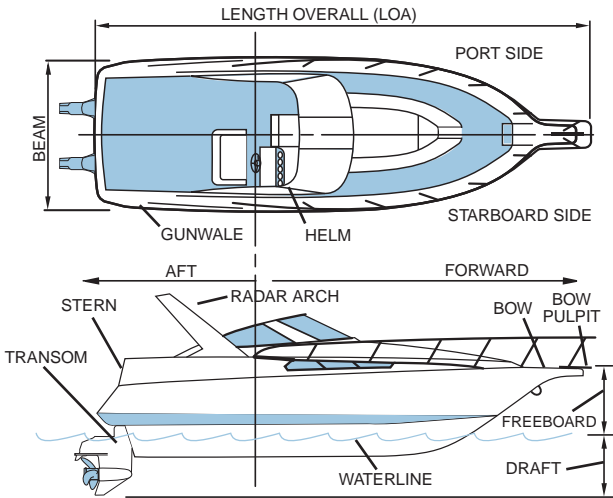

KC-0002-A

## HULL IDENTIFICATION, CAPACITY AND SAFETY PLATES

### Hull Identification Number

The hull identification number (HIN) is usually located near the upper starboard corner of the transom on the outside of the boat. In some instances, the HIN may be located in an alternate location as determined by the manufacturer (e.g., a pontoon HIN may be located on the aft crossmember approximately 1 foot (0.3 meters) from the starboard hull attachment). The HIN must be clearly visible and may not be removed, altered or tampered with in any way as regulated by federal law.



In case of collision, theft or damage, report these numbers to the local authorities, the insurance agent and the dealer.

Safeguard information about the boat by recording the HIN and model of the boat, and model and serial numbers of the engine and accessories on the Boat Information Form in this manual.

### **U.S. Coast Guard Safety Standards Compliance Plate**

All power boats less than 20 feet (6 meters) must have a manufacturer's compliance plate clearly indicating that the boat is in compliance with the U.S. Coast Guard (USCG) safety standards and the effective date of the compliance. The compliance plate may be combined onto one plate showing both the capacity plate and compliance information by the manufacturer.

As a division of the U.S. Department of Homeland Security, the USCG is the ultimate authority on U.S. waters. The USCG has the right to board any boat for any reason at any time. Failure to obey an order from the USCG can result in a fine, confiscation, imprisonment and even being fired upon in certain areas or conditions.

### **Certification Standards**

The boat was built to meet federal USCG requirements and *may* be certified to more stringent American Boat & Yacht Council (ABYC) standards for the fuel, electrical, ventilation, flotation, horn, identification, capacity, placards and labels, powering, start-in-gear protection, navigation lights, backfire flame control and in most cases, fire extinguishers.

The boat owner is responsible for other USCG-required safety items, which can vary depending on the size of the boat as follows:

- Fire Extinguishers
- Life Jackets
- Visual Distress Signals
- Navigation Rules on board (Boats 39 feet 5 inches (12 meters) in length overall (LOA) and greater
- Bell (Boats greater than 65 feet [20 meters] in length)

The boat manufacturer or dealer may provide some required safety items. Your boat *may not* be certified to ABYC standards; check the capacity plate for more information.



## INTRODUCTION

The person/load capacity is determined by the USCG. The capacity plate is usually located within clear visibility of the boat operator or helm area. The capacity plate indicates limits for loading the boat, which are enforceable by law. Never exceed the “U.S. Coast Guard Maximum Capacities” indicated on the capacity plate.

Boats in the National Marine Manufacturers Association (NMMA) Certification program up to 26 feet (7.9 meters), or a pontoon boat of any length, are certified to ABYC standards, have the USCG maximum rated load capacity on the certification plate and may contain EPA and/or CARB emission information. Do not exceed maximum person or weight capacities.



KCB-0008

### Boat Certification

Boats 26 feet (7.9 meters) and greater equipped with this placard are certified by the NMMA for compliance with NMMA and USCG safety standards.



KCB-0050





### Upper Deck Capacity Limit

Boats equipped with an upper deck, such as a flybridge or sun lounge, can experience stability issues if too much weight is placed on the upper deck. Weight on the upper deck raises the center of gravity, which makes the boat less stable and more likely to capsize under certain sea conditions.

Boats certified by the National Marine Manufacturers Association (NMMA) to American Boat & Yacht Council (ABYC) standards will have a plate on the upper deck stating the maximum weight capacity allowed on the upper which is usually less than the boat's maximum capacity of people and/or weight. Boats without a plate on the upper deck stating the maximum weight capacity should be limited to no more than 30% of the boat's maximum capacity of people and/or weight. Weight should always be distributed evenly front-to-back and side-to-side.

## REFERENCES AND CONTACT INFORMATION

Use the following list of publications and organizations for reference and contact information concerning safe boating, navigational rules and other boating topics.

### Publications

- Bottomley, Tom. *Boatman's Handbook*. Hearst Marine Book. Morrow
- Brotherton, Miner. *Twelve Volt Bible*. Seven Seas
- Calder, Nigel. *Boatowner's Mechanical and Electrical Manual*. McGraw-Hill Education
- Chapman, Charles F. and Maloney, E.S. *Chapman's Piloting, Seamanship and Small Boat Handling*. Hearst Marine Book. Morrow
- Hinz, Earl. *The Complete Book of Anchoring and Mooring*. Cornell Maritime Press
- National Fire Protection Association. *NFPA 302 Fire Protection Standard for Pleasure and Commercial Motor Craft*. National Fire Protection Association
- United States Coast Guard. *Navigational Rules for U.S. Waterways*. Visit <https://www.navcen.uscg.gov/> to view or download this publication.
- United States Coast Guard Auxiliary. *Boating Skills and Seamanship Thirteenth Edition*. United States Coast Guard
- Whiting, John and Bottomley, Tom. *Chapman's Log and Owner's Manual*. Hearst Marine Book

**Organizations*****American Boat & Yacht Council***

Boat building standards.

<http://abycinc.org>

***American Red Cross***

A resource for first aid training, emergency supplies and preparedness.

<http://www.redcross.org> or consult the local telephone directory

***Boat Owners Association of The United States***

Organization of recreational boaters offering marine services, education and protecting boater's rights.

<http://www.boatus.com/>

***BoatU.S. Foundation for Boating Safety Hotline***

Training and education outreach directly to boaters.

<http://www.boatus.org/>

Phone: 800-245-2628

***National Association of State Boating Law Administrators***

Boat safety training and education resources.

<http://www.nasbla.org>

***National Marine Manufacturers Association***

Boat, marine engine and accessory manufacturer trade association.

<http://www.nmma.org>

***National Oceanic and Atmospheric Administration's National Weather Service***

Nautical charting, weather, fishery, ocean and climate resources.

<http://www.noaa.gov>

***National Safe Boating Council, Inc.***

<http://www.safeboatingcouncil.org>

***Sea Tow Services International, Inc.***

Organization of recreational boaters offering in-water services, education and emergency assistance.

<http://www.seatow.com>

Toll free: 800-473-2869

***U.S. Coast Guard***

<http://www.uscgboating.org> (To contact the U.S. Coast Guard for an emergency while on the water, always use the onboard VHF-FM radio channel 16. Use cell phones only as a secondary means of communication. Call 9-1-1 to reach rescue personnel.)

***U.S. Coast Guard Auxiliary***

Information on boating safety classes and vessel safety checks.  
<http://nws.cgaux.org>; Phone: 877-875-6296

***U.S. Coast Guard Navigation Center (NAVCEN)***

USCG navigation information.  
<https://www.navcen.uscg.gov>

***U.S. Coast Guard Office of Boating Safety***

USCG resources for recreational boaters.  
<http://www.uscgboating.org>

***U.S. Coast Guard's America's Waterway Watch Program***

<http://www.americaswaterwaywatch.uscg.mil> (A program for recreational boaters to assist the U.S. Department of Homeland Security in reporting suspicious activity on U.S. waterways); Phone: 877-249-2824

***U.S. Government Publishing Office***

<http://www.gpo.gov>  
(For information and documentation on FCC rules and regulations and Skippers Course information, and other government, marine and nautical related documents)

***U.S. Power Squadrons***

Boating courses and knowledge resources.  
<http://www.usps.org>; Phone: 888-367-8777



## BOAT INFORMATION FORM

BOAT			
<b>Boat Manufacturer:</b>			
<b>Hull Colors:</b>			
<b>Weight:</b>			
<b>Length:</b>			
<b>Draft:</b>			
<b>Beam:</b>			
<b>Vertical Clearance:</b>			
<b>Dealer:</b>			
<b>Dealer Representative:</b>			
<b>Dealer Phone:</b>			
<b>Boat Model:</b>			
<b>Hull ID Number (HIN):</b>			
<b>Registration Number:</b>			
<b>Registration State:</b>			
<b>Purchase Date:</b>			
<b>Delivery Date:</b>			
<b>Warranty Expiration Date:</b>			
<b>Manufacturer Representative:</b>			
<b>Manufacturer Phone:</b>			
ENGINE, DRIVE AND PROPELLER			
<b>Engine Make:</b>			
<b>Engine Model Number</b>	<b>Port:</b>	<b>Engine Serial Number</b>	<b>Port:</b>
	<b>Stbd:</b>		<b>Stbd:</b>
	<b>Center:</b>		<b>Center:</b>
<b>Drive Make:</b>			
<b>Drive Model Number</b>	<b>Port:</b>	<b>Drive Serial Number</b>	<b>Port:</b>
	<b>Stbd:</b>		<b>Stbd:</b>
	<b>Center:</b>		<b>Center:</b>
<b>Propellers</b>	<b>Make:</b>		
	<b>Type:</b>		
	<b>Size:</b>		
	<b>Material:</b>		
	<b>Part Number:</b>		



<b>SYSTEMS</b>			
<b>Fuel Filter Part Number:</b>			
<b>Battery Make:</b>			
<b>Battery Size:</b>			
<b>TRAILER</b>			
<b>Trailer</b>	<b>Make:</b>		
	<b>Model Number:</b>		
	<b>Serial Number:</b>		
	<b>GVWR:</b>		
	<b>Tire Size:</b>		
<b>ACCESSORIES</b>			
<b>Fuel Tank Capacity:</b>		<b>Battery Make:</b>	
<b>Fuel Filter Part Number:</b>		<b>Battery Size:</b>	
<b>Ignition Key Number:</b>		<b>Freshwater Tank Capacity:</b>	
<b>Cabin Key Number:</b>		<b>Waste Holding Tank Capacity:</b>	
<b>Other Key Number:</b>			
<b>Generator</b>	<b>Make:</b>		
	<b>Model Number:</b>		
	<b>Serial Number:</b>		
<b>Marine Radio</b>		<b>Make:</b>	
		<b>Model Number:</b>	
		<b>Serial Number:</b>	



SECTION

# 1

## INTRODUCTION

This Page Intentionally Left Blank

# Section 2

## SAFETY

The popularity of boating and other water sports has undergone an explosion of growth in the past few years, making safety an important issue for everyone who shares in the use of the waterways.



### **WARNING**

***Operation Hazard: Read and understand this Basic Boating and Safety Manual, the Engine Operator's Manual and all manufacturer-supplied information regarding the operation of equipment. The boat operator must understand all safety information responsibilities, regulations, controls and operating instructions before attempting to operate the boat. Improper operation could result in death or serious injury.***

The safety content and precautions listed in this manual and on the boat are not all-inclusive. If a procedure, method, tool or part is not specifically recommended, the operator must feel confident that it is safe for them and others, and that the boat will not be damaged or become unsafe as a result of the operator's decision.

**REMEMBER – ALWAYS ASSESS EACH SITUATION AND USE SOUND JUDGMENT!**

The boat operator is responsible for their own safety, as well as that of passengers and other boaters.

## **GOOD BOATING PRACTICES**

Boating-related accidents are generally caused by the operator's failure to follow basic safety rules or written precautions. Most accidents can be avoided if the operator is completely familiar with the boat, its operation and the navigational rules of the road and can recognize potentially hazardous situations.

In addition to everyday safety, failure to observe safety recommendations may result in severe personal injury or death to the operator or to others. Use caution and sound judgment when operating the boat. Do not take unnecessary chances! Failure to adhere to these warnings could result in death or severe injury to the operator and/or others.



Read this entire manual and be aware of other specific safety guidelines not listed in this manual. Seek additional safety information from the USCG and state and local authorities. In addition to specific safety statements noted in this manual, a general list of safety guidelines and recommendations is listed below:

- The boat must comply with USCG safety equipment regulations.
- Before each outing, check all safety equipment such as fire extinguishers, life jackets, flares, distress flags, flashlights and engine emergency stop switch. Make sure they are operable, in good condition, readily visible and easily accessed.
- Onboard equipment must always conform to the governing federal, state and local regulations.
- Never allow any type of spark or open flame on board. It may result in fire or explosion.
- Take the keys/FOBs when leaving the boat to keep untrained and unauthorized persons from operating the boat.
- Know how to react correctly to adverse weather conditions, have good navigation skills and follow navigational rules as defined by USCG, state and local regulations.
- Check local weather reports before casting off. Do not leave the dock area when strong winds and electrical storms are in the area or predicted to be in the area.
- Seek shelter from open water if lightning is an imminent threat.
- Tell someone of the travel plans before departing.
- Know the weight capacity of the boat. Never overload the boat.
- Never operate the boat while under the influence of drugs or alcohol.
- Look before turning the boat. The boater is obligated to maintain a course and speed unless it is safe to alter course and speed. Look before turning.
- Operators must read and understand all operating manuals supplied with the boat before operation.
- Whenever planning an outing, make sure that at least one passenger is familiar with the operation and safety aspects of the boat in case of emergency.
- Passengers should never sit in front of the operator; always avoid obstructing the operator's view.
- Show all passengers the location of emergency equipment and explain how to use it.
- Never allow passengers to drag their feet or hands in the water, or sit on the bow, bow pulpit, deck or gunwale while the engine is running.
- Never use or hold on to the boarding platform while the engine is running.





- Never stand or allow passengers to stand in the boat or sit on the transom, seatbacks, engine cover or sides of the boat while the engine is running. The operator or others may be thrown from the boat.
- Children and nonswimmers must wear a life jacket at all times.
- Never leave children in the boat without adult supervision.
- Improper operation of the boat is extremely dangerous.
- Securely attach the engine emergency stop switch lanyard to a part of your clothing, such as a belt loop, when operating the boat.
- Operate slowly in congested areas such as marinas and mooring areas.
- The bow may be slippery. Do not go forward while the engine is running.
- Slow down when crossing waves or wake in order to minimize the impact on passengers and the boat.
- Never replace the boat's marine parts with automotive parts (if applicable).
- Never remove or modify any components of the fuel system. Always have qualified personnel perform fuel system maintenance. Tampering with fuel components may cause a hazardous condition.
- Avoid contact with engine exhaust gases—engine exhaust contains carbon monoxide.
- Never operate the engine in a confined space.
- Never go under the boat cover with the engine running or shortly after the engine has been running.
- Allow adequate ventilation with fresh air before entering any enclosed areas.
- Watch for other boats, swimmers and obstructions in the water. Stay away from other boats and personal watercraft (PWCs).
- Never swim near a boat when the engine is running. Even if the boat is in the NEUTRAL position, the propeller may still be turning and carbon monoxide may be present.
- Never dive from the boat without being absolutely sure of the depth of the water; severe injury or death may occur from striking the bottom or submerged objects.
- Never wrap ski lines or mooring lines around any body part. You could become entangled in the line if you fall overboard while the boat is moving.
- Keep track of ski lines and dock lines so they do not become entangled in the propeller.
- Have an experienced operator at the helm and always have at least three people present for safe towing—one to drive, one to observe, and one to ski or ride.



## SAFETY DECALS AND STATEMENTS

### SAFETY DECALS

The boat is affixed with various hazard and safety decals at the time of manufacture. These decals appear in specific locations on the boat and on equipment where safety is of particular concern. All operators of the boat must read and understand all hazard and safety decals and advise all passengers on the safety concerns and proper practices. Hazard and safety decals must remain legible. If the operator suspects a decal is missing or damaged they should contact the dealer for immediate replacement.

### SAFETY STATEMENTS

There is no substitute for sound judgment and careful practices. Improper practices or carelessness can cause burns, cuts, mutilation, asphyxiation, other bodily injury or death. This information contains general safety precautions and guidelines that must be followed to reduce risk to personal safety. Special safety precautions are listed in specific procedures. Read and understand all of the safety precautions before operation or performing repairs or maintenance.



**NOTE** — This safety alert symbol appears with most safety statements. It means attention, become alert, your safety is involved! Please read and abide by the message that follows the safety alert symbol.

#### **DANGER**

*Indicates a hazardous situation that, if not avoided, will result in death or serious injury.*

#### **WARNING**

*Indicates a hazardous situation that, if not avoided, could result in death or serious injury.*

#### **CAUTION**

*Indicates a hazardous situation that, if not avoided, could result in minor or moderate injury.*

#### **NOTICE**

*Indicates a situation that can cause damage to the boat and accessories and/or the environment, or cause the equipment to operate improperly.*



## SAFETY PRECAUTIONS



### DANGER

The safety messages that follow have **DANGER** level hazards. These safety messages describe hazardous situations that, if not avoided, will result in death or serious injury.



**Training Hazard:** Do not permit anyone to launch, operate or retrieve the boat without proper training.

- Read and understand this Basic Boating and Safety Manual and all manufacturer-supplied information before operating or servicing the boat to ensure that you follow safe operating practices and maintenance procedures.
- Safety signs and decals are additional reminders for safe operating and maintenance techniques.
- See the boat dealer for additional training.



**Exhaust Hazard:** Carbon monoxide (CO) is a colorless and odorless gas produced by all engines, fuel-burning appliances and any material that contains carbon and is burned. Direct or prolonged exposure to carbon monoxide will cause brain damage or death.



**Electrocution Hazard:** Docks and other boats nearby can carry sources of electricity. Faulty wiring or the use of damaged electrical cords and other devices not approved as “shore or marine rated” can cause the surrounding water source to become energized from electricity leakage. Never enter the water or swim in a marina.



### WARNING

The safety messages that follow have **WARNING** level hazards. These safety messages describe hazardous situations that, if not avoided, could result in death or serious injury.



**Fire/Explosion Hazard:** Gasoline is extremely flammable and highly explosive under certain conditions.

- Compartments for fuel, flammable liquids or gases must be properly ventilated to prevent explosive vapors from accumulating. Most vapors are heavier than air. If not in a vapor-tight locker vented overboard, vapors will accumulate in the bilge, posing a fire and explosion hazard.
- Inspect fuel system for leaks at least once a year.



**Fire/Explosion Hazard:** Hydrogen gases produced by a lead-acid battery while it is charging, or the engine is running, can cause an explosion and/or a fire.

- **Always wear personal protective equipment when working on or around batteries.**
- **Keep the area around the battery well-ventilated.**
- **Do not smoke or bring an open flame or any other form of ignition near a battery.**
- **Do not check for a dead battery by placing a metal object between the battery posts. Sparks could cause an explosion.**
- **Do not place your head directly above a battery when making or breaking electrical connections.**
- **Always charge the battery outside of the boat.**
- **Do not use a battery booster to start the engine.**



**Sever Hazard:** Make sure nobody is near the propeller before starting the engine(s).

- **Do not allow swimmers to approach or use the ladder when the engine is running.**
- **The operator should walk to the stern and check the water for people near the propeller, as people in the water may not always be noticeable from the helm.**
- **Turn off the engine(s) before allowing people to board or exit the boat. The propeller may continue rotating even when the engine is idling or in NEUTRAL.**
- **Show passengers the location of the propeller and teach them to keep their distance from it at all times, even when the propeller is not in motion.**
- **Show passengers the propeller warning labels around the boat and discuss propeller dangers.**
- **Be particularly alert when boating in high-traffic areas and never operate in swimming zones.**
- **Exercise caution when operating near boats that are towing skiers and tubers.**
- **Never allow passengers to sit in areas where they could fall overboard, including the bow, gunwale, transom, seat backs, or other locations.**



- **Carefully watch children aboard the boat at all times.**
- **Instruct passengers on the rules for using the swim platform, boarding ladders and seats. If possible, instruct them to stay seated at all times while the boat is underway.**



**Man Overboard Hazard: Always remain seated in the boat manufacturer's designated seating arrangement, use handholds and never block the view of the boat operator while underway. The boat's bow, gunwale, transom platform and seat backs are not intended for use while underway.**

- **If someone falls overboard, slowly turn the boat around while keeping an eye on the victim. Ask a passenger to help monitor the victim. Always STOP THE ENGINE before rescuing a victim from the water.**
- **Never put the engine in REVERSE to retrieve a person from the water. Slowly circle back to the person again if necessary.**



**Entanglement Hazard: Rotating or moving parts can entangle or sever body parts.**

- **Do not wear jewelry, unbuttoned cuffs, ties or loose-fitting clothing.**
- **Tie long hair back when working near moving or rotating parts such as the flywheel or propeller shaft.**
- **Keep hands, feet and tools away from all moving parts.**
- **Keep all guards in place when the engine is operating.**
- **Use caution when working with ski or mooring lines so they do not become entangled with the propeller.**



**Exposure Hazard: Wear personal protective equipment, including appropriate clothing, gloves, work shoes, eye and hearing protection, as required by the current task.**



**Control Hazard: Do not operate the boat while you are under the influence of alcohol or drugs or if feeling ill. Federal laws prohibit operating a boat under the influence of alcohol or drugs. These laws are vigorously enforced.**

**CAUTION**

The safety messages that follow have **CAUTION** level hazards. These safety messages describe hazardous situations that, if not avoided, could result in minor or moderate injury.



**Slip/Trip Hazard: Keep the boat free of water, oil, mud and other foreign matter. Do not wax deck and swim platform surfaces. Remove anything that creates slippery areas around the boat.**

**NOTICE**

The safety messages that follow have **NOTICE** level hazards. These messages are used to indicate a situation that can cause damage to the boat and accessories and/or the environment, or cause the equipment to operate improperly.

- *Unapproved modifications to the boat or systems may impair the boat's safety and performance characteristics and shorten the boat's life. Any alterations to the boat may void its warranty. Always consult the boat manufacturer before making modifications or adding equipment.*
- *ALWAYS be environmentally responsible. Follow the guidelines of the EPA or other governmental agencies for the proper disposal of hazardous materials such as engine oil and fuel. Consult the local authorities or reclamation facility.*



## CARBON MONOXIDE (CO)



**DANGER**

*Exhaust Hazard:*

**CO gas is colorless, odorless and extremely dangerous. All engines and fuel-burning appliances produce CO as exhaust. Direct and prolonged exposure to CO will cause brain damage or death. Always avoid exposing your passengers or yourself to CO.**

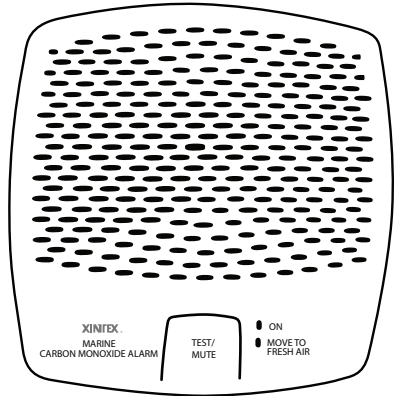

KC-0387-A

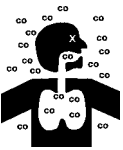

Even with the best boat design and construction, plus the utmost care in inspection, operation and maintenance, hazardous levels of CO may still be present in accommodation areas under certain conditions. To reduce CO accumulation, always provide adequate ventilation in the boat interior by opening the deck hatches, windows or canvas.

Do not confuse carbon monoxide poisoning with seasickness, intoxication or heat stress. If someone complains of irritated eyes, headache, nausea, weakness, dizziness or drowsiness, or you suspect carbon monoxide poisoning, immediately move the person to fresh air, investigate the cause and take corrective action. Seek medical attention if necessary.

Always use a CO detector in confined areas where there is a possibility of CO buildup, such as enclosed canvas, sleeping quarters, galleys and head compartments. Regularly check the condition of the CO detector for proper operation.

Test the carbon monoxide detector operation before each trip, at least once a week and after the boat has been in storage. Also have the CO detectors professionally tested at regular intervals. Most CO detectors are required to be replaced every 5 years – see the OEM manual.



## Potential Causes of CO Poisoning While Under Way

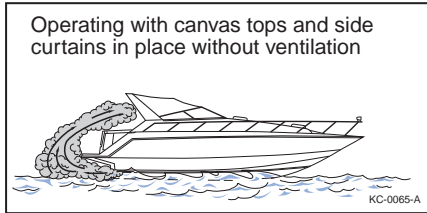
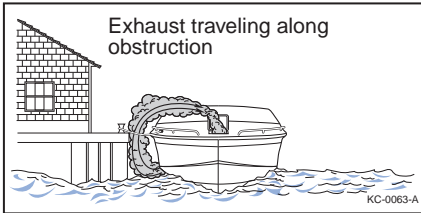
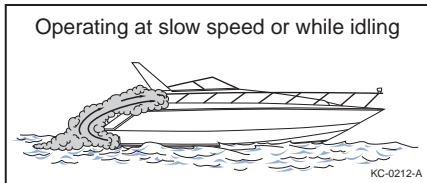
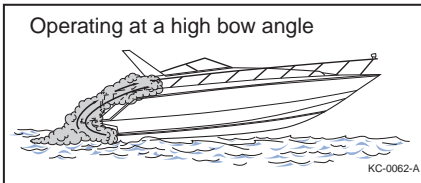
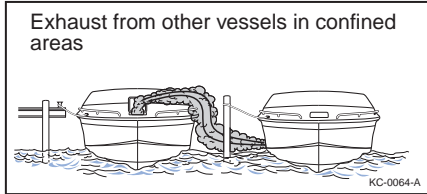
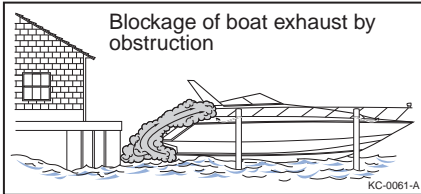

**Always ensure adequate fresh air ventilation through the boat when under way.**



KCB-0049





## REQUIRED BOATING SAFETY EQUIPMENT AND REGULATIONS

**U.S. Coast Guard Minimum Onboard Personal Safety Equipment Required  
(Your boat may be equipped with one or more requirements by the manufacturer.)**

	LESS THAN 16 FT (4.9 M)	CLASS 1: 16 TO LESS THAN 26 FT (4.9 TO LESS THAN 7.9 M)	CLASS 2: 26 TO LESS THAN 40 FT (7.9 TO LESS THAN 12.2 M)	CLASS 3: 40 TO 65 FT (12.2 TO 19.8 M)
<b>LIFE JACKETS AND PERSONAL FLOTATION DEVICES (PFDs)</b>	One U.S. Coast Guard-approved Type I, II, III or V wearable life jacket for each person on board	One U.S. Coast Guard-approved Type I, II, III or V wearable life jacket for each person on board and one throwable Type IV PFD device		
<b>VISUAL DISTRESS SIGNALING DEVICES</b>	One (1) electric distress light OR three (3) day and night combination red flares	One orange distress flag or one electric distress light OR three floating or handheld orange smoke signals and one electric distress light OR three day and night combination red flares, handheld, parachute or meteor type		
<b>AUDIBLE SIGNALING DEVICES</b>	A boat less than 39.4 ft (12 m) must have on board an efficient sound-producing device. (Example: hand or mouth whistle OR a compressed or powered air horn)	A boat less than 39.4 ft (12 m) must have on board an efficient sound-producing device. (Example: hand or mouth whistle OR a compressed or powered air horn) A boat 39.4 ft (12 m) but less than 65.6 ft (20 m) in length operating in inland waterways must carry a power whistle OR powered air horn AND a bell		
<b>NAVIGATION LIGHTS</b>	Regulations require that navigational lights be clearly lit and properly displayed at all times between sunset and sunrise and always when operating in reduced visibility while boating			



	LESS THAN 16 FT (4.9 M)	CLASS 1: 16 TO LESS THAN 26 FT (4.9 TO LESS THAN 7.9 M)	CLASS 2: 26 TO LESS THAN 40 FT (7.9 TO LESS THAN 12.2 M)	CLASS 3: 40 TO 65 FT (12.2 TO 19.8 M)
<b>FIRE EXTINGUISHERS</b>	<p>One B-I type (U.S. Coast Guard-approved)</p> <p>If the boat meets any one or more of the following conditions, the boat must carry one B-I type USCG-approved extinguisher on board:</p> <ul style="list-style-type: none"><li>• Inboard/sterndrive engine powered</li><li>• Has closed compartments where portable fuel tanks can be stored</li><li>• Has double bottom construction that has areas where air or gases can be open or trapped</li><li>• Has an enclosed living space</li><li>• Has compartments where flammable, combustible or explosive materials are stored</li><li>• Has permanent fuel tanks installed</li><li>• Boat is 26 ft (7.9 m) or more in length</li></ul>		<p>One B-II OR two B-I type (USCG-approved) (A fixed extinguishing system is equal to one B-I.)</p>	<p>One B-II AND one B-I OR three B-I type (USCG-approved) (A fixed extinguishing system is equal to one B-I OR two B-II.)</p>



## FIRE EXTINGUISHER

USCG-approved fire extinguishers are required on all Class I, II and III boats. Mount all handheld fire extinguishers in readily accessible areas away from the engine compartment and other combustible devices. All passengers must know the location and operating procedure of each extinguisher. Follow the manufacturer's instructions for proper use and operation of the fire extinguisher.

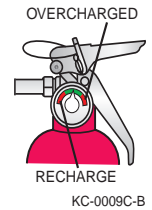

All fire extinguishers used on marine boats must be classified to extinguish type B fires (gasoline, oil or grease). The size and number of required fire extinguishers depend on the size of the boat. The two type B fire extinguishers commonly used are B-I and B-II. Type B fire extinguishers are classified by the different extinguishing compound amounts used in each.

Check the fire extinguisher condition and pressure gauge regularly, if not before every trip, to ensure that the fire extinguisher is in good operating condition and is fully charged. If the fire extinguisher is damaged or not properly pressurized, replace it.

See the U.S. Coast Guard Minimum Onboard Personal Safety Equipment Required section of this manual for specific onboard requirements.

## ENGINE EMERGENCY STOP SWITCH AND LANYARD

The engine emergency stop switch is an extremely important safety precaution. Use the engine emergency stop switch when operating the boat's engine. This safety device prevents the boat from becoming a runaway if the operator is accidentally thrown from the seat or away from the helm.

Before turning on the boat's engine, secure the engine emergency stop switch lanyard to the operator. If the operator is thrown from the seat or moves too far from the helm, the lanyard will disconnect from the switch, activating the switch to turn off the engine.

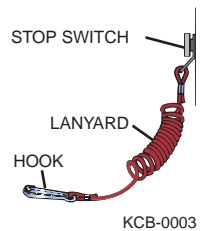

**WARNING**

**Control Hazard: Never remove or modify the engine emergency stop switch and/or lanyard.**

- ***Always check the switch for proper operation. With the engine running, pull the lanyard. If the engine does not stop, have the switch repaired before continuing to operate the boat. Never operate the boat if the engine emergency stop switch does not work.***
- ***Attach the engine stop switch cord lanyard to a secure place on your clothing, your arm or leg while operating.***
- ***Avoid accidentally pulling the cord lanyard during normal operation. Loss of engine power means loss of most steering control. Also, without engine power, the boat could slow rapidly. This could cause people and objects in the boat to be thrown forward.***
- ***DO NOT attach the cord lanyard to clothing that could tear loose. DO NOT route the cord lanyard where it could become entangled, preventing it from functioning.***

## LIFE JACKETS

Boaters enjoy the feel of sun and spray, so it's tempting to boat without wearing a life jacket, especially on nice days. However, the failure to wear life jackets is by far the number one cause of boating fatalities.

Modern life jackets are available in a wide variety of shapes, colors, sizes and technologies. Many are thin and flexible. Some are built right into fishing vests or hunter coats. Others are inflatable and as compact as a scarf or fanny pack until they hit water and automatically fill with air.

There's no excuse for not wearing a life jacket on the water. Boat dealers or marine stores are the best sources for guidance when selecting this most important piece of safety equipment.

### ***Things to Know about Life Jackets:***

- Certain life jackets are designed to keep the head above water and help you remain in a position that permits proper breathing.
- To meet USCG requirements, a boat must have a USCG-approved life jacket for each person aboard. Boats 16 feet and over must have at least one Type IV throwable device as well.



- All states have regulations regarding children wearing life jackets.
- Adult-sized life jackets will not work for children. Special life jackets for children are available. To work correctly, a life jacket must be worn, fit snugly and not allow the child's chin or ears to slip through.
- Life jackets can be equipped with whistles, strobe lights, handheld VHF radios and personal locator beacons.
- Life jackets are recommended for open water.
- Test life jackets for wear and buoyancy at least once each year. Discard waterlogged, faded or leaky jackets.
- Properly stow life jackets but make them easily accessible.
- A life jacket, especially a snug-fitting flotation coat or deck-suit style jacket, can help people survive in cold water.

### ***Life Jackets Must Be:***

- USCG-approved
- In good and serviceable condition
- Appropriately sized for the intended user
- The best life jacket is the one you will wear

### ***Accessibility***

- Wearable life jackets must be readily accessible.
- Boaters must be able to locate and put them on in a reasonable amount of time in an emergency.
- They should not be stowed in plastic bags, in locked or closed compartments or have other gear stowed on top of them.
- Throwable devices must be immediately available for use in emergency situations.
- Though not required, a life jacket should be worn at all times when the boat is underway. A life jacket can save a boater's life, but only if the boater wears it. Set the example and wear it whenever near the water.

### ***Child Life Jacket Requirements***

Some states require that children wear life jackets at all times; check with the state boating safety authorities.

- Applies to children of specific ages
- Applies to certain sizes of boats
- Applies to specific boating operations



Child life jacket approvals are based on the child's weight. Check the "user weight" on the label, or the approval statement that will read something like "Approved for use on recreational boats and uninspected commercial boats not carrying passengers for hire, by persons weighing XX lbs." They can be marked "less than 30," "30 to 50," "less than 50," or "50 to 90."

Since children grow quickly, many boat launches now feature free use of children's life jackets in several different weight categories.

## Life Jacket Requirements for Certain Boating Activities Under State Laws

The USCG recommends, and many states require, wearing USCG-approved life jackets:

- For waterskiing and other towed/surf activities, use a life jacket designed for waterskiing. **It is illegal in many states to participate in towed water sports without a USCG-approved life jacket. Be aware that some specialized water sports vests are NOT USCG-approved and should be worn in addition to a USCG-approved life jacket.**
- While operating personal watercraft (PWC) use a life jacket marked for PWC or waterskiing use.

Check with the state boating safety authorities. Other rules may apply if boating in an area under the jurisdiction of the Army Corps of Engineers or a federal, state or local park authority. Special local rules are usually posted at the boat launch.

### Type I Life Jacket

This life jacket is designed so that the person wearing it turns to a face-up position when conscious or unconscious. Type I life jackets are the most buoyant and are effective on all waters, especially when rescue is delayed or flotation time is extended.



TYPE I

KC-0003C-A

### Type II Life Jacket

This life jacket is recommended for use in calm water near shore on most inland waters where quick rescue is likely. A Type II life jacket is similar to a Type I life jacket, but it is not as buoyant or effective in turning the wearer to a face-up position.



TYPE II

KC-0006C-A



### Type III Life Jacket

This life jacket is designed for personal buoyancy when the wearer is alert and conscious. Type III life jackets require users to turn themselves to a face-up position. Type III life jackets are recommended in most inland water applications where quick rescue is likely or when used in the presence of other people.



TYPE III

KC-0004C-A

### Type IV Personal Flotation Device

These PFDs are designed to be thrown to a person in the water who can grab and hold it while being rescued. Never wear a Type IV PFD.



TYPE IV

KC-0007C-A

### Type V Life Jacket

This life jacket is designed for special activities and may be worn instead of a Type I, II or III life jacket if used in accordance with the approval conditions on the label. If a Type V life jacket is part of the minimum onboard life jacket requirements and if it has a label that indicates “required to be worn,” it must be worn at all times. Otherwise one additional Type I, II or III life jacket must be on board to satisfy the minimum life jacket requirements. Some Type V life jackets provide increased protection against hypothermia.



TYPE V

KC-0005C-A



## VISUAL DISTRESS SIGNALING DEVICES

Boats less than 16 feet (4.9 meters) must have USCG-approved visual distress signals (VDS) on board when operating between sunrise and sunset in coastal waters, including ocean bays, gulfs and sounds, as well as the Great Lakes, seas, bays and river mouths that are 2 or more miles wide and only to the point proceeding inland where the water narrows to less than 2 miles. Visit the U.S. Coast Guard website for additional information on specific VDS requirements for the boat.

Ensure all passengers on board understand how to operate all VDS. Keep VDS in a readily accessible area and within immediate reach at all times when boating.

### VISUAL DISTRESS SIGNALS

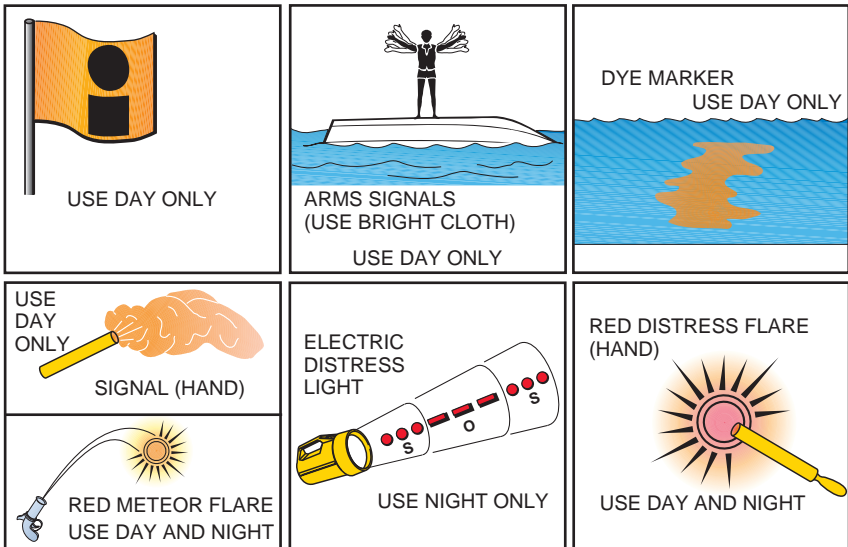

KC-0008C-B

Regulations prohibit using pyrotechnic VDS or any VDS in non-emergency situations.

VDS must be:

- USCG-approved
- In proper operating condition
- Safely stowed and readily available
- Within the clearly marked expiration date stamp on the device (where applicable)





Types of VDS vary by emergency situation. VDS are classified as either pyrotechnic or non-pyrotechnic.

**NOTE** — Some pyrotechnics may be restricted on certain bodies of water. Check with local authorities, or visit the National Association of State Boating Law Administrators (NASBLA) website: <http://www.nasbla.org> or the U.S. Coast Guard website: <http://www.uscg.mil> for additional information.

See the U.S. Coast Guard Minimum Onboard Personal Safety Equipment Required section of this manual for specific onboard requirements.

## AUDIBLE SIGNALING DEVICES

Audible (sound) signals are required to be on board all boats to alert other boats of your presence. A boat less than 39.4 feet (12 meters) must always have an efficient sound-producing device on board (Example: hand or mouth whistle, or a compressed or powered air horn).

A boat at least 39.4 feet (12 meters) but less than 65.6 feet (20 meters) operating in inland waterways must always have a power whistle or powered air horn and a bell on board.

All devices must be acceptable for use in marine environments, audible for 1/2 nautical mile and maintain a continuous four- to six-second sound duration. The diameter of the bell's mouth must be a minimum of 7.9 inches (20.0 centimeters).

Ensure all passengers understand how to operate all audible distress signaling devices on board. Keep these devices in a readily accessible area and within immediate reach at all times when boating.

See the U.S. Coast Guard Minimum Onboard Personal Safety Equipment Required section of this manual for specific onboard requirements and see the Navigational Lights and Night Operation section of this manual for usage information.

## NAVIGATIONAL LIGHTS

Navigational lights are intended to alert other boats to your presence and course.

Regulations require that navigational lights be clearly lit and properly displayed at all times between sunset and sunrise, and always when operating in reduced visibility. The placement, shape and visibility requirements of navigational lights may vary depending on usage. Check with local authorities, or visit the NASBLA or U.S. Coast Guard website for additional information.

For additional information, see the Navigational Lights and Night Operation section of this manual.



## UNAPPROVED LIGHTING

The navigational lighting required by the USCG from sunset to sunrise and in inclement weather is extremely important to boat navigation. The lighting rules are not only designed to indicate direction and right-of-way, but are also designed to prevent night blindness and confusion with navigational aid, emergency and shore-based lights.

### NOTICE

*Onboard accessory equipment equipped with red/green/blue LED lighting should never be used when underway. The blue LED should never be used and is banned in several states. Blue lights are for law enforcement only.*

Installing supplemental lighting for “show” can be very dangerous, confusing, distracting and may be illegal. Some light colors may not be compliant with certain local ordinances. Blue lighting is reserved for marine authorities and is illegal to use on boats. The operator is responsible for knowing and complying with local laws and must be familiar with local marine lighting regulations before use, even with certain factory-installed lighting.

Never add lighting above the waterline. Avoid lighted accessories such as speakers or light rope. Switch off underwater lights when underway. Use only factory-installed, low-intensity courtesy lighting on the water.



## RECOMMENDED SAFETY EQUIPMENT

Carry and know how to use the following equipment in addition to the required equipment on board at all times as an extra safety precaution:

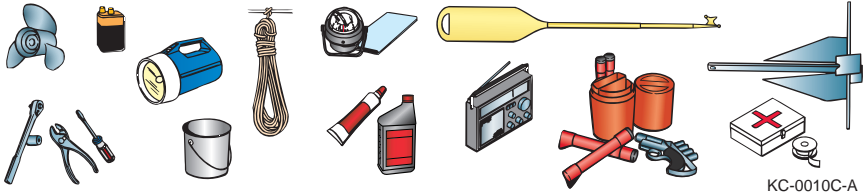

KC-0010C-A

	INLAND LAKES & RIVERS	COASTAL & INTRACOASTAL WATERS	GREAT LAKES & OCEAN WATERS
Spare keys/FOBs/stop-switch lanyards	•	•	•
Cell phone with waterproof case and lanyard	•	•	•
Mobile device power pack (battery)		•	•
Solar USB charger and cables	•	•	•
Night vision thermal imaging device such as FLIR		•	•
Emergency position indicating radio beacon (EPIRB)		•	•
Personal locator beacon (PLB)			•
Handheld waterproof GPS			•
Handheld waterproof VHF radio			•
Handheld waterproof compass			•
Handheld waterproof two-way radios			•
Satellite communications (SATCOM) device for automatic GPS coordinate updates		•	•
Ditch kit		•	•
Dry bag	•	•	•
Survival (immersion) suit			•
Mirror, whistle and strobe light	•	•	•
Life ring/throwable personal flotation device (PFD)	•	•	•
Foul weather gear and thermal clothing		•	•
Throw raft with oars		•	•



	INLAND LAKES & RIVERS	COASTAL & INTRACOASTAL WATERS	GREAT LAKES & OCEAN WATERS
First aid kit and manual/app	•	•	•
Emergency food and water for 3 days minimum in open water			•
Ring buoy			•
Spare anchor and at least 150 feet (46 meters) of 5/8-inch or heavier anchor line		•	•
Sea anchor		•	•
Heaving, mooring and towing lines	•	•	•
Fenders and boat hook	•	•	•
Waterproof flashlight, radio and spare batteries		•	•
Radar reflector(s)			•
Sunscreen, insect repellent and sunglasses	•	•	•
Navigational charts		•	•
Binoculars	•	•	•
Tool kit including propeller replacement tools	•	•	•
Sharp folding pocket knife	•	•	•
Spare propellers and hardware, one each right-hand and left-hand rotation		•	•
Spare parts: pumps, belts, filters		•	•
Bung plugs for each thru-hull port size		•	•
Crash pump (bilge suction line with valve connected to engine raw water pump intake)			•
Duct and electrical tape	•	•	•
Engine oil (one gallon per engine)	•	•	•
Extra transom plugs	•	•	•
Selection of in-line fuses as required	•	•	•



## VERY HIGH FREQUENCY (VHF) RADIO

The VHF radio is used to communicate with others on and off the water. VHF channel 16 (156.8 MHz) is designated as the international distress, safety and calling channel and is used to summon rescue services such as the USCG and to make initial contact with ports, marinas, bridges, locks and other boaters in the area. Use a VHF radio. The best way to clearly understand and deal with crossing, overtaking and meeting situations in open water is to communicate with the other boat on the radio.

The responder may then ask the caller for other information to help the caller. It is important to remain calm, speak slowly and be succinct. Short and concise communications are best no matter what the situation is.

Since VHF radios have limited distance line-of-sight (to the horizon) capabilities, it is important for all boaters receiving the distress call to attempt to render assistance until the rescue authorities arrive. The very nature of open water escalates the importance of any distress call. Boaters should always monitor (listening watch) channel 16 but never use it for casual communications. Assist others in distress if possible or monitor the situation until help has arrived.

In other communications, call the other party on channel 16 using your call sign. Bridges and locks will instruct boaters on what to do. Harbors, marinas and other boaters in the area will inform boaters to switch to a particular channel. Most VHF radios transmit in “simplex,” where communication can only take place in one direction at a time. For this reason, standard etiquette is to never interrupt a transmission and to wait 15-30 seconds before making a transmission. There are many channel options available for both commercial and non-commercial use.

### NOTICE

*The USCG is the lead agency for maritime search and rescue (SAR) in U.S. waters, but that mission is compromised every time the service receives a hoax distress call. Making a false distress call is a violation of federal law (14 U.S. Code § 88) and may result in up to six years in prison, a \$250,000 criminal fine, a \$5,000 civil fine, and reimbursing the U.S. Coast Guard for the cost of performing the search.*

Using a VHF radio in foreign waters with a U.S.-registered boat may require a federal Ship Station License by law or treaty. Traveling to a foreign port (for example, Canada, Bahamas, British Virgin Islands and Mexico) requires a Ship Station License as well as a restricted radiotelephone operator permit (RR). Go to [www.fcc.gov/wireless/bureau-divisions/mobility-division/ship-radio-stations](http://www.fcc.gov/wireless/bureau-divisions/mobility-division/ship-radio-stations) for more information.

Read the VHF manufacturer’s information on the special features and use of the radio.



## RADAR

If the boat is equipped with radar, study the manual to know how to tune, make clutter adjustments, switch ranges, set alerts, etc. Radar is an excellent safety tool for cruising in shipping channels but should never be used in place of situational awareness or a proper lookout.

## RADAR REFLECTORS

Before cruising in open water at night, in inclement weather or in shipping lanes, install radar reflectors. Radar reflectors increase the signature of the boat on radar. Use at least two reflectors measuring 18 inches (46 centimeters) or more diagonally. Contact a dealer for help in choosing from several types of reflectors. Mount the reflectors as high as possible above the waterline—one forward, one aft for 360-degree coverage. Mounts are available for both surface and rail mounting. Having radar reflectors increases visibility but is not a substitute for an active watch.

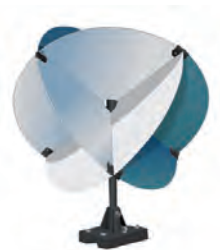

KCB-0051

## GLOBAL MARITIME DISTRESS AND SAFETY SYSTEM (GMDSS)

GMDSS, originally developed for international commercial ships, increases safety and reduces search and rescue (SAR) efforts by standardizing procedures and integrating several new and old technologies. Although recreational boats do not need to comply with GMDSS, some GMDSS technologies are available to recreational boaters to increase safety, particularly in shipping lanes and offshore in open waters. Components of interest to recreational boaters are as follows:

- Digital selective calling (DSC) on select VHF marine radios (VHF-DSC)
- Emergency position indicating radio beacon (EPIRB) stand-alone units
- Automatic identification system (AIS) integrated into various electronics
- Global positioning system (GPS) stand-alone or integrated into various electronics such as a chartplotter utilizing electronic nautical charts (ENCs)



For more information on GMDSS, go to: [www.navcen.uscg.gov](http://www.navcen.uscg.gov). Boat dealers are the best sources to use for making an informed decision on adding or integrating safety systems in the boat.

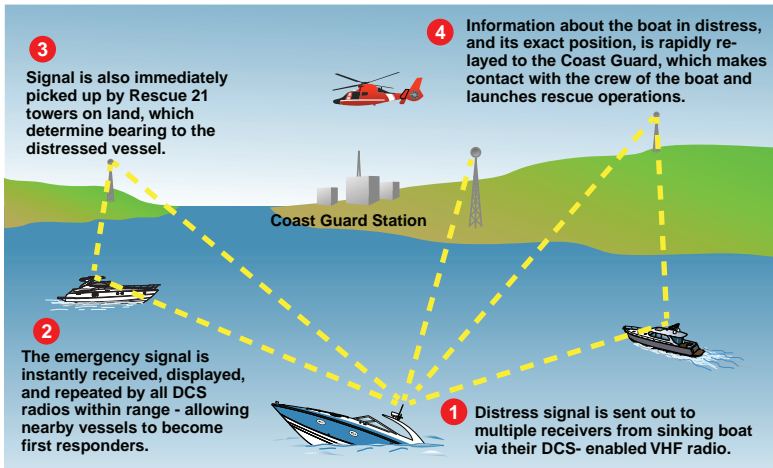

KC-6013

## VHF-DSC RADIO

The VHF-DSC is a newer type of radio that does everything a standard VHF radio does but includes enhanced distress alerting capabilities as part of the global maritime distress and safety system (GMDSS). DSC transfers distress alerts digitally on channel 70 with location and specific boat identity with just a push of a button. VHF-DSC radios can contain other built-in GMDSS functions such as a global positioning system (GPS) and an automatic identification system (AIS). In order for the VHF-DSC to function properly:

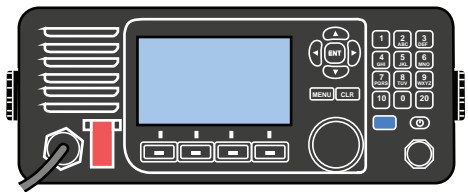

KC-6003

1. The boat must be registered with the USCG database for boat identity purposes (see *Obtaining a Marine Mobile Service Identity [MMSI]* in this section).
2. The VHF-DSC must be interconnected with a GPS for location information.



## Obtaining a Marine Mobile Service Identity (MMSI)

An MMSI is a nine-digit number, somewhat like a phone number, that identifies a specific boat. An MMSI number is programmed into all of the boat electronics that are capable of transmitting and receiving digital signals. Recreational boaters must register to receive an MMSI number assignment if they meet certain criteria.

MMSIs are also linked to the boat owner and can be transferred from an old boat to a new boat. However, if a boater also has a hand-held VHF-DSC radio with the same MMSI number and sells the boat, it is best to include the handheld radio as part of the boat sale. Changing the owner information in the MMSI record is easier than resetting the MMSI number in the radio(s).

Boat owners can also have multiple MMSIs linked to an account for multiple boats. Registering for an MMSI requires several pieces of information including:

- Radio call sign
- Ship classification (several in recreational category)
- EPIRB identification code (if used)
- Boat registration number
- Primary and alternate emergency contacts
- Boat capacity

There are several websites for applying for MMSI registration. Some are free and some have a fee or require membership to important marine organizations and services. For more information, go to: [www.navcen.uscg.gov/?pageName=mtMmsi](http://www.navcen.uscg.gov/?pageName=mtMmsi).

## Connecting VHS-DSC with GPS

All DSC-equipped radios and most GPS receivers have a National Marine Electronics Association (NMEA) 0183 two-wire data protocol. That NMEA protocol connects any model of GPS to any model of radio, regardless of manufacturer. Consult the VHF and GPS manufacturer's information on connecting and programming the radio.





## A Word on AIS

AIS is a shipboard broadcast system that acts like a transponder and operates in the VHF maritime band. AIS enables direct hailing of other AIS-equipped boats via properly configured VHF-DSC. AIS is automatic and enhances the signature of the boat, which may not otherwise be seen on radar. Class B AIS equipment for non-commercial use must be USCG-approved and the boat must have an MMSI number programmed. Transmit and receive AIS signatures whenever possible.

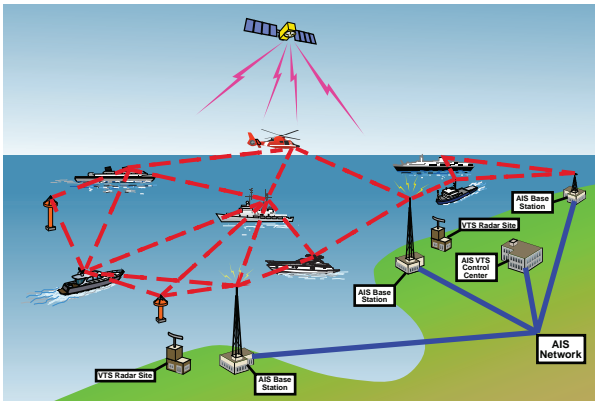

KC-6012

Most VHF-DSC radios are equipped with these important features:

- A “distress” button for instant broadcast of an emergency situation with GPS coordinates and MMSI information. Automatically broadcasts to all DSC units in the vicinity with a single push of the button.
- A “test call” feature that provides an automatic response if the radio’s DSC functions are operational
- The ability to build a directory for “speed dialing” other frequently used MMSI numbers
- Automatic (and silent) “listening watch” of channel 70 used for digital distress calls

Enabling and utilizing all the available features of VHF-DSC is one of the most important safety features for recreational boating in the Great Lakes, coastal and ocean waters to ensure the fastest response in an emergency. Thoroughly read the VHF-DSC, GPS, EPIRB and other electronics user manuals for specific connection, feature and operation information.



## EMERGENCY POSITION INDICATING RADIO BEACONS (EPIRBs)

If cruising in the Great Lakes, coastal and ocean waters, consider purchasing an EPIRB. In the U.S., boaters must use a U.S.-coded 406 MHz unit and must register the unit with the National Oceanic and Atmospheric Administration (NOAA) by law: [www.sarsat.noaa.gov/beacon.html](http://www.sarsat.noaa.gov/beacon.html). EPIRBs use GPS technology to identify a boat's exact location along with its unique identification number, which is sent directly to the NOAA Search and Rescue Satellite (SARSAT). SAR authorities then have all the information on the boat and its location in minutes and can initiate search and rescue operations far more quickly and efficiently. EPIRBs have long-lasting batteries, but replace them every few years as stamped on the unit.

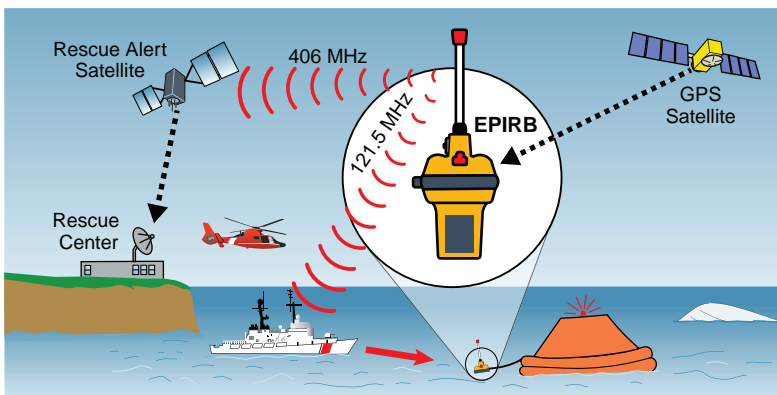

KC-6011

## SAFETY AND TRAINING

There is a vast amount of recreational boating regulatory, safety and training information online, and much of it is free. This information covers laws, aids to navigation, rules of the road, hands-on boating safety courses, boat safety checks and much more for both novices and experienced boaters. Go to the following sites for more information:

- United States Coast Guard  
[www.uscgboating.org](http://www.uscgboating.org)
- United States Power Squadron  
[www.usps.org](http://www.usps.org)
- BoatU.S. Foundation  
[www.boatus.org](http://www.boatus.org)



## SITUATIONAL AWARENESS

A good captain knows that it is important to continuously observe the surroundings and traffic when operating. Good captains also use their eyes to track things around the boat and their ears to hear engine and mechanical issues. Technology should only be used to supplement the conditions and events happening around you and is not meant to replace situational awareness. While available technology and automation help captains see the big picture, the captain is responsible for knowing what is going on around the boat. If possible, post a lookout or lookouts when underway.

Do not get immersed in the boat's technology or blindly follow GPS routes without keeping watch or consulting depth charts. Study the manuals for each piece of equipment and monitor the information for the task at hand, be it depth, traffic, infrared camera, engine data, course or weather.

## DRIVING DEFENSIVELY

Sharing boats is becoming more popular in the boating culture. Boating has seen an influx of new, inexperienced and untrained boaters due to peer-to-peer boat-sharing apps. It is increasingly probable that someone on the water "tried" boating because it looked fun. Many of the boat owners sharing their boats do little more than cover safety equipment, starting, stopping and docking instructions. With shares lasting half a day or less, there is little time for much training, let alone covering the rules of the road and navigation.

Boat-sharing is in a legal gray area and is not clearly defined in maritime law. Enforcement of existing rules is nearly impossible and almost always after-the-fact. Operators should assume that the other boat operator is untrained and should drive defensively. Boaters choosing to share their boat should discuss the issue with their insurance agent first and consider a mandatory captain requirement. Use only reputable sharing services and frequently check for new or updated USCG and state requirements.

## SMALL BOATS AND SWIMMERS

Canoes, kayaks, paddleboards and swimming inflatables have become impulse purchases for many, as they appear fun to use and prices have fallen. Most of these operators are new to the sport and have no training on rules of the road or navigation. This is further complicated by the low, thin profile that makes these small boats difficult to see, especially in the sun, glare and rough water. Operators should keep a close lookout for these boats, swimmers and other boats. Assume that the person is untrained and give them plenty of space.



## KNOWING THE BOAT

Be thoroughly familiar with onboard systems and other equipment, especially the critical equipment such as throttle and shift controls, steering, backup steering, running lights, fuel filters, sea strainers, etc. Should an emergency arise, the captain will need to act safely and efficiently.

## SPECIAL NEEDS PASSENGERS

Keep these special precautions in mind when enjoying a day on the water with passengers who have special needs.

### Toddlers

- Never leave children in the boat without adult supervision.
- Must weigh at least 18 pounds (8.2 kilograms), since that is the smallest children's life jacket approved by the USCG. Life jacket must be worn whenever near the water.
- Any device the child is placed in must have flotation.
- Child-proof the boat just like a home. Be sure all gates and compartments are closed and latched.
- Keep a close watch on the child's reaction to speed and conditions and react accordingly.
- Use a higher than normal SPF waterproof sunscreen and re-apply more often than usual.
- Find a safe area to put the child down without risk of going overboard. Allow the child to get accustomed to the surroundings before launching/leaving.
- Keep trips short, but let them have some fun if possible.

### Pregnant Women

- Go boating during the day and in calm seas.
- Avoid sharp turns and slow down for large wakes.
- Drink more water than usual to stay hydrated.
- It is a good idea to stay seated in the accommodation deck area while underway.
- Stay close to the home port in the third trimester.



## People with Handicaps and Elderly People

Depending on the disability, there are many marine-specialized options available to make boats safer and friendlier. Researching on the internet for your specific needs is the best way to start.

### Pets

- Not all pets can swim; consider a life jacket.
- If playing fetch in the water, get a pet-friendly boarding ramp to make reboarding easier.
- Provide a shaded area and plenty of fresh drinking water.
- Consider foot protection for hot sand and boat surfaces.
- Allow the pet to get accustomed to the surroundings before launching/leaving. Keep the first outing short to allow the pet to get used to the boating environment.

## CRUISING LIMITATIONS

- Scan constantly for people, objects and other watercraft. Be alert for conditions that limit your visibility or block your vision of others.
- Operate defensively at safe speeds and keep a safe distance from people, objects and other watercraft.
- Do not follow directly behind other watercraft.
- Do not go near others to spray or splash them with water.
- Avoid sharp turns or other maneuvers that make it hard for others to avoid you or understand where you are going.
- Avoid areas with submerged objects or shallow water.
- Operate within your limits and avoid aggressive maneuvers to reduce the risk of loss of control, ejection and collision.
- This is a sophisticated boat—not a toy. Sharp turns or jumping waves or wakes can increase the risk of back/spinal injury (paralysis), facial injuries, broken legs, ankles and other bones. Do not jump waves or wakes.
- Do not operate the boat in rough water, bad weather or when visibility is poor; this may lead to an accident causing injury or death. Be alert to the possibility of bad weather. Take note of weather forecasts and the prevailing weather conditions before setting out in the boat.
- Leave a “float plan” with a responsible person on shore. Tell where you plan to go and when you plan to arrive, and provide a description of your boat. Advise this person if your plans change and also when you arrive to prevent false alarms. Refer to *Float Plan* in this manual for additional information.



## HAZARD INFORMATION

- Never start the engine or let it run for any length of time in an enclosed area. Exhaust fumes contain carbon monoxide, a colorless, odorless gas that may cause death within a short time. Always operate the boat in an open area.
- Do not use the reverse function to slow down or stop the boat, as it could cause you to lose control, be ejected or impact the steering wheel or other parts of the boat. This could increase the risk of serious injury. It could also damage the shift mechanism.
- Reverse can be used to slow down or stop during slow speed maneuvering, such as when docking. Once the engine is idling, shift to REVERSE and gradually increase engine speed. Make sure that there are no obstacles or people behind you before shifting into REVERSE.
- Stop the engine and remove the clip from the engine stop switch before removing any debris or weeds that may have collected around the propeller.

## TOWING A TENDER

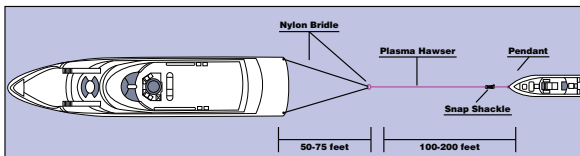

KCB-0056

Towing in open waters can be the most convenient way to keep the boat's tender handy. Most tenders can be equipped with tow points for towing behind the boat. Towing can produce tremendous strain on both the tender and the boat, so have a professional install dedicated tow eyes/bitts. Equally important in towing is the type of bridle, so consult with the boat dealer and consider a custom bridle from a marine rope specialist.

- When towing outboard-powered models, secure the outboard in the full tilt position. If the tender “wanders” excessively, lower the outboard so that the skeg is just in the water to add drag for stability.
- When towing, tow only at slow speeds. NEVER tow at planing speeds or above.
- Never tow a tender with people on board.
- When towing, use a tow rope of sufficient strength and length. Consult a dealer for help.
- Consider rigging a release line or sharp knife should it become necessary to release the tender in an emergency.

**WARNING**

**Recoil Hazard: Towing the tender produces stresses to the hardware and tow line. Hardware or line failure can cause a dangerous recoil that can injure people or damage the boat and/or tender.**

**NOTICE**

*If you elect to tow your tender, your boat becomes a tow boat, and the tender becomes a towed boat, which requires appropriate lighting and markings while underway. See the USCG NAVREGS for specific requirements.*

## WATER SPORTS

**WARNING**

**Control Hazard: It is unlawful to participate in water sports while under the influence of alcohol or other drugs.**

Some boats are not designed or recommended to be used for water sports. Use boats equipped with a ski-tow eye or other specially designed line attachment device to pull persons or equipment engaged in a water sport.

Water sports may include, but are not limited to, any activity performed in the water such as swimming, diving, snorkeling, knee boarding, tubing, skiing, parasailing, kiting, gliding or any activity using a device that may be pulled or pushed by a boat.

Check with local and state authorities or water sports clubs and affiliations for additional information.

## PLATFORM DRAGGING

Every year tragic deaths occur from the negligence of unsafe boating and dangerous activities.

**NOTICE**

*It is UNLAWFUL to be on or holding on to the boarding platform, swim deck, swim step, swim ladder or any portion of the exterior of the transom at any time while the boat is running or underway in any direction and at any speed.*

**WARNING**

*Personal Injury Hazard: Body, teak or platform dragging is extremely dangerous and can be fatal. Never hold on to the transom of a boat while in the water when the boat is running or underway.*

- *Do not use the boarding platform or ladder for any purpose other than boarding the boat or entering the water.*
- *Do not use the boarding platform or ladder while the engine is running.*
- *Do not swim under the boarding platform when the engine is running.*

These dangerous and even fatal activities can lead to any or all of the following, as well as other dangers not listed here:

- Carbon monoxide poisoning
- Severe injury from a rotating propeller
- Drowning or entrapment under the water

## WATER SPORTS GUIDELINES

### Boat Operator, Occupants and Participants

The following water sports guidelines only cover the general conditions that frequently arise. The participants must respond to the constantly changing weather and the conditions of the sea by using reasonable and safe judgment in light of the circumstances.

- Always ensure that all water sports participants and occupants of the boat, especially the operator, are fully aware at all times of the participants' condition and location in the water, as well as the surrounding environment.
- Make safety the primary concern of all involved during the activity. Only allow safe and capable participants to engage in the activity.
- The boat operator and water sports participants must always know their limitations in the activity and never exceed them.
- Never perform water sports in or near:
  - Congested areas
  - Restricted areas
  - Navigation or other waterway markers





- Other boats
  - Other water sports participants
  - Obstructions in the water
  - Shorelines
  - Shallow water
  - Hazardous weather conditions
  - Hazardous waterways, rapid moving water, dams, spillways, etc.
  - Areas or times of restricted visibility
  - Hours between sunset and sunrise
  - Locations too far from shore that could hinder immediate rescue or emergency help if needed
- Always engage in water sports activities in safe waterways only.
  - Always attach the water sports tow rope to approved attachment points on the boat.
  - Never jump from a boat that is moving at any speed, and do not enter or exit the water when the engine is running.
  - Never use different length ropes simultaneously for water sports activities.
  - Always make sure that participants know and use approved skiing hand signals and common skiing courtesies.
  - Before starting, always agree to speed and communication hand signals between the boat operator, spotter/observer and participants.
  - Before starting, always inspect the water sports equipment and tow eye, tow point and tow line for safe operating condition, or damage that may lead to failure.



## Know Water Sports Hand Signals

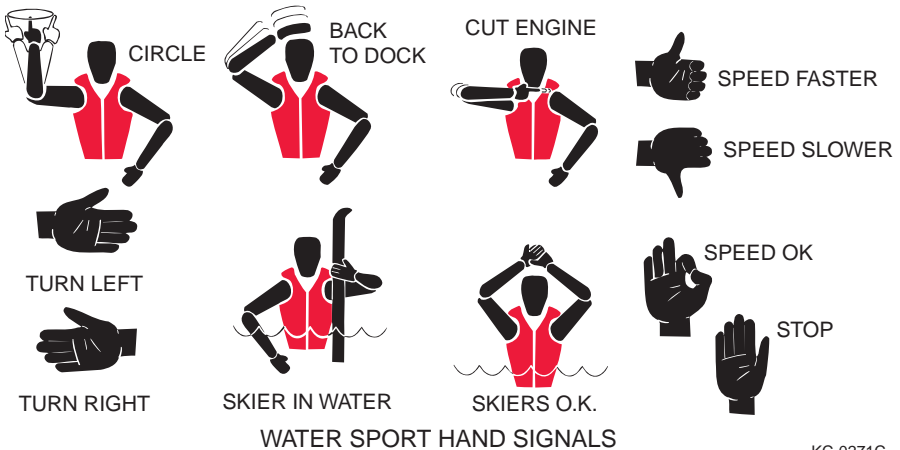

KC-0271C

## Boat Operator Specific Guidelines

The following guidelines are for the boat operator while a participant is in the water.

- Always have a “spotter” (designated observer) other than the boat operator on board to ensure the safety of the participants in the water and provide communication to and from the boat operator and the participants.
- Always turn the engine off from a safe distance when approaching participants in the water and allow them to reach the boat. Never run the engine near a person in the water.
- Never operate the boat in reverse to retrieve anyone in the water.
- Always return immediately to a fallen water sports participant. Always approach the participant on the operator’s side while keeping the participant in view from a direction opposite the wind or seas.
- Never drive directly at a person in the water or directly behind another boat.
- Always maintain a safe distance from people and objects in and on the water.
- Always look in the direction you plan to turn before turning the boat to pick up a fallen skier.
- Never retrieve any object from the water while the engine is running.



- Always keep the skier in view when the skier is entering or exiting the boat.
- Always watch the skier as the line begins to tighten (in case the rope wraps around ski or skier).
- Always look ahead before starting.
- Always start from a safe place with good forward and peripheral visibility.
- Always check direction of steering before starting, ensuring that the boat steers straight.
- Always be aware of what is occurring in front of the boat, and of a participant's condition.
- Always display a "skier down" flag whenever a skier is in the water and not skiing.
- Always follow the approved towing pattern for the waterway in which you are operating.

### **Additional Guidelines for Participants in the Water**

The following guidelines are for the water sports participant.

- Never participate in water sports if you cannot swim.
- Always wear a bright-colored USCG-approved activity life jacket at all times. Wear suitable protective clothing or gear and/or a wet suit to prevent impact injuries, abrasions and hypothermia.
- Never approach or enter the boat if the engine is running.
- Always avoid the boat's propeller. Even when the propeller is not rotating, its sharp edges can cause serious injury.
- Never put any part of your body through the handle of the ski line or wrap the line around any part of your body.
- Never enter the water from a boat that is running or moving at any speed.
- Always indicate that you are clear of the boat prior to the operator starting the boat or putting the boat into gear and tightening the rope.



### **Using the Boarding Platform/Ladder**

**⚠ WARNING** *Personal Injury Hazard: Always turn the engine off whenever anyone is in the water near the boat.*

To board, carefully deploy and use the boarding ladder if available. You may also pull yourself onto the boarding platform to enter the cockpit of the boat. Boats equipped with a boarding platform have a few extra precautions to be aware of:

- NEVER allow anyone on the boarding platform or in the water near the platform while the engine is running.
- NEVER attempt to surf on or off the platform while the engine is running.
- NEVER “platform drag” or touch the boarding platform from the water while the engine is running.
- NEVER exceed the weight capacity of the boarding platform. All boarding platforms have weight limits. If there is no capacity decal, ask the dealer.
- Boarding platforms may be wet and slippery. Advise passengers to use caution and any available handholds when using the platform. Never apply wax to the working deck portion of the platform.
- If the boarding platform is equipped with a ladder, be sure the ladder is fully retracted and secured before operating the boat.
- If the boarding platform is removable, be sure it is properly secured before operating the boat.

## Section 3

# BOATING REGULATIONS AND YOUR RESPONSIBILITIES

The U.S. Coast Guard (USCG) is the federal authority on U.S. coastal and inland waterways, but state and local regulations may exist that exceed USCG regulations. The purpose of all these regulations is to assist the boating public and maintain navigational order on waterways.

Many state equipment requirements go beyond USCG requirements. Contact state and local boating authorities for further information. Equipment requirements for coastal and inland waters differ. Check with local authorities or the USCG for further information about coastal water requirements.

Boating regulations are enforced by USCG, state and local authorities. Operators/owners are subject to marine navigation regulations for both federal and state waterways. Operators/owners must comply if enforcement officers signal them to stop the boat or if they ask to board the boat.

Many USCG, state and local resources are available. For additional and current information on regulations, safety and navigation, contact the local USCG unit or local marine authority.

See the References and Contact Information section of this manual for a list of resources.

## BOAT OWNER / OPERATOR RESPONSIBILITIES

As a boat owner/operator, understand and be aware of USCG federal regulations as well as state and local regulations where operating the boat. Boating regulations include, but are not limited to, boat regulations, boat equipment regulations and navigational regulations.

Operators/owners must have on board at all times all mandatory safety and boat equipment as regulated by the governing authorities. All equipment must be maintained in proper working order.

## SAFETY

Boat owners/operators are legally responsible for their safety, the safety of their passengers and the safety of other boaters. In addition, they are responsible for the operation and navigation of the boat under all operating conditions. The boat must be in compliance with USCG safety equipment regulations.



## REGISTRATION

The USCG requires that all power boats operated on the navigable waters of the United States be currently registered in the state in which they are principally used. Many states require current registration in that state whenever boating on waters within their state boundary. Always contact state boating authorities (and authorities in neighboring states) for registration information on boats and trailers.

Registration numbers must be current and clearly displayed on the boat according to the defined regulations. Registration certificates must be current and on board at all times.

State and local authorities may require additional registration for boating on certain waterways. Check with state and local authorities for additional registration information.

For more information visit:

- U.S. Coast Guard Office of Boating Safety:  
<http://www.uscgboating.org>
- National Association of State Boating Law Administrators:  
<http://www.nasbla.org>

## INSURANCE

Boat owners are legally responsible for any damage or injury caused when they operate the boat when an accident or collision occurs. They are also legally responsible even when someone else operates the boat and causes damage or injury. Individual states have laws detailing minimum insurance needs. Contact the insurance agent to verify the type of insurance needed BEFORE operating the new boat.

## REPORTING ACCIDENTS

The USCG requires the owner/operator of a boat involved in an accident to report the incident to the proper marine law enforcement agency for the state in which the accident occurred. If a person dies or disappears as a result of a recreational boating accident, the boat owner/operator must immediately notify the nearest state boating authority. If a person dies or has injuries requiring more than first aid, the owner/operator must file a formal report within 48 hours of the accident. An owner/operator has 10 days to file a formal report for accidents exceeding \$500 in property damage or complete loss of the boat. Go to <http://uscgboating.org/recreational-boaters/>, Accident Reporting, for information and form download.



## BOATING UNDER THE INFLUENCE



KCB-0011

Federal and state laws prohibit the operation of a boat while under the influence of alcohol or drugs, and authorities actively enforce these regulations. If the operator's blood alcohol content is at or above the legal limit, violators are subject to civil and criminal penalties and imprisonment. Operating a boat under the influence can also result in a loss of motor vehicle driving privileges.

Alcohol and drugs slow reaction time and affect judgment. This type of impaired operation may result in death or severe personal injury.

Owners/operators are responsible for their passengers, including alcohol and drug use and onboard behavior.

Regulations and penalties for operators and passengers may vary from state to state. Contact local and state boating authorities for specific information.

## OPERATOR'S LICENSE AND EDUCATION

This manual does not provide complete training on all aspects of boating safety, operation or regulations. Boating authorities highly recommend that all boat operators and passengers seek additional training in boating safety and seamanship from a USCG-approved course.

Some states require youths 16 years of age and younger to complete a boating safety course before operating any boat. Many others require operators under the age of 18 to be licensed in small boat operation.

Check with state and local authorities for requirements of an operator's license, certificate or training before you or anyone operates the boat.

See the References and Contact Information section of this manual for a list of some of the agencies and organizations that offer water/boating safety courses, first aid/CPR, or other recommended training and/or information.

## OPERATION BY MINORS

Minors must always be supervised by an adult whenever operating a boat. Many states have laws regarding the minimum age and licensing requirements of minors. Regulations may vary from state to state. Contact local and state boating authorities for specific information.



## EMERGENCY ASSISTANCE

An operator seeing a distress signal or suspecting a boat is in trouble must assume it is a real emergency and render assistance immediately. By law, the operator in charge of the boat is obligated to provide assistance to any individual in danger if such assistance can be provided safely. Failure to render assistance can result in a fine and/or imprisonment. The 1971 Boating Safety Act grants protection to a “good Samaritan” boater providing good-faith assistance, and absolves a boater from any civil liability arising from such assistance.

## NEGLIGENT OPERATION

Federal law prohibits the negligent or grossly negligent operation of a boat and/or interference with the safe operation of a boat so as to endanger lives and/or property. Some actions that may constitute grossly negligent operation (criminal offense) are:

- Operating a boat in a designated swimming area
- Excessive speed in the vicinity of other boats or in regulated waters
- Hazardous waterskiing or other water sports practices
- Bow riding, or riding on a seatback, gunwale, boarding platform or transom
- Operating a boat while under the influence of alcohol or drugs (severe penalties may be imposed for boating under the influence [BUI])

Other actions that constitute negligent operation, such as, but not limited to:

- Failure to use handhold
- Overloading or improper loading
- Using a boat in weather or sea conditions beyond the intended design of the boat or beyond the skill or experience of the operator
- Continued operation with operator’s visibility blocked or impaired
- Modification to boat causing an unsafe operating condition

## RESTRICTED AREAS

### SECURITY ZONES

Operators must avoid all waterways and areas that are restricted, such as military installations, power plants and petroleum and chemical facilities. Because of the threat of terrorism, the U.S. Coast Guard has implemented and will continue to enforce strict limits on boats near U.S. Navy and U.S. Coast Guard ships and other potential targets.





## NAVAL VESSEL PROTECTION ZONES

Do not approach within 100 yards of any U.S. Naval vessel. Slow to minimum speed within 500 yards of any U.S. Naval vessel. Operators needing to approach within 100 yards to ensure a safe passage in accordance with the Navigation Rules must contact the U.S. Naval vessel or the U.S. Coast Guard escort vessel on the boat's VHF radio (channel 16) for authorization.

## COMMERCIAL SHIPPING SAFETY ZONES

Do not operate the boat near cruise liners or certain waterfront commercial installations such as ferry terminals. Observe and avoid all security zones and commercial port operations.

## BRIDGES AND SHIPPING CHANNELS

Do not stop or anchor beneath bridges or in shipping channels. Operators doing so should expect to be asked to move and/or be boarded by law enforcement officials. Anchoring in these areas is dangerous for the operator and others on the water.

## AMERICA'S WATERWAY WATCH

Boat operators can help the U.S. Coast Guard in keeping waterways and coastal installations safe and secure. Boat operators can do this by participating in America's Waterway Watch (AWW). Boaters reporting suspicious activities to AWW should call 877-24WATCH if noticing suspicious activity or behavior on or near the water.

In cases of immediate danger to life or property, call the U.S. Coast Guard on channel 16 VHF-FM or dial 911 for emergencies.

## FISHING

Fishing can be very exciting and distracting for the operator when the action gets intense. Operators must always be conscious of the primary responsibility, which is the safe operation of the boat and the safety of passengers and other boats in the area.

Always make sure the helm is properly manned and is never left unattended while trolling. If the boat is equipped with a tower, exercise caution and sound judgment whenever someone is in the tower. Remember, weight in the tower raises the boat's center of gravity and the boat's motion is greatly exaggerated for the person in a tower.



An operator fishing in an area that is crowded with other fishing boats may have difficulty following the rules of the road. This situation can become especially difficult when many boats are trolling. Being courteous and exercising sound judgment is essential. Avoid trying to assert the right-of-way and concentrate on staying clear of other boats. Prevent the boat from becoming entangled in lines and from cutting into lines. Also keep in mind that fishing line wrapped around a propeller shaft can damage seals in the engine lower unit.

There is currently a tremendous drain on our fishing resources. Excessive fishing and hunting, as well as pollution, have strained the fish and game population. Help out by keeping only what you will eat; practice catch-and-release and obey bag limits.

## MONOFILAMENT FISHING LINE

Wildlife can experience harm from becoming entangled in or ingesting monofilament fishing line if it is left in the water or on shore. Line in the water can also endanger swimmers and divers and become tangled in boat propellers, causing damage. It can last for years in water, posing a threat for a long time. Fishing line can remain a problem even if put in the trash, because birds can take it from an open bin and become entangled or it can entangle wildlife at landfills.

Many states and private boating/wildlife organizations sponsor programs to collect used line for recycling into new products. Operators who carry used line or happen upon it while boating can dispose of it in recycling bins located at many marinas, launches, tackle shops and state service centers.

## MARINE ANIMALS IN DISTRESS

If encountering a beached, stranded or entangled marine mammal (whales, dolphins, porpoises, seals, and sea lions) or other animals, such as sea turtles, that need help in or near the water, go to: [www.nmfs.noaa.gov/pr/health/report.htm](http://www.nmfs.noaa.gov/pr/health/report.htm) for resources in your area.

If witnessing others harassing or otherwise endangering wildlife, call the local authorities or 911. Take photos or video if possible.

## WAKE

Boat owners/operators are responsible for the wake the boat creates. Regulations may vary from state to state. Contact local and state boating authorities for specific information, as owners/operators may be responsible for any damage or injury their wake causes. Always be alert for no-wake zones and be courteous of others while boating. Excessive and unexpected wakes can cause dangerous and even life-threatening situations.



## NOISE

Boat owners/operators are responsible for the noise the boat creates. Many state and local boating authorities enforce noise limits that may restrict engine noise, radio volume or even loud talking. Regulations may vary from state to state. Contact local and state boating authorities for specific information.

## SPEED

Boat owners/operators are responsible for maintaining the boat under control at a safe speed. Many state and local boating authorities enforce speed limits. Regulations may vary from state to state. Contact local and state boating authorities for specific information.

## SHALLOW WATER BOAT STABILITY

Boat designs for flats, bays, poles and skiffs are very similar. Because of the unique requirements for a shallow draft, stability issues can arise under certain conditions, especially during quick turns. Take time to learn the characteristics of the boat alone and in open water away from other boaters. Make gradual increases in speed and radius to get the feel of stability under various conditions and be ready to make adjustments quickly. Slow down when boating with passengers to avoid possible ejection from the boat.

## PROTECTING THE ENVIRONMENT

Our lake, river and ocean resources must be protected to be enjoyed by future generations. Boat owners/operators are responsible for protecting the natural environment and wildlife by keeping waterways clean.

U.S. waters are covered by several water pollution regulations administered by numerous federal and state agencies. Laws vary between local, inland, coastal, ocean and international waters. Laws can be enforced by local and state authorities as well as the USCG. For recreational boats, U.S. Federal Water Pollution Control, Oil Pollution Control and Refuse Acts cover U.S. waters, and the MARPOL treaty covers international waters. In any case, pollution prevention centers around three areas:

- Sewage pollution
- Garbage (solid waste) pollution
- Oil pollution



# BOATING REGULATIONS AND YOUR RESPONSIBILITIES

As a boater, make it a point NOT to dump or discharge ANYTHING into waters and tell passengers to respect this rule. Return all trash after boating and dispose of it properly on shore.

## DISCHARGE OF OIL PROHIBITED

The Federal Water Pollution Control Act prohibits the discharge of oil or oily waste into or upon the navigable waters of the United States, or the waters of the contiguous zone, or which may affect natural resources belonging to, or under the exclusive management authority of the United States. If such discharge causes a film or discoloration of the surface of the water, or causes a sludge or emulsion beneath the surface of the water. Violators are subject to substantial civil penalties and/or criminal sanctions including fines and imprisonment.

KC-6020

## WASTE MANAGEMENT PLAN (WMP)

All oceangoing boats 40 feet or more in length equipped with a galley and berthing must have a written waste management plan onboard covering waste collection, handling and disposal. For details, go to [www.boatus.org/clean-boating/recycling/waste-management-plan/](http://www.boatus.org/clean-boating/recycling/waste-management-plan/).

### THE DISCHARGE OF ALL FORMS OF PLASTIC INTO ALL WATERS IS PROHIBITED

#### THE DISCHARGE OF ALL GARBAGE IS PROHIBITED

Into the navigable waters of the United States, and into all other waters except as specifically allowed.

**ALLOWED:** 3 to 12 nautical miles from land – Food waste ground to pass through a one-inch mesh screen.

**ALLOWED:** 12 or more nautical miles from land – Food waste ground as above, and waste water, and cleaning agents, en route as far from shore as practicable, that are not harmful to the marine environment.

#### MARPOL ANNEX V - SPECIAL AREAS

**GULF OF MEXICO & CARIBBEAN SEA** – Food waste en route ground to pass through a one-inch mesh screen.

**WESTERN CARIBBEAN REGION** – Discharge of all garbage prohibited within 12 nautical miles of land.

Any person who violates the above requirements is liable for civil and/or criminal penalties and regional, state and local restrictions on garbage discharges may also apply.

REPORT ILLEGAL DISPOSAL TO THE U.S. COAST GUARD ON VHF RADIO CHANNEL 16

KCB-0057

## MARPOL TREATY

The USCG enforces the International Convention for the Prevention of Pollution from ships, commonly referred to as the MARPOL Treaty (MARine POLLution). This treaty prohibits the overboard dumping of all ship-generated plastics, chemicals, garbage and oil. Contact the USCG for further information.



## AQUATIC INVASIVE SPECIES (AIS)



KC-6027

*Stop aquatic hitchhikers.* Waterways are under assault by nuisance invasive species transported from one body of water to the next by ships and boats. Recreational boaters can help stop the spread of AIS with thorough equipment inspection and cleaning. Many waterways popular with trailer boaters have mandatory state or local inspection and decontamination centers.

Stop the transport of invasive species:

- REMOVE plants, fish, animals and mud from boots, gear, boat trailer and vehicle.
- CLEAN the gear before entering and leaving the recreation site.
- DRAIN bilge, ballast, wells and buckets before leaving the area.
- DRY equipment before launching the boat into another body of water.
- DISPOSE of unwanted bait in a sealed container.

Inspection, rinsing, flushing or high-pressure washing removes AIS, while hot water kills AIS. In the absence of hot water or high pressure, rinsing with tap water and completely drying will help prevent the spread of AIS. For more information visit: <http://StopAquaticHitchhikers.org>.

## PAINTS

Boat owners are responsible for the environmental regulations that may govern the use of antifouling paint. If the boat is kept in water where marine growth is a problem, the use of antifouling paint may reduce the growth rate. Regulations may vary from state to state. Contact local and state boating authorities for specific information.

## CLEANING AGENTS

Boat owners are responsible for the environmental regulations that may govern the use of cleaning agents. There are many “green” cleaner choices available for most any material on the boat. If using household cleaners, use them sparingly and never discharge them into waterways. Do not mix cleaners and be sure to use plenty of ventilation in enclosed areas. Avoid using chlorine, solvents and products that contain phosphates, as well as non-biodegradable or petroleum-based products. Regulations may vary from state to state. Contact local and state boating authorities for specific information.



## EXHAUST EMISSIONS

Boat owners are responsible for the exhaust emissions from the boat. Increased exhaust (hydrocarbon) emissions, which are regulated by the EPA, pollute the water and air. Contact the dealer and the engine manufacturer for more information. Additional restrictions may apply and vary from state to state. Contact local and state boating authorities for specific information.

## ADDITIONAL PROPOSITION 65 INFORMATION

A wide variety of components used on this boat contain or emit chemicals known to the state of California to cause cancer, birth defects and other reproductive harm.

### Examples include:

- Engine and generator exhaust
- Engine and generator fuel and other liquids, such as coolants and oil, especially used motor oil
- Cooking fuels
- Cleaners, paints and substances used for boat repair
- Waste materials that result from wear of boat components
- Lead from battery terminals and from other sources, such as ballast or fishing sinkers

### To avoid harm:

- Keep away from engine, generator and cooking fuel exhaust fumes.
- Wash areas thoroughly with soap and water after handling the substances above.

### **▲ WARNING**

A wide variety of components used on this vessel contain or emit chemicals known to the State of California to cause cancer and birth defects and other reproductive harm.

#### **EXAMPLES INCLUDE:**

Engine and generator exhaust.  
Engine and generator fuel, and other liquids such as coolants and oil, especially used motor oil.  
Cooking fuels.  
Cleaners, paints and substances used for vessel repair.  
Waste materials that result from wear of vessel components.  
Lead from battery terminals and from other sources such as ballast or fishing sinkers.

#### **TO AVOID HARM:**

Keep away from engine, generator and cooking fuel exhaust fumes.  
Wash area thoroughly with soap and water after handling the substances above.

California Health & Safety Code 25249.5-.13

KC-0206C-B

# Section 4

## EMERGENCIES

Be prepared to deal with emergencies before they happen. Try to formulate a plan for each type of emergency in advance in order to make decisions quickly and without hesitation. Precious moments lost can mean the difference between losing and saving a life.

Before operating the boat, review *Safety in Section 2*.

### FIRST AID / MEDICAL EMERGENCIES

Every second counts toward preventing injury or death in case of a medical emergency. Boaters must have proper training and take necessary preventive measures to properly assist in times of need. Carrying an adequate and current first aid kit is critical in the immediate response and care of someone in need of medical attention. Always have dry blankets readily accessible to help prevent hypothermia. For additional information on medical, first aid and safety training such as CPR, contact your state and local authorities, or visit the Red Cross website:

<http://www.redcross.org>.

### EMERGENCY PREPARATION CHECKLIST

In addition to a safety equipment list, have an emergency checklist on board to assist in times of emergency. Use the following topics as a guideline to develop a list of emergency procedures and instructions for the use of visual and audible distress signaling devices, radios, first aid kits and all related information that could assist you or others in the event of an emergency.

### USING DISTRESS SIGNAL DEVICES AND CALLING FOR HELP

Ensure all passengers understand how to operate all onboard visual and audible distress signaling devices and communication equipment. Keep all distress signaling devices and communication equipment in a readily accessible area and within immediate reach at all times.

An emergency can occur when you least expect it. Be sure you and your passengers know how to use all types of distress signaling devices.

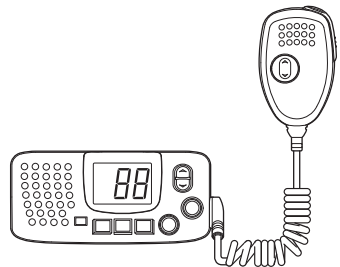

KC-0246-B



See the Markers, Warnings and Advisories section of this manual for more signaling devices.

Seconds count during emergencies. Knowing the proper way to use the distress signaling devices aboard the boat can help save lives.

- **MAYDAY radio call** – A mayday call is reserved for life-threatening situations, such as fire, severe weather or sinking, where lives are in imminent danger or the boat is in danger of sinking. Start the broadcast clearly and calmly with **“Mayday - Mayday - Mayday.”**
- **PAN-PAN (pahn-pahn) radio call** – A pan-pan call is used for urgent but non-life-threatening situations where there is no immediate danger to lives or the boat, such as a loss of steering control or taking on water of any amount. Start the broadcast clearly and calmly with **“Pan - Pan - Pan.”**
- **Securite (se-cure-ih-tay) call** – A securite call is used for non-life-threatening situations to notify authorities and others in the vicinity of important navigation and weather alert calls. Start the broadcast clearly and calmly with **“Securite - Securite - Securite.”**

In an emergency situation the responder needs to know four important pieces of information:

- The exact nature of the emergency and an assessment of the severity
- Number of people on board
- The location (navigation marker, visual reference or GPS coordinates in open water)
- What the boat looks like (hull and top colors, unique features, flags, etc.)

For additional information on the safe and proper use of distress signaling devices and the safe and proper use of emergency communication equipment, contact state and local authorities. Additional information can be found on the USCG website:

<http://www.uscgboating.org>.

## REQUESTING ASSISTANCE (NON-DISTRESS CALL)

If a boater contacts the USCG on Channel 16 VHF-FM or Channel 70 DSC regarding a non-distress situation, the USCG will offer to contact any assistance provider (commercial or friend) the boater requests or will issue a Marine Assistance Request Broadcast (MARB) if the boater has no preference of service.





## LAW OF SALVAGE

If boaters require assistance while cruising in the Great Lakes, coastal or ocean waters, they should use caution **before** allowing any towing company or private agency to pass a line to the boat. The law of salvage says, among other things, “...any vessel, if rendered assistance from a towing company or private agency, can be forced to relinquish a portion of the vessel’s worth for the assistance received.” While this is very rare with recreational boats, it can happen.

Before taking the line boaters must establish that they do not agree to any salvage rights and wish to be assisted on a contract basis. Boaters must then establish the contract price and payment terms. Boaters should accept the tow line only when the captain of the company/agency acknowledges the contract price and payment. Most tow companies are reputable and post terms and pricing on their websites.

If boating in the Great Lakes, coastal or ocean waters, it is a good idea to have a membership in a national towing service. This membership can significantly reduce the costs of towing if ever needed.

## FIRE AND EXPLOSION



### WARNING

**Fire/Explosion Hazard: Gasoline is extremely flammable and highly explosive under certain conditions.**

- Do not smoke or allow open flames or sparks nearby when refueling.
- Do not store fuel in any containers or compartments which are not designated for fuel storage.
- Static electricity can be generated while fueling and can cause a fire or explosion. To prevent electrostatic spark when refueling, make sure the nozzle is in contact with the fill pipe at all times.
- Avoid damaging fuel lines and connectors and make sure fuel does not contact hot engine parts.
- Do not confuse the fuel fill deck plate with the water or waste fill plates, if equipped. All deck plates are properly labeled. If fuel is accidentally pumped into any other deck plate, do not attempt to pump it out. Water and waste pumps are not designed to pump fuel and a fire or explosion could result. Contact the dealer to have the fuel professionally removed.
- USCG-approved fire extinguishers are required on all Class I, II and III boats.



A fire or explosion may occur when least expected. The decision to abandon the boat or stay to fight the fire is difficult and depends on many factors. Formulate a fire plan in advance to make that decision quickly and without hesitation. Keep in mind the following guidelines:

- Many fires are the result of gasoline and oil accumulating in the bilge, careless fueling practices and electrical problems. In the event of a fire, try to stop the boat and turn off the engine as quickly and safely as possible. Immediately use a fire extinguisher at the base of the flames in a sweeping motion to reduce or extinguish the fire. Ensure that all passengers are safe from immediate danger and are wearing life jackets. If the fire is located in the engine compartment (if equipped), make sure the bilge blower (if equipped) is off and do not open the engine cover.
- Once the fire is extinguished, check for other immediate fire threats and personal injuries and call for assistance immediately.
- If you are unable to easily extinguish the fire, or if the fire is uncontrollable, attempt to get yourself and all passengers off the boat and into the water. If possible, ensure that all passengers are wearing life jackets or have access to one by the time they are in the water. Before leaving the boat, if possible, verify that there is no immediate danger of fuel sitting or burning on the water's surface where you and your passengers will be floating. Immediately swim to a safe position upwind from the boat and use distress signals to get assistance.



KC-0074C-A

## MAN OVERBOARD (MOB)

A high percentage of boating fatalities are the result of people falling overboard, many of whom were not wearing life jackets. If someone falls into the water unexpectedly, react quickly, as every second counts toward preventing injury or death. Keep these guidelines in mind:

- Brief passengers before leaving the dock on the proper procedures should someone fall overboard. Add this briefing to the passenger safety equipment overview.
- At the first sign that a person has fallen overboard, loudly yell “man overboard” and state which side of the boat such as “man overboard — port!” In heavy seas, throw a floatable item toward the MOB as quickly as possible to serve as a marker.



- The operator should immediately reduce speed and determine whether or not to come to a full stop or circle around.
  - If stopped, throw a flotation device (Type IV is best, but any can be used) to the victim, shut down the engines, and throw the victim a line if necessary.
  - If circling around, assign one passenger to throw a flotation device as a marker, keep the victim in sight and continuously point to the victim. Carefully navigate back to the victim, staying at a safe distance, and position the boat safely to retrieve the victim. Keep current, wind and waves in mind so the victim drifts toward the boat. Shut down the engines and throw the victim a line if necessary.
- Move passengers to the rescue side of the boat to assist the victim back into the boat.
- Avoid going into the water to assist the victim unless there is no other way to retrieve the victim. If a rescuer must go into the water, the rescuer should be wearing a life jacket. The rescuer should also be prepared for the possibility of being pulled under water by the victim if the victim is panicking.

## CAPSIZING AND FLOODING

A boat may capsize or flood when least expected. Formulate a plan in advance in case of capsizing or flooding. Review the following guidelines:

- If the boat capsizes, locate all passengers and guide them to a safe flotation device or the forward hull if the boat is floating upside down.
- If possible, provide life jackets to all persons in the water and assess them for alertness and injuries.
- **STAY WITH THE BOAT!** Climb up on the hull and try to get assistance.
- Do not try to swim to shore, as it can be farther than it appears.

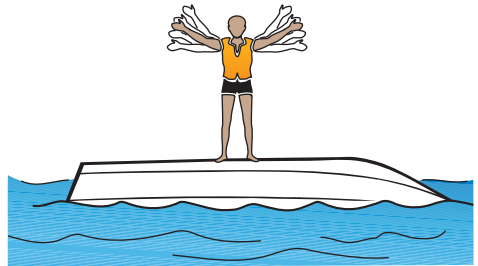

KC-0013C-A

If the boat starts to flood, slow the boat to a safe speed and stop as quickly as possible. Activate the bilge pump(s) immediately. Try to locate the cause of the flooding. If the cause is not readily apparent or not easily corrected, head for shore or shallow water as quickly as possible and call for help.



## RUNNING AGROUND

When a boat runs aground, the stop is usually abrupt. Because passengers are not secured to a seat, abruptly stopping a boat while in motion can cause serious personal injury or even death. First, turn off the engine(s) immediately, locate all passengers and attend to any injuries, calling for emergency assistance as needed. Then, assess the damage to the boat and determine if there are any other immediate threats such as water leaking into the boat, or fuel or flammable materials leaking into the water or inside the boat. Immediately call for assistance if threats exist that could endanger the safety of passengers.

If there are no immediate safety threats to passengers and the boat is not damaged, attempt to propel it away from the obstacle. If the engine or drive system has been damaged and the engine restarts, be aware of excessive vibrations or uncommon noises, which usually indicate damage to the drive system. If this is the case, it is not safe to proceed. Call for emergency or professional towing assistance immediately.

**⚠ WARNING** *Personal Injury Hazard: Use extreme caution when using tow lines and when connecting tow lines to cleats. Death or serious injury could occur when lines and/or cleats fail while they are under extreme tension.*

If the engine restarts and the boat can be navigated safely back to port, proceed slowly to port and be ready to call for emergency assistance if needed. Even if the boat and engine appear to be in good operating condition after running aground, have the boat inspected by a qualified marine technician BEFORE returning it to service. Damage may have occurred that is not obvious to you as an operator.

## DANGEROUS WEATHER

Take special precautions when encountering or operating in dangerous or hazardous weather conditions.

See the Severe Weather section of this manual for additional information.

## ENGINE OR BOAT SYSTEM FAILURE

In the event of an engine or boat system failure and when not in immediate danger, try to troubleshoot or identify the problem before calling for assistance.

See the Troubleshooting section of this manual for additional information.



## ACCIDENTS, COLLISIONS AND GIVING ASSISTANCE

A collision or accident may occur when least expected. Formulate a course of action in advance in case of a collision or accident. Keep in mind the following guidelines:

- If an accident or collision occurs involving the boat, locate all passengers first and verify and secure their safety. Check for injuries and provide all passengers with a flotation device.
- After determining that passengers are not in danger, provide assistance to passengers on the other boat.
- Immediately call for help and then assess the damage to the boats. Render necessary assistance to prevent further damage or personal injury.

The USCG requires the owner/operator of a boat involved in an accident to report the incident immediately to the proper marine law enforcement agency for the state in which the accident occurred.

See the Reporting Accidents section of this manual for additional information.

An operator who witnesses or is aware of an accident or collision while boating must report it immediately and provide assistance.

Operators seeing a distress signal or suspecting a boat is in trouble must assume it is a real emergency and render assistance immediately. After determining that a real emergency exists, call for help immediately and then provide assistance to all passengers to ensure their safety.

## TOWING ON THE WATER

In situations where an operator is asked to tow or be towed for any reason, assess the situation and try to contact a professional towing service or other emergency assistance first.

When encountering a boat in distress, always offer emergency or safety assistance and/or call for assistance

for the distressed parties if necessary. Towing or being towed presents an increased risk of personal injury and boat damage.

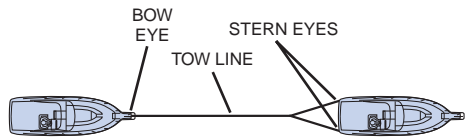

KC-0058-A



### WARNING

**Personal Injury Hazard: Use extreme caution when using tow lines and when connecting tow lines to cleats. Death or serious injury could occur if lines and/or cleats fail while they are under extreme tension.**



Follow these guidelines when towing or being towed:

- Use extreme caution when throwing weighted lines to a boat in distress. When in rough seas, use a light throwing line with a weight secured on the throwing end and a heavier towing line secured to the other end.
- Never attempt to tow a boat larger or heavier than your own.
- Never attempt to tow a grounded, damaged or capsized boat.
- Use a tow line that is rated at least four times the gross weight of the boat being towed.
- Make sure tow lines are in good condition and are free of damage, cuts or abrasions.
- Attach a tow line to the bow eye on the disabled boat. Never attach a tow line to any point on the disabled boat other than the bow eye.
- Attach the tow line to the stern eyes of the towboat. Wrap the tow line with chafing gear where it rubs against the boat or any corners.
- Leave at least two boat lengths between the boats for adequate movement.
- Never allow anyone to be in line with the tow line. If the line breaks or pulls free, dangerous recoil could occur, resulting in severe injury or death to anyone in its path.
- Adjust the tow line to match wave action. Keep the boats on the crest or in the trough of the waves at the same time. In protected, calm waters, shorten the line for better handling.
- Tow at moderate speed, allowing for adverse wind and wave conditions.
- Have the operator of the towed boat steer with you if possible.
- Have a person on the tow boat watch the disabled vehicle and, if necessary, be available to signal the operator of the disabled boat.

Check with local and state authorities prior to towing for additional regulations and restrictions on towing other boats or equipment.

## HURRICANE AND SEVERE WEATHER PREPAREDNESS

If keeping the boat in a region susceptible to hurricanes or severe weather (such as in the Great Lakes), have a well-thought-out plan for the boat long before the season starts. Consider the following:

- Boaters new to the area should talk to neighbors and local officials on what to expect.
- Boaters should talk to the dealer and marina about supplies, equipment and services available.



- Assemble the boat, contacts and insurance information and copy documents for safekeeping.
- If keeping the boat on the water, prepare a hurricane mooring package with extra lines, fenders and chafing protectors, as it is usually the boat owner's responsibility to provide mooring gear in a marina. Plan on doubling the normal lines (bow, stern and spring) and fenders as a minimum. Remember, once a hurricane watch is posted, the local supply of lines and fenders will be quickly depleted.
- Remove electronics, canvas and loose items such as fighting chairs.
- Remove flammable, explosive or hazardous materials.

## PROTECTING THE BOAT FROM THEFT

Thefts of boats, propulsion units and electronics are on the rise due to the high values and easy resale. While thieves still target boats on trailers at homes or on lake properties, marinas, storage facilities and dealerships are now being targeted because of the concentration of high-quality outboards and electronics available. Consider the following to make it difficult for thieves:

- Remove expensive electronics or cover with a sturdy, lockable cover.
- Use locking devices on outboard motor mounts and propellers.
- Use security fasteners that require a special tool for removal when mounting devices.
- Survey the marina or storage facility for obvious security lapses. Discuss concerns with personnel or find a new location.
- Talk to neighbors at home or the marina/storage facility and provide them with a cell phone number and other contact information.
- If leaving the boat in the water, install a boat monitoring system with GPS tracking. Many propulsion unit manufacturers now offer this as an option on boats with electronic controls.
- Consult an insurance agent and local authorities for more recommendations.



SECTION

# 4

## EMERGENCIES

This Page Intentionally Left Blank



# Section 5

## OPERATING IN HAZARDOUS CONDITIONS

Before operating the boat, review *Safety in Section 2*.

### SEVERE WEATHER

Getting caught in severe weather can be dangerous and even fatal. Check with local weather stations, the USCG or weather-service broadcasts (162.55 or 162.40 MHz) for the latest conditions. Check the weather not only before you go out on the water, but also periodically while you are on the water. Consult the following websites for weather information:

- [www.weather.com](http://www.weather.com)
- [www.nws.noaa.gov](http://www.nws.noaa.gov)
- [www.navcen.uscg.gov](http://www.navcen.uscg.gov)

Enable National Oceanic and Atmospheric Administration (NOAA) weather alerts on radios, phones and other electronic devices for advance warnings. If weather is approaching, instruct all passengers to wear a life jacket; close all windows, hatches and doors; remain seated; use handholds and seek shelter in a safe harbor.

### STORM CONDITIONS

Take the following precautions if operating the boat in storm conditions:

- Have all occupants wear life jackets.
- Turn on navigation lights.
- Locate and have inclement weather gear and safety equipment ready.
- Mark or identify the boat's position.
- Close all ports, stow all gear and secure any loose equipment on deck.
- Reduce speed and head for port or a safe, easily reachable place.
- Keep a lookout for debris and obstructions in the water.
- When possible, head into the waves at a 45-degree angle. Allowing high waves to strike the side of the boat may cause it to capsize or swamp.
- If losing power, keep the boat headed into the waves by rigging a sea anchor off the bow.
- If a storm cell with lightning cannot be avoided, lower antenna and take down fishing poles.



## **FOG CONDITIONS**

Avoid operating the boat in foggy weather, if possible. Operators encountering fog conditions should return to port immediately. Also, take the following precautions:

- Reduce speed to a safe speed or idle.
- Take bearings and log the course and speed before the fog sets in. Use of a GPS is recommended.
- Have all occupants wear life jackets.
- Assign lookouts to the bow and stern to keep watch and listen.
- While navigating in fog, sound a five-second blast from the horn or whistle once every two minutes to alert other boaters of your position.
- If it is unsafe to continue navigating the boat, quickly find the best position to anchor. Sound a five-second blast from the horn or whistle once every minute while anchored to alert other boaters of your position.

## **REDUCED VISIBILITY**

Natural environments and inclement weather can cause reduced visibility. Storm condition hazards can be compounded by reduced visibility while on the water. Always use common sense and take safety precautions if operating the boat in reduced visibility conditions.

## **COLD WEATHER AND COLD OR FROZEN WATER CONDITIONS**

Avoid operating the boat in cold water or weather conditions, and never operate in frozen or icy waters. Operating in these conditions significantly increases the risk of serious injury or death. Boating in these conditions can lead to cold-water immersion, shock or hypothermia. Weather conditions may hinder emergency rescue or assistance, and cold weather poses potential problems for onboard equipment, as well as the engine. See the *Engine Operator's Manual* and the equipment manufacturer's instructions for operating in cold weather.

## **WATER HAZARDS**

Every waterway poses hazards that operators must be aware of and avoid. These hazards include shallow water, rocks, tree stumps, sandbars and submerged/semi-submerged cables and pipes. Ask local authorities and other boaters for information and consult a marine chart when boating on unfamiliar waters. As a boat operator, try to avoid all hazards, known and unknown.



## AQUATIC VEGETATION/WEEDS

Operating in weeded areas can be hazardous. Aquatic vegetation can be a threat to the boat's drive system. Vegetation and weeds can wrap around the propeller, causing loss of propulsion and steering control. They may also restrict the engine water cooling intake, causing the engine to overheat. Avoid operating in or near vegetation. If restricted because of vegetation, stop the engine. See the *Engine Operator's Manual* for recommendations on the removal of vegetation from the propeller and water cooling intake ports. Be extremely careful and never get into the water when clearing the propeller. Stay out of the water in highly congested vegetative areas, which can severely restrict your mobility and create a life-threatening situation.

### NOTICE

*Vegetation can sometimes be removed by shifting to NEUTRAL, pausing a moment, then shifting to REVERSE to unwind the vegetation from the propeller.*

## DAMS AND SPILLWAYS

The waterways around dams and spillways are extremely hazardous. Dams and spillways are subject to rapid water flow changes, and may have floating and sunken debris in the nearby water. These areas are often marked as restricted, and it is best to always stay clear of them.

## SHALLOW WATER OPERATION



### WARNING

***Collision Hazard: Use caution in shallow water or where underwater/floating objects may be present. Hitting an object at high speed or severe angle can seriously injure people and damage the boat.***

Operating in shallow water presents a number of hazards. Sandbars in narrow inlets are constantly shifting, making it difficult to mark them with buoys. Sandbars are sometimes indicated by waves as they form into breakers when passing over the sandbar. In coastal areas, tides can affect water level as much as 30 feet (9 meters). Check with local marinas or Coast Guard stations for tide tables and current charts.



## MARKERS, WARNINGS AND ADVISORIES

Find out from local authorities if hazards exist in areas where you intend to navigate, and know how these hazards are marked. You must also recognize flag designs that indicate hazards or activities that are present and keep well clear of those areas. Always watch for swimmers and stay clear of all swimming areas, marked or unmarked.



KC-0015C-B

Become familiar with navigation markers, which identify navigable routes and indicate water hazards. Always stay within marked boundaries and steer clear of hazards.

Flags and indicators are markers of potential emergencies and hazards. Become familiar with these flags and indicators. Additionally, understand your responsibilities when operating at these times and in these areas.

## BOAT FLAGS

DIVERS FLAG



USED BY  
RECREATIONAL  
DIVERS -  
INDICATES  
DIVER'S  
POSITION

ALPHA FLAG



WORLDWIDE VESSELS  
ENGAGED IN DIVING  
OPERATIONS - DOES  
NOT INDICATE  
DIVER'S POSITION

DISTRESS FLAG



INDICATES  
FELLOW  
BOATER IS IN  
NEED OF  
ASSISTANCE

SKIER DOWN FLAG











INDICATES  
SKIERS IS DOWN

KCB-0013

Storm warning advisory flags and indicators alert boaters to impending weather conditions. Become familiar with these flags and indicators and understand the potential hazards associated with operating in these conditions.



## HARBOR FLAGS AND INDICATORS

DAYTIME WARNING	DESCRIPTION	NIGHTTIME WARNING
	<b>Small Craft Advisory</b> - Winds greater than 18 knots, sustained for two hours or more or hazardous wave conditions. Following a storm, hazardous wave conditions can persist long after the high winds have subsided.	
	<b>Gale Warning</b> - Sustained winds (2 or more hours), of 34-47 knots.	
	<b>Storm Warning</b> - Sustained winds of 48 knots or greater.	
	<b>Hurricane Warning</b> - Forecast winds of 64 knots and above. Displayed only in connection with a hurricane.	

 Actual Signal in red

KC-0371C



SECTION

# 5

## OPERATING IN HAZARDOUS CONDITIONS

This Page Intentionally Left Blank

## Section 6

# NAVIGATION RULES AND AIDS

Before operating the boat, review *Safety in Section 2*.

The following information outlines basic navigational rules. Boating regulations are enforced by USCG, state and local authorities. You are subject to marine navigation regulations for both federal and state waterways. For more information, contact the USCG, state and local marine authorities. The navigational rules for U.S. waterways can be found in the “Navigational Rules” publication. This publication can be found at most marine supply stores, or you may contact the USCG or visit:

[www.navcen.uscg.gov](http://www.navcen.uscg.gov) to view or download the publication.

Any boat 39 feet (12 meters) or longer must have a copy of the “Navigational Rules” publication on board at all times. Failure to have this document on board can result in penalties and/or fines.

## NAVIGATION RULES

The USCG Navigation Rules and Regulations Handbook is a compendium produced by the USCG Navigation Standards Branch of the:

- International Regulations for Preventing Collisions at Sea
- Inland Navigation Rules and their respective technical annexes
- COLREGS Demarcation Lines
- Vessel Bridge-to-Bridge Radiotelephone Regulations
- Vessel Traffic Management Regulations
- Various other pertinent provisions of the U.S. Code and Code of Federal Regulations regarding compliance and penalties associated with the Navigation Rules

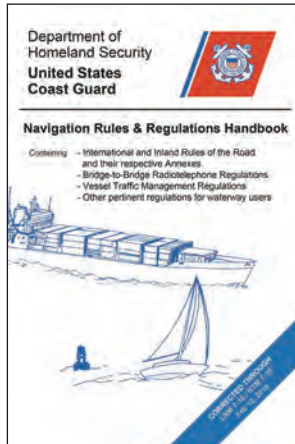

KCB-0058

If the size of the boat requires that keeping a copy of this handbook on board for reference, all operators should familiarize themselves with the contents annually. To obtain a copy of this handbook, go to <http://uscgboating.org>.

## RIGHT-OF-WAY

Boats with less maneuverability have right-of-way over more agile boats. You must stay clear of a boat with right-of-way. Examples of boats with right-of-way are:

- Boats aground or not under command
- Boats with restricted maneuverability
- Boats engaged in fishing
- Non-motor boats (having no power propulsion), i.e., rowboats, paddle boats, canoes and sailboats

Small pleasure boats must yield right-of-way to large commercial boats in narrow channels. A boat with right-of-way is sometimes referred to as the privileged boat.

## THE GENERAL PRUDENTIAL RULE

The general prudential rule regarding right-of-way is if a collision appears unavoidable, neither boat has right-of-way. Both boats must act to avoid collision.





## NAVIGATIONAL LIGHTS AND NIGHT OPERATION

Navigational lights alert other boats to your presence and course, especially when operating at night or in restricted visibility conditions.

Regulations require that navigational lights be clearly lit and properly displayed at all times between sunset and sunrise, and always when operating in reduced visibility. Where applicable, lights must appear on the sides, stern, masthead and all-around positions.

All navigational rules apply at night, but speed is restricted on many waterways. Night boaters must operate at a slow, safe speed and stay clear of all boats, regardless of which boat has right-of-way.

Protect your night vision by avoiding bright lights. If possible, have a passenger help keep watch for other boats, water hazards and aids to navigation.

The size, speed and direction of other vessels are determined at night by white, green and red running lights.

- A green light indicates the starboard side of the boat. Generally, if you see a green light on another boat, you have the right-of-way. Hold your course.
- A red light indicates the port side of the boat. Generally, if you see a red light on another boat, they have right-of-way and you must yield your course.

## AUDIBLE SIGNALS

It is not necessary to sound a signal every time a boat is nearby. It is typical for commercial boat operators to signal their intention, using a whistle, horn or bell, to avoid potentially confusing or hazardous situations. Privileged boat operators customarily signal first, then the yielding boat operators return the same signal to acknowledge they understand and will comply. Use the danger signal (five or more short, rapid blasts) if intent is not clear.



Use the following signal blasts early enough so other boaters notice and understand them:

AUDIBLE DISTRESS SIGNAL	DEFINITION
One long blast	Warning signal (coming out of slip or passing astern)
One short blast	Pass on port side
Two short blasts	Pass on starboard side
Three short blasts	Engine(s) in reverse
Five or more short blasts	Danger signal

## OVERTAKING / PASSING

The boat overtaking or passing must yield right-of-way to the boat being passed. The overtaking boat must make any adjustments necessary to keep out of the way of the boat being passed. The boat being passed has the right-of-way and must hold its course and speed.

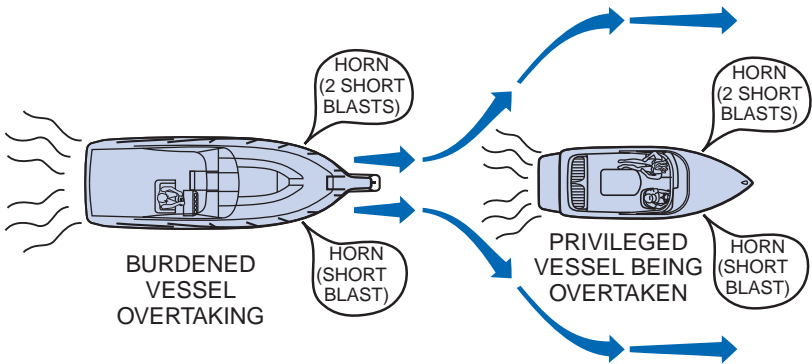

KC-0025-B



## MEETING HEAD-ON

When two boats meet head-on, neither boat has the right-of-way. Both boats should decrease speed, turn to the right and pass port to port. If, however, both boats are on the left side of a channel, each vessel should sound two short horn blasts and pass starboard to starboard.

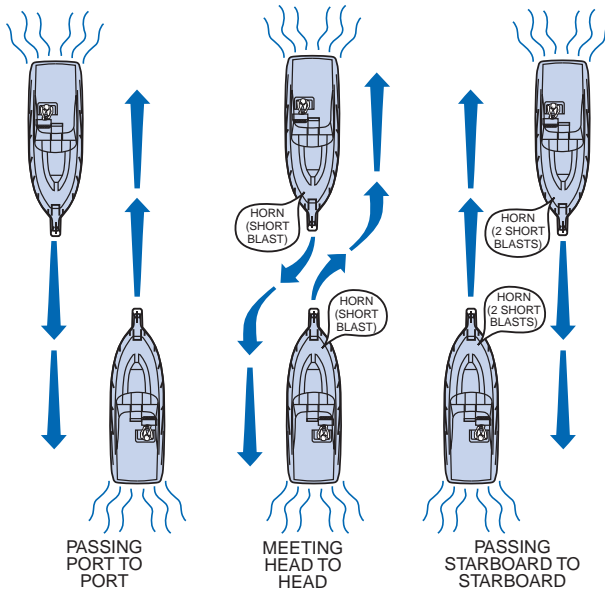

KC-0024-A



## CROSSING

In crossing situations, the boat to the right from the 12 o'clock to the 4 o'clock position has the right-of-way and must hold course and speed. The boat without right-of-way must yield and pass to the stern of the privileged boat. Boats going up and down a river have the right-of-way over boats crossing the river.

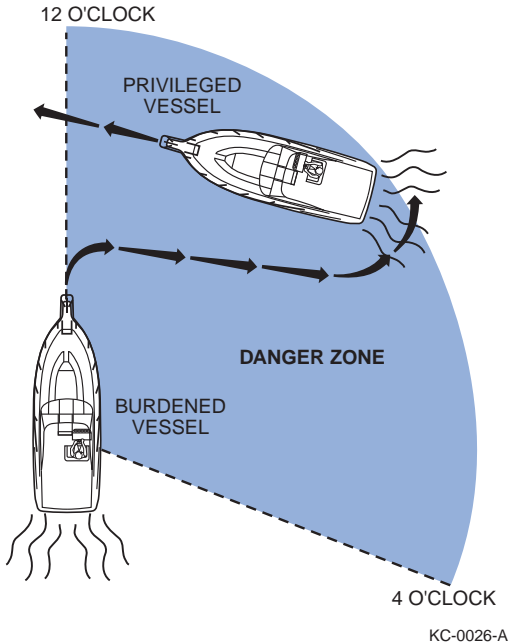



## NAVIGATION LOCKS

There are specific procedures in place for navigating through locks. Details may vary in certain regions, but in general:

- Stay between the red and green buoys that mark the river's navigable channel.
- Request an opening using a marine radio, cell phone or with a sound signal of one prolonged blast (four to six seconds) and one short blast (one second) within one mile of the lock. Sound signals can be made by using the lock's pull-cord or the boater's whistle, horn, megaphone or hailer.
- The boater should wait for the lock operator to signal with horn blasts. Additional signals may include traffic lights or flashing lights.
- Enter the lock at reduced speed.
- Make sure all passengers remain seated and wear their life jackets.
- Use fenders and boat hooks to avoid damage to the boat and the lock walls.
- When through, wait for the lock operator's signal (horn and/or lights), then leave the lock at idle speed. Military and commercial boats have priority over recreational boats.

## AIDS TO NAVIGATION

Learn to recognize the different buoys and day markers; they are the signposts of the waterways. The United States Aids to Navigation System (USATONS) is the primary marking system used on inland water, coastal waters and rivers. This system is maintained by the USCG.

There are two other navigation marking system variations boaters must follow in the United States:

- **Western Rivers Marking System** – When on the Mississippi River, tributaries above Baton Rouge, and several other rivers that flow toward the Gulf of Mexico.
- **Intracoastal Waterway (ICW)** – Runs just inland and parallel to the Atlantic Ocean and Gulf coasts from Manasquan, New Jersey, to the Mexican border. *Since ICW routes may travel next to non-ICW routes in opposing directions, navigate by the yellow symbols when following the ICW.*



Both systems are similar to USATONS but have subtle differences that must be understood. If you boat in these areas, visit [www.uscgboating.org](http://www.uscgboating.org) for navigation rules.

Navigational aids are designed and placed accordingly to help you navigate safely on the water. Learn to recognize the different buoys and day markers.

The following information is based on the USATONS. For further information, contact the USCG and state and local marine authorities. Also visit [www.uscg.boating.org](http://www.uscg.boating.org) for navigation rules.

The USATONS uses buoys, beacons and minor lights as markers.

**NEVER** tie or anchor to a navigational aid. This action is unlawful and dangerous to you, your boat and other boaters.

**NEVER** move or damage a navigational aid. This action is unlawful and dangerous for other boaters.

## BUOYS

Most anchored floating markers are generally referred to as buoys. Buoys have many uses and color schemes, and can vary in size and shape. The most commonly used buoy colors are white, red, green, yellow and black. Buoys may be unlighted or lighted. Some are audible; others have both an audible and a visual signal. Lights, bells and horns on buoys aid in night boating or poor visibility conditions. Buoys with unique light-flashing characteristics are identified on nautical charts with the specific flashing pattern.

Become familiar with the specific buoys used in the waters where you are boating. Contact local authorities for specific information and/or navigational aid charts for your waterways.

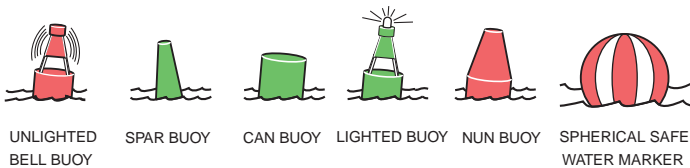

KC-0052C-B



## MOORING BUOYS

The only buoys you are permitted to moor to are mooring buoys. Mooring buoys are white with a blue horizontal stripe. Mooring to a navigation buoy, regulatory markers or lateral markers is illegal.



WHITE WITH BLUE BAND

MAY SHOW WHITE REFLECTOR OR LIGHT

KC-0020C-A

## DAYMARKS / DAYBOARDS

Daymarks or dayboards are fixed visual markers in the water. The markers are commonly attached to a post or piling and are sometimes accompanied by a light. Daymarks are either red or green and are usually



STARBOARD DAY MARKER

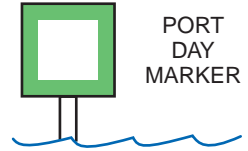

PORT DAY MARKER

KC-0021C-A

triangular- or square-shaped, though their shapes can vary. Daymarks often display numbers, which act as navigation guides. Red daymarks are usually triangular and sometimes show an odd number. Green daymarks are usually square and sometimes show an even number. The numbers on the markers are sequential and increase from seaward.

## LIGHTS AND LIGHTED STRUCTURES

Maneuvering a boat at night can be dangerous and confusing. To aid boaters with navigation and to warn of hazards, the USCG and state and local authorities maintain a variety of light structures. Some light structures are equipped with radio beacons, radar reflectors and/or fog signals.

### Minor Lights

Minor lights are colored according to the buoyage marking system in use. They are similar to lighted buoys, except they are usually higher and on more stable platforms to increase visibility. Most minor lights are part of a series to mark a channel, river, or harbor and fairways.



### Range Lights

Range lights are usually visible in one direction and help a boat operator navigate safely. Steering a course to keep range lights arranged in a line (one on top of the other) will help guide a boat through a channel.

RANGE LIGHTS

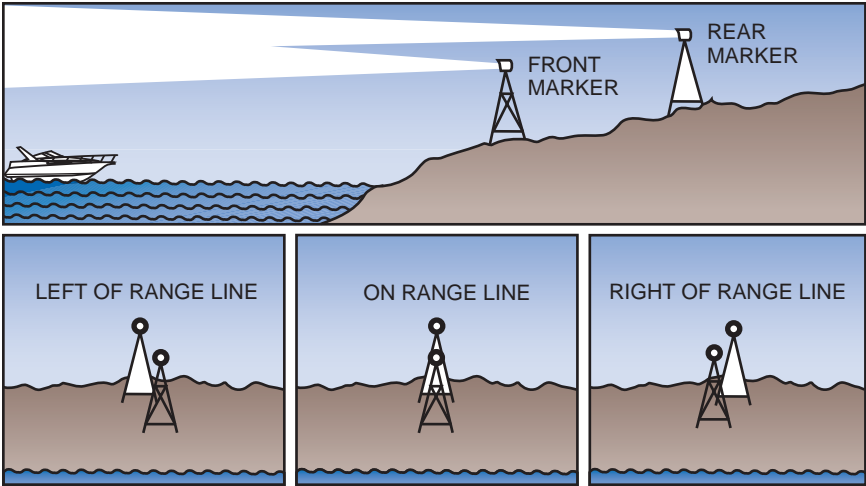

KC-0022C-A

### Lighthouses

Lighthouses can be found at harbor entrances, prominent headlands, isolated danger areas and along the coasts. These striped or patterned structures have unique flashing signals, which help boaters identify them.

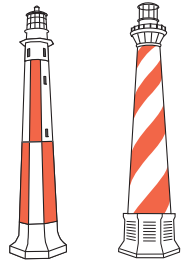

KC-0023C-B





## MARKERS

Seven (7) types of markers are used to assist the boat operator:

- Regulatory
- Range
- Special
- Lateral
- Safe Water
- Preferred Channel
- Isolated Danger

### Regulatory Markers

Regulatory markers are used to display information or indicate danger. Regulatory markers can be fixed visual markers or anchored floating buoys.

Fixed visual markers are usually white with orange geometric shapes that display information. Anchored floating buoys are white cylinder-shaped buoys with orange bands at the top and orange geometric shapes that may display information.

Following are the various orange geometric shapes used on these markers:

- Diamond – Indicates danger
- Diamond with cross marks inside – Indicates that a boater must keep away
- Circle – Indicates a controlled area or speed limit
- Square – Displays important information



DANGER



BOATS  
KEEP OUT



CONTROLLED  
AREA



INFORMATION

KC-0244C-A



## Range Markers

Range markers have many color schemes, may have numbers or letters and may be lighted or unlighted. They are placed in pairs within close distance of each other. They are commonly used in channels to guide boats safely through the center or safe line of navigation. Keep range markers visually in line with each other while navigating the waterway to avoid obstacles or other invisible dangers.

## Special Markers

Special markers are yellow and come in various styles and shapes. Lighted and unlighted daymarks and buoys vary in function. Many are used to display information and navigational direction rules. The most common special markers are those used in intercoastal waterways. Contact your state and local authorities for more information on special markers used in your boating area.

## Lateral Markers

Lateral markers are used to mark the sides of navigable channels. They can be buoys, daymarks or minor lights, and are red and green in color. They can be lighted or unlighted and may or may not have numbers.

The basic nautical rule of lateral markers is the phrase “Red, Right, Returning.”

The term “sea” generally refers to the ocean or a large body of water. “Seaward” refers to traveling from the sea or a large body of water inland or to a smaller body of water.

When traveling seaward – keep red markers to your port (left) and green markers to your starboard (right).

When returning from seaward – keep red markers to your starboard (right) and green markers to your port (left).

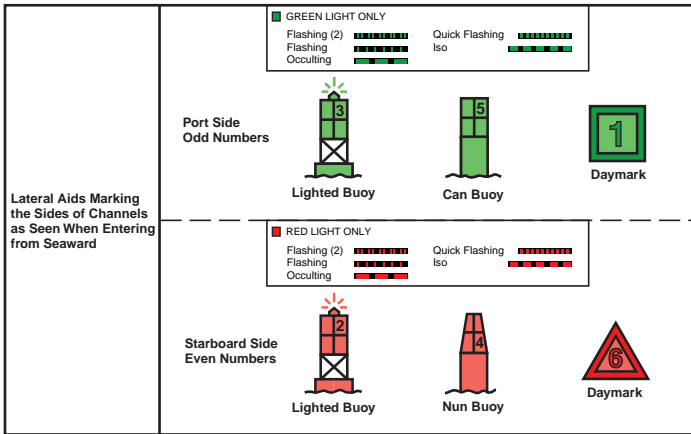

KC-0054C-A

## Safe Water Markers

Fairways and mid-channels may be marked with safe water markers or buoys. These markers indicate safe water all around. Safe water markers are red and white with vertical stripes, and are round or have a red spherical top mark.

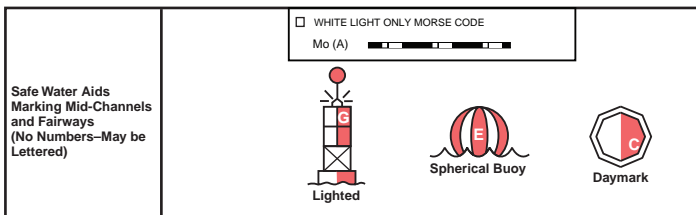

KC-0055C-A



### Preferred Channel Markers

Obstructions, channel junctions and preferred channels are marked with red and green horizontally striped can and nun-style buoys. The top band color indicates the preferred path to take. Use these markers in the same manner as lateral markers to follow preferred channels.

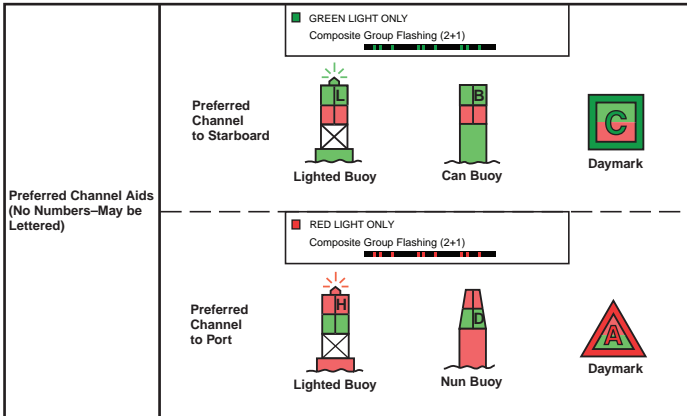

KC-0056C-A

### Isolated Danger Markers

Isolated danger markers indicate an isolated danger which may be passed on all sides. These markers are black with one or more broad horizontal red bands and are equipped with a top mark of two black spheres, one above the other. On inland waters, a buoy with alternating vertical black and white stripes may be used to indicate that an obstruction or other danger exists between the buoy and the nearest shore. Do not pass between the buoy and the shore.

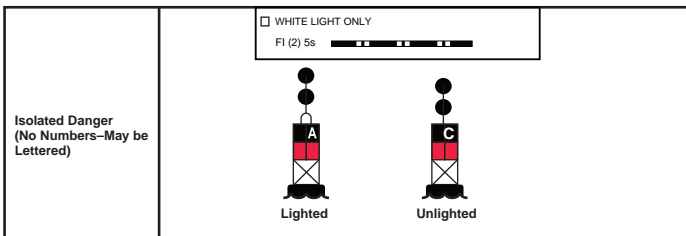

KC-0057C-A



## Other Special Signs and Markers

Various signs and markers are used throughout U.S. waterways for different purposes. In Florida, special signs are used to warn of “manatee” areas. These signs help to control speed and/or restrict areas from boating to conserve this endangered species. As a boat owner and operator, be aware of special information and markers on the waterways. Contact your state and local authorities for more information on local restricted or controlled areas and their markers.



SECTION

# 6

## NAVIGATION RULES AND AIDS

This Page Intentionally Left Blank

# Section 7

## OPERATING THE BOAT

Before operating the boat, review *Safety in Section 2*.



### **WARNING**

**Control Hazard: Certain actions can cause you to lose control of the boat:**

- *When accelerating the boat in the forward direction, the bow can rise and restrict visibility. Observe for obstacles and people before accelerating.*
- *The rotational thrust of the propeller under rapid acceleration can create high steering torque and rapidly change the direction of steering, causing loss of control.*
- *Do not trim the engine out too far or the boat may begin to “porpoise” (bounce up and down). Porpoising reduces control and visibility.*
- *Improper use of trim tabs or moving them down at high speeds can cause loss of control.*
- *If you lose control of the boat, pull back on the throttle and trim in at the same time.*

## BEFORE GETTING UNDERWAY

### SAFETY EQUIPMENT

Federal and local laws require certain safety equipment to be on board at all times. Responsible boaters carry additional equipment in case of emergency.

### FLOAT PLAN

Complete a float plan before departure and leave it with a reliable person who is aware of your intentions while on the water. In case of emergency or if you do not return as planned, this information can be helpful to the USCG or others in rescuing or contacting you. There are several float plan apps that make it easy to fill out and email the plan. For more information on float plans or to download a float plan form, go to:

<http://www.floatplan.uscgaux.info>



## CONSIDERATIONS FOR LONGER VOYAGES

Boaters intending on making longer cruises in unfamiliar waters should keep the following in mind:

- Use extreme caution in tidal waters. Consult tidal charts or NOAA tide predictions ([https://tidesandcurrents.noaa.gov/tide\\_predictions.html](https://tidesandcurrents.noaa.gov/tide_predictions.html)) and travel on the “rising tide” if possible.
- Measure the boat’s actual fully loaded draft with full fuel, water, passengers and gear. Do not rely on the boat manufacturer’s published draft specifications.
- Measure the boat’s actual height with a typical load, including any options mounted up top such as rod holders, lights, radar dome, etc. Do not rely on the boat manufacturer’s published height specifications.
- In big water, it is imperative to have all the recommended safety equipment for boating on Great Lakes and open ocean.
- Be sure the electronic chart software is up-to-date and keep paper backup charts.
- Make slip reservations in advance and immediately contact the marina master on VHF channel 16 when in range (typically three to five miles).
- Avoid cruising in shipping lanes whenever possible.

## SYNCHRONIZING GPS DATUM WITH CHART DATUM

The datum set up in the GPS receiver must match the datum used to create the map the boater is using. The three common datums in use in the continental United States are:

- NAD 27 CONUS – North American Datum of 1927 for the Continental United States (Common on older United States Geological Survey [USGS] maps)
- NAD 83 – North American Datum of 1983 (Used on most newer USGS maps)
- WGS 84 – World Geodetic System of 1984 (The default datum used by the GPS system)

The chart datum is usually printed somewhere in the title block. Never apply a GPS position to a chart without first ensuring that the GPS datum in use agrees with the datum used to construct the chart. Using incorrect datum can introduce hundreds of meters of position error. By entering the datum in use, the GPS will automatically correct the information it provides to match the chart. Refer to the *GPS Operator’s Manual* for details.





## PRE-DEPARTURE SAFETY CHECKLIST

The following checks are essential to safe boating and must be performed before starting the engine or getting underway. Perform these checks every time you operate the boat so they become routine.

Never launch the boat or leave the safety of the dock if any problem is found during the pre-departure safety check. A problem could lead to an accident during the outing, causing severe injury or death. Have any problems corrected before proceeding:

- Check the current and forecasted weather reports, as well as wind and water conditions.
- Make sure the operator is qualified to operate the boat and does not use drugs or alcohol while at the helm.
- Make sure all required safety equipment is on board.
- Make all passengers aware of safety procedures.
- File a float plan.
- Have all required documents on board.
- Have all maps or navigational charts for the intended destination on board.
- Be sure all passengers are properly seated.
- Be sure the boat is not overloaded.
- Check the engine emergency stop switch lanyard for proper installation and operation.
- Be sure the fire extinguisher is fully charged.
- Check bilge drain plugs for proper installation.
- Be sure all water has been pumped from the bilge area.
- Have plenty of emergency food and water on board.
- Check the bilge blower (if equipped) for proper operation, and be sure no fumes are present in the bilge area.
- Be sure all required equipment is on board (mooring lines, anchor lines, tool kit, etc.).
- Be sure you have enough fuel for the return trip.
- Check all compartments for fuel fumes.
- Check that no fuel, oil or water is leaking or has leaked into the bilge compartment.
- Check all hoses and connections for leakage and damage.
- Check the hull and propeller for damage.
- Check the engine cooling water intake pickup for blockage.
- Check that batteries are fully charged and the battery terminals are clean and tight.
- Check the electrical systems and navigation lights for proper operation.



- Be sure no person or obstacle is near the propeller.
- Check that the throttle/shift control is in the NEUTRAL position.
- Check the steering system for proper operation.
- Check that all required maintenance has been performed.

## BOARDING

Helpful guidelines when boarding a boat:

- Always step, rather than jump, into a boat.
- Avoid stepping on fiberglass or other potentially slippery surfaces.
- Always board one person at a time.
- Never board while carrying gear. Set the gear on the dock, board the boat and then pick up the gear.
- It is courteous to always ask for permission to board so the owner/operator is aware of your presence on the boat.

See the *Using the Boarding Platform/Ladder* section of this manual for re-boarding the boat from the water.

## BOAT LOADING

The safety and performance of the boat depends on load, weight and the distribution of each.

The person/load capacity is determined by the USCG. A capacity plate is usually located within clear visibility of the boat operator or helm area. The capacity plate indicates limits for loading the boat, which are enforceable by law.

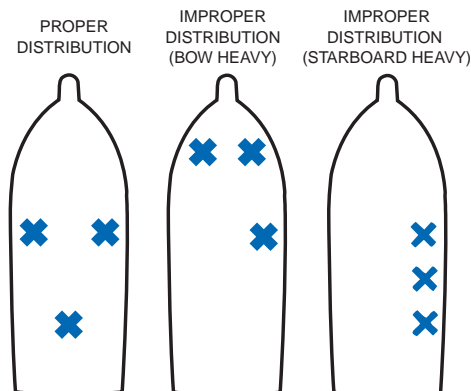

KC-0335-A

**WARNING**

***Sinking Hazard: NEVER exceed the USCG certified maximum capacities under any circumstances. Exceeding the limitations stated on the capacity plate can cause the boat to sink or the passengers and/or operator to drown, resulting in death or serious injury.***

- Board passengers one at a time and distribute them equally to maintain equal buoyancy of the boat.
- Distribute weight equally from port to starboard and fore to aft. The shifting of weight may be required when underway to maintain an efficient trim position for optimum performance.
- Stow and secure all loose gear in stowage areas to prevent load shifting.
- Do not stow gear on top of safety equipment; safety equipment must be quickly accessible.
- In adverse weather, reduce the load in the boat. Person and load capacity ratings are calculated for normal boating conditions.

**WARNING**

***Man Overboard Hazard: Always use the boat manufacturer's seating designation while the boat is underway. Never allow anyone to sit in rear aft-facing seats while the boat is underway. This could result in a man overboard hazard.***

## FUELING

### FUEL MANAGEMENT

Use the “one-third” rule for fuel management. Use one-third of the fuel to reach your destination, one-third to return and one-third as reserve fuel.

### FUEL SUPPLIERS

Refuel only at approved suppliers such as marina fuel docks or automotive fuel service stations. Approved suppliers have safeguards in place to lessen the likelihood of static discharge. Use only containers and funnels approved for use with gasoline fuels. See the Before Refueling section of this manual for additional information.



SECTION  
**7**

# OPERATING THE BOAT

## STATIC ELECTRICITY AND THE FUEL SYSTEM

The boat's built-in fuel tank has a bonding system that protects it from creating and discharging static electricity. The boat must be in contact with the water or on its trailer when refueling to complete the bonding system.

If the bonding system is not complete, an electrostatic spark may occur.

**⚠ WARNING** *Fire/Explosion Hazard: An electrostatic spark can ignite fuel vapors, causing a fire and/or explosion.*

Use extreme caution when filling the fuel system. In addition:

- Remove portable fuel tanks from the boat and place them on the ground to fill. The fuel tank must be properly grounded before refueling.
- Do not refuel a built-in fuel tank if the boat is suspended from a sling or another type of boat lift system. Suspending the boat from the water interrupts its bonding system. Using a portable fuel tank to refuel the boat while it is suspended may cause an electrostatic spark.

## FUEL (GASOLINE)

Fuel for marine gasoline-only engines must be carefully selected to avoid fines and possible catastrophic engine damage not covered under warranty. It is illegal for any person to tamper with emissions control devices such as the fuel system, and it is also illegal for any person to mis-fuel a marine gasoline-only engine with a blend of more than 10% ethanol.



KCB-0004

While it is always preferable to use fuel that does not contain ethanol (usually labeled as “marine” or “recreational”), most marine engines are designed to tolerate E10 (10% maximum ethanol) fuel as long as the fuel meets the engine manufacturer’s octane requirements. When using fuel containing ethanol, buy fuel in smaller quantities that will be consumed during a weekend of boating. Fuel degrades quickly and the engine operates better on fresh fuel. Use marine fuel stabilizer to treat and reduce degradation of any remaining fuel.



KCB-0005



Fuels that contain bio-isobutanol at any percentage are safe to use in marine products and have none of the limitations of ethanol biofuel additives.

Do not use octane boosters or other fuel additives. Purchase fuel from a quality supplier selling high volumes to ensure the fuel is fresh. For more information go to: [www.toptiergas.com/licensedbrands/](http://www.toptiergas.com/licensedbrands/)

## NOTICE

*Fuels that are blended to contain more than 10% ethanol may damage the engine, oil system or fuel system and should not be used in marine engines. Fuels that contain more than 10% ethanol can corrode metal parts, deteriorate rubber and plastic, or weaken gaskets. Damages caused by the use of fuels that contain more than 10% ethanol or fuels that do not meet engine manufacturer octane requirements are not covered by your warranty.*

## BEFORE REFUELING



### WARNING

***Fire/Explosion Hazard: Gasoline is extremely flammable and highly explosive under certain conditions. Be sure to check the fuel hoses and connectors for leaking and deterioration before fueling and on a monthly basis.***

- Refuel the tanks only in a well-lighted area.
- Know where the fire extinguishers are.
- Stop all engines, motors and appliances before refueling. Keep the engine compartment blower on if equipped.
- Do not smoke or allow open flames or sparks nearby, within 50 feet (15 meters), of the fueling area.
- If equipped, close all doors, windows, hatches and ports.
- Determine the amount of fuel required to fill the tanks. Do not overfill the fuel tanks. Allow for at least a 2% expansion of fuel when refueling. If the fuel temperature is 32°F (0°C) or lower, allow at least 6% for fuel expansion.



## FUELING

The fuel filler on boats with built-in tanks is usually located in the aft area. The fuel tank is equipped with either a shutoff valve or antisiphon valve. The shutoff valve requires you to manually turn the fuel valve, while the antisiphon valve operates automatically. Because gasoline fumes are heavier than air, they will sink to the lowest part of your boat, such as the bilge. Always evacuate fumes with the bilge blower (if equipped) before attempting to start the engine.

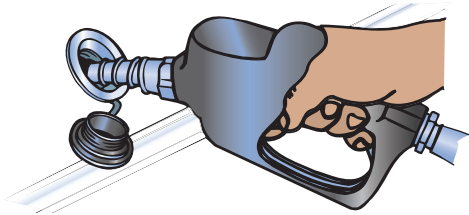

KC-0027C-A

### **NOTICE**

*To prevent unwarranted engine damage, refer to the Engine Operator's Manual for recommended fuel and oil specifications.*

## REFUELING BUILT-IN FUEL TANKS

Maintain contact between the fuel nozzle and the fill pipe at all times, before and during refueling, to prevent an electrostatic spark. If it's necessary to use a funnel, use a metal funnel. Do not fill built-in tanks from unapproved portable containers.

## AFTER REFUELING

- Close the fuel fill cap thoroughly.
- Wipe up any spilled fuel completely. Dispose of rags properly onshore.
- Open all doors, windows, hatches and ports to ventilate all spaces. Check for fuel vapors before starting any engines or appliances.
- If equipped, operate the blower for a minimum of four minutes before starting the engine.



## GETTING UNDERWAY

The following basic boat maneuvering and operation principles do not cover all conditions or situations you may encounter during operation. It is important for you and anyone else operating the boat to have certified instruction before operating the boat.

Always advise all passengers on board of your steering, stopping and accelerating intentions. Brief passengers on:

- Safety equipment location and operation
- Basic boat operation
- Radio operation
- Reboarding procedure
- Man overboard procedure
- Emergency procedure
- Hazardous weather procedure
- Docking procedure
- Fueling procedure

Be sure all passengers are properly seated in designated seating positions and not riding on the bow, bow pulpit, deck, gunwale or rear sun deck while underway. Passengers must use caution when riding in the bow. Move to the aft passenger seats during rough water operation or if visibility is restricted.

## STARTING

The following information is intended as a basic guideline only and may not apply to your specific engine or controls. See the *Engine Operator's Manual* or control manufacturer's information for instructions on starting and operating the engine, adjustments and maintenance.

- Secure the boat to the dock before starting the engine.
- Check that the throttle is in the NEUTRAL position.
- Turn the battery selector switch to the appropriate ON position.
- Operate the bilge blower (if equipped) for four minutes or long enough to fully evacuate the engine and bilge compartments of explosive fumes.



**⚠ WARNING** *Fire/Explosion Hazard: If equipped with a bilge blower switch, always operate the bilge blower for a minimum of 4 minutes prior to starting the engine. Gasoline vapors can explode, resulting in injury or death.*

- Check the bilge for fuel vapors.
- Operate bilge blower for 4 minutes.
- Verify that the blower is operating properly.
- Always run the blower when the boat is operating below cruising speed.
- Attach the engine emergency stop switch lanyard to the boat operator.
- Check that all passengers are seated properly.
- Position the lower drive power trim to the full DOWN position.
- Start the engine.

## STEERING

Steering a boat is very different from steering an automobile. Steering and maneuvering a boat is far more difficult and requires time and practice to master.

When steering a boat, it is important to understand the causes and effects of turning. Since both thrust and steering are at the stern of the boat, the stern will push away from the direction the steering wheel (helm) or tiller arm is turned. The boat seems to skid across the water while turning, which feels very different from an automobile making a turn.

Steering in reverse has its own challenges. Practice forward and reverse steering to gain comfort and to feel in control of the boat in any steering situation.

Be prepared for wind and current while steering the boat. Steering in wind or water currents is difficult and requires skill to be able to anticipate and compensate for these effects.



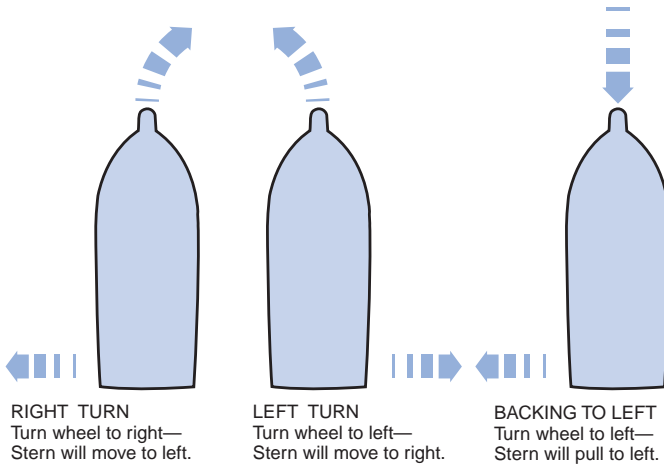

KC-029-A

Rotational thrust of the propeller is an aspect most single propeller-driven boats share and needs to be compensated for at slow speeds. During rotational thrust, torque is transmitted to the helm and may cause the boat to drift either port or starboard when moving forward at a slow speed. Rotational thrust usually goes unnoticed at high speeds. While moving forward at a slow speed, constant helm corrections are usually necessary to maintain a straight course.

Twin-engine and dual-prop boats usually compensate for rotational thrust of the propellers by using one counterrotating drive with a counterrotating propeller, and one standard clockwise-rotating drive and propeller to reduce the effects of steering torque at all boat speeds.

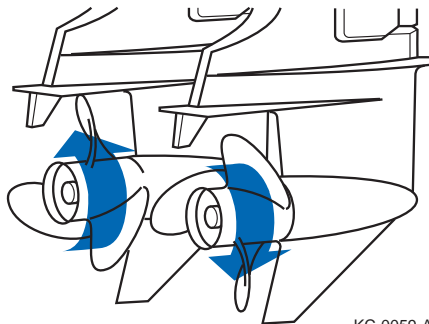

KC-0059-A



### Twin-Engine Steering

When maneuvering with twin engines at low speeds, steer using the independent thrust of the port and starboard drives in conjunction with helm movements. Steering in this manner can be very effective, especially when maneuvering in restricted areas and when docking.

Practice using the throttles to control steering of the boat. Practice these maneuvers in open water away from others before attempting them near docks or other boats.

- Before attempting to make close turns at low speed, always position the throttles in IDLE.
- Reverse the direction of the engine on the side you want to turn. If you want to turn starboard, for example, shift the starboard engine into REVERSE. The forward speed of the port engine, along with the reverse rotation of the starboard engine, will pivot the boat into a starboard turn.
- Use quick “bursts” of throttle to control the boat. Keep in mind that once the boat starts to move, momentum will carry it through.

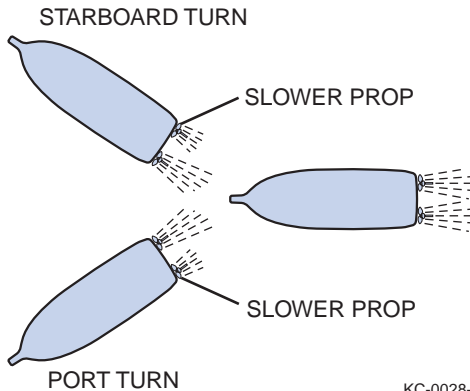



## STOPPING

A boat does not have brakes. Controlling the boat to a stop and while stopped are important skills that must be learned. Reverse thrust is commonly used to slow and stop a boat. The continued momentum of a boat will vary according to the boat design, load and speed. You must also consider and learn to compensate for the effects of wind and current. Stopping in wind or water currents is difficult and requires skill to be able to anticipate and compensate for these effects.

- To stop or slow forward motion, always gradually return the throttle(s) to the slow IDLE position, pause and shift into NEUTRAL, then pause and shift into REVERSE.



### WARNING

**Control Hazard: Gradually return the throttle(s) to the slow IDLE position. Failure to do so can cause loss of boat control and engine propulsion system damage.**

- If the boat has been driven for a long period of time at high speed, allow the engine a two- to three-minute cool-down period at low idle in NEUTRAL.
- Turn the ignition key to the OFF position.

### NOTICE

*Never pull the lanyard from the engine emergency stop switch for normal shutdown. Doing so may impair your ability to restart the engine quickly.*

- Avoid collisions; at high speeds the boat will require more time and distance to stop or slow.
- The proper use of trim tabs and outdrive trim angle is important when slowing to a stop. Qualified local boating authorities can provide proper instruction in slowing and stopping your boat.



## SHIFTING

The following information is a basic guideline only and may not apply to the specific shift control. See the *Engine Operator's Manual* or control manufacturer's information for the shift control operation, adjustment and maintenance.

- Most side-mounted throttle and shift controls have a neutral detent lock that must be released before shifting from NEUTRAL.
- Always use a brisk and decisive movement when shifting into or out of gear.
- Always pause in NEUTRAL before shifting from FORWARD to REVERSE, or REVERSE to FORWARD. Most throttle and shift controls have a detent position for NEUTRAL, FORWARD and REVERSE engagement positions. These detent positions are important; when shifting into and out of gear, always pause in these positions.
- Never shift into REVERSE while your boat is in FORWARD gear when traveling at any speed above idle.
- Always keep the shift control clean and clear of obstructions.

## ACCELERATING AND RUNNING UNDERWAY

You must understand the boat's equipment and controls in order to drive and control the boat in a forward direction at all speeds and in all conditions. Learning to drive and control the boat can be challenging; take this matter seriously and spend plenty of time practicing.

The phrase "on plane" is commonly used when referring to the running angle of a boat in forward motion. When a boat is "on plane," its hull is usually running level or almost level with the water's surface, which is considered level. The level "plane" of the water's surface is the most efficient angle to run in. This basically means that the boat is running on top of the water and not plowing through it.

Factors to consider when accelerating a boat forward and running at the most efficient planing angle are:

- Boat design
- Hull type and condition
- Boat load and distribution of weight
- Engine capability and condition
- Propeller type, size and condition
- Outdrive and boat power trim equipment and condition

Because all boats are different and vary in design, purpose and load, planing angles and characteristics will vary among all boats. Become familiar with the boat's characteristics and obtain qualified assistance.



The following guidelines provide a basic understanding of forward acceleration and operating on plane while underway:

- Always look in front of and around you before proceeding. Avoid collisions before accelerating; be aware and stay clear of people and obstacles in the water.
- Always advise all passengers on board of your intention to accelerate and get underway.
- Stow and fasten all loose gear.
- Make sure the engine emergency stop switch lanyard is connected to the operator.
- If equipped, adjust the boat trim tabs up or to a neutral position with the hull.
- If equipped, adjust the engine power trim to the full-in position.
- Shift from NEUTRAL into FORWARD detent idle position.
- Adjust steering to the direction of travel.
- Using a controlled and constant motion, move the throttle control forward.

**WARNING**

***Control Hazard: When accelerating forward, the bow can rise and restrict visibility. Never remove your hand from the steering wheel. The rotational thrust of the propeller under rapid acceleration can create high steering torque and rapidly change the direction of steering, causing loss of control.***

- As the boat begins to move, the bow will rise and the boat will tend to plow through the water. As acceleration increases, the boat will begin to plane or level out within a few seconds. If it will not plane to a near-level position and has sufficient horsepower, slowly reduce the throttle back to the FORWARD detent idle position. Recheck the load distribution and trim equipment position to determine the cause.
- Once the boat is on plane, the steering torque will diminish; however, never remove your hands from the helm while underway. While running at a planed position, you will notice greater throttle response and steering control as you continue to accelerate or achieve the most comfortable and safe speed for the conditions. You can achieve better performance, control and running efficiency using the engine's power trim and the boat's trim tabs, if equipped.
- Be aware of the wake you create and anticipate the effect it will have on others. During acceleration, deceleration and at speeds other than on plane, a heavy wake is usually created. You are responsible for the boat's wake and any damage or injury it causes.
- Obey no-wake areas and speed-controlled areas.



- Stay clear of or at a safe distance from other boats.
- Avoid collisions; at high speeds the boat will require more time and distance to stop or slow.

## CHECKS DURING AND AFTER OPERATION

- Check gauges frequently for signs of abnormal conditions.
- Check that controls operate smoothly.
- Check for excessive vibration.

## TRIM TABS

Trim tabs adjust the boat's trim angle and are primarily used to compensate for uneven weight distribution, listing, water conditions and other factors that can hinder efficient planing. Trim tabs are either power or manually adjusted, and vary in application, style and shape.

Trim tabs are added to a boat's hull at the stern to lift the stern and effectively make the hull longer. Trim tabs raise and lower to deflect and redirect water. This change in water flow creates upward pressure under the tabs, raising the stern and at the same time lowering the bow. The tabs are commonly used at the same time. They can, however, be used independently to adjust for water conditions, wind and boat weight distribution.

Trim tabs can sometimes help to keep a boat on plane at lower speeds and help a boat achieve plane quicker. The boat operator can adjust trim tabs by using a switch at the helm area. Trim tab gauges are available in most applications to provide a visual gauge-to-trim position. Most gauges indicate trim position in a range from UP (out) to DOWN (in).

Trim tabs are primarily used in conjunction with the engine's power trim.

General trim tab operation guidelines:

- When getting on plane, adjust the trim tabs to the best position to allow the boat to plane. A few trial runs will help you determine what position works best for your application. In most applications, this will be full up or parallel with the hull at a neutral angle. The further down the trim tab position, the more the stern lift increases and the bow lift decreases.
- Once on or near plane, use the engine's power trim to achieve better control and an efficient planing position.
- Further adjust (usually UP) the trim tabs to fine-tune planing efficiency and increase speed.



## WARNING

**Control Hazard:** Always use caution when operating the trim tabs. Improper use of trim tabs or moving them **DOWN** at high speeds can cause an accident or injury. See Safety Precautions at the beginning of this section for more details.

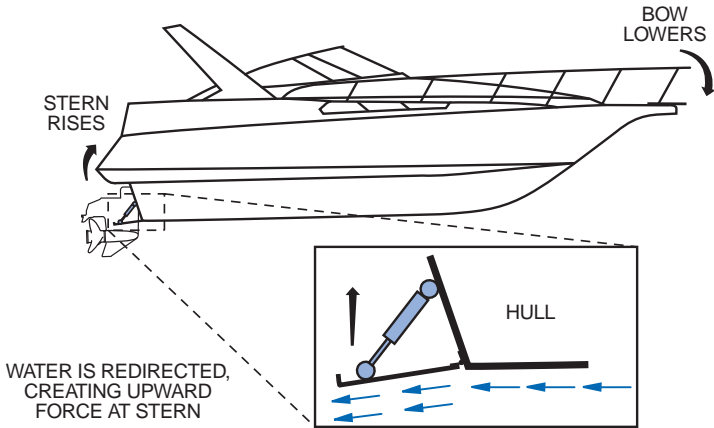

KC-0032-A

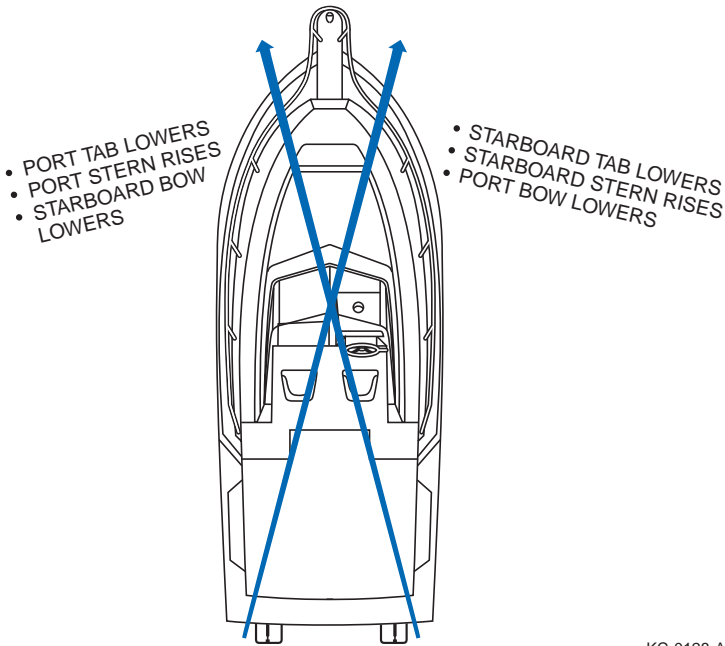

KC-0128-A

## POWER TRIM AND TILT

The following information is a basic guideline only and may not apply to your specific power tilt unit. See the *Engine Operator's Manual* for information on your power tilt operation, adjustment and maintenance.

The engine's power tilt generally operates in conjunction with the power trim system, which is commonly called power trim and tilt. This system allows you to raise and lower the lower drive unit and propeller to adjust trim (the planing and running angle of the boat while underway) and tilt (used to position the lower drive unit up beyond the power trim range used for trailering, launching or beaching). Never use power tilt while the engine is running.





## POWER TRIM OPERATION

The following information is a basic guideline only and may not apply to your specific power trim unit. See the *Engine Operator's Manual* for information on your power trim operation, adjustment and maintenance.

The engine's power trim allows you to raise and lower the lower drive unit and propeller to adjust the planing and running angle of the boat while underway.

Boat trim adjustment while underway greatly affects boat performance and efficiency. During normal operation while underway at speed, trim the boat to the best possible position to reduce the wetted surface of the hull. With less boat in the water, both speed and fuel economy increase. Adjust systems with manual trim adjustment for best overall operation for the load and conditions. Engines with power trim allow for continuous adjustment for best results.

Adjust the power trim by using a switch at the helm area or on the throttle control. Trim gauges are available in most applications to provide a visual gauge-to-trim position. Most gauges indicate trim position between UP (out, away from the transom) and DOWN (in, closer to the transom).

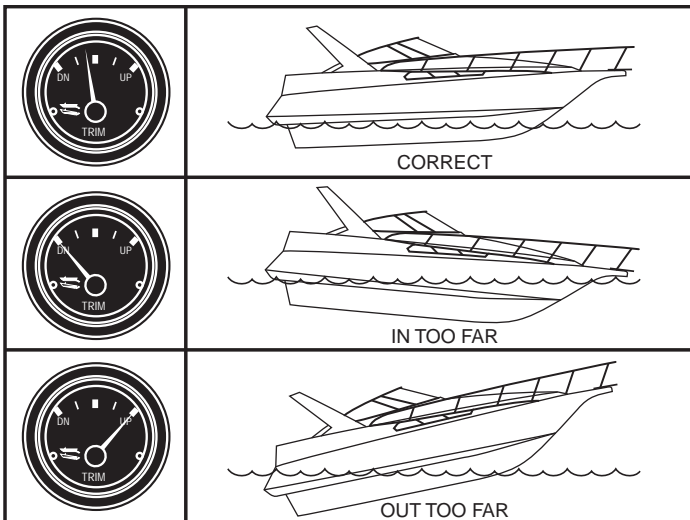

KC-0034

**General effects of power trim underway:**

Trim in too far (closer to the transom):

- Speed decreases.
- Fuel economy decreases.
- Boat may handle and steer poorly.
- Boat will have difficulty achieving a proper running, planing position.

Trim out too far (away from the transom):

- Steering torque increases.
- Speed decreases.
- Fuel economy decreases.
- Boat may handle and steer poorly.
- Boat will bounce or porpoise.
- Engine RPM increases.
- Propeller may ventilate as it nears the surface of the water and slip excessively as it pulls air from the surface. This will cause engine RPM to rapidly rise.
- Boat will have difficulty getting on plane from an idle position.

**⚠ WARNING** *Control Hazard: Do not trim the engine out too far or you may lose control of the boat. If you lose control of the boat, pull back on the throttle and trim in at the same time.*

See the Operating the Boat section of this manual for more details.

**General power trim operation guidelines:**

- When getting on plane from an idle position, start with the trim full in. As the throttle position increases, the boat speed will increase and drive the bow up. As acceleration proceeds, the bow will start to come down. When the bow starts to fall and the boat begins to plane, slowly start to trim out.
- Trimming out while underway generally causes the boat to rise up and plane. The boat begins accelerating without adjusting the throttle as less of the boat is dragging in the water. Trimming up causes the engine RPM to increase. It is very important to watch the engine tachometer to keep it at or near full throttle operating range and not to exceed the engine's wide-open throttle operation range. See the *Engine Operator's Manual* for the engine's wide-open throttle operation range.
- To find the optimum trim position while underway, run the boat at a stable planed angle with the least possible amount of the hull in the water. The boat reaches optimum trim position when it is not porpoising or plowing excess water.



High-speed operation on smooth water provides stability, but you must maintain control by using quick reactions and adjustments. Know your limits and stay within them. Keep one hand on the steering wheel and the other on the throttle controls at all times.

**WARNING**

***Control Hazard: If you lose control of the boat, pull back on the throttle and trim in at the same time.***

Constant adjustments are necessary for rapidly changing conditions. Small inputs of throttle and steering are exaggerated at high speeds. Depending on the speed, keep watch well ahead so that you have enough time to react.

If the boat has trim tabs, you can achieve further boat trim adjustment by using the trim tabs in conjunction with the engine power trim equipment.

## DOCKING

Practice leaving and approaching the dock to become familiar with the procedures.

### Helpful guidelines when departing from the dock:

- Make sure you have sufficient space to maneuver the boat away from the dock, other boats and any other obstacles that may hinder your departure.
- Always allow sufficient clearance to the stern for the engine to clear any obstructions.
- Be aware of other boat traffic, wind and water conditions before departing.
- Make sure the engine is started and you have boat movement under control before casting off any mooring lines.
- Always proceed slowly when departing from a dock.

### Helpful guidelines when docking:

- Make sure you have sufficient space to maneuver your boat around the dock, other boats and any other obstacles that may hinder your approach.
- Be aware of other boat traffic, wind and water conditions on your approach.
- Approach from a direction against the wind or current.
- When possible, approach slowly from a 45-degree angle and then steer parallel to the dock.
- Have fenders, dock lines and assistance ready.



**⚠ WARNING** *Personal Injury Hazard: Never use your hand, arm or any other part of your body to attempt to keep the boat from hitting the dock. The boat could push against the dock, causing severe injury.*

- If possible, throw a mooring line to a person on the dock and have that person secure the bow. With the bow secure, swing the stern in with the engine or pull it in using a boat hook or the stern line.
- Tie off the bow and then the stern.
- Use bow and stern dock lines, as well as spring lines, for additional security.
- Use fenders to protect the boat from damage.
- Never attach a dock line to a point or part of the boat that is not designed to withstand the stress and the weight of the boat.
- If planning on docking the boat for a long period of time, use chafing protectors on the lines to protect the boat's finish.
- Leave some slack in the lines to allow for wave movement or tidal action if applicable.

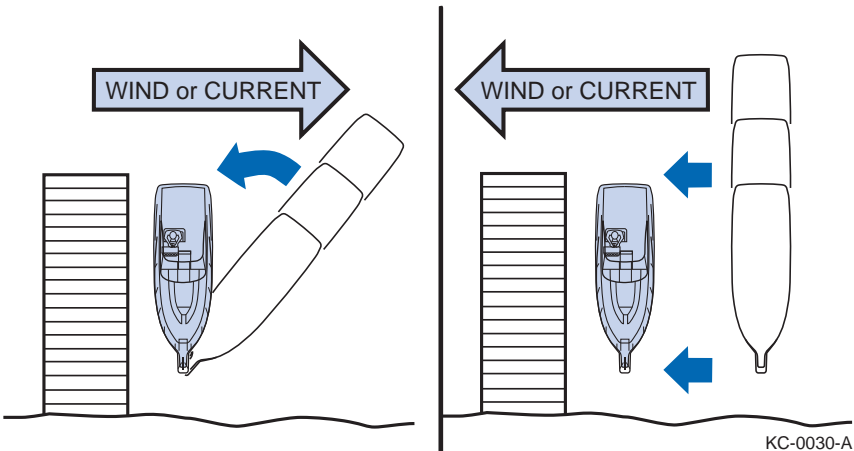



## MOORING

Because mooring configurations vary, consult with other experienced boaters or the boat dealer for recommendations on properly mooring the boat. Always moor the boat securely to prevent personal injury or property damage.

### Helpful guidelines when mooring:

- Each mooring line must be of the appropriate strength, material and type to safely secure your boat when moored.
- Each mooring line must be longer than the length of the boat.
- Use bow and stern mooring lines, as well as spring lines, for additional security.
- Use fenders to protect the boat from damage.
- When possible, tie up with the bow facing into the wind or current.
- Never attach a mooring line to a point or part of your boat that is not designed to withstand the stress and the weight of the boat.
- Only use the bow eye, stern eyes and other cleats or attachment points that have been approved for mooring.
- If you plan on mooring the boat for a long period of time, use chafing protectors on lines to protect the boat's finish.
- Leave some slack in the lines to allow for wave movement or tidal action if applicable.

## ANCHORS AND ANCHORING

Anchors are available for various applications and come in many sizes, types and shapes. Boat weight and size are primary factors in choosing an anchor. When selecting an anchor, consult other qualified boaters familiar with the waters or the boat dealer.

Anchor line is constructed from various materials and is available in many diameters and types. The anchor rode for recreational boats consists of the anchor line connected to a length of chain attached to the anchor. Consult with the boat dealer for a recommendation on appropriate lines for the boat anchor and application.

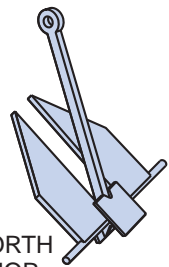

DANFORTH  
ANCHOR

KC-0042-A



For most applications, anchor line length should be at least six to seven times longer than the depth of the water in which you are anchoring. Always have plenty of additional anchor line on board. If anchoring in tidal waters, consider a rode chain about the length of the boat and increase the total anchor line length to ten times the depth of the water at low tide.

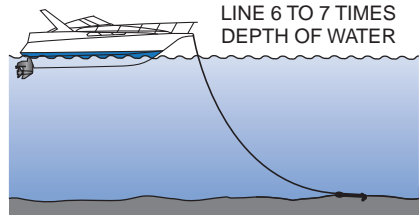

KC-0041-A

**⚠ WARNING** *Sinking Hazard: ALWAYS anchor from the bow; NEVER anchor from the stern. A small amount of current will make a boat unsteady. A strong current can pull a boat anchored by the stern under the water and keep it there.*

**⚠ WARNING** *Collision Hazard: ALWAYS anchor in areas where the boat will not disrupt other boats. Do not anchor in a channel or tie up to any navigation aid. It is dangerous and illegal.*

#### Helpful guidelines when anchoring:

- Make sure the anchor line is tied to the anchor. Tie the other end of the line to the forward cleat or bow eye.
- Head the boat into the wind or current over the spot where you want to lower the anchor.
- Stop the boat before lowering the anchor.
- Slowly lower the anchor until it hits bottom.
- Allow the boat to back away, keeping tension on the line.
- Release at least six to seven times as much line as the depth of the water.
- Secure the anchor line to the bow cleat or eye.
- Firmly pull on the line to make sure the anchor is holding.
- Occasionally check your position against the shoreline. If the anchor is dragging and the boat is drifting, reset the anchor.

#### Helpful guidelines when weighing (pulling in) the anchor:

- Start the engine(s).
- If necessary, move forward until enough tension is off the anchor line to allow for retrieval of the anchor. Avoid running over the anchor line; retrieve the line as you approach the anchor.
- Once the anchor line is straight up and down, lift the anchor from the bottom.



- If the anchor is stuck, attach the anchor line to the bow cleat so it is tight. The up-and-down motion of the bow from wave action may loosen the anchor from the bottom. If the anchor remains stuck, let out a few more feet of line and attach it to the bow cleat. While keeping tension on the line, slowly maneuver your boat around the anchor to help loosen it. Avoid running over the anchor line.
- Always stow and secure the anchor and line before departing.

## WINDLASS

The boat may be equipped with a windlass for deploying and retrieving the bow anchor using a notched wheel to engage chain links/rope. Windlasses on recreational boats are usually driven by an electric motor and controlled by rocker, foot or remote control switches and may be a vertical or horizontal style. Windlasses have a “chain locker” for storing the chain/rope, a chain stopper with a snubber and/or a tie-off cleat to secure the anchor in deployed or retrieved positions. The boat may be equipped with one or more up/down control switches and possibly a chain/rode counter.

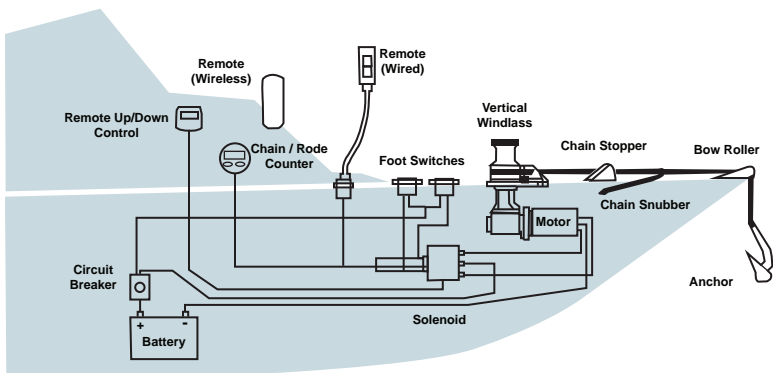

KC-6018



### WARNING

**Severe Injury Hazard: Always keep limbs, fingers, hair and clothing away from the anchor, rode and windlass during operation. Check that there are no swimmers in the water or divers nearby when dropping anchor. Be sure the anchor is fully secured after retrieval.**



When the anchor is retrieved, always use the chain-stopper and attach the snubber to prevent accidental release. When the anchor is deployed, always secure the anchor rode to the anchor cleat. Rode can be rope or chain but is often a combination of both.

If there is no chain counter alarm, consider marking the chain with paint to reduce the potential for boat damage during retrieval. Use yellow at 6 feet and red at 3 feet as a visual indication to slow down. Windlasses can be dangerous or can damage the boat if used improperly, so read the windlass manufacturer's owner's information thoroughly and practice deploying and retrieving the anchor in controlled conditions before actual use.

## CHAIN COUNTER

The boat may be equipped with a chain/rode counter mounted at the helm to display the length of rode deployed. Most counters can be adjusted for different units of measure and are equipped with a retrieval alarm. This alarm helps prevent boat damage by communicating when the anchor is approaching the boat. Some counters can be equipped with a remote control for convenient operation. Some counters can also control the windlass for deploying and retrieving to a specific length. Refer to the *Chain Counter Manufacturer's Owner's Manual* for more information.



KCB-0060





## LINES AND KNOTS

Mooring, anchor and other nautical lines are constructed from many different types of materials, and are available in many diameters and styles. Consult with your local marine supply store for a recommendation of appropriate lines for the boat and application. Commonly used mooring lines are constructed of a high-quality synthetic material in a double-braided configuration and usually have eye splices on at least one end.

Learn and become familiar with tying and using knots. Knowing how to use knots and lines properly can prevent personal injury and property damage.

Practice tying lines to docks, cleats and anchors, and connecting two lines together. Consult other qualified boaters or the boat dealer, or visit the local bookstore, library or the Internet for information on the proper use of nautical lines and knots. The following illustrations represent a few examples of securing mooring lines.

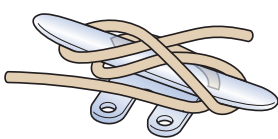

Cleating an open line

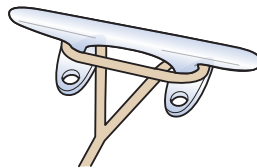

Cleating an eye-spliced line

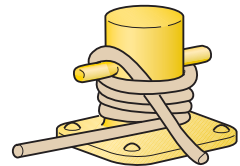

Securing to a dock bit

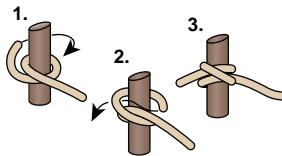

Securing load line  
(clove hitch)

A "double half hitch" should always accompany a "clove hitch" on the load line.

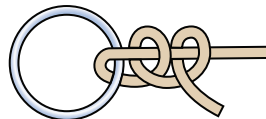

Securing load line  
(double half hitch)

KCB-0010



SECTION

7

## OPERATING THE BOAT

This Page Intentionally Left Blank

# Section 8

## TRAILERING AND LAUNCHING

Before using the trailer, review *Safety in Section 2*.

### LEGAL CONSIDERATIONS

The following information is intended as a basic guideline only. See the *Trailer Operator's Manual* for information on operation, adjustments and maintenance.

Before using the trailer, contact your state's Department of Motor Vehicles (and that of other states through which you may be traveling) for information on trailering regulations. Trailer regulations vary widely from state to state, and it is your responsibility to be in compliance with all regulations when trailering the boat.

Regulations include, but are not limited to, trailer registration, licensing, width, height, length, lights, safety chains, tie-downs, hitch type, weight capacity, brakes, spare wheels, vehicle mirrors and gross vehicle weight.

### TRAILER CLASSIFICATION

Trailers are separated into four classes based on the Gross Vehicle Weight Rating (GVWR):

TRAILER CLASS	GVWR
Class One	under 2000 lb (907 kg)
Class Two	over 2000 lb (907 kg) and under 3500 lb (1588 kg)
Class Three	over 3500 lb (1588 kg) and under 5000 lb (2268 kg)
Class Four	over 5000 lb (2268 kg)

### TRAILER TYPE

Trailers are designed for many applications and can vary in style. To prevent damage to the boat and/or personal injury, always use the appropriate trailer for proper support of the boat. Contact the dealer for more information.

## TRAILER GROSS VEHICLE WEIGHT RATING

All trailers must display a Gross Vehicle Weight Rating (GVWR) decal, which shows the load-carrying capacity plus the weight of the trailer. The total weight of the boat (fully loaded with fuel, batteries, water, etc.), engine, gear and trailer must never exceed the GVWR.

## TOWING VEHICLE

The towing vehicle must be able to safely pull the full trailer and boat load. Never pull a trailer load that exceeds the vehicle's towing capacity; you risk losing control of the trailer and/or vehicle. Before trailering, always check the *Vehicle Operator's Manual* for maximum towing/trailering load specifications and maximum gross vehicle weight specifications that include the fully loaded trailer.

## VEHICLE TOWING HITCH

The towing vehicle must be able to safely pull the full trailer and boat load. The vehicle must have a towing hitch that is capable of safely handling the trailering load and tongue weight of the trailer.

Hitches are designed for many applications and can vary in style. Use professional assistance when selecting the correct hitch and hitch ball for the towing application.

 **WARNING** *Control Hazard: A vehicle hitch that is underrated or improperly installed can lead to loss of control of the trailer and/or vehicle. Never use a hitch that is not rated to pull the maximum weight of the trailering load or that is not rated for the maximum tongue weight that the trailering load applies.*

Hitches are divided into classes that specify the trailer's gross trailer weight and maximum tongue weight for each class.

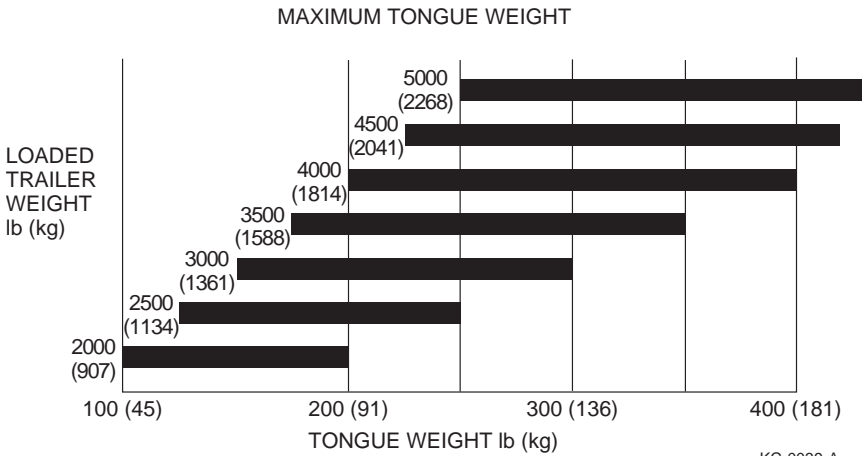

## HITCH BALL AND TRAILER COUPLER

Most boat trailers have a coupler that connects to a hitch ball attached to the towing vehicle's hitch. The trailer hitch coupler must always match the size of the hitch ball. The correct hitch ball diameter for the coupler is usually marked on the trailer coupler.

**WARNING** *Control Hazard: Never use a hitch ball size or rating that does not match the trailer coupler specifications. Using an improper size or rated hitch ball can lead to loss of control of the trailer and/or vehicle.*

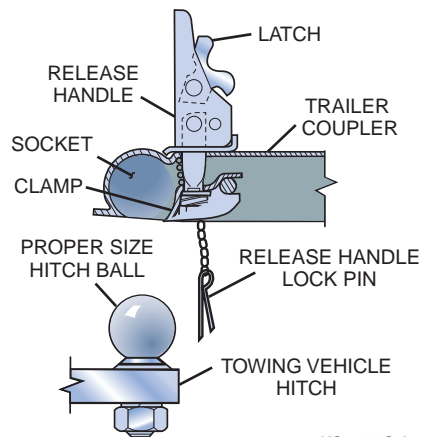



Trailer hitch balls are sized and rated for use based on the trailer GVWR:

TRAILER CLASS	GVWR	HITCH BALL DIAMETER SIZE
Class One	under 2000 lb (907 kg)	1-7/8 in. diameter size
Class Two	over 2000 lb (907 kg) and under 3500 lb (1588 kg)	2 in. diameter size
Class Three	over 3500 lb (1588 kg) and under 5000 lb (2268 kg)	2 in. diameter size
Class Four	over 5000 lb (2268 kg)	2-5/16 in. diameter size

## SAFETY CHAINS

The boat trailer's safety chains prevent the trailer from completely detaching from the towing vehicle when underway. Connect the chains to the vehicle's hitch or frame and crisscross the chains under the trailer tongue to prevent the tongue from dropping to the road if the trailer separates from the hitch ball. Rig the chains as tight as possible with enough slack to permit full-free turning. Safety chains must be rated at the same or greater weight capacity as the trailer's GVWR.

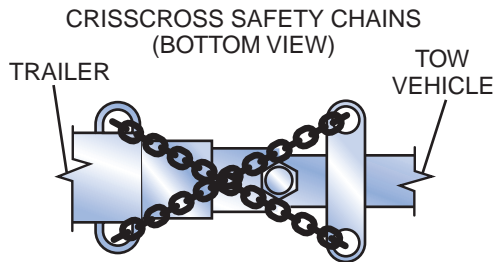

KC-0045C-A

Never allow the chains to drag on the ground when trailering.

Attach the chains properly and securely between the towing vehicle and trailer before trailering.



## TRAILER BRAKES

In some states, any trailer with a GVWR of 1500 lb (680 kg) or more is required to have trailer brakes.

Check with your state and local authorities for more information.

The three basic types of trailer brakes are electric, hydraulic surge and air-actuated. If the trailer is equipped with brakes, see the *Trailer Operator's Manual* for more information on operation, adjustments and maintenance.

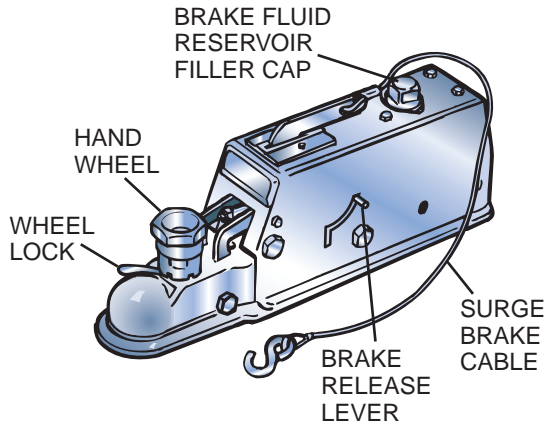

KC-0044C-B

## 5-PIN WIRING CONNECTOR

Some trailers equipped with surge brakes may utilize a 5-pin wiring connector. These trailers use an electric solenoid valve that allows brake fluid to bypass back to the reservoir while in REVERSE. The solenoid is usually connected to the reverse lights on the tow vehicle to ensure the brakes only bypass in REVERSE. The fifth pin is for deactivating the brakes when backing up, and is required to be connected to the vehicle's power when backing up.



## TRAILERING GUIDELINES

Follow these guidelines when trailering:

- Before driving, make sure the vehicle maintenance and trailer maintenance are current. This is very important because towing puts additional stress on the tow vehicle.
- Make sure the wheel lug nuts/bolts on the tow vehicle and trailer are tightened to the correct torque.
- Be sure the hitch, coupler, draw bar and other equipment that connect the trailer and the tow vehicle are properly secured and adjusted.
- Make sure all running lights, brake lights, turn signals and hazard lights are working.
- Verify that the brakes on the tow vehicle and trailer are operating correctly.
- Maintain a safe speed as regulated by the trailering laws of the state where you are traveling.
- Check the trailer and vehicle brakes for proper operation and fluid level prior to departure.
- Check the trailer for damage prior to departure.
- Make sure the hitch ball and trailer coupler are the same size and bolts and nuts are tightly secured.
- The coupler must be completely over the ball, and the latching mechanism must be locked down.
- Make sure the safety chains are properly crisscrossed and connected. They should not touch the road but should have enough slack to make turns. If the ball were to break, the trailer would follow in a straight line and prevent the coupler from dragging on the road. Make sure the trailer emergency brake cable or chain is also installed to the tow vehicle frame.
- Ensure the breakaway system lanyard is connected to the tow vehicle and not to the safety chains or ball mount.

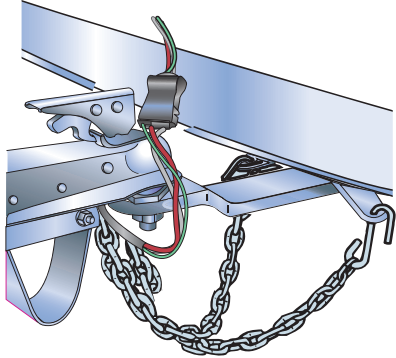

KC-0046C-A

**NOTE** — Make sure the towing vehicle and trailer are in compliance with all state and local laws. Contact your state motor vehicle bureau for laws governing the towing of trailers.



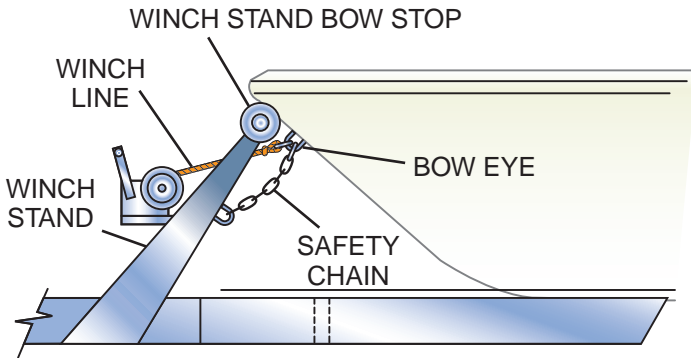

KC-0047C-A

- Once the trailer is secured to the vehicle hitch, stow the trailer jack or lift so that it will not hit the ground.
- Check and correct tire pressure on the tow vehicle and trailer, including the spare tire. Under-inflated tires heat up rapidly and may cause tire damage or failure. The proper tire pressure is listed on the trailer certification plate.
- Check trailer wheel bearings before each trip.
- Secure the stern of the boat to the trailer from the stern eyes.
- Fasten the bow of the boat to the trailer with the bow winch line connected to the bow eye and bow safety chains.
- If travel conditions require, use an additional tie-down strap across the rear of your boat from side to side to further secure the stern.
- Check all strapping material for wear.
- Check that the wiring is properly connected. It should not touch the road but should be loose enough to make turns without disconnecting or damaging the wires.
- Too much or too little tongue weight makes steering difficult and causes the tow vehicle to sway. Put approximately 5% to 10% of boat and trailer weight on the tongue.
- Drive with the vehicle and trailer running lights on.
- Check load distribution to make sure the tow vehicle and trailer are properly balanced front to back and side to side.
- Check that all items are securely fastened on and in the trailer.
- Be sure the trailer jack, tongue support and any attached stabilizers are raised and locked in place.



## TRAILERING AND LAUNCHING

- Check side-view mirrors and rearview mirrors for good visibility.
- Check routes and restrictions on bridges and tunnels.
- Keep wheel chocks and jack stands on hand.
- Side curtains, backdrop, aft curtains, convertible tops and detachable windshields are not designed to stay on boats at highway speeds. Before towing, take down the convertible top, side curtains, back cover and detachable windshield, if equipped.
- Remove any covers that are not designed to stay on boats at highway speeds.
- Carry a spare tire and wheel for both the trailer and the towing vehicle, along with tools to change them.
- See the *Engine Operator's Manual* for engine-related trailering information. Continuous road shocks may fatigue the boat's steering system.
- Tie outboard motors in place so they will not tilt or turn from road shock.
- On extended trips, carry spare wheel bearings, seals and races.
- While traveling, check the wheel hubs every time you stop. If the hub feels abnormally hot, inspect the bearing before continuing your trip.
- Carry a fire extinguisher in the vehicle.
- Turn carefully while towing a trailer; additional space and distance are needed.
- Drive slowly over railroad tracks or rough roads.
- While trailering the boat from lake to lake, boaters may unknowingly introduce a foreign aquatic species from one lake to the next. Thoroughly clean the boat below the waterline, remove all weeds and algae and drain the bilge and livewells before launching it in a new body of water.

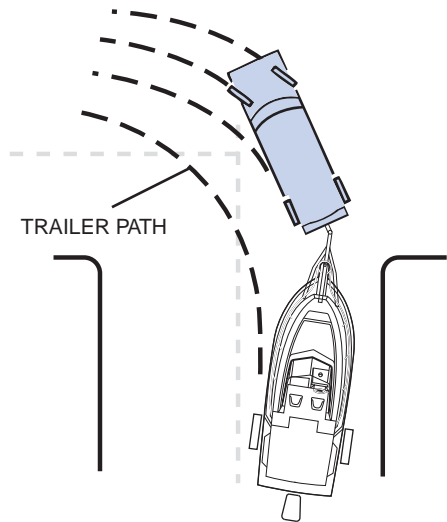

KC-0160-A



## BACKING UP

If you have never towed a trailer before, take time to practice and become comfortable with backing up the boat and trailer. Situations can arise in traffic, or when launching, that will require you to be able to back up the trailer safely.

Follow these guidelines when backing a trailer:

- Back slowly and make small steering adjustments.
- Turn the car wheels in the direction opposite where you want the trailer to go.
- After the trailer begins moving, turn the car to follow it.
- Have a second person assist you with audible and hand signals.

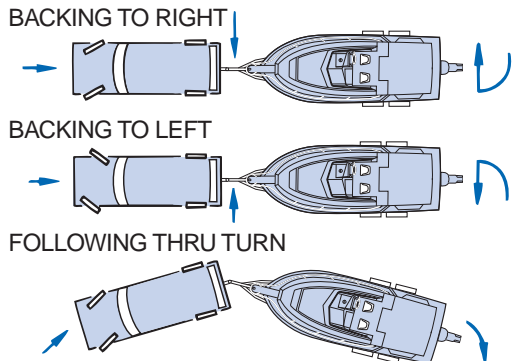

KC-0266-A

## LAUNCHING

Before launching, inspect the launch ramp for any problems that may hinder launching or make launching unsafe. Ramps can be slick and dangerous to drive or walk on, and may have unseen drop-offs beneath the water that would pose a safety hazard. Always be aware of water conditions and the effects of the wind when launching.

Before launching, inspect the boat and trailer for damage. Do not launch if you detect damage or find that the engine or propeller is not in good operating condition. Have any repairs made before launching.

Use courtesy when preparing the boat for launching by preparing away from the ramp on level ground before proceeding to the launch ramp.

When launching the boat on the trailer, have two or more people assist you. Since all launches are different, the following procedures are intended as guidelines only:

- Verify that the vehicle's brakes, including the parking brake, are in proper working order.
- Make sure the trailer is securely fastened to the vehicle.
- Remove the boat cover, if equipped.



## TRAILERING AND LAUNCHING

- Check that the bilge drain plug is in place and all other plugs that allow water to leak into the boat are in place.
- Remove all tie-downs from the boat.
- Attach the bow and stern docking lines.
- Attach boat fenders if necessary.
- Disconnect the trailer's light harness from the car.
- If applicable, trim or tilt the engine/outdrive up to avoid damage.
- Make sure the bow winch and strap are securely locked and fastened.
- Make sure the bow winch safety chains, if equipped, are in place.
- Make sure all required documentation and safety equipment are on board.
- Verify that batteries are fully charged and in good condition.
- Check fuel level; add fuel if necessary.
- Always launch with the help of another person.
- Make sure there is no one on the ramp behind the boat.
- Keep the trailer/vehicle combination as straight as possible and at 90 degrees to the shoreline.
- Back slowly down the ramp until the transom of the boat is a few inches in the water; then stop the vehicle.
- Stop the vehicle and shift into PARK (automatic transmission) or REVERSE (manual transmission). Apply the brakes and/or parking brake. If possible, use wheel blocks.
- Position the mooring lines within reach of the dock.
- Disconnect the bow winch strap and safety chains, if equipped, from the bow eye.
- Manually back the boat clear of and off the trailer into the water and secure to the dock using mooring lines.
- Remove any wheel blocks and release the vehicle brakes. Pull the trailer slowly out of the water, and secure and park in a designated area.
- Board the boat.
- Lower the engine/outdrive, if applicable.
- Run the bilge blowers as required, if equipped.
- See the *Engine Operator's Manual* for starting procedures.
- Remove dock lines from the dock and proceed slowly away from the dock.



## LOADING GUIDELINES

Follow these guidelines while loading the boat onto the trailer:

- When loading the boat on the trailer, have two or more people assist you.
- Stop, turn off the engine and secure it to the dock with dock lines at a position clear from where the trailer will be in the water.
- If applicable, trim or tilt the engine/outdrive up to avoid damage.
- Verify that the vehicle's brakes, including the parking brake, are in proper working order.
- Disconnect the trailer's light harness from the tow vehicle.
- Make sure the trailer is securely fastened to the vehicle.
- Back the trailer slowly down the ramp until it is positioned so that the boat can be loaded.
- Stop the vehicle and shift into PARK (automatic transmission) or REVERSE (manual transmission). Apply the brakes and/or parking brake. If possible, use wheel blocks.
- Position the mooring lines within reach of the dock.
- Manually position the boat onto the trailer using mooring lines. Make sure it is centered on the supports of the trailer.
- Position the bow eye into the bow stop and connect and secure the bow winch strap and safety chains, if equipped, to the bow eye.
- Secure the mooring lines inside the boat.
- Remove any wheel blocks and release the vehicle brakes. Slowly pull the trailer and boat up the ramp.
- Secure the transom to the trailer.
- Prepare for trailering as necessary.

## REPORTING SAFETY DEFECTS

If you believe that your boat trailer has a defect which could cause a crash or could cause injury or death, you should immediately inform the National Highway Traffic Safety Administration (NHTSA) in addition to notifying the trailer manufacturer.

If NHTSA receives similar complaints, it may open an investigation, and if it finds that a safety defect exists in a group of trailers, it may order a recall and remedy campaign. However, NHTSA cannot become involved in individual problems between you, your dealer or the boat manufacturer.

To contact NHTSA, you may call the Vehicle Safety Hotline toll-free at 1-888-327-4236 (TTY: 1-800-424-9153); go to <https://nhtsa.safercar.gov>; or write to Administrator, NHTSA, 1200 New Jersey Avenue SE, Washington, DC 20590. You can also obtain other information about motor vehicle safety from <https://www.safercar.gov>

## Section 9

# BOAT FEATURES AND OPTIONS

Before operating any systems within this section, review *Safety in Section 2*.

The boat may be equipped with a variety of systems to operate the boat and to provide other conveniences you may need while on the water. The following basic and typical information may not apply to your specific application. All of the boat's systems may not be covered in this section. See the *Equipment Manufacturer's Operator's Manual* for specific details.

Regularly inspect and maintain all components and systems to prevent unexpected hazards due to worn or faulty components. Be sure to replace components and hardware with marine-grade parts.

** WARNING** *Fire/Explosion Hazard: Never use parts not specified for marine use to replace marine-grade parts. Using non-marine specified parts in a marine environment may result in a fire and/or explosion.*

## FUEL SYSTEM

The basic fuel systems consist of one or more fuel tanks, tank vents, level sensor and gauge, lines, pumps and valves.

Each tank has an antisiphon valve to prevent fuel from leaking out of the tank should a break occur in the system at a point other than the tank. Some models are also equipped with a fuel shutoff valve at each tank to stop fuel flow from the tank. It is recommended that fuel shutoff valves be closed during long periods of inactivity or storage. If equipped with multiple tanks, the system also includes a fuel tank selection valve for individual tank selection and a fuel manifold. The manifold is usually located in the engine compartment and contains a series of fuel feed valves for controlling fuel flow/shutoff to the engines. The fuel valves can be used to help maintain even weight distribution in the fuel tanks for proper boat load distribution or to shut off contaminated fuel from the system. Refer to the boat and *Engine Operator's Manual* for specific fuel system information and service information.



## ENGINE EXHAUST SYSTEM

The engine exhaust system vents engine exhaust gases away from the boat. Inboard engines have a muffler and may use water injection as part of the exhaust system. Some stern drives have an exhaust diverter valve that, when activated, routes engine exhaust to thru-transom exhaust pipes or down through the propeller hub. Use thru-transom exhaust only when your boat is well offshore. Never change or modify the standard manufactured exhaust system. See the *Engine Operator's Manual* for engine exhaust system and service information.

## ENGINE LUBRICATION SYSTEM

Depending on engine type, the boat may feature one of several engine lubrication systems. Many small-to-mid-range two-cycle outboards are lubricated by oil mixed directly with the gasoline in the fuel tank, while other two-cycle outboards may be equipped with an oil injection system. In each system, the oil is consumed as the engine runs. Oil injection systems include a separate reservoir for oil containment and an oil pump or combination fuel/oil pump that supplies oil to the fuel system for engine lubrication. Four-cycle outboards and sterndrive engines, like automotive, use a sump system where the engine oil is contained in the engine. See the *Engine Operator's Manual* for engine oil recommendations and information.

## ENGINE COOLING SYSTEM

Some boat engines and transmissions are cooled by the transfer of heat from the continuous flow of cool sea/lake (raw) water through the engine or transmission cooling passages and then back into the sea/lake. A raw water pickup and screen on the lower drive unit or hull allows water into the engine, and a pump then circulates the water to cool the engine.

Some boat engines and transmissions are cooled by heat transfer from the continuous flow of engine coolant through a self-contained cooling system. The cooling system has a large heat exchanger that transfers heat from the engine to the coolant. Raw water flows through a separate passage in the heat exchanger to transfer heat from the self-contained engine coolant to the raw water and back into the sea/lake.

Raw water intakes on the hull or any water outlet below the boat's waterline usually feature a seacock that provides a manual shutoff during a leak. Be sure to periodically inspect the raw water intake screen and clear it of any debris that could obstruct water flow into the engine. Keep seacocks located at the thru-hull fitting closed during long periods of inactivity; open them only when needed.



**NOTICE**

Keep seacocks closed during periods of inactivity. A downstream hose failure could flood your boat if the seacock is left open.

TYPICAL SEACOCK AND STRAINER

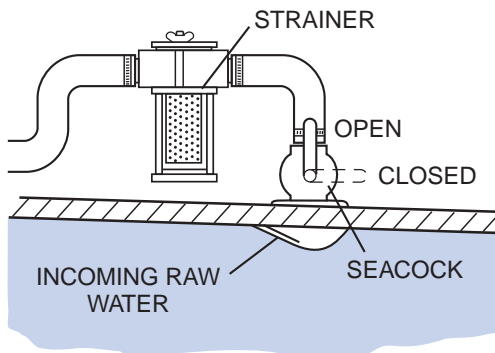

KC-0189-A

## ELECTRICAL SYSTEM

Boats may be equipped with one or two types of electrical systems: Direct Current (DC) and Alternating Current (AC).

Most boats use a battery-powered direct current (DC) system; some boats also use a generator or shore-powered alternating current (AC) system. Most systems have a main load panel which serves as the main distribution panel.

### DC SYSTEM

Most boats use a 12-volt common negative ground DC system. DC systems are usually the primary electric supply for lights, pumps, blowers, engine starting, etc.

Boats require at least one battery per engine. Multiple-battery systems consist of a cranking battery for each engine and additional batteries that supply auxiliary power to DC electrical circuits.

Battery switches control battery power distribution and disconnect the batteries from the boat's electrical system. The engine's charging system charges batteries connected to the charging system when the engines are running.



## BOAT FEATURES AND OPTIONS

Battery isolators prevent accessory loads and other batteries from depleting power from charged batteries. Isolators also allow the engine's charging system to isolate the alternator charging output and distribute the charge among all batteries according to individual need.

The main DC control panel may feature a voltmeter, battery test switch, fuses, circuit breakers and a master breaker switch.

**⚠ WARNING** *Fire Hazard: Never reset a breaker that has been automatically tripped without first identifying and correcting the cause of the problem. A fire could result.*

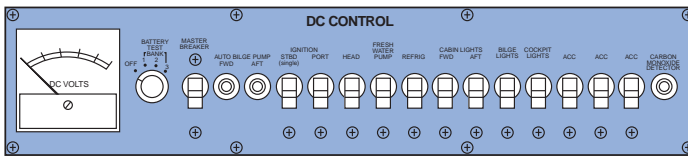

TYPICAL DC CONTROL PANEL

KC-0155-A

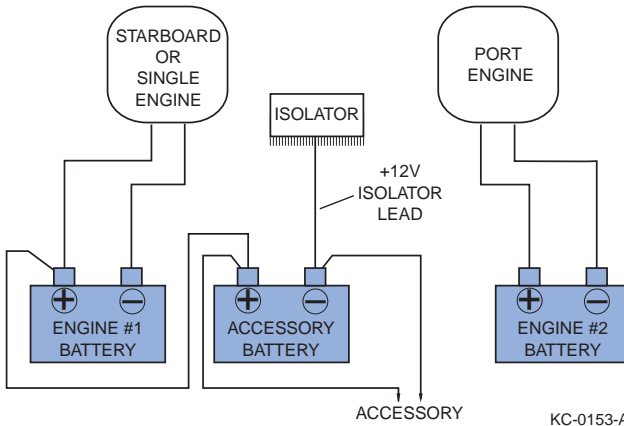

KC-0153-A



## AUTOMATIC CHARGING RELAY (ACR)

Models equipped with an ACR automatically connect or isolate the engine starting and accessory house batteries as needed. Under normal conditions the starting batteries are isolated from the house batteries to prevent house battery discharge. If additional power is required for starting, the ACR automatically combines starting and house batteries but temporarily isolates other electronics for protection. The ACR also automatically combines batteries for charging from either starting or house battery charge sources.

## AC SYSTEM

AC systems supply AC electrical power to equipment and outlets requiring AC power, such as electric stoves, water heaters, microwaves and refrigerators. AC systems are normally used when your boat is moored to a dock or slip. AC systems rely on shore power or on-board AC generators.

### **NOTICE**

*NEVER modify or repair a boat's AC power system or components. Always consult a qualified electrician and ensure that repairs or modifications are in compliance with ABYC guidelines and National Electrical Codes.*

AC shore power systems are normally rated for 125 volts at 60 cycles. Source current is provided by a 110-volt, 60-cycle shore power station.



The AC control portion of the AC generator control panel may include the following components:

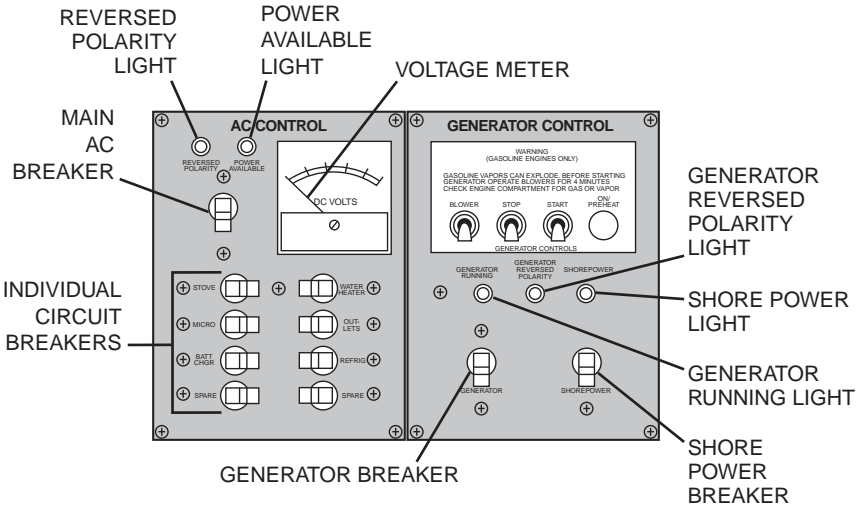

TYPICAL AC/GENERATOR CONTROL PANEL

KC-0156-A

**Voltmeter**

The voltmeter allows you to monitor the system AC voltage. Damage to components can occur if voltage entering the system is less than the minimum operating voltage.

**Reverse Polarity Light**

The reverse polarity light indicates if the polarity of the shore power source has been reversed, but will not indicate if the boat polarity (wiring) is reversed.

**! WARNING** *Electrical Hazard: If a reverse polarity warning is indicated, do not use the shore power source. Immediately turn off the power source onshore and disconnect the shore power cord. An electrical hazard exists and must be corrected before using shore power.*



## Power Available Light

The power available light indicates that power from the shore or from the generator is available to the panel for distribution. This indicator must be illuminated before you switch the main AC breaker on.

## Main AC Circuit Breaker

Main AC circuit breaker provides overload protection for all circuits on the panel and allows the connection and disconnection of AC power to all individual circuits.

## Individual Circuit Breakers

Individual circuit breakers provide overload protection for an individual circuit and allow the connection and disconnection of AC power to individual circuits.



## **WARNING**

***Fire Hazard: Never reset a breaker that has been automatically tripped without first identifying and correcting the cause of the problem. A fire could result.***

## Generator Main Circuit Breaker

The generator control portion of the AC generator control panel may include the following components:

Generator main circuit breaker provides overload protection for all circuits on the panel and allows the connection and disconnection of generator AC power to all individual circuits. Never switch the breaker while the generator is running.

## Shore Power Circuit Breaker

The shore power circuit breaker provides overload protection for all circuits on the panel and allows the connection and disconnection of AC shore power to all circuits.

## Generator Running Light

The generator running light indicates that generator power is being received by the AC control panel.

## AC Shore Power Light

The AC shore power light indicates that shore power is being received by the AC generator control panel.

## SHORE POWER

**DANGER****Electrocution Hazard:**

- *Always use a shore power cable that is in excellent condition and with no cuts, nicks or abrasions in the exterior plastic cover. Electrical shock can occur from use of a damaged shore power cord.*
- *Never allow the end of the shore power cable to hang in the water. An electrical field can result, causing danger to nearby swimmers.*
- *Never swim or allow others to swim anywhere near the boat when the boat is connected to shore power. Stray voltage may leak from the shore power cable and/or boat shore power connector.*

**WARNING****Electrical Shock/Fire Hazard: To minimize shock and fire hazard:**

- *Examine the shore power cable for damage. Never use the shore power cable if it appears cut or damaged.*
- *Turn off the boat's shore connection switch before connecting or disconnecting the cable.*
- *Connect the shore power cable to the boat's inlet before connecting to the shore power source.*
- *If the boat is equipped with a polarity indicator that activates, immediately disconnect the shore power cable.*
- *Disconnect the shore power cable at the shore outlet first. Never leave the shore power cable connected to the shore outlet when the cable is not in use.*
- *Close the shore power inlet cover tightly.*
- *Never alter the plug and connector on the shore power cable. Use only compatible cable connectors and shore power receptacles.*

**WARNING****Fire Hazard: Never supply power to the water heater when it is empty. Fire may result if the heating element is damaged.****NOTICE**

*When extending shore power cables, be sure that there is enough slack in the cable at all times to account for the movement of the boat in its slip (side-to-side tidal action). If the shore power cable is held too tight, it may damage the cable.*

# BOAT FEATURES AND OPTIONS

All shore power systems require a special marine-grade, three-conductor cable to make a proper connection to the shore. Cables and connection types are rated by their current-carrying ability in amperes. Dockside connections are plug-in, while boat-side connections plug in and lock into position with a threaded locking collar to prevent accidental disconnection and to provide water resistance. Always obtain authorized assistance when selecting cables and adapters, or when connecting to power.

Each time you plug into an unfamiliar shore station, inspect the outlet for signs of corrosion or damage before using it. Establish that the receptacle is correct for the cable and ensure the plug fits snugly and securely into the receptacle. If the shore power cord should ever feel warm to the touch when the power is on, follow instructions on how to disconnect the shore power cord and report the problem to the marina authorities.

## SHORE POWER CABLE CONNECTIONS

### Receptacle & Connector - Locking & Grounding

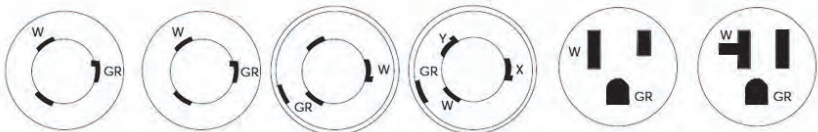
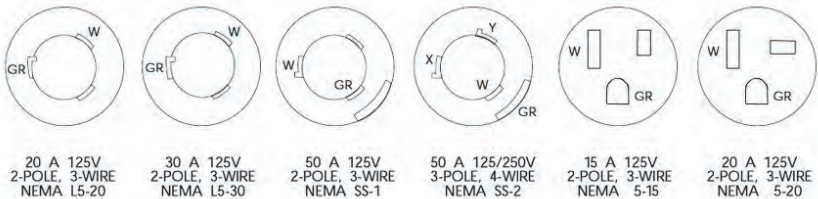

### Plug & Inlet - Locking & Grounding

Wiring: GR = green W = white X, Y, Z = other colors, including black

KC-6016



## BOAT FEATURES AND OPTIONS

Use the following guidelines to minimize shock and fire hazards when connecting and disconnecting shore power cables.

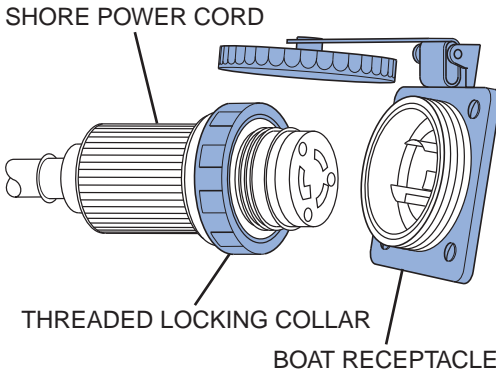

BOAT-SIDE SHORE POWER CONNECTION

KC-0179-A

### To connect:

- Shut down the generator if applicable. Turn off the generator breaker and the main AC breaker.
- Turn off your boat's main AC breaker switch.
- Turn off the dock or shore outlet switch.
- Connect the shore power cable to the boat connection.
- Make sure the cable has more slack than the mooring lines and cannot drop into the water.
- Remove the cap from the outlet on the pier and connect the other end of the shore cable to the outlet on the pier.
- Turn on the dock or shore outlet switch.
- Check the reversed polarity light. If it is on, immediately disconnect the cable.
- Turn the AC main or shore circuit breaker switch to the ON position.
- Turn the AC main panel circuit breaker switch to the ON position.
- Turn individual circuit breakers on.



**To disconnect:**

- Turn the AC main panel circuit breaker switch to the OFF position.
- Turn the AC main or shore circuit breaker switch to the OFF position.
- Turn off the dock or shore outlet switch.
- Disconnect the shore power cable at the shore outlet.
- Disconnect the power cable from the boat. Replace the cap over the inlet.
- Place the cable in storage for future use.

**⚠ WARNING** *Shock Hazard: Some marinas have been known to “break” shore power ground circuits to prevent electrolysis. Opening the ground circuit creates a potentially dangerous on-board shock hazard. Ensure that your shore power cable ground circuit is always continuous.*

**GENERATOR**

Generators can be used to supply AC electrical power to the boat’s electrical system. Generators typically use the same type of fuel as the propulsion unit. Follow the generator manufacturer’s information for operating instructions.

**⚠ WARNING** *Fire/Explosion Hazard: Gasoline is extremely flammable and highly explosive under certain conditions. Handle gasoline with caution.*

Generators produce carbon monoxide (CO) gas when operating. Install a CO detector in the cabin area of your boat and be sure it works properly when you are using the generator.

**⚠ DANGER** *Exhaust Hazard: Carbon Monoxide (CO) is a colorless and odorless gas that will cause death or serious injury.*

**To reduce CO accumulation:**

- Do not operate the generator with the canvas installed.
- Avoid idling or using the generator while at idle for extended periods.
- Regularly inspect the generator’s exhaust system for proper operation.
- Do not use the generator or any fuel-burning appliances with a transom exhaust port when anyone is swimming from a stern swim platform.



## ELECTRONIC LEAKAGE CIRCUIT INTERRUPTER (ELCI)

On boats with shore power, the AC electrical system is also equipped with an electronic leakage circuit interrupter (ELCI) which will open (trip) under dangerous conditions. This situation can occur when there is a combination of a ground fault and a faulty ground, and is a hazard to both people in the boat and in the water. The ELCI is installed near the boat's shore power connector inlet and provides whole-boat protection for everything downstream of it. Some ELCI panels are equipped with a reverse polarity indicator; if the indicator is illuminated, turn off the main breaker, disconnect the shore power cord and notify the marina master of the fault. AC outlets are further protected with marine-grade ground fault circuit interrupters (GFCI) for protection in potentially wet environments.

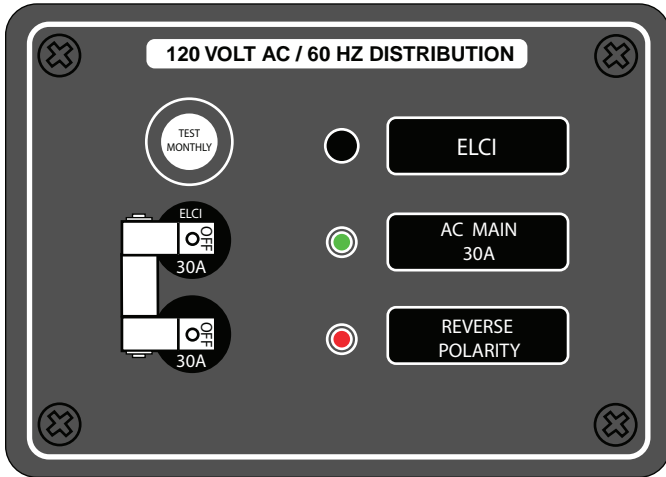

KC-6004

It is important that the ELCI is working properly to provide protection against Electric Shock Drowning (ESD). The boater should test the ELCI at least once each month to ensure proper operation by pressing the test/reset buttons in the faceplate. Refer to the ELCI manufacturer's instructions for testing details and fault codes. For more information go to: [www.esfi.org/resource/boating-and-marina-safety-263](http://www.esfi.org/resource/boating-and-marina-safety-263)

**DANGER*****Electrocution Hazard:***

- ***To reduce the possibility of an electrical shock, it is important that the AC ground system is functioning properly and that a proper connection exists between the shore power cord, the shore power inlet, the boat bonding system and the outlet ground circuits. If there is any doubt about the integrity of the ground circuit, contact a qualified marine electrician immediately. The AC power should be disconnected until the necessary repairs are completed.***
- ***Reversed polarity and ground fault conditions will damage the system and expose passengers to electrocution hazards that will cause severe injury or death. This condition could also cause a fire in the electrical system. Never operate the AC electrical system with reversed polarity or a ground fault condition.***
- ***Electric shock can cause severe injury or even death. Do not attempt to correct the wiring yourself. Always have a qualified electrician check wiring. Keep children away from any electrical cables or equipment and always use grounded appliances on board the boat. Undetected faults in the AC electrical system could cause the water around the boat to become energized. This could cause a severe shock or even death to someone in the water near the boat. Never swim or allow swimming around the boat when the AC system is activated by the shore power connection or the generator.***



## INVERTER/CHARGER

The boat may be equipped with an inverter/charger, which is a combination of a DC-to-AC inverter, battery charger and transfer switch. When AC power is available (shore power or generator), the unit recharges the house batteries. It also allows surplus AC power to pass through and power downstream AC loads. When AC power is disconnected, the unit inverts the DC power of the house batteries to AC power. Some models may be equipped with a remote monitor panel or may be connected to an MFD through an NMEA 2K network.

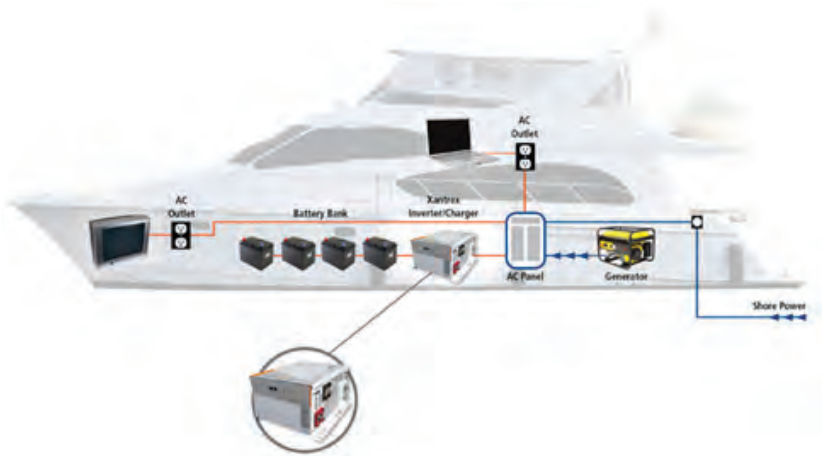

KCB-0063

## GROUND FAULT CIRCUIT INTERRUPTERS

Each AC receptacle is protected by a Ground Fault Circuit Interrupter (GFCI). The GFCI measures both the amount of current flowing to the circuit's receptacles and the amount of current returning from the receptacles. The GFCI compares the two values once measured. If the values are not the same, the GFCI instantly trips, and power is shut off to the receptacles.



### Testing GFCI Receptacles

GFCIs have TEST and RESET buttons located on the receptacles.

Switch the TEST button ON/OFF switch to ON to reset a GFCI that has tripped.

Press the RESET button to reset the GFCI after it has tripped. Resetting a GFCI allows electricity to flow again to the receptacle.

Test each GFCI circuit once per week.

**⚠ WARNING** *Shock Hazard: Never use a GFCI or any receptacle on a GFCI circuit if power is still available on that circuit after the test button has been pressed. Death or serious injury can occur by receiving an electrical shock from the AC electrical system including the Ground Fault Circuit Interrupter (GFCI) receptacle. Seek immediate medical attention after receiving an electrical shock. Contact a qualified electrician to make appropriate repairs.*

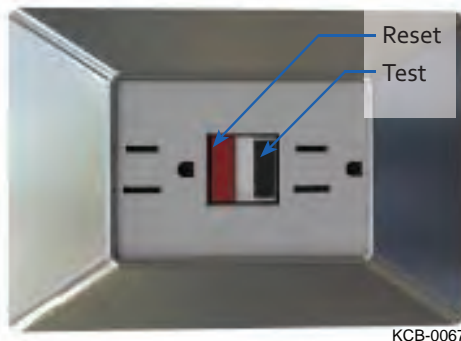

1. Press the TEST button. If operating normally, it cuts the electricity to the receptacle on the GFCI.
2. Plug a lamp or other AC-powered device into the receptacle and turn ON the device. The device should NOT operate.
3. Press the TEST button. Never use the receptacle if the receptacle still has power. Contact a qualified electrician to make the appropriate repairs.
4. Reset the GFCI to restore power to the receptacle.



## SHIFT AND THROTTLE CONTROLS

Knowing how to operate the shift and throttle controls of the boat is essential for safe and proper operation.

The following basic and typical information may not apply to your specific shift control. See the *Engine Operator's Manual* or control manufacturer's instructions for information on your throttle and shift control operation, adjustment and maintenance.

**⚠ WARNING** *Control Hazard: Always use extreme caution when using a single-lever binnacle control. These controls may not have a neutral lockout position or a neutral detent. These controls can accidentally move from Forward to Reverse or Reverse to Forward easily. This could result in a control hazard.*

### SINGLE-LEVER CONTROLS - SINGLE OR TWIN ENGINE

Single-lever controls operate both the gear shift and the throttle for one engine with one control lever. Single-lever controls can be used on single- or twin-engine boats.

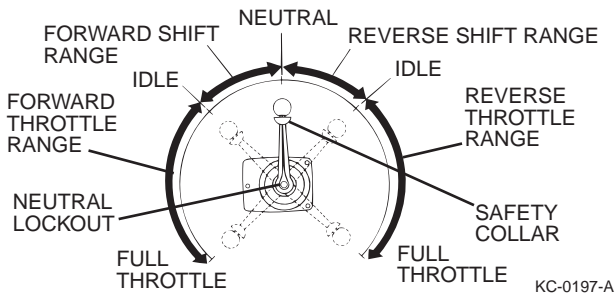

## BOAT FEATURES AND OPTIONS



Twin-engine boats with single-lever controls have two levers: a left lever for port engine control and a right lever for the starboard engine. Two levers enable you to operate one engine in FORWARD and the other in REVERSE for easier maneuvering in tight quarters.

**NEUTRAL** - The lever is detented in the NEUTRAL position (center of travel) for starting; the neutral safety switch allows starting in this position only. For engine warm-up, a separate lever or button on the control is used to disengage the shift cable and allow the throttle to advance only while the transmission remains in NEUTRAL.

**FORWARD** - Release the detent lock to allow shifting to the FORWARD position. Moving the lever into the first 15 degrees of travel (toward the bow or up) positions the control in the FORWARD detent IDLE position. Advancing the lever beyond 15 degrees allows throttle increase in FORWARD.

**REVERSE** - Release the detent lock to allow shifting to the REVERSE position. Moving the lever into the first 15 degrees of travel (toward the stern or down) positions the control in the REVERSE detent idle position. Advancing the lever beyond 15 degrees allows throttle increase in REVERSE.

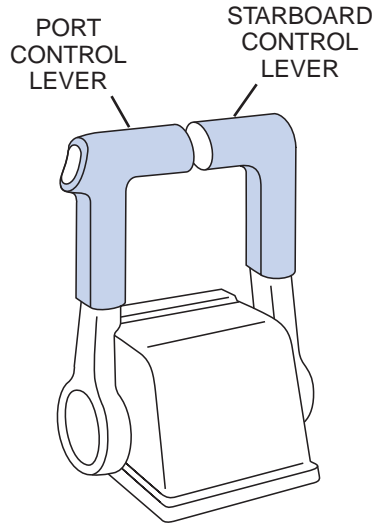

KC-0093-A

### DUAL-LEVER CONTROLS - SINGLE OR MULTIPLE ENGINE

Dual-lever controls have individual levers for gear shifting and engine throttle. Dual-lever controls can be used on single- or twin-engine boats.

Shift levers: NEUTRAL is the detent position in the center of the lever's travel. Pushing the lever toward the bow or up shifts the transmission into FORWARD; pulling the lever toward the stern or down shifts the transmission into REVERSE.

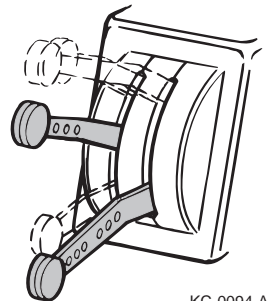

KC-0094-A

## CONTROL OPERATION GUIDELINES

**⚠ WARNING** *Control Hazard: Improperly maintained controls are hazardous and may cause sudden loss of control. Make sure all shift/throttle hardware and cables are regularly inspected and maintained. Improper maintenance may result in a loss of control.*

- Side mount throttle and shift controls have a neutral detent locking lever that must be released before shifting from NEUTRAL.
- Always use a brisk and decisive movement when shifting into or out of gear.
- Always pause in NEUTRAL before shifting from FORWARD to REVERSE, or REVERSE to FORWARD. Most throttle and shift controls have a detent position for NEUTRAL, FORWARD and REVERSE engagement positions. Engine damage may occur if you rapidly shift into gear without pausing in these detent positions or allowing the engine RPM to lower into the approved shifting range.
- When traveling at high speed, never shift into REVERSE while your boat is in FORWARD gear.
- Always keep the shift control clean and clear of obstructions.

**NOTICE** *All shift and throttle controls are equipped with a safety switch for start-in-gear prevention. Place the control in the NEUTRAL position before you attempt to start the engine.*

- Never attempt to shift when the engine is not running.

## ELECTRONIC STEERING SYSTEM

The boat may be equipped with an optional electronic steering system. Most systems use a helm-mounted unit with a steering wheel that controls a cylinder mounted to the drives, outboards or rudder. The steering wheel can be tilted by activating the tilt lock lever located on the bottom side of the helm unit and automatically locks when released at or close to that angle.

Electronic or steer-by-wire systems consist of an electronic helm unit, helm-mounted display screen, aft-mounted pump control module, aft-mounted hydraulic pump/reservoir and drive/rudder-mounted hydraulic cylinder. The electronic components communicate over a data network to control the hydraulic pump to operate the cylinder and steer the boat. The steering pumps have an integral service valve that can be opened to bypass the pumps for service or in case of emergency. Refer to the *Steering Manufacturer Owner's Manual* for more information.





Most electronic steering systems allow for multiple stations and easy integration with NMEA 2K-compatible joystick controls and autopilots. These systems can be dealer-programmed to adjust outboard engine-toe and turning ratio and contain built-in redundancy and safety features.

**NOTICE**

*The drives must be aligned to provide maximum stability on straight-ahead runs and proper tracking through cornering. Damage to the drives or steering system may require the drives to be realigned by the dealer. Refer to the Drive Manufacturer's Owner's Manual for specific information.*

**PROPELLERS**

The following basic information may not apply to all engines. See the *Engine Operator's Manual* for information on propellers for the boat. Consult the boat dealer for assistance when replacing or servicing propellers.

The propeller converts the engine's power into the thrust needed to propel the boat. Care and selection of the propeller is very important for proper boat operation. Propeller size is usually identified by two numbers, such as 13 x 19, and a material identification, such as aluminum or stainless steel. In the number sequence, the first number is the diameter of the propeller in inches and the second is the pitch in inches.

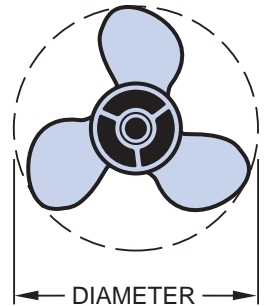

KC-0149-A



## BOAT FEATURES AND OPTIONS

Pitch is the angle of the blades expressed in the theoretical distance a propeller travels in each revolution. In the previous example, the pitch is 19, which means that each revolution of the propeller pushes the boat 19 inches (483 mm) through the water.

Propellers on boats powered by outboard or sterndrive propulsion systems are usually replaced out of the water to prevent loss of parts and to ensure correct installation.

Although propeller replacement can be completed with the boat in the water, it is not recommended. Remove an inboard-powered boat from the water for propeller replacement because the propeller is not accessible while the boat is in the water. Special tools are required for most applications. Always consult the boat dealer for assistance when replacing or servicing propellers.

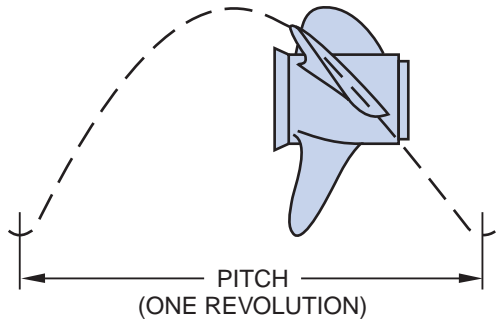

KC-0150-A

### PROPELLER SELECTION AND REPLACEMENT GUIDELINES

There are many different propeller designs for specific operating characteristics. Always consult a certified marine technician when replacing your propeller.

To prevent accidental start-up, complete the following before installing or removing the propeller:

- Position the shift control in NEUTRAL.
- Position the battery switch to the OFF position and remove the key.
- Place a wood block between the cavitation plate and the propeller to hold the propeller in place. Remove the propeller nut.

**WARNING**

***Personal Injury Hazard: Never use your hand to hold the propeller when removing the propeller nut; the propeller blades are sharp. Wear protective gloves.***



## DUAL-PROP DRIVES

Many sterndrive and some outboard-powered boats may use a dual-prop drive. Dual-prop drives have one prop turning clockwise and the other prop turning counterclockwise. Dual-prop drives come in rear-facing (sterndrive/outboard) and forward-facing (pod) designs. With either design the forward prop (referenced to the bow of the boat) turns counterclockwise while the rear prop turns clockwise.

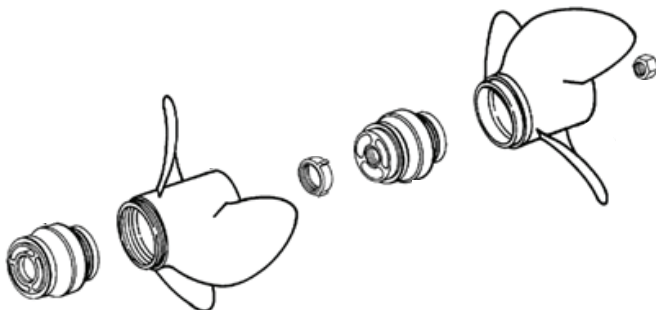

KCB-0012

In dual-prop drives, either prop can have three or four blades and have different pitches and/or diameters. Some configurations can increase top speed at the expense of fuel economy. Always treat the propellers on dual-prop drives as a set and change them out as a set even if only one is damaged. Read the drive manufacturer's owner's information carefully and consult the dealer or a marine propeller specialist for assistance.

## DISPLAY PANELS

The boat may be equipped with one or more display panels, sometimes referred to as a multi-function display (MFD) or cockpit display. Panels are available in different sizes and can be dedicated to a single function, such as switching, or can be multi-functional for engines, navigation systems, etc. Some displays allow side-by-side or four-quadrant display of information at the same time. Panels can also be dedicated to the propulsion system and can duplicate other helm controls.

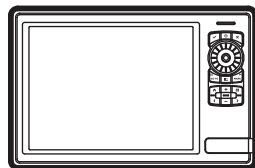

KC-5026

Operation of the displays can vary by type, brand, and installed options; read the display operation information and control-specific user manuals for proper use. Consult the boat dealer, who is often the best source when it comes to making an informed decision on adding or integrating display panels.



Display panels and some electronic controls can also integrate one or more optional capabilities such as:

- Engine/systems information display
- Embedded Wi-Fi/Bluetooth/remote control operation
- Radar/sonar/fish finder
- GPS/autopilot/navigation/chartplotter
- Station keeping
- Cruise/tow/trim control
- Second station/joystick operation
- VHF/AIS/DSC
- Video/camera/thermal image display
- Digital switching/stereo

Some options can be retrofitted if the NMEA 2K network is in place, but it is dependent on the propulsion/display manufacturer. The dealer is the best source of information.

**⚠ WARNING** *Multi-function display panel features and options are only tools to assist skippers with operation. Use of these tools does not relieve the skipper of the responsibility to safely operate the boat.*

- *Never leave the helm unattended and be prepared to quickly regain helm control should a situation arise.*
- *Never operate the boat while watching video. Distracted driving while the boat is moving is extremely dangerous.*
- *Units with GPS are a navigational aid only and cannot be used for precise measurement of direction, distance, location or topography.*

## BOAT MONITORING SYSTEMS

Boaters who keep their boat in the water may want to look into a boat monitoring system. There are a variety of systems available and each has unique installation, monitoring, notification, security abilities and price points. Typical systems help protect against theft, high water, fire/smoke, intrusion and loss of shore power. The best systems offer an independent power supply, hidden installation and satellite tracking and surveillance capabilities. The dealer is the best source for information on these systems.



## ELECTRONIC STEERING SYSTEM

The boat may be equipped with an optional electronic steering system. Most systems use a helm-mounted unit with a steering wheel that controls a cylinder mounted to the drives, outboards or rudder. The steering wheel can be tilted by activating the tilt lock lever located on the bottom side of the helm unit and automatically locks when released at or close to that angle.

Electronic or steer-by-wire systems consist of an electronic helm unit, helm-mounted display screen, aft-mounted pump control module, aft-mounted hydraulic pump/reservoir and drive/rudder-mounted hydraulic cylinder. The electronic components communicate over a data network to control the hydraulic pump to operate the cylinder and steer the boat. The steering pumps have an integral service valve that can be opened to bypass the pumps for service or in case of emergency. Refer to the steering manufacturer owner's manual for more information.

Most electronic steering systems allow for multiple stations and easy integration with NMEA 2K-compatible joystick controls and autopilots. These systems can be dealer-programmed to adjust outboard engine-toe and turning ratio and contain built-in redundancy and safety features.

### NOTICE

*The drives must be aligned to provide maximum stability on straight-ahead runs and proper tracking through cornering. Damage to the drives or steering system may require the drives to be realigned by the dealer. Refer to the Drive Manufacturer's Owner's Manual for specific information.*

## ELECTRONIC PROPULSION CONTROLS

The boat may be equipped with optional electronic controls for the propulsion units. These controls communicate digitally over an NMEA 2K or CANBUS network and replace mechanical ignition, throttle and shift controls. Most units support multiple propulsion units and operation stations. Refer to the *Propulsion Manufacturer Owner's Manual* for more information.



## STABILIZER

The boat may be equipped with a stabilizer option to significantly reduce boat roll. Controls for the stabilizer can vary by type; read the stabilizer operation information for proper use.



KC-6002

## BOW THRUSTERS

The boat may be equipped with a bow thruster option to aid in docking. Controls for the thruster can vary by type; read the thruster operation information for proper use.

Most bow thrusters use a joystick control. With the engines in NEUTRAL, enable the bow thruster by turning it on and then move the joystick control in the desired direction (port or starboard) and the bow will move accordingly. Some bow thrusters do not have variable speed and require short “bursts” of thrust. Bow thrusters can be used in combination with the primary propulsion, but practice in open water to get a feel for how it works.

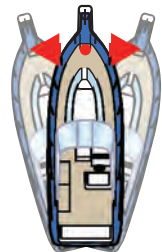

KC-6010

## JOYSTICK CONTROLS

**⚠ WARNING** *Control Hazard: Always use extreme caution when using a joystick control. These controls may not have a neutral lockout position or a neutral detent. These controls can accidentally move from Forward to Reverse or Reverse to Forward easily. This could result in a control hazard.*

The boat may be equipped with an optional joystick control that works in conjunction with electronic steering and propulsion controls. Joystick controls provide precision maneuverability for docking and slow-speed navigation, such as in a marina, and may offer other optional functions. Practice using the joystick in open water away from traffic to get the feel of the control. Refer to the joystick/propulsion manufacturer owner's manual for more information.



KC-5025



## AUTOMATIC TRIM

The boat may be equipped with optional automatic trim for the drive units or trim tabs. These controls are manufacturer-specific and communicate boat speed or engine RPM to the drives or tabs and provide hands-free adjustment under typical operating conditions. Most systems can be switched off for manual control at any time. Refer to the propulsion or trim tab manufacturer owner's manual for more information.

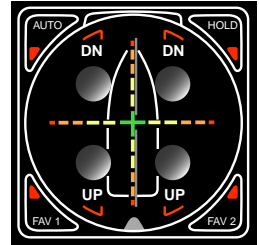

KC-6001

## DIGITAL SWITCHES

The boat may be equipped with a digital switching system that supplements standard AC and DC distribution switch panels. These systems can integrate digital switch touch-panels located in various spaces with Wi-Fi and/or Bluetooth apps via the NMEA 2K network in the boat for control and monitoring of various electrical and propulsion systems. A variety of modules plug into the network, eliminating the need for individual component wiring and control of complex onboard systems. Some systems can bring digital switching, power electronics and marine navigation systems together into one interactive, seamless system. Most systems are capable of many advanced features; read the manufacturer's user information for complete system operation.

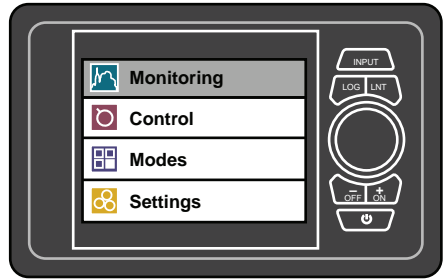

KC-6005

## TYPICAL DIGITAL SWITCHING CONTROLS

Most systems can be pre-programmed for boat support and can include setups for docking, cruising, lighting and more. Pre-programming ensures that all systems required for a support function are enabled for each particular mode. Modes can be customized if needed by the dealer.

**Control** – Used for individual control of circuit groups and components such as cabin lighting and forward lights, without the need to use the DC master panel and component switch.

**Monitoring** – Used to view status of various groups and systems such as DC control and house batteries, to show capacity remaining and state of charge. Alarms can be programmed to alert the skipper of low levels or capacity.



**Manual Circuit Bypass** – Most modules are equipped with a bypass setting for temporary manual operation via the DC master panel.

Interface modules are available for the following systems; some modules are optional and may not be available on the boat.

- Wi-Fi wireless for remote systems control and monitoring via mobile apps
- Tank level for fuel, water and waste tanks
- Signal input and output modules
- AC systems
- DC systems
- Switches
- Motors
- Connector modules for network, LAN, MasterBus and other NMEA 2K components

## NOTICE

*Customizing the software, updating the device firmware, setting alarms and adding components must be performed by a knowledgeable dealer technician. Boaters should not attempt changes unless they have the skills and knowledge to do so.*

## REMOTE OPERATION

The boat may be equipped with optional remote operation abilities for digital switches. Certain boat functions, such as lighting, air conditioning and other functions, can be controlled using an app on the boater's mobile device. The app communicates with the boat via a Wi-Fi or Bluetooth connection and requires close proximity to the boat.

Operation of the app and Wi-Fi setup can vary by type; read the Wi-Fi operation information and model-specific user's manual for proper use.





## NMEA 2K NETWORK

The boat may be equipped with an optional NMEA 2K network for digital communication between devices. Certified NMEA 2K devices can easily exchange data through the network without the need for additional sensors and wiring. Boaters who would like to add additional components using the network must contact a certified marine electronics installer. This professional installer has the knowledge and the tools necessary for proper installation.

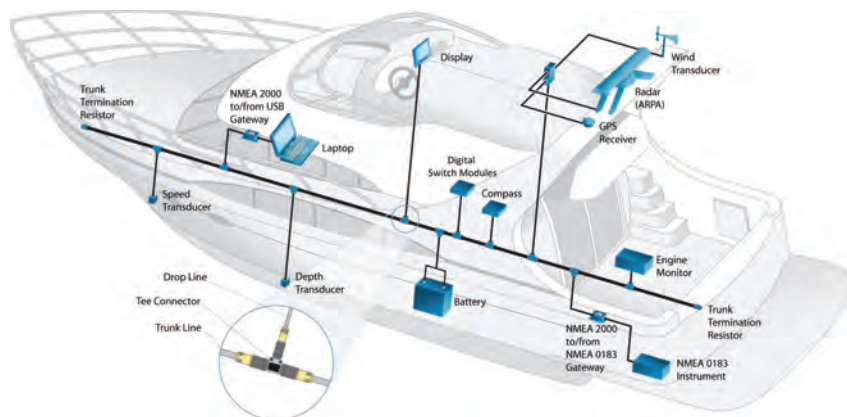

KC-6015

## GAUGES / INSTRUMENTS

The following basic and typical information may not apply to your specific boat. This section may not cover all gauges on the boat. See the *Engine Operator's Manual* or equipment manufacturer's supplied information on the use and operation of the unique gauges and instruments.

Gauges are visual indicators that help you monitor various system and component operation parameters. Gauges usually have lights integrated into them for visual clarity when operating at night. They are located near the helm area or other main control areas.



## MULTI-GAUGES

The boat may be equipped with one or more multi-gauges that combine an analog look with digital display of specific data such as fuel management/economy, trip logs and GPS and is speed-selectable with the touch of a button. Some multi-gauges allow boaters to customize the type of information and how it is displayed. These gauges communicate digitally over an NMEA 2K or CANBUS network and replace mechanical gauges, sensors and wires. Most units support multiple propulsion units and share data with other operation stations. Refer to the *Gauge and Propulsion Manufacturer's Owner's Manual* for more information.

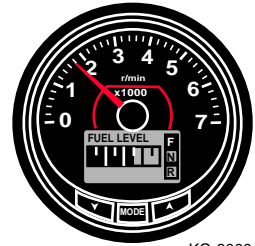

KC-6000

## TACHOMETER

The tachometer indicates engine speed in revolutions per minute (rpm). Monitor engine rpm at all times to keep the engine within the proper rpm operating range. See the *Engine Operator's Manual* for the rpm operating range of your engine.

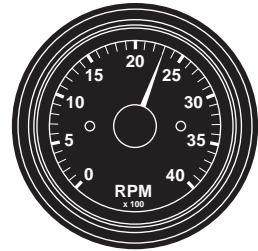

KC-0095-A

## SPEEDOMETER

The speedometer indicates approximate forward boat speed in miles per hour (mph).

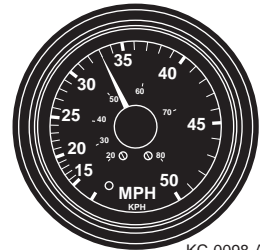

KC-0098-A



## FUEL LEVEL GAUGE

The fuel level gauge indicates approximate fuel level in the fuel tank. The accuracy of the fuel gauge may vary as the attitude of the boat changes; the reading is only an approximation. As a general rule, always use the “one third” rule. Use one third of the fuel to reach your destination, one third to return and one third as reserve fuel.

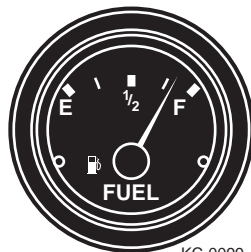

KC-0099-A

## ENGINE WATER PRESSURE GAUGE

The engine water pressure gauge indicates the water pressure of the engine cooling system in pounds per square inch (psi). This gauge monitors the engine cooling system operation and indicates overheating problems. See the *Engine Operator's Manual* for the normal operating range.



KC-0100-A

## POWER TRIM / TILT GAUGE

The power trim/tilt gauge indicates the angular position of the lower drive unit and propeller in relation to the transom of the boat.

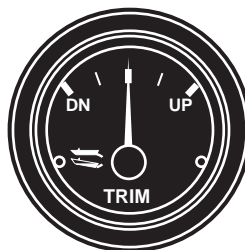

KC-0101-A



## VOLTMETER

The voltmeter indicates the voltage of the main cranking battery in volts DC. See the *Engine Operator's Manual* for the normal operating range.

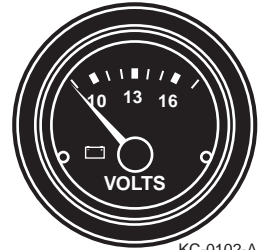

KC-0102-A

## AMMETER

The ammeter indicates the engine charging system current output to the electrical system. See the *Engine Operator's Manual* for the normal operating range.

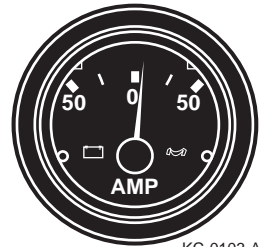

KC-0103-A

## ENGINE WATER TEMPERATURE GAUGE

The engine water temperature gauge indicates the water/coolant temperature of the engine cooling system. Most marine engines use seawater to cool the engine. A sudden increase in temperature could be an indication of a blocked cooling passage or a water pump malfunction.

Check the gauge immediately after starting the engine. If the temperature gauge is high, STOP the engine immediately and see the *Engine Operator's Manual* for corrective action.

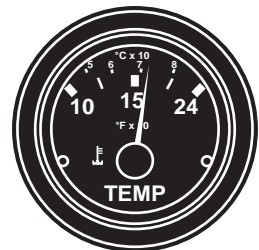

KC-0104-A



## ENGINE OIL PRESSURE GAUGE

The engine oil pressure gauge is used on 4-stroke engines to indicate the oil pressure of the engine. A drop in oil pressure could indicate a problem with the engine's lubrication system.

**CAUTION** *Stop the engine immediately if a complete loss of oil pressure occurs. Continual operation of the engine during a complete loss of oil pressure will damage the engine.*

See the *Engine Operator's Manual* for the normal operating range.

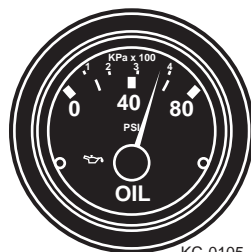

KC-0105-A

## ENGINE SYNCHRONIZATION GAUGE (DUAL ENGINE APPLICATIONS)

On twin-engine boats, an engine synchronization gauge can be used to synchronize the engine speed (rpm). This gauge allows the operator to adjust each engine throttle to operate at the same rpm to optimize boat performance. See the manufacturer's information for operating instructions.

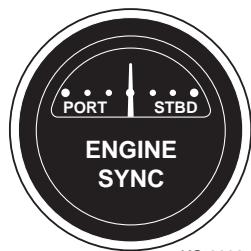

KC-0096-A

## ENGINE HOUR METER

The engine hour meter indicates the total number of hours the ignition switch is in the ON position. Under normal conditions, the engine is running when the ignition switch is ON; therefore, the hour meter provides an approximate indication of engine hours. An hour meter is useful in determining scheduled maintenance.

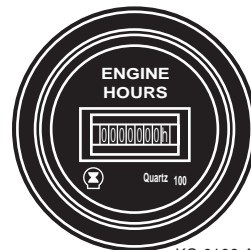

KC-0106-A



## WATER DEPTH GAUGE

The water depth gauge indicates the approximate distance between the bottom of the boat and the earth's surface directly below the transducer. To avoid running aground in shallow water, always add extra distance to meter readings. See the manufacturer's instructions for installation requirements and operating instructions.

## COMPASS

A compass assists in navigation by indicating where approximate north is located. See the manufacturer's instructions for operating instructions.

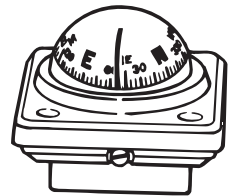

KC-0107-A

## ENGINE WARNING ALARM SYSTEM

The engine may have integrated audible alarms to warn of engine overheating, low oil pressure or other conditions. See the *Engine Operator's Manual* for more information.

## GASOLINE FUME DETECTOR INDICATOR

The gasoline fume detector is a safety device designed to sound an audible alarm when gasoline fumes are detected in the engine compartment or bilge area. The sensor for the detector is usually mounted in the bilge area where fumes collect. Test the detector before operating your boat every time to ensure it is working properly. Always turn on the bilge blower to evacuate fumes before starting the engine. See the manufacturer's instructions for installation requirements and operating instructions.

If the gasoline fume detector indicates a dangerous condition:

- Turn on the bilge blower.
- Do not operate electrical equipment.
- Extinguish open flames and smoking materials immediately.
- Turn off the engine.
- Wait five minutes before opening the engine compartment to investigate the cause.
- Correct the problem immediately before resuming operation.



## SMOKE DETECTOR

A smoke detector is a safety device designed to sound an audible alarm when smoke is detected in the area of the detector. Smoke detectors are recommended in areas where fire is a possibility, especially in boats that have confined areas such as sleeping quarters, galleys and head compartments. Regularly check the condition of the detector for proper operation. See the manufacturer's instructions for installation requirements and operating instructions.

## HELM AND CONTROL SWITCHES

The following information is intended as basic and typical and may not apply to your specific application. Not all switches may be covered in this section. See the *Manufacturer's Operator's Manual* for specific information on the use and operation of switches in the boat.

Many of the electrical features and systems in the boat are equipped with a control switch and protected with breakers or fuses. Switches are designed for different applications and found in many styles and shapes. Some switches may have a lighted indicator for easy ON/OFF identification. Some switch panels contain a master power switch that controls power to all circuits.

## IGNITION SWITCH

The ignition switch controls the engine starter circuit, the engine ignition system and accessory circuits connected to the ignition switch.

## BLOWER SWITCH

The blower switch is used on boats that use an engine within an engine compartment, such as sterndrive and inboard engines. The switch controls power ON/OFF to the engine compartment ventilation blower to remove explosive fumes from the engine and bilge areas.

You must operate the blower for a minimum of four minutes before each time the engine is started.



**WARNING** *Fire/Explosion Hazard: If equipped with a bilge blower switch, always operate the bilge blower for a minimum of 4 minutes prior to starting the engine. Gasoline vapors can explode, resulting in injury or death.*



## BATTERY SWITCH

Battery switches are used to control battery power distribution and disconnect the batteries from the boat's electrical system. Battery switches are designed in many styles and for different applications. They generally provide battery isolation when used with multiple batteries and are used primarily as a method of quick and positive battery disconnection. Battery switches also protect against tampering, electrical fire hazards and battery drain. Keep this switch off when not using the boat or when storing it for extended periods of time.

### NOTICE

*Do not turn off the battery switch with the engine running; this could damage the engine's charging system.*

Consult a qualified, knowledgeable technician for proper operation of the boat's specific electrical system.

ONE BATTERY

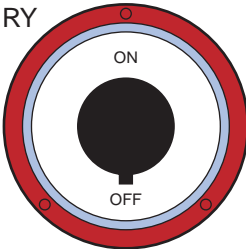

TWO BATTERIES

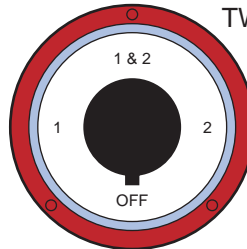

TYPICAL BATTERY SWITCHES

KCB-0006

**OFF Position** - Neither of the batteries are connected to the engine's starting or charging systems. The switch should be in the OFF position when the boat is not being used to ensure that the batteries do not lose their charge. The switch should also be in the OFF position when an external battery charger is being used to charge the battery(s) to avoid possible damage to the electronic components on the engine or in the boat.

### NOTICE

*Do not turn the battery switch to any other position with the engine running; this could damage the engine's charging system.*

**"1" Position** - This is usually the main battery. Normally when the battery switch is not OFF, it should be set on 1.

**"2" Position** - This is usually the auxiliary, house or backup battery. This position should only be used if battery 1 has become depleted and the reserve battery is needed to start the engine.



**“1+2” Position** - The switch may also be labeled “both” or “combined.” This position would be used in an emergency situation where both batteries are low and power is needed from both batteries to start the engine. Once the engine has started, carefully select battery 1 or battery 2 (but not OFF) to direct all of the charging current to one battery.

### NOTICE

*If the battery is dead or severely undercharged, do not use the engine charging system’s alternator to bring the battery to a fully charged condition. The excessive current draw can overheat the alternator and cause it to fail. If you have a dead battery, use an external battery charger to bring the battery to a fully charged condition.*

## ENGINE EMERGENCY STOP SWITCH AND LANYARD

The engine emergency stop switch controls the engine ignition ON/OFF. This safety device shuts the engine off immediately and prevents the boat from becoming a runaway if the operator is accidentally thrown from the seat or away from the helm.

Whenever the boat’s engine is on, physically secure one end of the emergency engine stop switch lanyard to the emergency stop switch and the other to the boat operator. If the operator is thrown from the seat or moves too far from the helm, the lanyard will disconnect from the switch, activating the switch to turn off the engine.

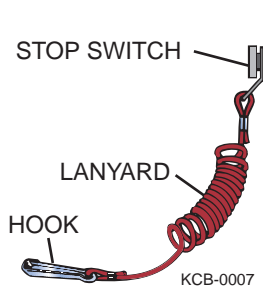

### WARNING

**Control Hazard: Never remove or modify the engine emergency stop switch and/or lanyard.**

- **Always check the switch for proper operation. With the engine running, pull the lanyard. If the engine does not stop, have the switch repaired before continuing to operate the boat. Never operate the boat if the engine emergency stop switch does not work.**
- **Attach the engine stop switch cord lanyard to a secure place on your clothing, your arm or leg while operating.**
- **Avoid accidentally pulling the cord lanyard during normal operation. Loss of engine power means loss of most steering control. Also, without engine power, the boat could slow rapidly. This could cause people and objects in the boat to be thrown forward.**
- **DO NOT attach the cord lanyard to clothing that could tear loose. DO NOT route the cord lanyard where it could become entangled, preventing it from functioning.**



## NEUTRAL START SAFETY SWITCH (START-IN-GEAR PREVENTION)

The neutral start safety switch provides start-in-gear prevention. The switch controls power to the engine starter circuit of the ignition switch. The engine gear shift control lever must be in the NEUTRAL position to allow the ignition switch to activate the engine starter. This safety device will prevent the boat's engine from starting if the engine is in gear.

## HORN SWITCH

The horn switch controls power ON/OFF to sound the horn.

## BLOWER SWITCH

The blower switch is used on boats that use an engine within an engine compartment, such as stern drive and inboard engines. The switch controls power ON/OFF to the engine compartment ventilation blower to remove explosive fumes from the engine and bilge areas.

## BOARDING AND COURTESY LIGHT SWITCHES

The boarding and courtesy switches control power ON/OFF to boarding lights and cockpit courtesy lights.

## POWER TRIM / TILT SWITCH

The power trim/tilt switch controls power ON/OFF to the engine's power trim/tilt electric hydraulic pump. This switch is usually a three-position switch, with OFF in the center. If engine is equipped with power trim and tilt, this system allows you to raise and lower the lower drive unit and propeller to adjust trim (the planing, and running angle of the boat while underway).

The tilt feature positions the lower drive unit up beyond the power trim range and is used for trailering, launching or beaching. Never use power tilt when the engine is running.

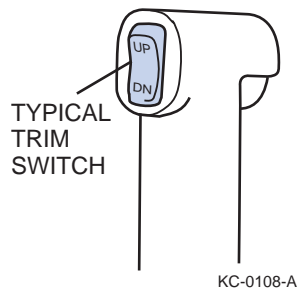



## TRIM TAB SWITCH

The trim tab switches control power ON/OFF to the boat trim tabs' electric hydraulic pump. This switch is usually a three-position switch, with OFF in the center. Each trim tab has a separate switch. Both switches can be used independently or simultaneously. Trim tabs adjust the boat's trim angle and help compensate for uneven weight distribution, listing, water conditions and other factors that contribute to planing inefficiency.

TYPICAL TRIM TAB SWITCH

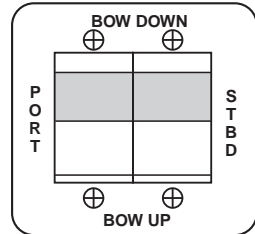

KC-0109-A

## FUEL GAUGE SWITCH

The fuel gauge controls power ON/OFF to the fuel gauge to allow use of the fuel gauge when the ignition switch is off.

## WINDSHIELD WIPER SWITCH

The windshield wiper switch controls power ON/OFF to the windshield wipers.

## NAVIGATION LIGHTS SWITCH

The navigation lights switch controls power ON/OFF to the boat's navigation, running and anchor lights. This switch is usually a three-position switch, with OFF in the center. When the switch is in the NAV position, the red and green navigational, white stern and running lights, and console gauge lights are activated. When the switch is in the ANC position, only the white stern light is activated.

Never operate the boat between sunset and sunrise using only the stern light. Use all navigational lights when operating underway between sunset and sunrise.

## BILGE PUMP SWITCH

The bilge pump switch controls power ON/OFF to the bilge pump to remove excess water from the bilge area of the boat. Some models are equipped with an automatic bilge pump setting. Switching to AUTO when the boat is in operation will allow water to be automatically pumped out when it reaches a level that activates the float switch in the bilge area.

**NOTICE**

*Be sure to switch the bilge to OFF (not AUTO) when your boat is not in use. Wave action or trailer travel can cause the pump to drain the battery. Running the pump when the bilge is dry will damage the pump. Do not allow the bilge pump to operate after all the water has been cleared from the bilge area; damage to the pump will occur if the pump is allowed to operate without water.*

If oil is spilled in the bilge, do not run the pump. Keep the oil from spreading in the bilge and properly dispose of the oil on shore.

**BILGE PUMP SYSTEM**

The Federal Water Pollution Control Act prohibits the discharge of oil or oily waste into the water. Violators can be fined \$5,000.

Water will enter a boat for a number of reasons, including heavy seas, strong storms and long periods of rain. The bilge area is usually the deepest part of the hull and where the water settles. The bilge pump moves water from the bilge area through hoses and empties it through an opening in the hull.

The bilge pump can be operated manually by a switch. Some models feature an automatic bilge pump setting. Switching to AUTO when operating the boat will allow water to be automatically pumped out when it reaches a level that activates the float switch in the bilge area.

**NOTICE**

*Be sure to switch the bilge to OFF (not AUTO) when you are not using the boat. Wave action or trailer travel can cause the pump to drain the battery. DO NOT allow the bilge pump to operate after all the water has been cleared from the bilge area; damage to the pump will occur if you operate it without water.*

**BOAT VENTILATION SYSTEM**

Boat ventilation systems allow the circulation of fresh air through compartments and enclosed areas of boats. The most common types of ventilation devices are manual or power-actuated vents, hatches, ports and windows that open and close. Ventilation ports are always located in head and galley compartments and are commonly found in cabins and sleeping areas.

Ventilation or blower systems are designed to remove explosive vapors that accumulate in the bilge area and engine compartment. Proper ventilation is extremely important to personal safety while boating.



Powered ventilation systems consist of one or more sealed fans that replace vapors with fresh air through intake and exhaust vents. Always operate the blower for at least 4 minutes before you start the engine. Operate the blower continuously when at idle and during slow-speed operation.

Natural ventilation systems also have intake and exhaust vents; as the boat moves, air is forced into the intake vent and escapes through the exhaust vents.

## AUTOMATIC FIRE EXTINGUISHING SYSTEM

Automatic fire extinguishing systems are self-contained systems that are designed to automatically activate to help extinguish fires. These systems include the extinguishing material, lines, nozzles, valves, sensors, controls and indicators.

In the event of an extinguisher discharge, immediately shut down all electrical and mechanical systems and powered ventilation. Automatic fire extinguishing systems are added protection to your safety and the boat's fire protection, but do not eliminate the need for hand held U.S. Coast Guard approved fire extinguishers. See the *Automatic Fire Extinguishing Systems Operator's Manual* for specific operation and service information.



### WARNING

***Fire Hazard: If the fire system discharges, wait for at least 15 minutes before opening engine hatch. Fire system gas displaces oxygen to "smother" the fire. Opening the hatch too soon may feed oxygen to the fire and flashback can occur.***

## FRESHWATER SYSTEM

A freshwater system provides potable (drinkable) water to sinks, showers, water heaters, ice makers and/or cockpit washdowns. Common freshwater systems are either manual or pressurized. Manual systems consist of a storage tank and hand pump/faucet. Pressurized systems may include a storage tank, electric pump, faucet, filter, accumulator, city water hookup connector, water heater, and showers, sinks or other appliances that require potable water. Regardless of the type of system, all freshwater drainage (gray water) is directed overboard and is usually untreated.

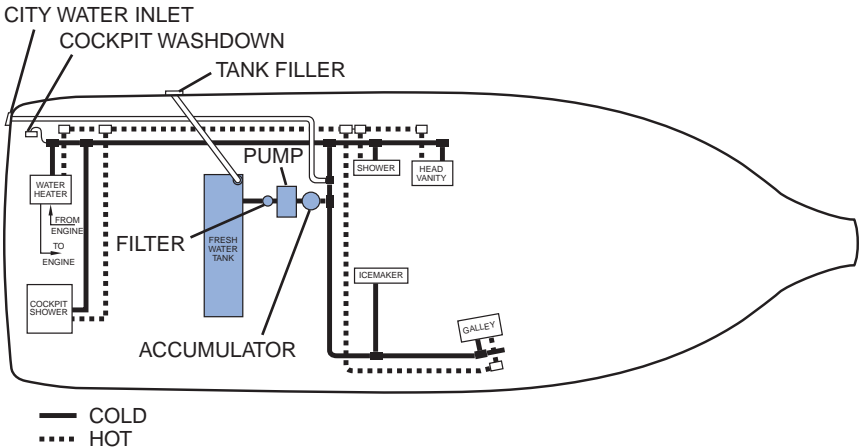

TYPICAL COMPLEX FRESHWATER SYSTEM

KC-0172-A

### Filter, Pump and Pressure Accumulator

Water flows from the tank through a filter to strain out any contaminants, and then flows to the pump. The pump provides a flow of water at a preset system pressure. Some pumps include a safety feature that will shut the pump off if it runs dry or when the tank is emptied. A pressure accumulator-style tank provides a smooth flow of water by maintaining a constant pressure in the lines to the various freshwater appliances.

#### Operation Guidelines:

- Fill the freshwater tank with potable water.
- Close all faucets and drains.
- Turn on the freshwater pump circuit breaker.
- Open each cold and hot water faucet to allow air to escape. Close the faucets when a steady flow of clean water is apparent.
- After all lines are empty, the pump will build to operating pressure and shut off.
- Refill the freshwater tank with potable water.



## Freshwater Tank

Freshwater tanks are usually filled through a deck plate filler marked “WATER.” A hull vent allows air to enter and escape the tank as the water level rises and falls. The tank is full when water comes out of the vent.

Fill the tank with only potable (drinking) water. The tank will continue to provide clean drinking water if you use and refill it often.

TYPICAL DECK PLATE KEY

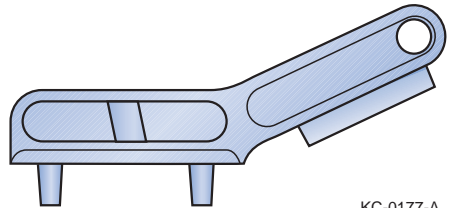

KC-0177-A

Guidelines when filling the tank:

- Remove the “WATER” filler cap with the key provided with your boat. Turn counterclockwise to remove the cap.
- Always use a sanitary drinking water hose (blue) when filling the tank with fresh drinking water.
- Replace the cap and fasten securely with the key.

## City Water Hookup

When docked, you can connect the boat’s freshwater system to a city water system or shore pressurized system as an alternative to the on-board freshwater tank system.

Pressurized shore systems bypass the boat’s freshwater tank and pump system, and connect directly into appliance lines. A pressure regulator limits the maximum pressure supplied to the system.

### **NOTICE**

*Always monitor the boat’s water system during initial usage of the city water feature. In this mode, the boat is connected to an unlimited source of water. DO NOT leave the boat unattended while using city water. Any major leak or break in the system could cause sinking or swamping of the boat.*

Using the city water hookup does not replenish water supply in the tank. You can only fill the tank at the freshwater fill plate. Before connecting to any water fitting (dockside or otherwise), be sure the water is potable and suitable for human consumption. Also, a special sanitary drinking water hose is required for the potable water connection. Never use a common garden hose for drinking water.



Guidelines when connecting to city water:

- Turn off the freshwater pump breaker.
- Remove the threaded plug from the female swivel hose connector of the city water inlet fitting. Clean the strainer.
- Only connect a sanitary drinking water hose to the water inlet fitting.
- Be sure to clean both ends and flush the hose before connecting. Foreign matter may damage the pressure regulator.
- Before connecting to the dockside city water outlet, open the valve fully to flush any rust particles that may be present.
- Connect the hose to the dockside city water outlet.

### Hot Water Heater

Most water heaters are electrically heated and are equipped with a high-pressure relief valve and thermostat for safety.

Guidelines when operating the water heater:

- Fill the freshwater system or connect to city water and bleed air from all lines.
- Turn on the water heater circuit breaker.

### NOTICE

*DO NOT turn on the water heater circuit breaker switch unless the freshwater system is charged and the water heater is filled. Damage to the heating element will result if it heats up with no water in the system. Some water heaters are equipped with a high-temperature limit switch to protect the heating elements if the heater is activated with no water in the tank. If the system does not operate for any reason, turn off the water heater breaker and push the reset button on the heater.*

### LIVEWELLS

Livewells are designed to help protect and keep fish or bait alive. Some are equipped with an aeration pump that circulates and refills the water in the livewell to help keep fish alive.

Always clean and empty the livewells after each use to prevent contaminating the fish. Never use soap, detergents or other cleaners that may be harmful to fish to clean the livewell.

If a livewell system does not drain completely, you may have to bail remaining water by hand or remove your boat from the water.



**NOTICE**

*To avoid freeze damage to the livewell system, be sure it is completely empty in freezing weather. Residual water in the system may freeze and cause damage.*

Livewell systems are usually manual, remote or recirculating. Do not use manual and remote livewell systems while your boat is in operation or on the trailer. Also, make sure the livewell pump is switched off, or pump damage will occur.

**RAW WATER SYSTEM**

Raw water is seawater (non-drinking water). Some boats use raw water systems for engine cooling, head, and utility and cockpit washdowns. Some raw water systems may supply two components and have a flow control valve for directing water flow.

Raw water systems include:

- An individual thru-hull raw water intake.
- A seacock and strainer. The seacock protects your boat from sinking if a downstream hose or fitting would fail. Always close any seacock not in use.
- A pump to draw water into the system. Engines may have belt- or pulley-driven pumps; heads may have manual push/pull or electric pumps, and utility and cockpit washdowns may have electric pumps.
- An outlet valve, fitting or nozzle.

Guidelines when operating a raw water system:

- Open the desired seacock.
- Adjust flow control valve (if equipped).
- Turn on appropriate pump switch as required.



# BOAT FEATURES AND OPTIONS

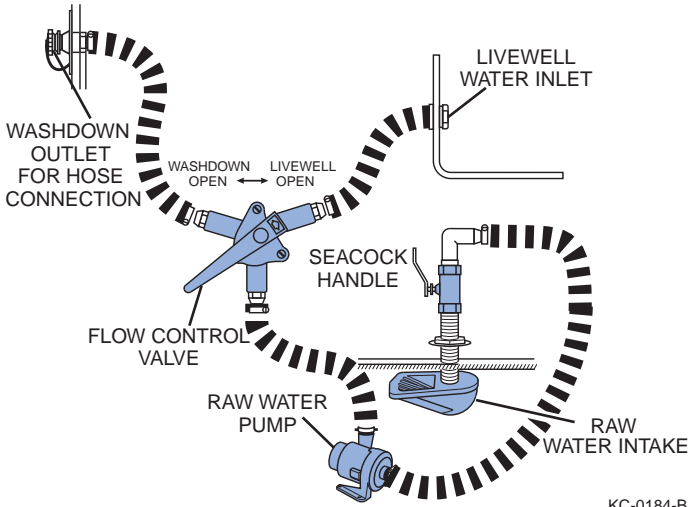



## HEAD AND WASTE CONTAINMENT SYSTEM

Always check state and local regulations before discharging waste overboard.

The boat may be equipped with an onboard Marine Sanitation Device (MSD). There are four types of MSD systems and the USCG regulations differ depending on the type used. All MSD systems consist of a toilet (head), a holding tank for waste containment/treatment, a pumpout fitting located on the deck, and all must be USCG-certified. Some systems include an overboard discharge that can only be used under specific conditions and beyond three nautical miles from the coast. The following guidelines are federal; check state and local regulations on usage.

MSD SYSTEM TYPE	CAN BE USED ON	DESIGN	NOTES
Portable Toilet	Any boat	All-in-one toilet and holding tank	Does not treat waste; must be emptied ashore
Type III	Any boat	Holding tank with pumpout. Most popular on recreational boats for inshore & inland use	May treat and/or process waste. Must be pumped out at wastewater treatment facility
Type II	Any boat; required on boats over 65 feet in length	Similar to Type I but uses additional treatment. Typically found on commercial boats for offshore use	Adds biological or aerobic digestion for waste discharge overboard
Type I	Boats under 65 feet in length	Flow-through discharge using chlorination and maceration	After treatment, waste can be discharged overboard when at least three nautical miles from shore



### MSD Operation Considerations

- **No Discharge Zone (NDZ):** A designated body of water that prohibits the discharge of treated and untreated boat sewage regardless of the distance from shore. The Great Lakes and most inland lakes are designated NDZs. Boaters who have a Type II or III MSD must secure the MSD from accidental overboard discharge in accordance with local laws. For info on NDZs by state, go to [www.epa.gov/vessels-marinas-and-ports/no-discharge-zones-ndzs-state](http://www.epa.gov/vessels-marinas-and-ports/no-discharge-zones-ndzs-state)
- **Waste Management Plan (WMP):** Although a WMP is designed for solid waste, it is a good idea to add a section in your waste management plan covering the MSD. See Waste Management Plan (WMP) in this section for more information.

Discharging untreated waste overboard is harmful to swimmers and those who eat the local fish and shellfish. Boaters must do their part to maintain the otherwise pristine waters regularly used by snorkelers and swimmers. Use the holding tank offshore whenever possible and empty at a marina pumpout station. Boaters who do not know how to use the facilities should ask the marina master. Leave a clean wake.

Head (marine toilet) and waste containment systems are available as manual or electrically-operated systems. Electrically operated systems use electric raw water pumps to flush waste from the marine toilet into the boat's waste tank. A waste tank indicator may be installed to provide a visual indication of the amount of waste in the tank.



**KEEP OUR  
WATER CLEAN—  
USE PUMPOUTS**

KCB-0066

### **NOTICE**

*Do not place facial tissue, paper towels or sanitary napkins in the head. Such material can damage the waste disposal system and the environment.*

All boats with heads are required to have a USCG-approved operable marine sanitation device installed. These devices, commonly called macerators or chlorinators, are used to break up solid and chemically treated waste and discharge it into waste tanks or overboard.

### Waste Removal System Types

- **Dockside Discharge** - Waste tanks are emptied through a deck plate fitting marked "WASTE" by special waste removal equipment on the shore.
- **Overboard Discharge** - Waste tanks are emptied through the hull into the sea/lake. A "Y" valve is used to change discharge flow between the marine toilet and the waste holding tank.



Components of waste systems are constructed of materials specially formulated to prevent odor permeation and resist chemical actions. Regularly add approved waste treatment chemicals to your tank by flushing them through the head. The chemicals help to control odor and break down the waste. Follow chemical manufacturer's instructions before use.

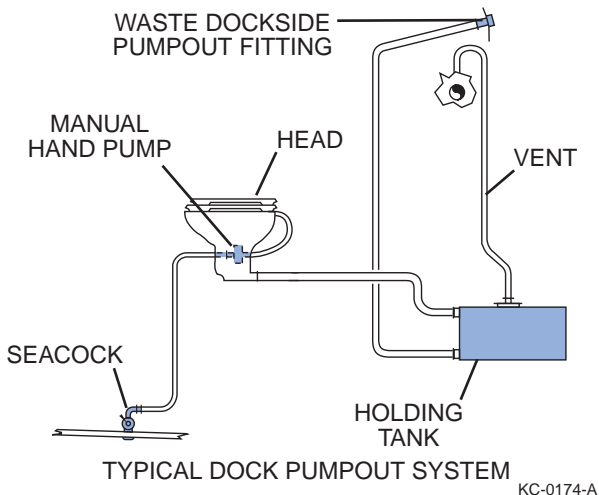

### Marine Head Operation

See the marine head manufacturer's information for specific information.

#### **NOTICE**

*DO NOT flush the head when the holding tank is full. Attempting to flush the head when the waste tank is full could result in damage to the waste system.*

### Guidelines for Electrically Operated Marine Heads:

- Open the raw water seacock to the head.
- If you are using overboard discharge, make sure the "Y" valve is in the overboard position and that the macerator discharge seacock is open.
- To charge the head, press the foot pedal on the lower left side of the bowl and push the flush button. Release the flush button after the bowl is moistened. Then pump the floor pedal two to four times to fill the bowl with water.



## BOAT FEATURES AND OPTIONS

- To flush, press the foot pedal and push the flush button at the same time. Hold until all waste is removed.
- To empty the bowl of excess water, operate the flush button until water decreases to the desired level.

### Guidelines for Manually Operated Marine Heads:

- Open the inlet water seacock below the cabin floor.
- If you are using overboard discharge, make sure the “Y” valve is in the overboard position and that the macerator discharge seacock is open.
- Pump the floor pedal two to four times to fill the bowl with water.
- To flush, press the foot pedal and operate the flush handle next to the head at the same time. Operate the handle until all waste is removed.
- To empty the bowl of excess water, operate the flush button until water decreases to the desired level.

## FUEL-BURNING APPLIANCES

** DANGER** *Exhaust Hazard! Fuel-burning open-flame appliances consume cabin oxygen and release products of combustion into the boat. Ventilation is required when appliances are in use. Open designated vent openings while appliances are in use. Never obstruct ventilation openings and ensure that flued appliances are operating correctly.*

Be sure to read and understand the *Appliance's Owner's Manual* information and follow the appliance's safety labels before operating the appliance. Fuel-burning or open-flame appliances consume cabin oxygen and release products of combustion in the craft. Ventilation is required when operating or changing fuel cylinders for these types of appliances. Make sure there is adequate ventilation and the appliance is working correctly. DO NOT use these types of appliances to heat the galley or cabin spaces.



## LIQUEFIED PETROLEUM GAS (LPG) APPLIANCES



### WARNING

*Fire/Explosion Hazard:*

- **Never leave craft unattended when open flame LPG-consuming appliances are in use.**
- **Do not smoke or use open flame when replacing LPG cylinders. Close cylinder valves on empty cylinders before disconnecting for replacement.**
- **Never use a flame to check for leaks.**
- **Fuel-burning open flame appliances consume cabin oxygen and release products of combustion into the boat:**
  - **DO NOT use the stove or oven for space heating.**
  - **Open designated vent and openings while appliances are in use.**
  - **Never obstruct ventilation openings.**
- **Do not modify the craft's LPG system. Installation, alterations and maintenance shall be performed by a competent person. Have the system inspected at regular intervals or as required by national requirements.**
- **If a leak is detected shut off the main LPG supply valve and do not use LPG appliances.**

### NOTICE

*Use only a liquid soap and water solution for manual leak testing. Do not use solutions containing ammonia which will deteriorate brass fittings.*

If your boat is equipped with an LPG system:

- The use of LPG produces carbon monoxide gas. Be sure spaces containing LPG appliances are well-ventilated.
- Do not obstruct access to the LPG appliance in any way.
- At least annually, inspect the hose and vent of the appliance. Replace if any deterioration is found.
- Valves on empty cylinders must be kept closed and disconnected. Protective covers, caps or plugs must be kept in place. Reserve or empty cylinders must be stored in LPG cylinder lockers or housings which are vented to the outside and intended for that purpose or on the boat exterior, protected from the weather and mechanical damage, and where escaping vapors can only flow overboard.
- LPG cylinder housings or cylinder lockers must not be used for storage of any other equipment.



### General Operation of an LPG Appliance

**IMPORTANT** Refer to the *Appliance's Owner's Manual* for specific operation.

LPG supply line valves and cylinder valves must be closed when appliances are not in use, before refueling and immediately in an emergency.

Appliance valves must be closed before opening cylinder valve.

Open designated vent and openings while appliances are in use.

Never obstruct ventilation openings.

If the stove is not gimballed, it shall not be used when high angles of rolling or sustained angles of heel are likely.

** WARNING** *Fire/Explosion Hazard: Do not use an LPG installation that has leaked until it has been inspected and repaired by a competent person.*

If LPG leakage is detected or suspected, the following action must be taken immediately:































- Shut off the LPG supply at the main supply valve(s).
- Extinguish naked flames and other ignition sources (heaters, cooking appliances, pilot lights, etc.).
- Do not operate electric switches.
- Evacuate the area if possible.



## BOAT FEATURES AND OPTIONS



## SYMBOLS

BASE SYMBOLS				
				
Boat	Boat Profile	Engine	Tank	Light
SWITCH SYMBOLS				
				
Interior Light	Anchor Light	Navigation Light	Engine Room Blower	Bilge Pump
				
Windlass	Depth Finder	Windshield Wiper	Windshield Washer	Horn
ENGINE SYMBOLS				
				
Ignition	Hour Meter	Engine Key	Engine Stop	Engine Alert
TANK & BATTERY SYMBOLS				
				
Fuel	Waste Holding	Freshwater	Battery	Battery Parallel
OTHER SYMBOLS				
				
Sling Point	Lift Point	Fuel	Diesel Fuel	Safety Alert



SECTION

9

## BOAT FEATURES AND OPTIONS

This Page Intentionally Left Blank

# Section 10

## GENERAL CARE AND MAINTENANCE

The boat may feature a variety of specialized systems and components. The following basic and typical information may not apply to your specific application. This section may not cover all systems or components on the boat. See the *Engine Operator's Manual* or the equipment manufacturer's information for maintenance procedures.

Maintenance procedures may require special knowledge and equipment. Always consult the boat dealer for assistance in performing service, maintenance or modifications to the boat.

Neglect of maintenance and unauthorized service work is not recommended and may void your warranty. Refer to the *Engine and Equipment Manufacturer's* maintenance schedules and requirements, and keep a detailed log of the procedures and dates completed. Always consult the boat dealer for assistance with periodic maintenance.

Before performing any general care and maintenance procedures within this section, review *Safety in Section 2*.

### ENGINE

The manufacturer of the boat's engine(s) will provide a separate maintenance procedure. See the *Engine Operator's Manual* for specific information on maintenance procedures.

### FUEL SYSTEM

 **WARNING** *Fire/Explosion Hazard: Gasoline is extremely flammable and highly explosive under certain conditions.*

Be sure to check the fuel hoses and connectors for leaking and deterioration before fueling and on a monthly basis.

Fuel vents are normally located in the deck in the same general area as the fuel fills. Periodically check that the fuel fills and vent lines are free of obstructions and kinks.

Check and/or replace the fuel filter periodically or clean as needed. Check fuel lines, vent hoses and drain hoses frequently for leaks. Replace any worn or cracked hoses.



SECTION  
**10** GENERAL CARE AND MAINTENANCE

Tightening a fitting or clamp may correct a fuel leak. If the leak continues, however, replace the line, fitting or hose immediately to prevent a build-up of fluids or gases.

Use fuel system parts certified for marine use only. Never use automotive parts in marine applications.

## ELECTRICAL SYSTEM

Before performing any work on the electrical system or the battery, review *Safety in Section 2*.

## BATTERIES

 **WARNING** *Electrical Shock Hazard: Always disconnect the batteries before performing maintenance on the DC electrical system. Electrical shock may occur if the batteries are not disconnected during maintenance on the DC electrical system.*

 **WARNING** *Personal Injury Hazard: Always wear gloves and protective eyewear when working on and around the batteries. The batteries contain an acid called electrolyte. Avoid causing damage that could spill electrolyte into the bilge when servicing the batteries. Avoid getting salt water in or on the battery. Either condition can create a poisonous gas that is harmful if inhaled. Always disconnect the batteries before cleaning.*

 **CAUTION** *Personal Injury Hazard: Never allow a tool to bridge across the battery terminals. Injury can result if the terminals are accidentally bridged with a tool or other conductor.*

Today's boats can be loaded with electronics that all run off the boat's battery. Because of this, many boats will have two or more batteries: one for starting and running the engine, and one for electronics, commonly referred to as the house battery. One advantage is that the starting battery will not be drawn down when using electronics with the engine off, such as with a stereo. Another advantage is if the starting battery has lost capacity because of age, the battery switch has a 1+2 (Both) position that parallels both batteries for emergency starting. See the Blower Switch section of this manual for more information.

Marine batteries generally come in two types: starting and deep-cycle. Starting batteries are similar to car batteries, can supply lots of current for a short period of time and are used for starting the engine. Starting batteries should be recharged



almost immediately and do not tolerate deep discharges. Deep-cycle batteries are designed for repeated discharging and recharging cycles without damage. They are used as the house battery on boats with higher DC power requirements.

All batteries have one thing in common — they run for a while, need recharging and require an eventual replacement as the capacity fades. Most marine batteries are sealed and require no maintenance other than keeping them at a full state of charge and diligently cleaning corrosion from the terminals. To maintain long life, deep-cycle batteries should not be discharged more than 50% before they are recharged.

Most marine batteries are flooded, sealed lead-acid, but there are several different battery types/chemistries that could be used. You must use caution when charging or replacing the batteries; replace batteries with the exact same type, group and capacity. If your boat is not equipped with an onboard battery charger, use a smart charger suitable to your battery type/chemistry.

**⚠ CAUTION** *Burst Hazard: Never use an automotive type (lead-acid) battery charger to charge a gel cell type battery. Doing so will cause damage to both the charger and battery and can cause the battery to burst. Use a battery charger specifically designed to charge gel cell type batteries.*

Always turn off the battery switch (if equipped) or disconnect the negative battery cable before servicing the electrical system.

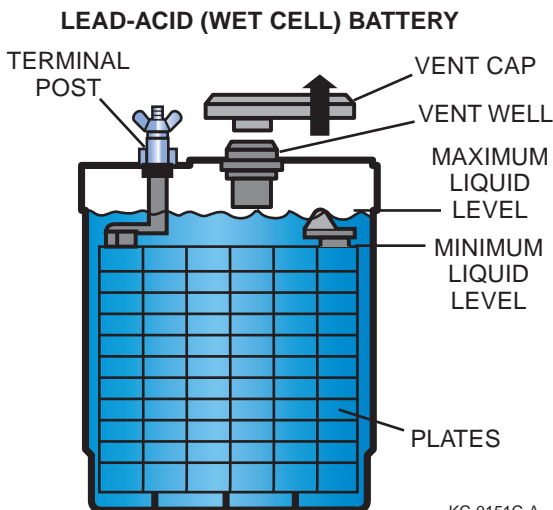



When you install a battery:

- Make sure the battery terminals are clean.
- Be certain to use correct polarity when you connect the battery cables to the battery.
- Make sure the cable connections are tight.
- Always shut down the engine before removing or attaching battery cables and never run the engine with the battery cables disconnected.
- Always remove the negative (-) cable first. Always attach the negative (-) cable last.

Check the battery frequently for signs of corrosion. If corrosion is evident, clean the terminal posts with a baking soda and water solution and a wire brush. Disconnect the battery terminals before cleaning.

**WARNING**

**Burn Hazard: Lead-acid battery fluid can cause severe burns.**

Check the fluid levels in the cells.

**NOTICE**

*Some batteries are sealed and cannot be filled. A level of approximately 1/4 to 1/2 in. (6 to 13 mm) above the plates is sufficient. If needed, fill with distilled water; do not overfill.*

During extended periods of non-use, batteries will self-discharge and should be recharged. Before recharging, disconnect the battery terminals and remove the battery from the boat. Recharge the battery according to the directions enclosed with the battery and battery charger. When installing the battery in the boat, make sure the battery is secured in the battery box, the terminals are tight and all protective covers are in place.

**WARNING**

**Fire/Explosion Hazard: Hydrogen gases produced by a lead-acid battery while it is charging, or the engine is running, can cause a fire and/or an explosion.**

## CIRCUIT BREAKERS AND FUSES

Never exceed the recommended fuse sizes or bypass a fuse in a circuit. Always install the proper (type and rating) fuses whenever replacing or changing fuses. Continuous fuse/breaker failures indicate a severe problem and require immediate attention.



**⚠ WARNING** *Fire Hazard: Never reset a circuit breaker that has been automatically tripped or replace a fuse that has blown without first identifying and correcting the cause of the problem. Failure to correct the cause may result in a fire hazard.*

TYPICAL BREAKER / FUSE PANEL



KC-0247C-A

Some applications use circuit breaker switches to provide individual circuit protection with the ability to manually reset the breaker switch.

To reset a tripped circuit breaker, move the breaker switch to OFF. Identify and correct any problems with the circuit and unplug all loads connected to it. Wait a minimum of one minute for the breaker switch to cool and then push the breaker switch to ON. Turn the breaker switch to OFF immediately if it trips, and consult qualified personnel.

To replace a fuse, locate the fuse block and the failed fuse. Carefully remove the fuse without touching other fuses or wires. When possible, use a fuse removal/installation tool. Some accessories have in-line fuses accessible inside the helm or near the battery.

**⚠ WARNING** *Fire Hazard: DO NOT exceed the recommended fuse sizes or bypass the fuse safeguard. Always install the proper (type and rating) fuses whenever replacing or changing fuses.*



SECTION  
**10** GENERAL CARE AND MAINTENANCE

**NOTICE**

*A boat's electrical system is designed to protect you from electrocution, short circuits and overloads. Have a qualified electrician perform any modifications to the system such as adding electrical accessories. Some installed accessories, such as stereos, have an additional fuse located in-line with the positive lead. Other accessories may use in-line fuses near the battery.*

## **GALVANIC CORROSION**

Galvanic corrosion (electrolysis) is the deterioration of metals from the effects of electrolytic action. When two dissimilar metals are immersed in a conductive fluid such as salt water, an electric current is produced, much like a battery. As current flows between the two metals, the softer, or sacrificial, metal deteriorates.

If you operate in salt, polluted or brackish waters, the boat should be equipped with a transom-mounted sacrificial anode to prevent corrosion damage to other metal parts of your boat that are in contact with the water. The anodes are self-sacrificing and are slowly eroded by electrolytic action. These anodes are important and require periodic inspection for deterioration. Replace the anode when it is less than 50% of its original size.

Most engines are equipped with one or more anodes that require periodic inspection. See the *Engine Operator's Manual* for maintenance procedures.

Electronic cathode systems are designed to reduce the effects of electrolysis. Electronic cathode systems emit an electrical low-current charge into the water near the metal components' neutralizing electrolytic action.

**NOTICE**

*Do not paint or coat sacrificial anodes or cathodes with any substance. Once covered, they do not provide protection from galvanic corrosion. Replace anodes if they have deteriorated 50% or more.*

## **SALTWATER CORROSION**

Rinse the boat hull and deck with fresh water and wash immediately after using the boat in salt water. If the boat is used primarily in salt water, wax the hull monthly and apply corrosion inhibitor to all hardware. See the *Engine Operator's Manual* for the flushing procedure.

Flushing the freshwater engine cooling system is recommended when the engine has been used in salt, polluted or brackish waters. Flush the entire engine cooling system with fresh water for at least 5 minutes after use in these waters. Consult the boat dealer for suitable flushing equipment.





## SACRIFICIAL ANODES

Anodes (sometimes called “zincs”) are used to protect hardware exposed to the water. Since galvanic corrosion attacks the least “noble” metals first, less noble metal anodes are used to purposefully “sacrifice” themselves, thereby protecting the more noble metals of the drives, propeller, tabs, boarding platform and other metal items below the waterline (such as underwater gear).

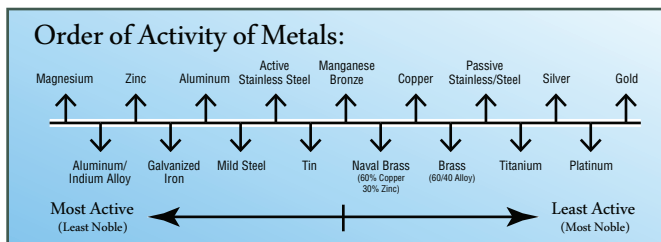

KC-6009

Anodes may be installed on the boat transom and/or bottom at the factory. Additional anodes may be installed on the underwater gear as well as any metal components exposed to raw water, such as heat exchangers and water cooling jackets. Anodes are made in three different metals which must be matched to the water type and local conditions. Most boats are equipped from the factory with zinc anodes on the recommendation from engine and drive manufacturers. The anodes that are installed on the trim tabs are typically zinc and are isolated from the boat bonding system.

Selection, monitoring and replacement of the anodes on the transom, drives, trim tabs, boarding platform supports and other underwater gear is the customer’s maintenance responsibility. Any damage done because of lack of maintenance will not be covered under warranty.

WATER TYPE	ANODE MATERIAL	REPLACE AT
Salt water	Zinc	40% decomposition
Brackish water	Aluminum	50% decomposition
Fresh water (clean)	Aluminum/magnesium alloy	50% decomposition
Fresh water (polluted)	Magnesium	40% decomposition

**NOTICE**

To be effective, anodes must be bare metal. If the boat is dry-docked more than 24 hours, sand the anodes to clean oxidation from the surface.

- Zinc and aluminum anodes left in fresh water or zinc anodes used in brackish water will become covered with white oxide which effectively stops the sacrificial process and exposes the underwater gear to damage.
- Do not paint sacrificial anodes. Bottom paints/sealants on anodes will block the sacrificial process and expose the underwater gear to damage.
- Depending on local conditions, some anodes can deteriorate very quickly and must be closely monitored. See the boat dealer for recommendations.

Because of the vital function that anodes play in the protection of underwater gear, replace anodes at the recommended level of decomposition, or annually, with the correct type. Boats stored in salt water will normally need to have the anodes replaced every 6 months to one year. Anodes requiring replacement more frequently may indicate a stray current problem within the boat or at the slip or marina.

Anodes that do not need to be replaced after one year may not be providing the proper protection. Loose or low-quality anodes could be the problem. There could also be a problem in the bonding system or the wrong anode material is being used.

The boater/customer has the responsibility in maintaining and ensuring that the proper anodes are installed for the area (water) in which the boat will be used. See the boat dealer about changing material or adding additional anodes.

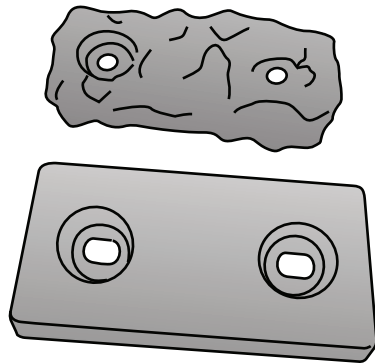

KC-6006

**STEERING SYSTEM**

Inspect and maintain the boat's steering system regularly. Frequently check the hardware at the helm, engine or rudder end for tightness. See the *Engine Operator's Manual* or the steering manufacturer's information for the appropriate torques.



TYPICAL HYDRAULIC STEERING SYSTEM

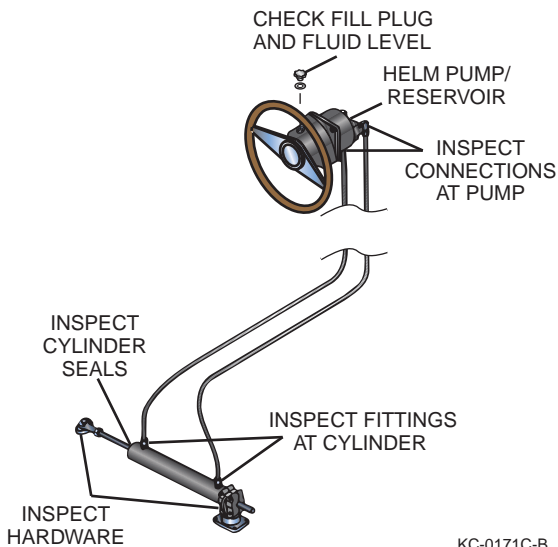

Make sure hydraulic hoses are tight and leak-free. Check cylinder seals for dampness, which indicates leaking. Check the fluid reservoir monthly and top off if necessary. See the steering system manufacturer's information for more details.

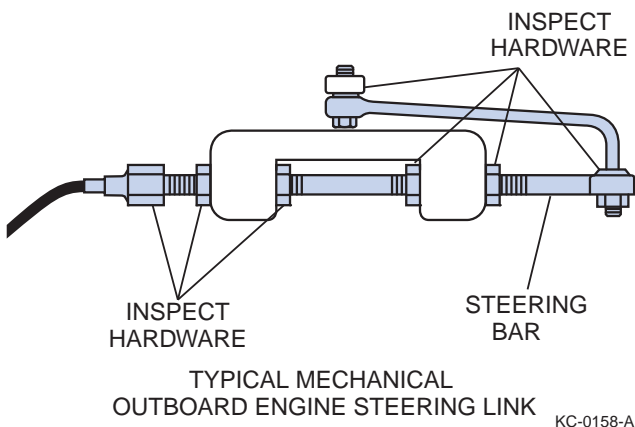

## **CORROSION PROTECTION**

### **HARDWARE, FASTENERS AND FITTINGS**

Check all fasteners, fittings, hinges, latches, rails and cleats for corrosion and tightness. Repair or replace any items that need attention. Never use automotive replacement parts when replacing marine parts.

Periodically clean all hardware with approved marine cleaners or mild soap and water. Never use abrasive cleaners or materials; they will scratch the polish and protective coatings on the hardware and cause the hardware to corrode. Applying a coating of marine-grade wax can help maintain the original shine of the hardware and help prevent corrosion.

### **STAINLESS STEEL AND CHROME HARDWARE**

Stainless steel and chrome will normally oxidize over time, especially in marine environments. Cleaning and preventive maintenance of stainless steel and chrome hardware are crucial in maintaining appearance and functionality. If the hardware is left unattended, it can corrode, causing the hardware to appear unsightly and cause structural integrity problems.

Wash the stainless steel and chrome hardware with mild soap and water after operating the boat in corrosive environments such as salt water.

Remove rust or corrosion promptly by cleaning the hardware using a high-quality stainless steel, chrome cleaner or conditioner. Do not use any abrasive materials such as steel wool or sandpaper to clean the hardware. Do not use acids or bleach or any cleaners not intended for stainless steel or chrome, such as glass, tile or counter cleaners, as these types of cleaners can cause permanent damage. Always test a cleaner in an inconspicuous area first before applying to the complete surface.

After cleaning, protect the surface of the hardware by using a high-quality boat, automotive, stainless steel or chrome protectant or wax.

### **ALUMINUM HARDWARE**

Periodically wash aluminum hardware with soap and water to keep it clean. If the boat is used in salt water or polluted water, wash aluminum hardware with soap and water after each use. Salt water allowed to remain on aluminum will penetrate the metal and corrode the aluminum.



It is recommended to frequently clean and coat all aluminum hardware with a metal protectant made for aluminum to protect against pitting and corrosion caused by the harsh effects of salt water. Choose an appropriate cleaner specific to your needs, as special cleaners are available for different types of aluminum hardware such as anodized, powder coated and polished.

Most stains can be removed from aluminum with a metal polish or fine polishing compound. To minimize corrosion, use a caulking compound or Teflon-based sealer to isolate hardware and fasteners mounted to aluminum fabrications. With proper care, aluminum hardware can provide many years of service.

## GENERAL MAINTENANCE AND CLEANING



### WARNING

***Asphyxiation Hazard: Do not mix cleaning agents together; toxic vapors may be released. Read and follow safety-related precautions found on the product labels.***

## MARINE GROWTH

If accelerated marine growth is a problem in your area, an antifouling bottom paint may be necessary to slow growth and prevent gelcoat damage. Before selecting a bottom paint, talk to the boat dealer to determine which product works best in your area. Many local variables can affect the selection of paint. Be sure to follow the paint manufacturer's directions exactly.

## CLEANING

Never allow any type of cleaning solution or cleaning material to come in contact with the water or be discharged into the water. The discharge of any type of debris or waste, including, but not limited to, food, trash, garbage, oil, fuel, liquids and human waste, is highly restricted, if not unlawful, in most waterways. Never discharge anything into the water.

Periodic cleaning is the best way to keep the boat looking new. Regular washing and waxing keep dirt, algae and water deposits from building up and deteriorating the finish. Keeping the boat in "show room" condition means greater personal satisfaction and higher resale value. Special cleaning products are available from the boat dealer.



## HULL

When washing the boat, use a mild detergent with a warm water solution. Never use any kind of alkaline cleaners such as Tri-Sodium Phosphate (TSP), abrasive cleaners, solvents, ammonia or chlorine to clean gelcoat surfaces, as these will damage the gelcoat surface. Special cleaners are available from the boat dealer to remove marine growth and algae from the hull.

Wax gelcoat surfaces at least twice a season. Special marine gelcoat waxes are available from the boat dealer to prevent color fade and dirt adhesion. If the gelcoat has oxidized, chalked, dulled or faded from lack of proper maintenance, buffing may be necessary to bring back the shiny appearance. Hand buffing with #7 rubbing compound or power buffing with glazing compound #1 will quickly restore the surface; however, always seek certified assistance before attempting to restore your boat's finish.

## UPHOLSTERY

Regular washing with mild detergent and warm water or non-solvent type automotive vinyl cleaner is sufficient to keep the cushions, canopy top and other vinyl coverings in good condition. Keep the cushions from becoming soaked and dry off thoroughly after washing to prevent mildew accumulation after the boat is covered. Position the cushions up in the boat when covered to allow air circulation and spray with mildew repellent.

For tough stains on vinyl such as adhesive and rust, use a citrus cleaner followed by a mild detergent and warm water. For ink stains, apply denatured alcohol and wipe off. Note that some products such as suntan lotion, shoe polish and wet leaves may stain permanently.

Although not always convenient, minimizing the boat's contact with damaging ultraviolet (UV) rays and storing removable seats and canopies indoors when not in use will increase the longevity of vinyl upholstery.

### NOTICE

*Certain automotive, household and industrial cleaners can cause further damage and discoloration. Be cautious when using solvents and dry-cleaning fluids, or products that contain dyes such as waxes. Whenever cleaning stubborn stains, test the treatment in an unseen area first. Use the following stain treatments with discretion. Between steps, be sure to rinse thoroughly with plenty of clean water and allow to dry.*



## INTERIOR FABRIC

Clean interior fabrics with cleaner approved for use with your boat's fabrics. Using inappropriate cleaners can permanently damage fabrics. Always follow the cleaner's manufacturer's instructions carefully. Always test cleaners in an unseen area first.



### **WARNING**

***Toxic Fumes Hazard: Dry cleaners require adequate ventilation during use. Open all hatches and windows before application.***

Soft cleansers or soap and water will remove most marks or stains on wallpaper. Lightly rub the mark or stain with a sponge or soft cloth and dry with a clean cloth.

## CANVAS COVERS AND BIMINI TOPS

In most cases, boat canvas receives more abuse than any other item on a boat. Canvas must be regularly maintained for long life and top performance. Moisture, dirt and chemicals from industrial fallout, heat, ultraviolet rays and salt water can all contribute to the deterioration of canvas. These elements can cause serious damage if left unchecked. The following guidelines will help you keep your canvas in good condition for years to come:

- Convertible tops are not designed for extended exposure to the elements as a protective cover at dockside or when the boat is in storage. Use a full, properly fitted, light-colored mooring cover for these purposes.
- If canvas gets wet during use, remove any side curtains and open the windshield to allow both sides and all seams to dry. The air circulation will allow all canvas to dry and prevent the growth of mildew. Never store wet or damp canvas.
- Occasionally set up all canvas and curtains, and hose down with fresh water to remove accumulated soot and dirt. Sweep or brush the underside of the canvas to prevent the accumulation of dirt and mildew.
- Wet canvas must be allowed to dry thoroughly before storage. Never allow canvas to dry loose since shrinkage can occur. Install and stretch all canvas fully on your boat when drying.
- Never allow the canvas to be exposed to direct sunlight for long periods of time.
- Use care when handling clear vinyl curtains and windows to prevent scratching. Never use cleaners on clear vinyl curtains and windows. Use clean water and a soft, clean cloth.
- Never fold canvas where creases can form in the material. Loosely roll canvas to prevent damage.
- Never store canvas in plastic bags. Store canvas in a dry, well-ventilated compartment.



- Outer canvas surfaces can be cleaned with a soft scrub brush and either automotive convertible top cleaners or household cleaners suitable for use on vinyl surfaces. The underside of the canvas may be periodically sprayed with a spray disinfectant to prevent mildew.
- Never store or dock the boat under trees. Tree sap is very corrosive to canvas and can also be harmful to gelcoat and vinyl interiors.
- Adjust canvas top bows to eliminate pockets in which rainwater can accumulate. The weight of accumulated water can collapse or damage the canvas top.
- Lubricate snaps and zippers regularly. Vaseline, silicone spray or paraffin are effective lubricants. Never force snaps and zippers that are stuck.
- Never trailer the boat with the convertible top in the mounted position. Dismantle, roll and securely store all canvas while trailering your boat to prevent wind damage.

## CARPET

Occasional vacuuming and washing with mild detergent and warm water or household carpet cleaners will keep the carpet clean. Thoroughly wash the detergent out of the carpet with clean water. Let the carpet dry in the sun to prevent any mildew or odor caused by moisture.

To clean mildew off the carpet, first check the cleaner on a small area of carpet that is hidden to determine compatibility of cleaner and carpet. "FISH ATTRACTANTS," which are commonly sprayed on lures and some insect repellants, will cause deterioration of the carpet backing. Spray these formulas away from the boat carpet and clean any spills promptly. DO NOT use pressure sprayers to clean boat carpet.

## WINDSHIELD

A clean windshield is important. If the boat is equipped with a glass windshield, applying a nonabrasive glass cleaner with a soft cloth will remove most dirt. Clean tinted Plexiglas or plastic windshields with a mild soap solution and damp cloth only. Harsh detergents, solvents, chemicals or dry cloths used on any glass or plastic windshield will scratch the surface.

## WINDOW CHANNELS

Nylon pile is typically used in sliding window channels. Never use any products that contain bleaching solutions to clean window channels or seals. Use only a mild detergent and water solution for cleaning. If windows stick, spray the channels with silicone spray while working the window back and forth.





## TEAK

Teak is an organic and porous wood that contains natural oils and silicates that make it ideal for marine applications.

Depending on the interior or exterior application of the teak used on the boat, different cleaning and refinishing procedures may be required. The following information is intended as a guide. Always consult the boat dealer before performing any cleaning or refinishing procedures.

### Cleaning

Only use approved teak cleaners and follow the manufacturer's instructions and warnings carefully. The use of unapproved teak cleaners, such as general or all-purpose cleaners, rust removers or cleaners containing acid, will damage the teak and/or fasteners and the caulking used to secure the teak.

When cleaning areas that have caulking in the seams between teak boards, use special care to prevent damaging or removing the caulking. Do not use cleaners containing chlorine.

When cleaning, always scrub across the grain using a Scotch-Brite™ type scrubbing pad or plastic bristle brush. Scrubbing with the grain may cause damage by removing soft grains from the teak. On larger areas, rotary scrubbers can be used.

### Refinishing

Lightly sand all teak surfaces periodically to smoothen the exposed surfaces. This exposes less wood grain area to the elements and helps prevent the exposed grains from trapping dirt.

When sanding teak, the grit of the sandpaper and sanding method used depend on the condition of the teak. Minor scratches may be repaired using sandpaper (400 to 1000 grit). Major scratches and refinishing may require a sanding machine and the use of lower grit sandpaper. When sanding, always hold the sandpaper or pad flat on the teak to avoid gouging the teak.

To repair chips, cracks, plugs or breaks, special epoxies are available specifically for use with teak. When replacing caulking, take care to keep the seams dry and clean. Always use caulking approved for teak use and follow the manufacturer's instructions and warnings carefully. Immediately repair damaged areas or areas that always appear wet, as water leaking between seams or under the decking can cause further damage.



SECTION  
**10** **GENERAL CARE AND MAINTENANCE**

### **Sealants and Oils**

The use of sealants or surface finishes on exterior applications is generally not recommended and should only be applied after consulting with the boat dealer. Never use sealants containing kerosene or petroleum products.

As teak is a porous material that contains natural oils and silicates, the use of protective oils or sealants is not recommended for exterior and most interior applications. Applying oil to teak can cause personal safety hazards, permanent teak damage and increased maintenance, and can shorten the life of the teak. In addition, teak oils can be harmful to other materials such as caulk, vinyl, plastics, gelcoats, etc.

### **BILGE**

A boat's bilge area accumulates oil and greasy dirt over a period of time and should be cleaned periodically. Consult the boat dealer for recommendations on special bilge cleaning products and procedures.

### **BILGE PUMP**

Periodically check the bilge pump(s) inlet screens and hoses for obstructions and debris. Foreign materials can clog the screen and hoses or become lodged in the bilge pump impeller, which can cause the pump to malfunction. Periodically check the operation of the bilge pump and float switch, if equipped. Inspect all wiring, clamps and hoses for tightness on a regular basis.

### **DETECTORS**

Inspect fire, gas vapor and CO detectors periodically for proper operation. See the manufacturer's information for periodic testing procedures.

### **TRIM TABS**

Periodically inspect the trim tabs for damage and leaks. Check the hydraulic pump fluid level periodically and fill with the recommended fluid.



## ALCOHOL STOVES

Carefully read and follow the stove manufacturer's operating and maintenance procedures:

- Use only denatured alcohol labeled specifically for marine use.
- Never operate the stove while underway.
- Never fill the stove near an open flame or hot object.
- Wipe up any spilled alcohol prior to lighting the stove.

## RAW WATER SYSTEM

Periodic maintenance guidelines:

- Lubricate and operate all seacocks, checking for proper operation.
- Inspect, clean or replace strainers as necessary.
- Check for leakage at all hull fittings, lines, connections, valves, etc.
- Check all raw water-related pumps, controls and appliances for proper operation.
- Clean and flush all lines and systems with clean, fresh water and approved cleaners.

## FRESHWATER SYSTEM

Perform the following maintenance monthly to help keep the freshwater system clean and sanitary.

- Drain the freshwater tank completely using all faucets, showers, etc. Refill tank with at least 20 gallons of clean, fresh water and drain again.
- Clean freshwater pump inlet filter screen, if equipped.
- Replace freshwater system filter(s), if equipped.
- Clean city water inlet strainer, if equipped.
- Flush city water system using all faucets and showers.

If water in the tank has stagnated and you suspect that the freshwater system may be contaminated, sanitize the system.

**To sanitize:**

- Drain the freshwater tank completely using all faucets and showers.
- Mix a solution of 1/4 cup household bleach to one gallon of water for every 15 gallons of tank capacity. Pour the solution into the freshwater tank.
- Fill the tank with clean, fresh water.
- Turn freshwater pump on and bleed air from all faucets, showers, etc.
- After approximately three hours, drain the system completely.
- Flush the system with one full tank of water.
- Fill tank with clean, fresh drinking water.

**If you can smell or taste bleach in the water:**

- Drain the system completely.
- Mix a solution of one quart of white vinegar to five gallons of water. Pour the solution into the freshwater tank.
- Allow the solution to remain in the tank until you have logged approximately one hour of cruising time. Boat motion will move the vinegar/water solution around to help clean the tank.
- Allow the solution to remain in the tank for at least one week.
- Drain the freshwater system completely.
- Flush the system with one full tank of water.
- Fill the tank with clean, fresh drinking water.

**HEAD AND WASTE CONTAINMENT SYSTEM****Head (Marine Toilet)**

Periodic maintenance guidelines:

- Use a non-abrasive cleaner for the bowl.
- A light coating of a general-purpose marine lubricant on the pump rods and slides will reduce friction of moving parts.
- Use recommended deodorant and lubricant for the internal parts of the head.
- Always flush the head completely to clear any waste from the bowl and/or lines to the waste tank. This can prevent odor and waste buildup in the lines. To reduce odors, pour and keep some fresh water in the bowl after flushing.



### Waste Holding Tank

If the boat has an optional waste holding tank installed, various chemicals are available to control odors and help break down solids. Consult your local marine dealer for product suggestions. After the holding tank is emptied, fill the tank with fresh water and pump it out again to rinse.

#### **NOTICE**

*The discharge of any type of debris or waste, including, but not limited to, food, trash, garbage, oil, fuel, liquids and human waste, is highly restricted, if not unlawful, in most waterways. Never discharge anything into the water.*

### SAFETY EQUIPMENT

Periodically check the safety equipment for damage, general condition and operation when applicable. Always replace safety equipment that is in question or in need of repair:

- Fire extinguisher
- Life jackets
- Visual distress signaling devices
- Audible signaling devices
- Navigational lights
- Emergency radios or Emergency Position Indicating Radio Beacon (EPIRB)
- First aid kit
- Batteries in electronic devices

### GENERAL BOATING EQUIPMENT

Periodically check the general equipment on board for damage, general condition and operation when applicable. Always replace equipment that is in question or in need of repair.

- Anchors and anchor lines
- Boat hook
- Dock fenders
- Foul weather gear/clothing
- Mooring lines
- Oars/paddles
- Tool kit
- Tow line



SECTION  
**10** GENERAL CARE AND MAINTENANCE

## TRAILER

Periodically check the general trailer components for damage, general condition and operation when applicable. Always replace trailer components that are in question or in need of repair.

- Lights
- Electrical connectors
- Tires (condition and pressure)
- Wheel lug nuts and studs
- Wheel valve stems
- Wheel bearings
- License plate and holder
- Rollers, bunks and hardware
- General fasteners (missing, loose or corroded)
- Safety chains or straps
- Winch, winch strap and hooks
- Trailer coupler and latch
- Frame, axle and springs
- Spare tire and wheel
- Brakes and actuator assembly

# Section 11

## WINTERIZATION AND STORAGE

The boat may be equipped with a variety of specialized systems and components. The following basic and typical information may not apply to your specific application. This section may not cover all systems or components on the boat. Consult the boat dealer for assistance.

Winterizing or storing the boat for extended periods of non-use requires special preparation to prevent boat and system damage. Without proper preparation, if the boat is not used or is stored for extended periods of time, internal parts of the engine may become corroded from lack of lubrication. If the boat is stored in freezing temperatures, water inside the bilge, engine cooling system or boat water systems may freeze and cause damage. Be sure to keep up with all annual maintenance during winterization.

Before performing any winterization and storage procedures within this section, review *Safety in Section 2*.

### WINTERIZATION AND STORAGE PREPARATION

The following procedures will help prevent damage to the boat:

- While the boat is still in the water, fill fuel tank(s) with fresh fuel and add the proper amount of fuel stabilizer/conditioner according to the engine manufacturer's recommendations. Operate the boat for at least 15 minutes to be sure that the treated fuel has reached the engine.

#### **NOTICE**

*If you plan to store the boat for more than three months in either a humid environment, extreme temperatures or outdoors, "fog" the engine with a corrosion-preventing fogging oil according to the propulsion system manufacturer's recommendations. See the Engine Operator's Manual for more information.*

- Once the boat is removed from the water, remove the bilge drain plug immediately. Store the drain plug in a plastic bag and tape it to the throttle control lever for easy accessibility the next time you use the boat.
- Inspect all sacrificial corrosion protection anodes for excessive wear and replace as necessary.
- Check all thru-hull fittings and other fasteners for tightness and leakage.
- Thoroughly clean the hull, deck and interior of the boat as soon as you remove it from the water; marine growth is easier to remove when it is wet.
- Always allow all boat compartments to air dry for a couple of days to prevent mildew from trapped moisture. If you use shrink wrap, always allow for ventilation to prevent mildew from trapped moisture.



## WINTERIZATION AND STORAGE

- Apply a coat of wax to the entire surface of the boat and rust inhibitor on all metal parts.
- Clean all traces of dirt, oil, grime and grease from the engine and bilge.
- After washing, raise the bow of the boat high to allow as much water as possible to drain while performing other storage preparations.
- Touch up areas where paint has been removed.
- Prepare the engine for storage according to the *Engine Operator's Manual*. Flush the engine cooling system with clean water and/or a nontoxic antifreeze mixture approved for marine use. Never exceed the maximum engine rpm for flushing recommended as stated in the manual.
- Perform all scheduled maintenance for the engine and boat equipment. See the *Engine Operator's Manual* and all equipment manufacturer's information for periodic and annual maintenance procedures.
- Turn off all electrical switches and breakers.
- Remove all batteries from the boat. Clean, fully charge and store the batteries in an area outside the boat not subject to freezing temperatures. Never store batteries close to heat, sparks or open flames.
- Clean all interior upholstery, furniture, appliances, etc.
- Open all water faucets, drains and seacocks, and thoroughly drain all tanks and water lines. Use the freshwater pump to empty all the water from the freshwater storage tank and intake lines. Manually disconnect any lines that may have residual water trapped.
- Empty all water from the water heater.
- Empty and clean the waste containment system and flush with fresh water.
- Use nontoxic antifreeze approved for marine use to prevent freeze damage in the freshwater, raw water and waste systems. Consult your local marina or certified marine technician for recommendations for your system.
- Pest/rodent repellents may help prevent damage to the boat during storage.

### STORING ON A CRADLE OR BLOCKS

- When storing a boat on support other than the proper trailer, make sure the hull is supported properly to prevent hull damage. Most cradles are custom-built to support the boat's hull.
- Put the cradle or blocks on a hard, level surface capable of supporting the combined weight of the cradle and the boat.





- When using blocks with jack stands, always use jack stands that are rated for more than the required load, making sure they are securely positioned so they cannot move under the load. Use a minimum of three blocks to support the keel and each side of the boat where applicable. Use a minimum total of nine jacks and/or blocks.
- Position the boat to allow for adequate draining from rain or snow.
- Cover the boat to prevent the collection of rain, snow or debris. When using a cover, allow ventilation for residual moisture and condensation to escape. Never cover or plug the bilge drain hole.
- Position the lower unit drive in the DOWN position.

## STORING ON A TRAILER

- Be sure the trailer supports are adjusted to properly support the boat's hull.
- Repack the trailer wheel bearings with water-resistant wheel bearing grease.
- Park the trailer and boat in a protected area with the lower unit drive in the DOWN position.
- Loosen tie-downs and winch line, but be sure the boat is resting properly on hull supports.
- Lift the trailer and place blocks under the trailer frame to relieve weight on trailer tires and springs. Position the boat to allow for adequate draining from rain or snow.
- Cover the boat to prevent the collection of rain, snow or debris. When using a cover, allow ventilation for residual moisture and condensation to escape. Never cover or plug the bilge drain hole.

## RECOMMISSIONING AFTER STORAGE

- Remove blocks from under the trailer frame.
- Tighten tie-downs and the trailer winch line.
- Check tire pressure and lug nut tightness on the trailer.
- Inspect the hull for damage.
- Charge and install all batteries.
- Check the bilge blower vents for obstructions and blower operation.
- Check the bilge pump and float switch for proper operation.
- Inspect all battery and electrical wiring for loose connections and/or damage.



# WINTERIZATION AND STORAGE

- Check the fuel system for leaks or damage. Verify the condition of all hoses and fuel line. Should a fuel hose need replacing, use only USCG-approved hose. Check hose labels for exact type of replacement. Be sure all hose clamps are tight.
- Check the engine and bilge for signs of nesting animals; clean as necessary.
- Check the entire engine for cracks and leaks caused by freeze damage.
- Check the condition of all hoses and clamps for tightness.
- Clean the bilge area and install the boat bilge drain plug.
- Lubricate all seacocks and check for proper operation.
- Install all drain plugs in strainers and seacocks.
- Close all drains and valves that were opened during winterization.
- Open all faucets and fill freshwater holding tank with about 20 gallons of water. Turn freshwater pump on to allow water to flow through all faucets before closing them. Thoroughly flush all lines and appliances with fresh water.
- Fill the freshwater tank.
- Perform any annual maintenance not performed during winterization. See the *Engine Operator's Manual* and all equipment manufacturer's information for periodic and annual maintenance procedures.
- Check the engine's cooling water intake areas and screens for obstructions.
- If the engine uses a self-contained freshwater cooling system (stern drive only) and was drained for storage, fill the system with fresh coolant solution. Check the *Engine Operator's Manual* for specific procedures.
- Check all engine and generator exhaust connections for exhaust leakage or damage.
- Check and lubricate the steering system.
- Check all navigational lights.
- Check all controls, gauges, boat systems, accessories and related equipment for proper operation.
- Check all fire extinguishers for charge level.
- Inspect all safety equipment for condition and operation as applicable.
- When possible, briefly start and run the engine(s) using proper water supply equipment to check that the engine does start and there are no major operational problems.

## NOTICE

*If fogging oil was used during winterization, the engine will emit excessive white smoke upon initial start-up. This condition is normal and will diminish once the fogging oil has been cleared through the engine.*



- Once the boat is in the water, start the engine.
- Start the engine(s) and watch the gauge readings closely, checking for leaks and abnormal noises.
- Keep speeds low for the first 15 minutes until the engine has reached normal operating temperature.
- See the *Engine Operator's Manual* and all equipment manufacturer's information for additional recommendations.

## PRESEASON ELECTRONICS CHECKLIST

When recommissioning the boat at the beginning of a new season, it's important to test the navigation and communication electronics for proper operation. If adjustments are possible, read the manufacturer's information. Some adjustments can only be made by the electronics dealer.

- Firmware/Software - Go to each electronics manufacturer's website and check for any updates for your model. Follow the manufacturer's instructions for downloading and installation.
- Chartplotter - Check online to see if your charts/maps are up-to-date. Follow the manufacturer's instructions for downloading and installation.
- EPIRBs - Perform a self-test to any and all EPIRBs according to the manufacturer's instructions. Check battery and replace if necessary.
- VHF Radio - Do not "radio check" on channel 16. Perform an internet search for "automated radio check service" to see if one is available in your area. Some services will also check the DSC function of the radio if so equipped.
- AIS - Ask another AIS-equipped boat in the area to verify your signal target and associated MMSI information. Check that your AIS is picking up the other boater's target and verify their information for them.
- GPS - Check your GPS's accuracy against a good handheld unit (phones are not as accurate). If you have AIS, confirm longitude and latitude against the AIS data.
- Autopilot - While underway, check the autopilot heading reading with your GPS and ensure that it follows GPS waypoints.
- Station Locking - Enable station locking in open water and confirm position holding with GPS.
- Radar - View relative position of shoreline and other targets to display-long and short. Determine if display clarity has changed.



- Display Panels - Check display settings, especially alarms and notifications.
- Fish and/or Depth Finder - Check shallow and deep water readings in known waters. Verify the alarms are working properly. Observe fish detection and bottom structure for anomalies.
- Boat Monitor - Test the essential monitoring functions and notification by activating the system and manually raising the bilge float switch; unplug the shore power cable, test security functions and any available systems control with your smartphone. Confirm GPS position and geo-fencing area if applicable.

## LIFTING

### NOTICE

*Consult the boat dealer for proper lifting instructions for the boat.*

Attempt to lift or hoist boats only if you are qualified or experienced with this procedure. This procedure requires special equipment and experience. Do not attempt to lift or hoist the boat alone; damage, personal injury or death can occur.



### WARNING

***Crush Hazard: Special equipment is necessary to lift the boat and/or engine. Always use lifting equipment with sufficient capacity to lift the boat and/or engine.***

If the boat is to be removed from the water without a trailer, follow these guidelines:

- Cover lifting cables with a rubber hose or other protectors to prevent damage to the finish.
- Attach guidelines to the bow and stern to control movement.
- Use spreader bars and keep lifting pressure vertical to prevent side load damage.
- Keep the bow slightly higher than the stern to prevent engine damage.

# WINTERIZATION AND STORAGE

SECTION  
**11**

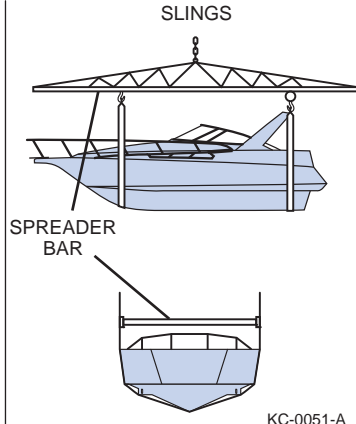
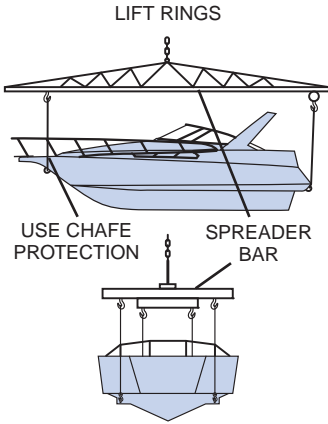



SECTION

**11**

## WINTERIZATION AND STORAGE

This Page Intentionally Left Blank

# Section 12

## TROUBLESHOOTING

The following information will assist you in identifying basic performance, mechanical and electrical problems. This information is intended as a general troubleshooting guide and may describe items that are not applicable to the boat.

If you detect a problem with the engine, see the *Engine Operator's Manual*. If you detect an equipment or boat system problem, see the manufacturer's information for that item.

Before performing any troubleshooting procedures within this section, review *Safety in Section 2*.

### NOTICE

*Certain problems may require specialized skills and tools. Always consult qualified personnel before making any repairs or modifications.*

PROBLEM	POSSIBLE CAUSES
<b>Engine will not crank</b>	<ul style="list-style-type: none"> <li>• Engine emergency stop switch lanyard not connected</li> <li>• Shift/throttle control not in the NEUTRAL position</li> <li>• Main circuit breaker open</li> <li>• Battery switch is in the OFF position</li> <li>• Battery terminals or wiring connections corroded</li> <li>• Low battery voltage</li> <li>• Faulty ignition switch</li> <li>• Engine problem</li> </ul>
<b>Engine cranks but will not start</b>	<ul style="list-style-type: none"> <li>• No fuel in tank</li> <li>• Fuel tank valves closed to engine</li> <li>• Fuel filter clogged</li> <li>• Flame arrestor dirty, if equipped</li> <li>• Contaminated fuel</li> <li>• Engine problem</li> </ul>



PROBLEM	POSSIBLE CAUSES
<b>Poor boat performance</b>	<ul style="list-style-type: none"><li>• Contaminated fuel</li><li>• Uneven load distribution</li><li>• Excessive load</li><li>• Improper power trim position</li><li>• Improper trim tab position</li><li>• Improper propeller selection</li><li>• Excessive water in bilge</li><li>• Damaged or obstructed propeller</li><li>• Marine growth on hull</li><li>• Damaged hull</li><li>• Engine system problem</li><li>• Plugged flame arrestor, if equipped</li></ul>
<b>Throttle/shifting control problems</b>	<ul style="list-style-type: none"><li>• Corroded cable</li><li>• Excessive bends or kinks in cable</li><li>• Engine system problem</li></ul>
<b>Excessive vibration</b>	<ul style="list-style-type: none"><li>• Damaged or obstructed propeller</li><li>• Bent propeller shaft</li><li>• Engine system problem</li></ul>
<b>Electrical problems</b>	<ul style="list-style-type: none"><li>• Blown fuse/breaker or open circuit</li><li>• Loose or corroded wiring connections</li><li>• Defective switch or gauge</li><li>• Weak or discharged battery</li><li>• Loose shore power connection</li></ul>
<b>No power to AC outlets</b>	<ul style="list-style-type: none"><li>• Ground fault circuit interrupter tripped</li><li>• Loose shore power connection</li><li>• AC breaker open</li><li>• Faulty generator operation</li></ul>
<b>Sink/shower water supply does not operate</b>	<ul style="list-style-type: none"><li>• Freshwater pump circuit breaker is in the OFF position</li><li>• Freshwater tank is empty</li><li>• Freshwater pump is defective</li><li>• Low battery voltage</li></ul>





PROBLEM	POSSIBLE CAUSES
<b>Head will not empty</b>	<ul style="list-style-type: none"><li>• Head circuit breaker is in the OFF position</li><li>• Low battery voltage</li><li>• Head seacock closed</li><li>• Discharge valve closed</li><li>• Line to holding tank blocked</li></ul>
<b>Erratic or no speedometer reading</b>	<ul style="list-style-type: none"><li>• Disconnected, kinked or plugged pickup tube or pitot</li><li>• Speedometer gauge faulty</li></ul>



SECTION

12

## TROUBLESHOOTING

This Page Intentionally Left Blank

## Section 13

# GLOSSARY OF NAUTICAL TERMS

**ABOARD** – On or in the boat.

**ABYC** – American Boat and Yacht Council, Inc.

**AFLOAT** – On the water.

**AFT** – Toward the rear or stern of the boat.

**AGROUND** – Touching bottom.

**AMIDSHIP** – Center or middle of the boat.

**ANCHOR** – (1) An iron casting shaped to grip the lake bottom to hold the boat.

(2) The act of setting the anchor.

**ASHORE** – On the shore.

**ASTERN** – Toward the stern.

**BAIL** – To remove water from the bottom of the boat with a pump, bucket, sponge, etc.

**BAITWELL** – A miniature livewell used to store and keep live bait alive and healthy.

**BEAM** – The widest point on the boat.

**BEARING** – Relative position or direction of an object from the boat.

**BILGE** – The lowest interior section of the boat hull.

**BILGE KEELS** – The raised areas or aluminum extrusions on the bottom of a boat that parallel the keel.

**BOARDING** – To enter the boat.

**BOUNDARY WATERS** – A body of water between two areas of jurisdiction; i.e., a river between two states.

**BOW** – The front of the boat.

**BULKHEAD** – Vertical partition (wall) in a boat.

**BUNKS** – Carpeted trailer hull supports.

**BURDENED BOAT** – Term for the boat that must “give-way” to boats with the right-of-way.

**CAPACITY PLATE** – A plate that provides maximum weight capacity and engine horsepower rating information. It is located in full view of the helm.

**CAPSIZE** – To turn over.

**CAST-OFF** – To unfasten mooring lines in preparation for departure.

**CENTER LINE** – A lengthwise imaginary line which runs fore and aft with the boat’s keel.

**CHINE** – The point on a boat where the side intersects (meets) the bottom.

**CLEAT** – A deck fitting with ears to which lines are fastened.

**CONSOLE** – Also called helm. The steering wheel area of the boat.

**CRANKING BATTERY** – The main battery used for engine starting and electrical circuits.

**CURRENT** – Water moving in a horizontal direction.

**DECK** – The open surface on the boat where the passengers walk.

**DEEP-CYCLE BATTERIES** – Special long-running batteries which can be repeatedly discharged and recharged without significant loss of power.

**DOLLY WHEEL** – A rolling jack assembly at the front of the trailer used for positioning the coupler during trailer hookup.



**DRAFT** – The depth of the boat below the waterline, measured vertically to the lowest part of the hull.

**ELECTROLYSIS** – The breakup of metals due to the effects of galvanic corrosion.

**FATHOM** – Unit of depth or measure; 1 fathom equals 6 feet.

**FENDERS** – Objects placed alongside the boat for cushioning. Sometimes called bumpers.

**FORE** – Toward the front or bow of the boat. Opposite of aft.

**FREEBOARD** – The distance from the water to the gunwale.

**FUEL SENDING UNIT** – The electrical device that is mounted on the outside of a built-in fuel tank and controls the dashboard fuel gauge.

**GIVE-WAY BOAT** – (1) Term for the boat that must take whatever action necessary to keep well clear of the boat with the right-of-way in meeting or crossing situations. (2) The burdened boat.

**GUNWALE** – The rail or upper edge of a boat's side.

**HEAD** – A marine toilet.

**HELM** – The steering wheel or command area.

**HULL** – The body of the boat.

**HYPOTHERMIA** – A physical condition where the body loses heat faster than it can produce it.

**IN-LINE FUSE** – A type of protective fuse located in the power wire of a direct current (DC) circuit usually near the battery.

**KEEL** – The lowest portion of the boat; extends fore and aft along the boat's bottom.

**LIFE JACKET** – A buoyant, wearable jacket that, when properly used, will support a person in the water; also see PFD.

**LIST** – Leaning or tilt of a boat toward the side.

**MAKING WAY** – Making progress through the water.

**MARINE CHART** – Seagoing maps showing depths, buoys, navigation aids, etc.

**MOORING** – An anchor, chain or similar device that holds a boat in one location.

**NAVIGATION AID** – Recognizable objects on land or sea such as buoys, towers or lights which are used to fix position to identify safe and unsafe waters.

**NMMA** – National Marine Manufacturers Association.

**NO-WAKE SPEED** – The speed at which a boat travels to produce an imperceptible wake.

**PFD** – A buoyant personal flotation device used to support a person in the water; also see Life Jacket.

**PITOT TUBE** – See Speedometer Pickup Tube.

**PLANING HULL** – A hull designed to lift, thereby reducing friction and increasing efficiency.

**PORPOISE** – A condition in which the bow bounces up and down caused by trimming the engine too far out.

**PORT** – (1) The left side of a boat when facing the bow. (2) A destination or harbor.

**PRIVILEGED BOAT** – Term used for the boat with the right-of-way.

**RIGHT-OF-WAY** – Term for the boat that has priority in meeting or crossing situations. The stand-on or privileged boat.



**RULES OF THE ROAD** – Regulations for preventing collisions on the water.

**SPEEDOMETER PICKUP TUBE** – Also called pitot tube. The plastic device that extends below the bottom of the boat. It connects to the speedometer with plastic flexible tubing.

**SPLASHWELL** – The section of an outboard-equipped boat that is just forward of the transom.

**STAND ON BOAT** – Term for the boat that must maintain course and speed in meeting or crossing situations. The privileged boat.

**STARBOARD** – The right side of the boat when looking toward the bow.

**STERN** – The back of the boat.

**STOW** – To pack the cargo.

**SURGE BRAKES** – A type of trailer braking system designed to automatically actuate when the tow vehicle's brakes are applied.

**TRANSDUCER** – The unit that sends/receives signals for the depth sounder.

**TRANSOM** – The transverse beam across the stern.

**TRIM** – Fore to aft and side to side balance of the boat when loaded.

**UNDERWAY** – Boat in motion; i.e., not moored or anchored.

**USCG** – United States Coast Guard.

**WAKE** – The waves that a boat leaves behind when moving through the water.

**WATERWAY** – A navigable body of water.

**V-PAD** – A modified vee-hull design with a small, flat area in the keel aft.

**VISUAL DISTRESS SIGNAL** – A device used to signal the need for assistance such as flags, lights and flares.



SECTION  
**13** **GLOSSARY OF NAUTICAL TERMS**

This Page Intentionally Left Blank

# INDEX

## Numerics

5-pin wiring connector ..... 8-5

## A

A word on AIS ..... 2-27

Accelerating and running

underway ..... 7-14

Accidents ..... 3-2, 4-7

After refueling ..... 7-8

Alcohol ..... 3-3

Alcohol stoves ..... 10-17

Aluminum ..... 10-10

American Boat & Yacht Council .... 1-6

American Red Cross ..... 1-6

Anchor line ..... 7-23

Anchors and anchoring ..... 7-23

Anodes ..... 10-7, 11-1

Antifouling bottom paint ..... 10-11

Aquatic Invasive Species (AIS) ..... 3-9

Aquatic vegetation/weeds ..... 5-3

Audible (sound) signals ..... 2-19, 6-3

Audible alarms ..... 9-32

Audible signaling devices .. 2-11, 2-19

Automatic charging relay (ACR) .... 9-5

Automatic fire extinguishing

system ..... 9-39

Automatic trim ..... 9-25

## B

Backing up ..... 8-9

Basic safety rules ..... 2-1

Battery ..... 9-34

Battery switches ..... 9-34

Before refueling ..... 7-7

Bell ..... 6-3

Bilge ..... 10-16

Bilge pump ..... 9-38, 10-16

Bilge pump switch ..... 9-37

Bilge pump system ..... 9-38

Boarding ..... 7-4

Boarding switches ..... 9-36

Boat loading ..... 7-4

Boat monitoring systems ..... 9-22

Boat Owners Association of

The United States ..... 1-6

Boat system failure ..... 4-6

Boat ventilation system ..... 9-38

Boating accident ..... 3-2

Boating regulations ..... 3-1, 6-1

Boating under the influence ..... 3-3

BoatU.S. Foundation for

Boating Safety Hotline ..... 1-6

Bow thrusters ..... 9-24

Buffing ..... 10-12

Buoys ..... 6-7, 6-11, 6-12, 6-13, 6-14

## C

Canvas ..... 10-13

Canvas cover ..... 10-13

Capacity plate ..... 7-4

Capsizing and flooding ..... 4-5

Carbon monoxide poisoning ..... 2-34

Carpet ..... 10-14

Chain counter ..... 7-26

Checks during and after

operation ..... 7-16

Circuit breakers ..... 10-5

City water hookup ..... 9-41

Cleaners ..... 10-12

Cleaning ..... 10-11

Cleaning agents ..... 3-9

Cold water ..... 5-2

Cold weather and cold or frozen

water conditions ..... 5-2

Collision ..... 4-7

Communication equipment ..... 4-1

Compass ..... 9-32

Compliance plate ..... 1-3

Connecting VHS-DSC with

GPS ..... 2-26

Considerations for longer

voyages ..... 7-2

Cooling system ..... 10-6

Corrosion ..... 10-6, 10-10

Courtesy switches ..... 9-36

CPR ..... 4-1

Crossing ..... 6-6

Cruising limitation ..... 2-31



**D**

Dams ..... 5-3  
Dams and spillways ..... 5-3  
Danger signal ..... 6-3  
Daymarks ..... 6-12  
Daymarks/Dayboards ..... 6-9  
Debris ..... 5-3  
Detectors ..... 10-16  
Diameter ..... 9-19  
Digital switches ..... 9-25  
Display panels ..... 9-21  
Distress signal ..... 3-4  
Distress signaling devices ..... 4-1  
Distress signals ..... 6-3  
Docking ..... 7-21  
Drain plug ..... 11-1  
Driving defensively ..... 2-29  
Drugs ..... 3-3  
Dual-prop drives ..... 9-21

**E**

Electrical system ..... 9-3, 9-19  
Electrolysis ..... 10-6  
Electronic leakage circuit  
interrupter (ELCI) ..... 9-12  
Electronic propulsion controls ..... 9-23  
Electronic steering  
system ..... 9-18, 9-23  
Emergencies ..... 4-1, 4-7  
Emergency assistance ..... 3-4  
Emergency checklist ..... 4-1  
Emergency position indicating  
radio beacons (EPIRBs) ..... 2-28  
Emergency stop switch ..... 9-35  
Emissions ..... 3-10  
Engine cooling system ..... 11-2  
Engine hour meter ..... 9-31  
Engine lubrication system ..... 9-2  
Engine warning alarm system ..... 9-32  
Engine water temperature  
gauge ..... 9-30  
Exhaust emissions ..... 3-10

**F**

Fasteners ..... 10-10

Filter, pump and pressure

accumulator ..... 9-40  
Fire and explosion ..... 4-3  
Fire extinguishers ..... 2-12, 2-13  
Fires ..... 2-13  
First aid/medical emergencies ..... 4-1  
Fishing ..... 3-5  
Flags ..... 5-4  
Float plan ..... 7-1  
Float switch ..... 10-16  
Fog conditions ..... 5-2  
Fogging oil ..... 11-1  
Freezing temperatures ..... 11-1  
Freshwater system ..... 9-39, 10-17  
Freshwater tank ..... 9-41  
Fuel (gasoline) ..... 7-6, 10-1  
Fuel filler ..... 7-8  
Fuel level gauge ..... 9-29  
Fuel management ..... 7-5  
Fuel stabilizer ..... 11-1  
Fuel suppliers ..... 7-5  
Fuel system ..... 9-1, 10-1  
    Fuel ..... 10-1  
    Fuel filter ..... 10-1  
    Fuel tanks ..... 9-1  
Fuel-burning appliances ..... 9-48  
Fueling ..... 7-5, 7-7, 7-8  
Fuses ..... 10-4

**G**

Galvanic corrosion ..... 10-6, 10-11  
    Anodes ..... 10-6  
Gauges ..... 9-27  
Gauges/Instruments ..... 9-27  
Gelcoat ..... 10-12  
General boating equipment ..... 10-19  
General operation of an LPG  
appliance ..... 9-50  
Generator ..... 9-11  
Getting underway ..... 7-9  
Global maritime distress and  
safety system (GMDSS) ..... 2-24  
Glossary of nautical terms ..... 13-1  
Green light ..... 6-3





Gross Vehicle Weight Rating (GVWR) ..... 8-2  
Ground fault circuit interrupters ... 9-14

**H**

Hazard information ..... 2-32  
Hazard labels ..... 2-4  
Hazards ..... 5-2, 5-4  
Head and waste containment system ..... 9-45  
Helm ..... 7-10  
Helm and control switches ..... 9-33  
Hitch ball and trailer coupler ..... 8-3  
Horn ..... 6-3  
Horn switch ..... 9-36  
Hot water heater ..... 9-42  
Hull identification number ..... 1-2  
Hypothermia ..... 4-1, 5-2

**I**

Icy waters ..... 5-2  
Ignition switch ..... 9-33  
Inclement weather ..... 5-2  
Insurance ..... 3-2  
Interior fabric ..... 10-13  
Inverter/Charger ..... 9-14

**J**

Joystick controls ..... 9-24

**K**

Knowing the boat ..... 2-30

**L**

Lanyard ..... 9-35  
Lateral markers ..... 6-12  
Launching ..... 8-9  
Law of salvage ..... 4-3  
Life jackets ..... 2-11  
Lifting ..... 11-6  
Lighthouses ..... 6-10  
Lights ..... 9-37  
Lights and lighted structures ..... 6-9  
Lights switch ..... 9-37  
Lines and knots ..... 7-27

Liquefied petroleum gas (LPG) appliances ..... 9-49  
Livewells ..... 9-42  
Loading ..... 8-11  
Loading guidelines ..... 8-11

**M**

Maintenance ..... 10-1  
Man Overboard (MOB) ..... 4-4  
Manatee ..... 6-15  
Marine animals in distress ..... 3-6  
Marine Assistance Request Broadcast (MARB) ..... 4-2  
Marine growth ..... 10-11  
Marine head operation ..... 9-47  
Markers ..... 6-7, 6-15  
Markers, warnings and advisories ..... 5-4  
MARPOL treaty ..... 3-8  
Mayday ..... 4-2  
Medical emergencies ..... 4-1  
Meeting head-on ..... 6-5  
Mildew ..... 10-12  
Minimum on-board personal safety equipment ..... 2-11  
Minor lights ..... 6-12  
Minors ..... 3-3  
Monofilament fishing line ..... 3-6  
Mooring ..... 7-23  
Mooring buoys ..... 6-9  
Mooring line ..... 7-23  
Multi-gauges ..... 9-28

**N**

National Association of State Boating Law Administrators ..... 1-6  
National Marine Manufacturers Association ..... 1-6  
National Oceanic and Atmospheric Administration's National Weather Service ..... 1-6  
National Safe Boating Council Inc. .... 1-6  
Nautical terminology ..... 1-2  
Navigation lights switch ..... 9-37



Navigation locks ..... 6-7  
Navigation markers ..... 5-4  
Navigation rules ..... 6-1  
Navigational lights ..... 2-19  
Navigational lights and night operation ..... 6-3  
Navigational rules ..... 6-1  
Negligent operation ..... 3-4  
Neutral start safety switch ..... 9-36  
NMEA 2K network ..... 9-27  
Noise ..... 3-7

**O**

Observer ..... 2-36  
Obtaining a marine mobile service identity (MMSI) ..... 2-26  
Operating under the influence ..... 3-3  
Operation by minors ..... 3-3  
Organizations ..... 1-6  
Overboard dumping ..... 3-8  
Overtaking/passing ..... 6-4

**P**

Paints ..... 3-9  
Passengers ..... 7-9  
Performance ..... 7-4  
Pitch ..... 9-20  
Planing ..... 7-14  
Platform dragging ..... 2-33  
Power trim and tilt ..... 7-18  
Power trim operation ..... 7-19  
Pre-departure safety checklist ..... 7-3  
Preseason electronics checklist ..... 11-5  
Propeller ..... 9-19, 9-20  
Propeller selection and replacement guidelines ..... 9-20  
Proposition 65 ..... 3-10  
Protecting the boat from theft ..... 4-9  
Protecting the environment ..... 3-7  
Publications ..... 1-5

**R**

Radar ..... 2-24  
Radar reflectors ..... 2-24  
Range lights ..... 6-10

Range markers ..... 6-12  
Raw water system ..... 9-43, 10-17  
Red light ..... 6-3  
Reduced visibility ..... 5-2  
Refueling built-in fuel tanks ..... 7-8  
Registration ..... 3-2  
Registration certificates ..... 3-2  
Registration numbers ..... 3-2  
Regulations ..... 3-3, 3-6, 3-7, 3-9  
Regulatory markers ..... 6-11  
Remote operation ..... 9-26  
Reporting accidents ..... 4-7  
Reporting safety defects ..... 8-12  
Requesting assistance (non-distress call) ..... 4-2  
Restricted areas ..... 3-4  
Restricted visibility ..... 6-3  
Right-of-way ..... 6-2  
Rotational thrust ..... 7-11, 7-12  
Running aground ..... 4-6

**S**

Safe water markers ..... 6-13  
Safety ..... 7-4  
Safety and training ..... 2-28  
Safety chains ..... 8-4  
Safety decals ..... 2-4  
Safety equipment ..... 7-1, 10-19  
Safety guidelines ..... 2-2  
Safety standards ..... 1-3  
Salt water ..... 10-6  
Saltwater corrosion ..... 10-6  
Sea Tow Services International, Inc. .... 1-6  
Seals in the engine lower unit ..... 3-6  
Security zones ..... 3-4  
Severe weather ..... 5-1  
Shallow water ..... 5-3  
Shallow water boat stability ..... 3-7  
Shallow water operation ..... 5-3  
Shift and throttle controls ..... 9-16  
Shifting ..... 7-14, 9-17, 9-18  
Shock ..... 5-2  
Signs ..... 6-15  
Single-lever controls ..... 9-16



- Situational awareness .....2-29  
 Small boats and swimmers .....2-29  
 Smoke detector .....9-33  
 Special markers .....6-12  
 Special needs passengers .....2-30  
 Speed .....3-7  
 Speed limits .....3-7  
 Speedometer .....9-28  
 Spillways .....5-3  
 Spotter .....2-36  
 Stabilizer .....9-24  
 Starting .....7-9  
 Static electricity and the fuel  
 system .....7-6  
 Steering .....7-10  
 Stopping .....7-13  
 Storing .....11-1  
 Storm conditions .....5-1  
 Storm warning .....5-4  
 Surge brakes .....8-5  
 Switches .....9-33  
 Symbols .....9-51  
 Synchronizing GPS datum with  
 chart datum .....7-2
- T**
- Tachometer .....9-28  
 Teak .....10-15  
 Testing GFCI receptacles .....9-15  
 The general prudential rule .....6-2  
 Throttle .....9-16  
 Throttle controls .....9-16  
 Thru-hull fittings .....11-1  
 Towing a tender .....2-32  
 Towing hitch .....8-2  
 Towing on the water .....4-7  
 Towing vehicle .....8-2  
 Trailer .....8-1, 10-20  
 Trailer brakes .....8-5  
 Trailer classification .....8-1  
 Trailer regulations .....8-1  
 Trailer type .....8-1  
 Trailering guidelines .....8-6  
 Trim tabs .....7-16, 10-16  
 Twin-engine steering .....7-12
- Type B fire extinguishers .....2-13  
 Typical digital switching  
 controls .....9-25
- U**
- U.S. Coast Guard (USCG) .... 1-7, 3-1  
 U.S. Coast Guard Auxiliary .....1-7  
 U.S. Coast Guard Navigation  
 Center (NAVCEN) .....1-7  
 U.S. Coast Guard Office of  
 Boating Safety .....1-7  
 U.S. Coast Guard's America's  
 Waterway Watch Program .....1-7  
 U.S. Government Printing  
 Office .....1-7  
 U.S. Power Squadrons .....1-7  
 Unapproved lighting .....2-20  
 United States Aids to  
 Navigation System (USATONS) ...6-7  
 Upholstery .....10-12  
 Upper deck capacity limit .....1-5  
 USCG safety standards .....1-3
- V**
- Vegetation .....5-3  
 Very high frequency (VHF)  
 radio .....2-23  
 VHF-DSC radio .....2-25  
 Vinyl cleaner .....10-12  
 Visibility .....5-2  
 Visual distress signaling  
 devices .....2-11  
 Visual distress signals (VDS) .....2-18  
 Voltmeter .....9-30
- W**
- Wake .....3-6  
 Washing .....10-12  
 Waste .....9-38  
 Waste management plan  
 (WMP) .....3-8  
 Water depth gauge .....9-32  
 Water hazards .....5-2  
 Water sports .....2-33  
 Water sports guidelines .....2-34  
 Weather .....4-6



SECTION  
**I**

**INDEX**

Whistle ..... 6-3  
Windlass ..... 7-25  
Window channels ..... 10-14  
Windshield ..... 10-14  
Winterization and storage  
    Winterizing ..... 11-1







# WARRANTY

## RINKER BOATS LIMITED WARRANTY

### MANUFACTURED BY RINKER BOAT COMPANY, LLC A DIVISION OF HIGHWATER MARINE, LLC

**1. WHO WARRANTS THE WARRANTY.** Rinker Boat Company, LLC (“Rinker”) provides the following warranties as set forth in this Limited Warranty to each boat manufactured by Rinker.

**2. WHO IS COVERED AND WHAT IS COVERED.** Rinker warrants to the first consumer-owner (“Buyer”), that the boats it manufactures will be free from substantial defects in materials and workmanship under normal, private use. Any product used for commercial purposes, including but not limited to rental fleets, demonstrators, and competitive racing are not covered by this limited warranty. The following items are covered by this limited warranty for the Buyer:

- **Limited Lifetime Structural Hull Warranty:** Subject to the limitations and exclusions set forth below, Rinker warrants to the Buyer, for as long as the Buyer owns the boat, the hull and structural components of the boat shall be free from substantial defects in materials or workmanship and fit for normal use under normal operating conditions. For purposes of this warranty, the term “hull” is defined as the single fiberglass molded shell and integral fiberglass structural components which are below the hull flange.
- **Five Year Limited Warranty:** Subject to the limitations and exclusions set forth below, for the remaining parts and components that are not covered by the Limited Lifetime Structural Hull Warranty or another manufacturer's warranty, Rinker warrants to the Buyer, for a period of five (5) years from the date of purchase that the parts and materials shall be free from substantial defects in materials or workmanship and fit for normal use under normal operating conditions.

Under both the Limited Lifetime Structural Hull Warranty and the Five Year Limited Warranty, Rinker will repair or replace nonconformities or defects under this Limited Warranty within a reasonable time. Replacement parts provided under terms of the warranty will, at the discretion of Rinker, match original equipment, but no guarantee is made as to the ability to do so. When necessary, Rinker will substitute parts of comparable function or value. Rinker will not be responsible for any sums exceeding the cost of defective part or product. There is no other warranty provided by Rinker other than the Limited Warranty set forth herein.





SECTION  
**W**

## WARRANTY

- 3. TRANSFERABILITY.** The Limited Lifetime Structural Hull Warranty is transferable once if the Buyer sells the boat within five years of the date of purchase. In the event the Buyer sells the boat within five years of the date of Purchase, the Limited Lifetime Warranty shall be limited to a period of five years beginning on the date the Buyer originally purchased the boat. Five Year Limited Warranty is transferable one time to the Second Owner. Completion of a warranty transfer is required through an authorized Rinker dealer.
- 4. OTHER WARRANTIES THAT MAY APPLY.** Additional component warranties may be provided by the respective manufacturers directly and not by Rinker. Applicable warranties may be found in the product owner's packet or by contacting Rinker's Customer Service Department. Rinker will not pay for or honor any such warranty of these separate manufacturers.
- 5. OWNER'S RESPONSIBILITY.** The original owner is required to register this product within fifteen (15) days of delivery of the boat by mail or through an authorized Rinker Sales Center. Owner must provide proof of purchase, including date of purchase, name of retailing dealer, boat serial number, and current proof of ownership at time of warranty claim. Proper maintenance and cleaning of the Rinker products and components are the responsibility of the owner. Failure of any product or component caused by improper cleaning procedures, negligence, neglect, or faulty maintenance procedures is expressly excluded from the warranty. Proper boat registration in compliance with state and federal regulations and the purchase of insurance is the responsibility of the owner.
- 6. HOW TO GET LIMITED WARRANTY SERVICE.** To obtain warranty service, take your boat to the marine dealer where you originally purchased your product, or other authorized Rinker dealer, or another warranty service facility designated by Rinker, and have a warranty claim submitted to Rinker. If you or your dealer has moved, or if your dealer is no longer in business, contact Rinker Customer Service, 300 West Chicago Street, Syracuse, Indiana 46567, for the name of your nearest Rinker dealer. Your claim must be made within thirty (30) days of the discovery of the defect. Based on the determination of Rinker, and subject to the terms of the warranty, the warranty repair work will be authorized by Rinker. Buyer (and Second Owner to the extent applicable under the terms of this Limited Warranty), are responsible for paying any service or repair that is not deemed to be covered by this Limited Warranty.
- 7. WHO PERFORMS LIMITED WARRANTY SERVICE.** The best place to obtain warranty service is at the Rinker dealer where you originally purchased your product. If the dealer cannot perform the service work they should call Rinker Customer Service for assistance. If you are unable to visit your original marine dealer, contact Rinker Customer Service, 300 West Chicago Street, Syracuse, Indiana 46567, for the name and location of a Rinker dealer near you.
- In some instances, Rinker may require that the boat or certain parts be returned to the Rinker manufacturing facility for warranty service. Costs**



**incurred for transporting the boat or parts to and from Rinker are the responsibilities of the owner.**

**8. MODIFICATIONS OF PRODUCTS.** Rinker reserves the right to make changes in design of its products, and changes or improvements to its products, at any time, including during a product year, without imposing any obligation upon Rinker to alter any of its products that were previously manufactured.

**9. EXCLUSIONS.** This warranty expressly excludes coverage of:

- Any boat, including its components, that has been altered or modified so as to adversely affect its operation, performance, or durability.
- Engines, generators, gyroscopic stabilizers, controls, appliances, steering assemblies, outdrives, and other equipment or accessories that are warranted by manufacturers other than Rinker.
- Cosmetic issues including finished surfaces on mirrors, window glass, varnishes, paints, fabrics, chromium plated and stainless steel finishes, and gel-coat issues including swirling, cracking, and osmotic blistering.
- Any boat that has been misused, used in a negligent manner, used for racing, used for rental, charter, or military or other commercial purposes, used without normal maintenance, improper lifting or trailering, neglected, operated contrary to any instruction furnished by Rinker, or operated in violation of any Federal, State, Coast Guard or other governmental agency laws, rules or regulations.
- Any representation relating to speed, range, fuel consumption or other estimated performance characteristic.
- Loss of time, inconvenience, boat payments, retail charges, travel expense, loss of use, in-and-out of water charges, towing and storage charges, loss of damage to personal property, or other remedies not specifically allowed.
- Leakage around the windshield, hardtop, canvas, hatches or other designed opening, rails and hardware.
- Fit and adjustments for exterior canvas tops, enclosures, and weather covers.
- Sacrificial deterioration of anti-fouling paint or zinc anodes.
- Damage resulting from electrolysis or corrosion of any nature from any course.
- Damage due to transporting the boat without removing the hardtop or canvas as necessary.
- Any transportation charges to and from the dealer, including transportation to and from the factory if it is deemed necessary.
- Any upholstery damage, including but not limited to tears, punctures, fading, or soiling.



## **Rinker Boat Company**

300 W Chicago Street, Syracuse, IN 46567

[rinkerboats.com](http://rinkerboats.com)





- Any boat outpowered according to the U.S. Coast Guard recommended engine, horsepower capacity plate.
- Damage caused by water in the bilge (whether it be fresh water or salt water), including any damage done to fly wheels, ring gears, starters, oil pans, electrical components, and the engine.
- Expenses associated with routine maintenance items or any condition resulting from neglect, improper or prolonged storage, or the failure to perform routine maintenance as required.
- Scratches, dents, or other surface blemishes.
- Damage caused by continued use of the boat after a defect is or should have been discovered.
- Water damage of any nature, mold, mildew, or dry rot to interior surfaces, wood structures, upholstery, or polyurethane foam.
- Perceived diminution in value due to normal moisture levels in stringers and transoms.
- Accessories, components, machinery, or equipment that is not installed by Rinker at its factory, including any damage done as a result of the addition of such accessories, components, machinery, or equipment.

**10. DISCLAIMERS AND LIMITS OF THE WARRANTY.** This written statement of limited warranty represents the entire warranty authorized and offered by Rinker which, pursuant to the terms of this limited warranty, is limited to repair or replacement of defective parts or equipment at the option of Rinker. This warranty cannot be amended by any dealership, salesperson, or agent. **THIS WARRANTY IS IN LIEU OF ALL OTHER WARRANTIES, WHETHER EXPRESS OR IMPLIED, STATUTORY OR OTHERWISE. TO THE GREATEST EXTENT PERMITTED BY LAW, THERE IS NO WARRANTY OF MERCHANTABILITY OR FITNESS FOR A PARTICULAR PURPOSE OR USE. THE REPAIR OR REPLACEMENT HEREIN IS THE SOLE AND EXCLUSIVE REMEDY. RINKER SHALL NOT BE LIABLE TO THE ORIGINAL OWNER, OR ANYONE ELSE, FOR CONSEQUENTIAL, INCIDENTAL, SPECIAL, EXEMPLARY, INDIRECT, OR PUNITIVE DAMAGES, INCLUDING WITHOUT LIMITATION, PERSONAL INJURY, DEATH, PROPERTY DAMAGE, LOST PROFITS, LABOR COSTS, PENALTIES, LOST SALES, LOSS OF TIME, LOSS OF USE OR ENJOYMENT, TOWING EXPENSES, HAUL OUT OR LAUNCHING EXPENSES, DE-RIGGING OR RE-RIGGING CHARGES, GASOLINE, MILEAGE, BOAT PAYMENTS, INTEREST, STORAGE AND SLIP FEES, INSURANCE, POSTAGE, AFTERMARKET GOODS, DEPRECIATION OF VALUE DUE TO AGE OR REPAIRS CONDUCTED OR NEEDED, COURT COSTS AND EXPENSES, ATTORNEY FEES, OR ANY OTHER PECUNIARY DAMAGE WHETHER DUE TO ANY DEFECT, DELAY, NON DELIVERY, NONPERFORMANCE, RECALL, BREACH BY RINKER, OR ANY ACTS OR OMISSIONS RELATED THERETO, OR WHETHER ASSERTED UNDER WARRANTY, TORT (INCLUDING NEGLIGENCE AND STRICT LIABILITY) OR OTHER THEORY OF LAW OR EQUITY. ALL CLAIMS IN TORT, STRICT**



**LIABILITY, AND FAILURE OF THE ESSENTIAL PURPOSE ARE WAIVED AND EXCLUDED. DAMAGES ARE EXCLUSIVELY LIMITED TO THE COST OF REPAIR AND/OR REPLACEMENT OF THE DAMAGED OR DEFECTIVE PART OR PARTS AT THE OPTION OF RINKER. UNDER NO CIRCUMSTANCES SHALL RINKER'S LIABILITY FOR ANY DEFECT IN THE GOODS, WHETHER BASED ON CONTRACT, TORT, WARRANTY, STRICT LIABILITY, OR ANY OTHER THEORY, EXCEED THE PURCHASE PRICE OF THE DEFECTIVE PART OR PARTS.**

**Some states do not allow one or more of these limitations, so certain of the foregoing limitations may not apply to your specific situation.**

**11. PERIOD OF LIMITATIONS:** No claim, suit, or other proceeding arising out of or related to Rinker's products, services, or this Warranty may be brought after one (1) year from the date it accrues. No discovery, estoppel, or other rule shall apply to extend this limitation period.

**12. CHOICE OF LAW; JURISDICTION AND VENUE.** This warranty shall be governed exclusively by, and construed exclusively in accordance with, the internal laws of the State of Indiana without reference to the choice of law or conflict of law principles thereof, and all claims relating to or arising out of this warranty, or the breach thereof, whether sounding in warranty, contract, tort or otherwise, shall likewise be governed exclusively by the laws of the State of Indiana without reference to the choice of law or conflict of law principles thereof. The United Nations Convention on the International Sale of Goods shall not be used in the interpretation and application of this Warranty. To the extent any action is permitted in a court of competent jurisdiction, the exclusive jurisdiction for such action shall be the state court sitting in Elkhart County, Indiana or in the United States District Court for the Northern District of Indiana, South Bend Division. The parties hereby waive any claim or defense that such forum is not convenient or proper. Each party expressly agrees that any such court shall have *in personam* jurisdiction over it for any such action, and each party consents to service of process in any manner authorized by Indiana law.

**13. STATE and FEDERAL WARRANTY ENFORCEMENT LAWS.** This warranty gives you specific legal rights. You may also have other rights which vary from state to state. Some states may have laws which permit owners to obtain a replacement unit or a refund of the purchase price under certain circumstances. The provisions of these laws vary from state to state. To the extent allowed by state law, Rinker requires that you first provide us with written notification of any service difficulty you have experienced with the Rinker boat so that we have an opportunity to make any needed repairs, before you are eligible for the remedies provided by these laws. Your written notification should be sent to the Rinker Customer Service Manager at the address set out above. Always include your Hull Identification Number (HIN), found on the stern HIN tag of the boat. To the extent any provisions of this limited warranty are inconsistent or deemed unenforceable with (or under) State or Federal laws, only those parts shall be deemed to be voided or limited to the extent required to comply with the law at issue.



## WARRANTY

**14. FEDERAL COMPLIANCE.** The terms of the warrantors undertaking expressed in this limited warranty are drafted to comply with the Magnuson Moss Warranty Legislation, P.L. 93-637 of 1974, and other applicable law.

**15. SEVERABILITY.** If any provision or individual term of this Warranty is invalid or unenforceable under any applicable law, the provision or term shall be ineffective to that extent and for the duration of the illegality, but the remaining provisions and terms shall be unaffected.