



MY19 SNOW APP ACC CAN



CAN | 9930442

MY19 SNOW P66A CATALOG-CAN - 9930442



FIND EVERYTHING YOU'RE LOOKING FOR AT [POLARIS.COM/SHOP](https://www.polaris.com/shop)

UNLESS NOTED, TRADEMARKS ARE THE PROPERTY OF POLARIS INDUSTRIES INC. 3M® Reflective Material, Scotchlite® and Thinsulate® are registered trademarks of 3M Corporation. 509® is a registered trademark of Teton Outfitters, LLC. AMARA® is a registered trademark of Kuraray Co., Ltd. AP-360® is a registered trademark of Stars Design Group, Inc. ArcticFX® is a registered trademark of ArcticXgraphics LLC. BITEHARDER® is a registered trademark of Welch Manufacturing Technologies, Ltd. BDA® is a registered trademark of Boa Technology, Inc. CALIBER® is a registered trademark of Ohara Corporation. Camso is a registered trademark of Arctic Investments S.A. Lycra® and Thermolite® are registered trademarks of INVISTA North America S.A.R.L. Kevlar® is a registered trademark of E.I. du Pont de Nemours and Company. Kolpin® is a registered trademark of Polaris Industries Inc. Loctite® is a registered trademark of Henkel Corporation. Pro Taper® is a registered trademark of Lacey Distribution, Inc. QUICK-DRY® is a registered trademark of Innovative Fashion Group Corp. FOX® is a registered trademark of FOX Racing Shox. GORE-TEX® and GUARANTEED TO KEEP YOU DRY® are registered trademarks of W. L. Gore & Associates, Inc. OGIO® is a registered trademark of Ogio International, Inc. Snobunje® is a registered trademark of Snobunje, Inc. Rox® is a registered trademark of Rox® Speed FX Inc. Taslan® is a registered trademark of Heberlein Maschinenfabrik AG. Snell® is a registered trademark of Snell® Memorial Foundation, Inc. Tekvest® is a registered trademark of Tekrider. Tuflok® is a registered trademark of Illinois Tool Works Inc. Velcro® is a registered trademark of Velcro Industries. B.V. Walker Evans® is a registered trademark of Walker Evans Enterprises Corp. Woody's® and Traction Master® are registered trademarks of International Engineering and Manufacturing, Inc. Bluetooth® is a registered trademark of Bluetooth Sig, Inc. Aquaguard®, Vision® and YKK® are registered trademarks of YKK Corporation. Zylex® is a registered trademark of Genfoot, Inc. All worldwide rights reserved. Other trademarks used in this catalog are owned by their respective owners. Prices, fitment and availabilities are subject to change at any moment. © 2018 Polaris® Industries, Inc.

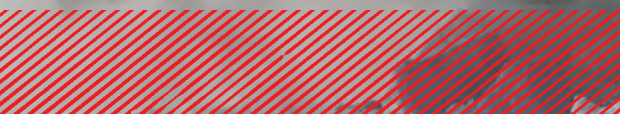

CAN VERSION

# 2019

**APPAREL & ACCESSORIES**

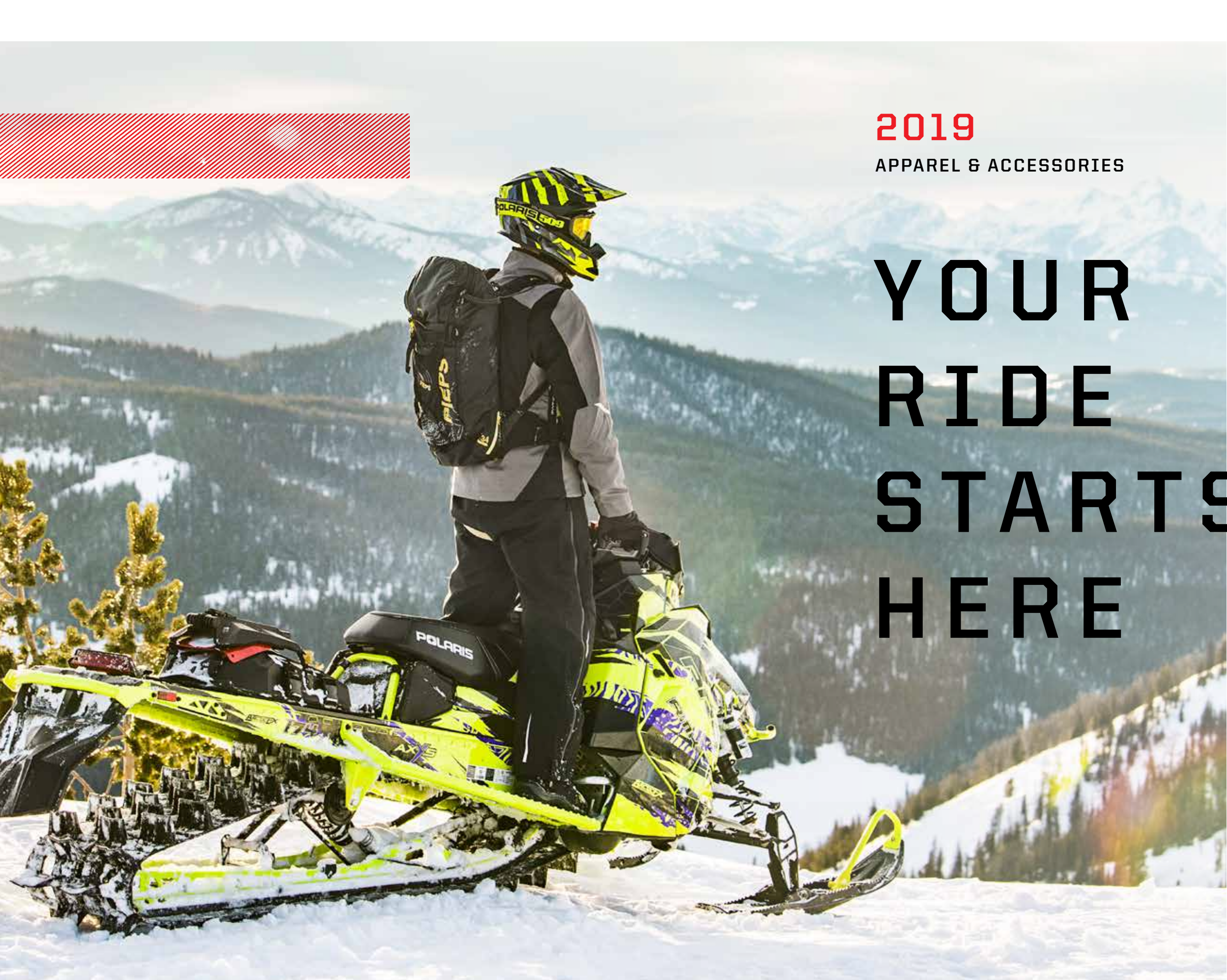

2019

APPAREL & ACCESSORIES

# YOUR RIDE STARTS HERE

## APPAREL

MEN'S UNINSULATED JACKETS	6
MEN'S INSULATED JACKETS	8
MEN'S MONOSUIT	11
MEN'S TECHNICAL WEAR	14
WOMEN'S RIDING GEAR	16
WOMEN'S TECHNICAL WEAR	20
HELMETS	22
GOGGLES	28
GLOVES	30
BOOTS	32
BEANIES	33
MEN'S SPORTSWEAR & CAPS	34
WOMEN'S SPORTSWEAR	38
YOUTH RIDING GEAR	40
YOUTH SPORTSWEAR	41
MERCHANDISE	42
OGIO® BAGS	43

## ACCESSORIES

POLARIS ENGINEERED™	46
STORAGE & RACKS	58
HITCHES	64
SEATING	66
WINDSHIELDS	68
BUMPER	70
RUNNING BOARDS	72
HOODS, PANELS & WRAPS	74
RIDE COMMAND® & P.I.D.D.	76
ELECTRONICS	79
COVERS	80
TRAILERING	81
SKIS & CARBIDES	82
SHOCKS & STUDS	84
TRACKS	86

## GARAGE

BELTS, PARTS & VEHICLE CARE	88
OIL & LUBRICANTS	90
GARAGE & CLEANING	92
GENERATORS	94
TOOL CHESTS	96

Unless noted, trademarks are the property of Polaris® Industries Inc. 3M® Reflective Material, Scotchlite® and Thinsulate® are registered trademarks of 3M Corporation. 505P® is a registered trademark of Teton Outfitters, LLC. AMARA® is a registered trademark of Kuraray Co., Ltd. AP-300® is a registered trademark of Stars Design Group, Inc. ArcticFX™ is a registered trademark of ArcticFXGraphics LLC. BITEHARDER® is a registered trademark of Welch Manufacturing Technologies, Ltd. BOA® is a registered trademark of Boa Technology, Inc. CALIBER® is a registered trademark of Ohara Corporation. Camso is a registered trademark of Artic Investments SA. Lycra® and Thermolite® are registered trademarks of INVISTA North America S.A.R.L. Keivar® is a registered trademark of E.I. du Pont de Nemours and Company. Kalpin® is a registered trademark of Polaris Industries Inc. Locitite®, is a registered trademark of Henkel Corporation. Pro Taper® is a registered trademark of Lucy Distribution, Inc. QWICK-DIP® is a registered trademark of Innovative Fashion Group Corp. FGM® is a registered trademark of FOX Racing Shoes. GORE-TEX® and GUARANTEED TO KEEP YOU DRY® are registered trademarks of W. L. Gore & Associates, Inc. OGIQ® is a registered trademark of Ogilv International, Inc. Snoburn® is a registered trademark of Snoburne, Inc. Row® is a registered trademark of Row® Speed FX Inc. Tachin® is a registered trademark of Heberlein Maschinenfabrik AG. Snel® is a registered trademark of Snel® Memorial Foundation, Inc. Tekwest® is a registered trademark of Tekrider. Tuftek® is a registered trademark of Illinois Tool Works Inc. Velcro® is a registered trademark of Velcro Industries. B.V. Walker Evans® is a registered trademark of Walker Evans Enterprises Corp. Wondy's® and Traction Master® are registered trademarks of International Engineering and Manufacturing, Inc. Bluetooth® is a registered trademark of Bluetooth Sig, Inc. Aquaguard®, Velon® and YKK® are registered trademarks of YKK Corporation. Zylex® is a registered trademark of Genfoot, Inc. All worldwide rights reserved. Other trademarks used in this catalog are owned by their respective owners. Prices, fitment and availabilities are subject to change at any moment. © 2018 Polaris® Industries, Inc.

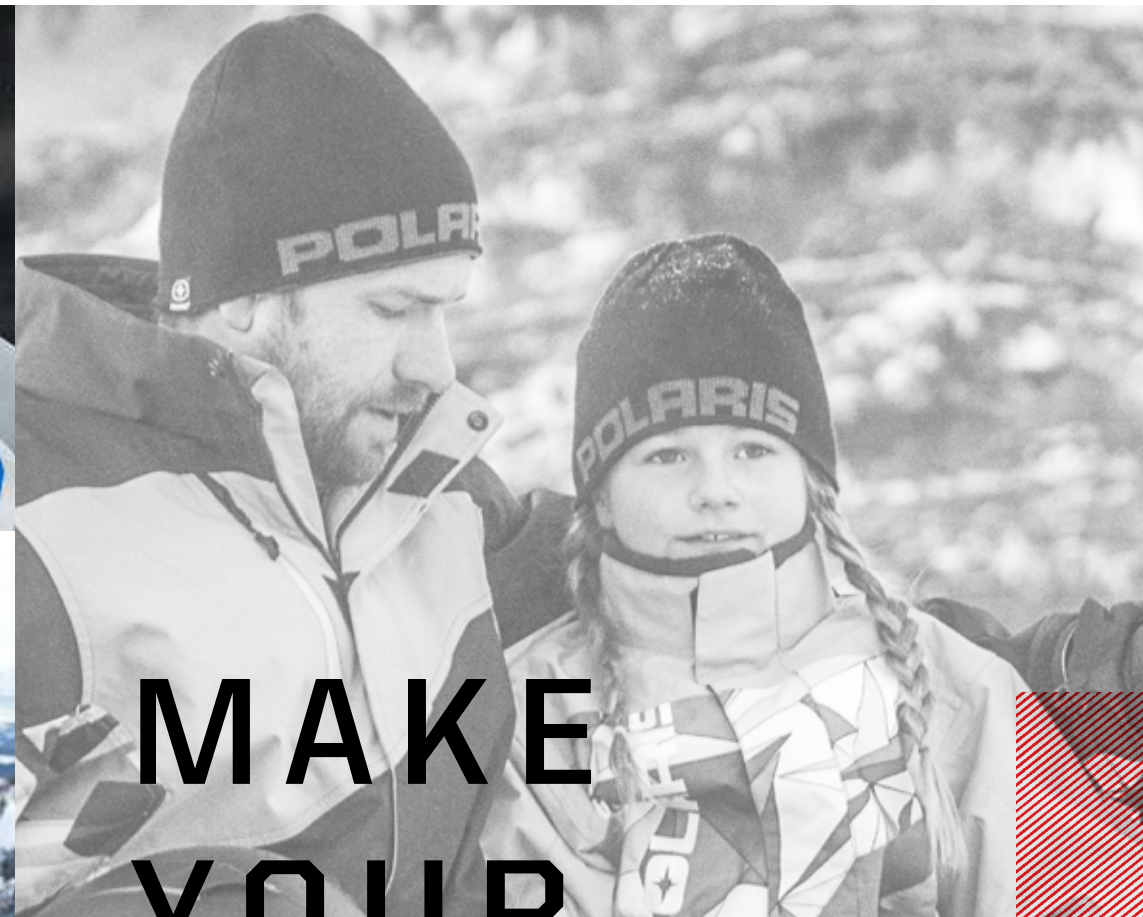

# MAKE YOUR MOMENT

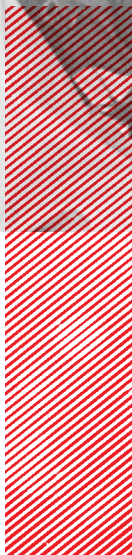

Out here is where we come alive, and come together. It's more than a sport, it's a way of life. Polaris® gear adds comfort, warmth, personal style, and longevity to your riding experience. When you choose Polaris, you become part of a proud community that lives for more miles, more connection, and more escape. Together, we're connected by a Polaris legacy built on moments and memories forged one ride at a time. Together, we are **BORN FOR MORE.**

## BUILT BY RIDERS, FOR RIDERS.

Designed with quality materials, engineered to keep you both warm and dry—all tested in real-world environments. We live the lifestyle and pour our experience into each item so you can buy with confidence knowing that warmth, comfort, mobility, and endurance are dialed in.

### 509 FOR POLARIS

#### REMAIN GUARDED

A trusted name in helmet and goggle manufacturing, 509® helmets utilize advanced materials like carbon fiber for lightweight protection.

#### DWR RESIST MOISTURE

All outerwear garments are treated with superior Durable Water Repellency (DWR) to prevent any precipitation from saturating the outer fabric. The DWR causes the water to bead up and run off helping to keep you dry. Tested up to 50 washes.

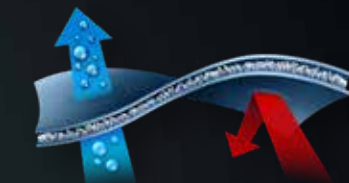

### 3M Thinsulate INSULATION

#### BE WARMER

3M® Thinsulate® Insulation is the gold standard in high-tech microfiber warmth, working to deflect and diffuse cold air before it reaches your body.

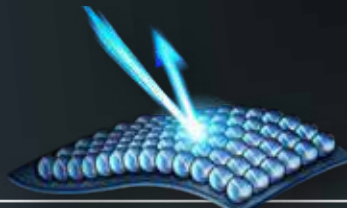

### 3M Scotchlite™ Reflective Material

#### RIDE SAFER

Proven in every weather condition, patented 3M® Scotchlite™ Reflective Material radiantly bounces light back at its source so you'll always be seen.

#### GORE-TEX STAY DRIER

Trusted around the globe by millions, Gore-Tex® fabric is guaranteed to keep you dry\* by deflecting moisture and wind without compromising breathability.



#### YKK ZIPPERS LAST LONGER

The most trusted name in the industry. Quality construction that doesn't fail.



POLARIS ENGINEERED APPAREL™  
**3 YEAR**  
 FACTORY WARRANTY



CUSTOMIZE YOUR CLIMATE

## LAYERING 101

Make sure the ride remains an enjoyable experience by staying warm and dry out in the elements. Polaris® brand outerwear is part of a smart solution that integrates multiple layers for ultimate performance. Create your own environment by mixing outer layers, insulating mid-layers, and base layers. Finding the right combination for you is essential to being comfortable, allowing for adjustment as the weather conditions change.



BASE

Helps regulate your overall temperature by wicking away moisture.



INSULATING

Works to pull moisture away while keeping body heat near the skin.



OUTER

Regulates your body temp by venting moisture and blocking out wind, snow, and water.

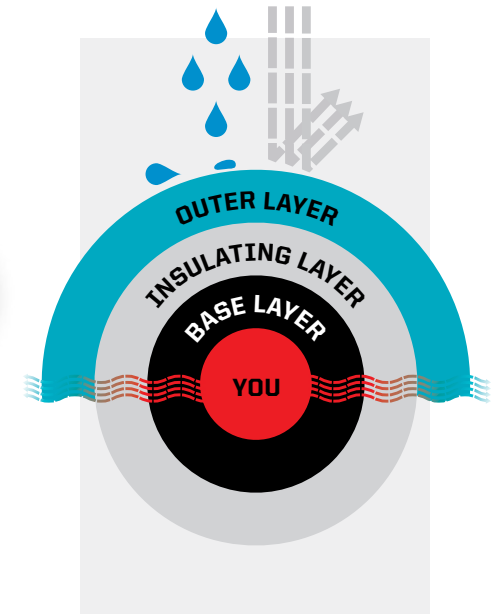

## SIZING GUIDE

### MEN'S JACKET & BIB SIZING

Size:	S	M	L	XL	2XL	3XL	4XL	5XL	MT	LT	XLT	2XLT
Chest:	34-36	38-40	42-44	46-48	50-52	54-56	58-60	62-64	38-40	42-44	46-48	50-52
Sleeve*:	33-35	33-35	34-35	34-35	34-35	34-35	34-35	34-35	33-35	34-35	34-35	34-35
Waist:	31-33	35-37	39-41	43-45	47-49	51-53	55-57	59-61	35-37	39-41	43-45	47-49
Hips/Seat:	34-36	38-40	42-44	46-48	50-52	54-56	58-60	62-64	38-40	42-44	46-48	50-52
Inseam:	30-35	30-35	30-35	30-35	30-35	30-35	30-35	30-35	36-37	36-37	36-37	36-37

### WOMEN'S JACKET & BIB SIZING

Size:	S	M	L	XL	2XL	3XL
Chest:	32-34	35-38	39-42	43-46	47-50	51-54
Sleeve*:	29-30	31-33	31-33	31-33	31-33	31-33
Waist:	26-28	29-32	33-36	37-40	41-44	45-48
Hips/Seat:	35-37	38-41	42-45	46-49	50-53	54-57
Inseam:	26-29	27-30	27-30	27-30	27-30	27-30

\* Measure sleeve length from center back neck. Youth apparel sizing on page 41, helmet sizing on page 23.

# MEN'S RIDING GEAR



★ TOP SELLER

TWO-WAY ZIPS FOR VENTING UNDER THE ARMS WITH MESH LINER

**BLACK/LIME**  
 Sizes: S-3XL  
 2868501



## PRO JACKET

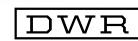

ADVANCED, UNINSULATED GORE-TEX® JACKET FOR OUR MOST ACTIVE RIDERS

### SHELL

- Durable 600D polyester outer fabric resists snagging and pilling
- Gore-Tex® membrane is 100% waterproof, windproof, and breathable—guaranteed to keep you dry
- Superior DWR prevents precipitation from saturating the jacket's exterior

### FEATURES

- Articulated elbows and action back deliver excellent mobility and reduced rider fatigue
- Storm flap, wrist and waist gaiters, and two-way adjustable pit venting
- 3M® Scotchlite® Reflective Material for nighttime visibility

### WARMTH



### BREATHABILITY



### VERSATILITY



**\$454.99**



**BLACK/ORANGE**  
 Sizes: S-3XL  
 2867701

**BLACK/RED**  
 Sizes: S-3XL, MT-2XLT  
 2867702

**GRAY/BLUE**  
 Sizes: S-3XL  
 2867703



**ACTION BACK**  
 GIVES A LARGE RANGE OF MOTION



**GRAY/RED**  
 Sizes: S-3XL  
 2867713



## ADVENTURE JACKET



OUR WARMEST GORE-TEX® JACKET; PERFECT FOR YOUR COLDEST RIDING DAYS

### SHELL

- Durable 600D polyester outer fabric resists snagging and pilling
- Gore-Tex® membrane is waterproof, windproof, and breathable—guaranteed to keep you dry
- Superior DWR prevents precipitation from saturating the jacket's exterior

### LINING

- Built-in zonal 3M® Thinsulate® Insulation—280 grams in body and 180 grams in arms

### FEATURES

- Articulated elbows and action back deliver excellent mobility and reduced rider fatigue
- Two-way adjustable pit and back venting with mesh insert
- Wrist and waist gaiters to keep snow and cold out
- 3M® Scotchlite® Reflective Material for nighttime visibility

### WARMTH



### BREATHABILITY



### VERSATILITY



**\$494.99**



**GRAY/ORANGE**  
 Sizes: S-3XL, MT-2XLT  
 2867712

**BLACK/GRAY**  
 Sizes: S-3XL, MT-2XLT  
 2867711



**GORE-TEX®**  
 with waterproof guarantee



**CROSSOVER**

## THROTTLE JACKET

**DWR** **3M Thinsulate INSULATION** **3M Scotchlite Reflective Material** **YKK ZIPPERS**

**BLUE**  
 Sizes: S-3XL  
 2869912

3-IN-1 DESIGN FOR MAXIMUM ADAPTABILITY IN ALL CONDITIONS

**SHELL**

- Durable 600D polyester outer fabric resists snagging and pilling
- Superior DWR prevents precipitation from saturating the jacket's exterior

**LINING**

- Removable liner with zonal 3M® Thinsulate® Insulation—180 grams in main body, 100 grams in sleeves

**FEATURES**

- Articulated elbows and action back deliver excellent mobility and reduced rider fatigue
- Two-way adjustable pit and back venting with mesh insert, plus wrist and waist gaiters to keep snow and cold out
- 3M® Scotchlite® Reflective Material for nighttime visibility

**WARMTH**



**BREATHABILITY**



**VERSATILITY**



LAYER: 3-IN-1

**\$369<sup>99</sup>**



**AMERICANA**  
 Sizes: S-3XL, MT-2XLT  
 2869911

**BLACK/GRAY**  
 Sizes: S-3XL  
 2867714

**BLACK/LIME**  
 Sizes: S-3XL  
 2868503

**3-IN-1 LAYERING SYSTEM**

**REMOVABLE 3M® THINSULATE® LINER** can be worn independently for complete versatility



**TRAIL**

## RIPPER JACKET

**DWR** **3M Thinsulate INSULATION** **3M Scotchlite Reflective Material** **YKK ZIPPERS**

**LIME**  
 Sizes: XS-3XL, MT-2XLT  
 2869908

RUGGED DESIGN DELIVERS WARMTH AND STYLE

**SHELL**

- Durable 600D polyester outer fabric resists snagging and pilling
- Superior DWR prevents precipitation from saturating the jacket's exterior

**LINING**

- Built-in zonal 3M® Thinsulate® Insulation—180 grams in body and 100 grams in arms

**FEATURES**

- Two-way adjustable pit venting with mesh insert
- Storm flap and wrist/waist gaiters keep out snow and cold
- 3M® Scotchlite® Reflective Material for nighttime visibility

**WARMTH**



**BREATHABILITY**



**VERSATILITY**



LAYER: OUTER

**\$259<sup>99</sup>**



**BLUE**  
 Sizes: XS-3XL  
 2869909

**BLACK/ORANGE**  
 Sizes: XS-3XL, MT-2XLT  
 2868504

**BLACK/RED**  
 Sizes: XS-3XL, MT-2XLT  
 2867718



Superior Durable Water Repellency (DWR) prevents precipitation from saturating the jacket's exterior.



DRIFTER PANTS (P. 13)



## DRIFTER JACKET

AFFORDABLE COLD WEATHER PERFORMANCE AND STYLE

### SHELL

- Durable 300D polyester outer fabric resists snagging and pilling
- Superior DWR prevents precipitation from saturating the jacket's exterior

### LINING

- Built-in, zonal 3M<sup>®</sup> Thinsulate<sup>®</sup> Insulation—180 grams for excellent warmth

### FEATURES

- Two hand pockets and MP3 port
- Wrist and waist gaiters seal out snow and cold to keep you warm
- 3M<sup>®</sup> Scotchlite<sup>®</sup> Reflective Material for nighttime visibility

### WARMTH



### BREATHABILITY



### VERSATILITY



\$194<sup>99</sup>



BLUE/ORANGE

Sizes: S-3XL  
2869913



BLUE  
Sizes: S-3XL  
2868533



RED  
Sizes: S-3XL  
2868535

## MEN'S MONOSUIT



ONE-PIECE DELIVERS FULL RANGE OF MOTION AND KEEPS THE SNOW OUT

### SHELL

- Durable 600D polyester outer fabric resists snagging and pilling
- Superior DWR prevents precipitation from saturating the jacket's exterior

### FEATURES

- One-piece construction ensures powder stays on the outside
- Provides room for a mid-layer for added warmth against the cold
- Features venting in several locations for dumping heat as needed
- Adjustable waist and cuffs, leg and wrist gaiters, and integrated suspenders

### WARMTH



### BREATHABILITY



### VERSATILITY



LAYER:  
OUTER



\$589<sup>99</sup>

### ACTION BACK

Hidden stretch panels located near outer shoulder allow for ample movement during active riding.



### INTEGRATED SUSPENDERS

The waist fits snugly to the body, thanks to adjustable waist cuffs.



### FULL-LEG YKK<sup>®</sup> ZIPPERS

Full-leg YKK<sup>®</sup> zipper construction allows for easy on and off. Also, it helps with venting when off the sled.



UNINSULATED



BLUE/LIME  
Sizes: S-3XL  
2868525

BLACK/RED  
Sizes: S-3XL  
2868524

FOR LAYERING EDUCATION SEE P. 5

MEN'S JACKETS & MONOSUIT



**BLACK**  
 Sizes: S-3XL, MT-2XLT  
 2867708

★ TOP SELLER

ARTICULATED KNEES WITH REMOVABLE EVA FOAM KNEE PADS

ANKLE GAITERS KEEP SNOW AND WIND OUT

**MOUNTAIN**  
**PRO BIB**  
 UNINSULATED



**TOP-OF-THE-LINE GORE-TEX® BIB FOR EXTREME PERFORMANCE AND COMFORT**

**SHELL**

- Durable 6000 polyester outer fabric resists snagging and pilling
- Gore-Tex® membrane is waterproof, windproof, and breathable - guaranteed to keep you dry
- Superior DWR prevents precipitation from saturating the bib's exterior

**FEATURES**

- Stretch side panels and adjustable shoulder straps guarantee a comfortable fit
- 3M® Scotchlite® Reflective Material for nighttime safety
- Long-lasting YKK® zippers, including full-length zippers on legs

**WARMTH**

**BREATHABILITY**

**VERSATILITY**

**\$454.99**



**BLACK**  
 Sizes: S-3XL, MT-2XLT  
 2867725

**TRAIL**  
**ADVENTURE BIB**  
 INSULATED



**WATERPROOF GORE-TEX® BIB IS GUARANTEED TO KEEP YOU DRY®**

**SHELL**

- Durable 6000 polyester outer fabric resists snagging and pilling
- Gore-Tex® membrane is waterproof, windproof, and breathable - guaranteed to keep you dry
- Superior DWR prevents precipitation from saturating the bib's exterior

**LINING**

- Zonal 3M® Thinsulate® Insulation~180 grams in the front legs and 100 grams in the seat

**FEATURES**

- Stretch side panels and adjustable shoulder straps guarantee a comfortable fit
- Rugged, two-way YKK® zippers run full-length for easy-on and easy-off performance
- Lower ankle gaiters keep snow out and a retention strap keeps gaiters from riding up
- 3M® Scotchlite® Reflective Material for nighttime visibility

**WARMTH**

**BREATHABILITY**

**VERSATILITY**

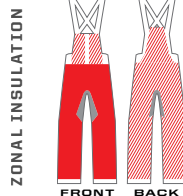

**\$479.99**



**BLACK**  
 Sizes: S-3XL, MT-2XLT  
 2867727

★ TOP SELLER

ZIP FROM BIBS TO PANTS IN SECONDS

**TRAIL**  
**RIPPER BIB**  
 INSULATED



**COMPLETE VERSATILITY WITH ZIP-OFF DESIGN THAT CONVERTS BIB TO PANT**

**SHELL**

- Durable 6000 polyester outer fabric resists snagging and pilling
- Superior DWR prevents precipitation from saturating the bib's exterior

**LINING**

- Zonal 3M® Thinsulate® Insulation~180 grams in the front legs and 100 grams in the seat

**FEATURES**

- Zip-off bib design allows them to be worn as pants or bibs
- Rugged, two-way YKK® zippers run full-length for easy-on and easy-off performance
- Stretch side panels for comfort and two zipper hand pockets
- Lower ankle gaiters keep snow out and a retention strap keeps gaiters from riding up
- 3M® Scotchlite® Reflective Material for nighttime visibility

**WARMTH**

**BREATHABILITY**

**VERSATILITY**

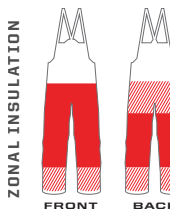

**\$259.99**



**BLUE/ORANGE**  
 Sizes: S-3XL  
 2869922

NEW

**TRAIL**  
**DRIFTER PANT**  
 INSULATED



**AFFORDABLE COLD WEATHER PERFORMANCE**

**SHELL**

- Durable 3000 polyester outer fabric resists snagging and pilling
- Superior DWR prevents precipitation from saturating the pants' exterior

**LINING**

- Zonal 3M® Thinsulate® Insulation~180 grams in the front legs and 100 grams in the seat

**FEATURES**

- Integrated leg gaiters seal out cold and snow
- Belt loops come standard

**WARMTH**

**BREATHABILITY**

**VERSATILITY**

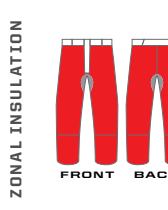

**\$194.99**

ZONAL INSULATION GUIDE: LEAST INSULATION MOST INSULATION



**NEW**  
**HEATED VEST**

COMFORT WITH THE TOUCH OF A BUTTON

- Three heat settings that help you adjust to changing weather conditions
- Down-proof material with 160 grams of insulation
- Powered by a small rechargeable battery (included)
- Battery can be recharged via USB or any 12V outlet (for sled outlet, PN 2878475)
- Charge a cell phone with the rechargeable battery
- Machine washable
- Perfect for any outdoor activity

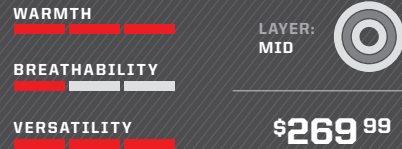

STAY WARM AND CHARGE YOUR CELL PHONE WHILE YOU RIDE

**DARK GRAY** **NEW**  
Sizes: S-3XL | 2869924

**BLUE/ORANGE**  
Sizes: S-3XL | 2869919



**SOFTSHELL JACKET**

CASUAL JACKET ARMED WITH RUGGED AND WARM FEATURES FOR EVERYDAY WEAR

- Superior DWR prevents precipitation from saturating the jacket's exterior
- Lined with 280 grams of soft fleece for warmth
- Removable hood, underarm venting, three external pockets, and one internal chest pocket



**BLACK**  
Sizes: S-3XL | 2869918



**GRAY** **NEW**  
S-3XL | 2869536

**BLACK** **NEW**  
S-3XL | 2869535

**TECH QUARTER-ZIP**

EXCELLENT FOR LAYERING OR AS A CASUAL, COMFORTABLE, STYLISH SHIRT

- High-performance garment is ideal as a mid-layer riding or standalone
- Four-way stretch material is breathable and moisture-wicking to keep you warm and dry
- Cut and sewn for a contoured fit

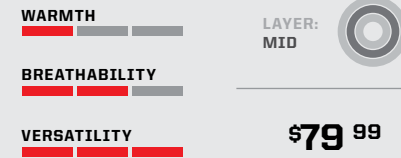

**GRAY** **NEW**  
S-3XL | 2869925

**TRAIL MID-LAYER**

LAYER FOR VERSATILITY AND WARMTH WITH THIS BREATHABLE FLEECE MID-LAYER

- Extra layer of warmth for when you need it
- 280 grams of breathable fleece and a wear-resistant polyester face
- Designed to fit under outer shell when riding
- Extra layer across chest to block wind without restricting movement

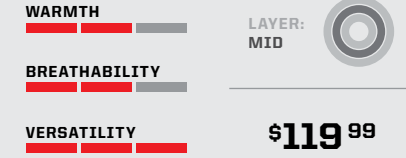

**GRAY/LIME**  
Sizes: S-3XL | 2868513

**BLACK/GRAY**  
Sizes: S-3XL | 2868512

**MID-LAYER**

LAYER FOR VERSATILITY AND WARMTH WITH THIS BREATHABLE FLEECE MID-LAYER

- Extra layer of warmth which you can add or subtract depending upon activity and temperature
- 280 grams of breathable fleece and a wear-resistant polyester face
- Designed to fit under outer shell when riding



**LIGHTWEIGHT BASE LAYER**

FOR MAXIMUM BREATHABILITY, PERFECT FOR ACTIVE RIDERS

- Breathable, moisture-wicking poly/spandex fabric
- Four-way stretch
- Best for warm days

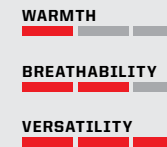

TOP | Sizes: S-3XL | 2867787

BOTTOM | Sizes: S-3XL | 2867788



**MIDWEIGHT BASE LAYER**

ADD MORE INSULATION WHEN THE WEATHER TAKES A COLDER TURN

- Very warm; best for extreme cold
- 92% polyester, 8% spandex
- Breathable, moisture-wicking poly/spandex fabric

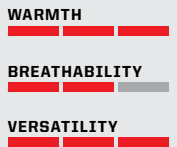

TOP | Sizes: S-3XL | 2866007

BOTTOM | Sizes: S-3XL | 2866006

# WOMEN'S RIDING GEAR



CROSSOVER

**BLACK/BLUE**  
 Sizes: S-3XL  
 2868541

**GORE-TEX** **DWR** **3M Thinsulate INSULATION** **3M Scotchlite Reflective Material** **YKK ZIPPERS**

## DIAMOND JACKET

OUR MOST ADVANCED AND VERSATILE GORE-TEX® JACKET FOR DEMANDING RIDERS

**SHELL**

- Durable 300D polyester outer fabric resists snagging and pilling
- Gore-Tex® membrane is waterproof, windproof, and breathable—guaranteed to keep you dry\*
- Superior DWR prevents precipitation from saturating the jacket's exterior

**LINING**

- Removable liner with zonal 3M® Thinsulate® Insulation—100 grams in main body and 60 grams in sleeves

**FEATURES**

- Two-way adjustable pit venting with mesh inserts
- Back vents with mesh inserts
- Two hand and one chest pocket; two internal pockets in shell
- 3M® Scotchlite® Reflective Material for nighttime visibility

**WARMTH**  
 [Progress bar]

**BREATHABILITY**  
 [Progress bar]

**VERSATILITY**  
 [Progress bar]

LAYER: 3-IN-1 [Icon]

**\$479<sup>99</sup>**



**GRAY/PINK**  
 Sizes: S-3XL  
 2868540

**3-IN-1 LAYERING SYSTEM**

**REMOVABLE 3M® THINSULATE® LINER** can be worn independently for complete versatility



CROSSOVER

**FUSCHIA**  
 Sizes: S-3XL  
 2869917

**DWR** **3M Thinsulate INSULATION** **3M Scotchlite Reflective Material** **YKK ZIPPERS**

## THROTTLE JACKET

VERSATILE JACKET WITH 3-IN-1 DESIGN FOR WARMTH AND COMFORT

**SHELL**

- Durable 300D polyester outer fabric resists snagging and pilling
- Superior DWR prevents precipitation from saturating the jacket's exterior

**LINING**

- Removable liner with zonal 3M® Thinsulate® Insulation—180 grams in main body, 100 grams in sleeves

**FEATURES**

- Two-way adjustable pit venting with mesh inserts
- Two external and two internal pockets in shell
- 3M® Scotchlite® Reflective Material for nighttime visibility

**WARMTH**  
 [Progress bar]

**BREATHABILITY**  
 [Progress bar]

**VERSATILITY**  
 [Progress bar]

LAYER: 3-IN-1 [Icon]

**\$369<sup>99</sup>**



**BLUE**  
 Sizes: S-3XL  
 2869916

**BLACK/GRAY**  
 Sizes: S-3XL  
 2868506



Superior Durable Water Repellency (DWR) prevents precipitation from saturating the jacket's exterior.



TRAIL

## DIVA JACKET

DELIVERS WARMTH, COMFORT, AND STYLE ON AND OFF THE SLED

### SHELL

- Durable 300D polyester outer fabric resists snagging and pilling
- Superior DWR prevents precipitation from saturating the jacket's exterior

### LINING

- Built-in, zonal 3M<sup>®</sup> Thinsulate<sup>®</sup>-180 grams in the body and 100 grams in the sleeves

### FEATURES

- Two-way adjustable pit venting with mesh inserts
- Storm flap and wrist/waist gaiters to keep snow and cold out
- 3M<sup>®</sup> Scotchlite<sup>®</sup> Reflective Material for nighttime visibility

### WARMTH



### BREATHABILITY



### VERSATILITY



\$259<sup>99</sup>



FUCHSIA

Sizes: S-3XL  
2869914

BLUE PRINT

Sizes: S-3XL  
2868508

PINK/BLACK

Sizes: S-3XL  
2867731

BLACK/BLUE

Sizes: S-3XL  
2868507



BLACK  
Sizes: S-3XL  
2868542

### FULL-LEG YKK<sup>®</sup> ZIPPERS

Full-length YKK<sup>®</sup> zippers add venting options and make slipping on and off over boots easier.



UNINSULATED

## DIAMOND GORE-TEX<sup>®</sup> BIB



OUR MOST ADVANCED, HIGH-PERFORMANCE WOMEN'S BIB

### SHELL

- Durable 300D polyester outer fabric resists snagging or pilling
- Gore-Tex<sup>®</sup> membrane is waterproof, windproof, and breathable - guaranteed to keep you dry<sup>®</sup>
- Superior DWR prevents precipitation from saturating the bib's exterior

### FEATURES

- Back stretch side panels and adjustable shoulder straps for better fit and comfort
- Lower ankle gaiters to keep snow out and retention strap to keep gaiters from riding up
- 3M<sup>®</sup> Scotchlite<sup>®</sup> Reflective Material for nighttime visibility

### WARMTH



### BREATHABILITY



### VERSATILITY



\$454<sup>99</sup>



★ TOP SELLER

GRAY  
Sizes: S-3XL  
2867736

FULL-LENGTH YKK<sup>®</sup> SIDE ZIPS

BLACK  
Sizes: S-3XL  
2867735

LOWER ANKLE GAITERS KEEP SNOW OUT, AND A RETENTION STRAP KEEPS GAITERS FROM RIDING UP



INSULATED

## THROTTLE BIB



PERFECTLY TAILORED AND FEATURED FOR TODAY'S WOMAN RIDER

### SHELL

- Durable 300D polyester outer fabric resists snagging and pilling
- Superior DWR prevents precipitation from saturating the bib's exterior

### LINING

- Zonal 3M<sup>®</sup> Thinsulate<sup>®</sup> Insulation-180 grams on front of legs and 100 grams in the seat

### FEATURES

- Back stretch side panels and adjustable shoulder straps for better fit and comfort
- Fully articulated knee panels feature removable pads and offer greater range of movement
- Lower ankle gaiters keep snow out and a retention strap keeps gaiters from riding up
- 3M<sup>®</sup> Scotchlite<sup>®</sup> Reflective Material for night visibility

### WARMTH



### BREATHABILITY



### VERSATILITY



\$309<sup>99</sup>

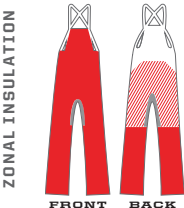

ZONAL INSULATION GUIDE:



NEW

# HEATED VEST

COMFORT WITH THE TOUCH OF A BUTTON

- Three heat settings that help you adjust to changing weather conditions
- Down-proof material with 160 grams of insulation
- Powered by a small rechargeable battery (included)
- Battery can be recharged via USB or any 12V outlet (for sled outlet, PN 2878475)
- Charge a cell phone with the rechargeable battery
- Machine washable with removable faux fur trimmed hood
- Perfect for any outdoor activity

STAY WARM AND CHARGE YOUR CELL PHONE WHILE YOU RIDE

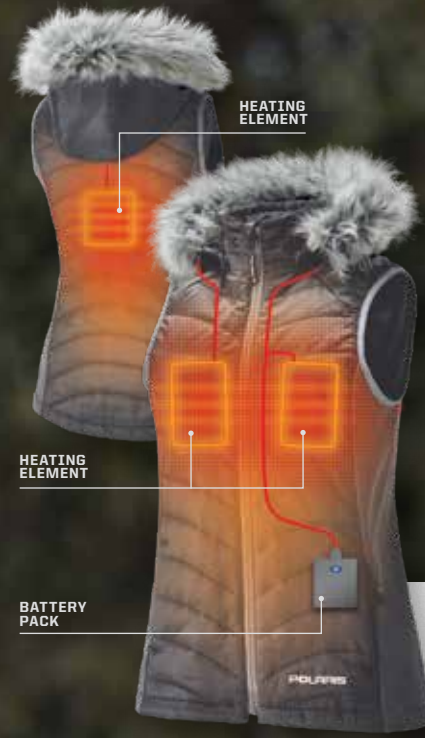

**DARK GRAY** **NEW**  
Sizes: S-3XL | 2869923

WARMTH

BREATHABILITY

VERSATILITY

LAYER: MID

\$259<sup>99</sup>

NEW



**AQUA**  
S-3XL | 2869556

**CORAL**  
S-3XL | 2867792

**BLACK**  
S-3XL | 2867791



**BLACK/BLUE**  
S-3XL | 2867894

**BLACK/GRAY**  
S-3XL | 2866032

**MARINA BLUE**  
S-3XL | 2868598

## TECH FULL-ZIP

EXCELLENT UNDERLAYER PERFORMANCE. FULL ZIP ADDS VENTING OPTIONS

- 100% poly fleece
- Brushed interior for superior comfort

WARMTH

BREATHABILITY

VERSATILITY

LAYER: MID

\$67<sup>99</sup>

## TECH QUARTER-ZIP

EXCELLENT UNDERLAYER PERFORMANCE IN AN EXCEPTIONALLY SOFT AND COMFORTABLE FABRIC

- High-performance garment is ideal as a mid-layer for riding or as a standalone layer
- Four-way stretch material is breathable and moisture-wicking to keep you warm and dry
- Cut and sewn for a contoured fit

WARMTH

BREATHABILITY

VERSATILITY

LAYER: MID

\$67<sup>99</sup>



NEW

**BLACK**  
S-3XL | 2869920

NEW

**CORAL**  
S-3XL | 2869921

**BLACK/PINK**  
S-3XL | 2868519

**BLUE/ORANGE**  
S-3XL | 2868518

## SOFTSHELL JACKET

GREAT JACKET THAT CAN BE WORN FOR RIDING AND EVERYDAY WEAR

- Casual jacket armed with rugged and warm features for everyday wear
- Superior DWR prevents precipitation from saturating the jacket's exterior
- Lined with 280 grams of soft fleece for warmth
- Removable hood and underarm venting, three external pockets, and one internal chest pocket

WARMTH

BREATHABILITY

VERSATILITY

LAYER: OUTER

\$169<sup>99</sup>



**GRAY/PINK**  
S-3XL | 2868516

**BLACK/BLUE**  
S-3XL | 2868517

## MID-LAYER

LAYER FOR VERSATILITY AND WARMTH WITH THIS BREATHABLE FLEECE MID-LAYER

- Extra layer of warmth for when you need it
- 280 grams of breathable fleece and wear-resistant polyester face
- Designed to fit under outer shell when riding
- Limited seams and inner spandex lining enhance fit without limiting range or adding unwanted bulk

WARMTH

BREATHABILITY

VERSATILITY

LAYER: MID

\$99<sup>99</sup>



TOP | Sizes: S-3XL  
2867795

BOTTOM | Sizes: S-3XL  
2867796

## LIGHTWEIGHT BASE LAYER

FOR MAXIMUM BREATHABILITY. PERFECT FOR RIDERS WHO ARE VERY ACTIVE

- Breathable, moisture-wicking poly/spandex fabric
- Four-way stretch
- Best for warmer days

WARMTH

BREATHABILITY

VERSATILITY

LAYER: BASE

\$59<sup>99</sup>



TOP | Sizes: S-3XL  
2866025

BOTTOM | Sizes: S-3XL  
2866026

## MIDWEIGHT BASE LAYER

ADD MORE INSULATION WHEN THE WEATHER TAKES A COLDER TURN

- 92% polyester, 8% spandex
- Soft brushed fleece liner
- Very warm; best for extreme cold

WARMTH

BREATHABILITY

VERSATILITY

LAYER: BASE

\$79<sup>99</sup>

WOMEN'S TECHNICAL WEAR

# FIND YOUR PERFECT HELMET

No matter your riding style or personal preference, Polaris® has the perfect helmet choice for you.

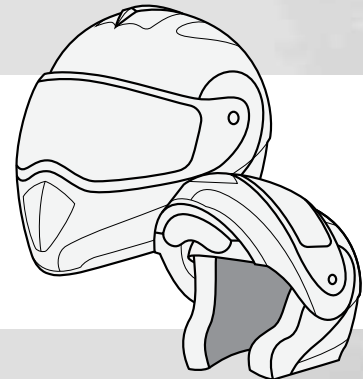

## MODULAR

- All-weather protection
- Versatile flip-open face shield
- Wide field of view
- Electric shield optional

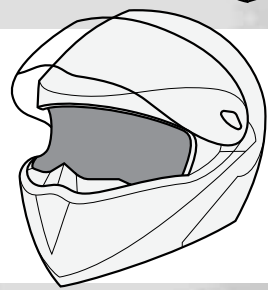

## FULL

- Maximum protection from elements
- Full anti-fogging protection
- Wide field of view
- Electric shield optional

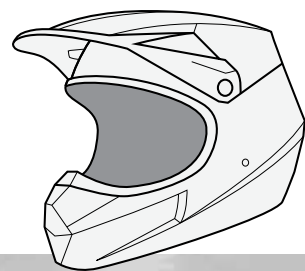

## MOTO

- For maximum ventilation and versatility
- Goggle and lens selection
- Convertible for summer use
- 509° Partnership



## SAFETY RATINGS EXPLAINED

**DOT:** Certification from the United States Department of Transportation

**ECE:** Standards set by the Economic Commission for Europe; similar to the DOT standards

## ULTIMATE PROTECTION FOR RIDERS

Polaris® uses industry-leading technologies and partners to provide options covering all conditions.



### TEKVEST® SUPERSOFT

S-3XL  
2862190 | \$414<sup>99</sup>



### TEKVEST® FREESTYLE

S-3XL  
2862189 | \$349<sup>99</sup>



### TEKVEST® SHOULDER PADS

S-3XL  
2862192 | \$104<sup>99</sup>

## GET THE PERFECT FIT

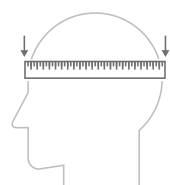

### MEASURE

Measure the circumference here for correct size. Make sure the inner lining fits snugly around your head without causing pain.

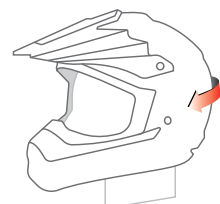

### MOVEMENT

Move the helmet side to side. Your scalp should move with it.



### CHINSTRAP

Check with your finger. If properly fit, your finger shouldn't fit between your chin and the strap.

## SIZING GUIDE

SIZE	XS	S	M	L	XL	2XL	3XL	4XL	5XL
SIZE CODE	00	02	03	06	09	12	14	15	16 F
HAT SIZE	6 3/4	6 7/8-7	7 1/8-7 1/4	7-7 1/2	7 5/8-7 3/4	7 7/8-8	8	8 3/4	8 1/2
CIRCUMFERENCE	20 7/8"-21 1/4"	21 5/8"-22"	22 3/8"-22 3/4"	23 1/8"-23 5/8"	24"-24 3/8"	24 3/4"-25 1/8"	25 1/4"-26"	26 3/8"-26 3/4"	27 1/8"-27 1/2"
	(53-54 cm)	(55-56 cm)	(57-58 cm)	(59-60 cm)	(61-62 cm)	(63-64 cm)	(65 cm)	(66 cm)	(69-79 cm)

# ECLIPSE MODULAR HELMET

SOPHISTICATED, FULL OF FEATURES, AND PERFECT FOR A LONG DAY ON THE TRAIL

\$414<sup>99</sup>

**SHELL**

- Injection-molded plastic

**WEIGHT**

- 1850 grams

**FEATURES**

- Added chin and neck sealing for comfort and noise protection
- Rubber silicone breath box for a contoured fit
- Patent-pending breath box attachment system for easy conversion
- Push-button air vent
- Steel hook and catch for closing mechanism
- Articulated chin bar with push-button action
- Added visual comfort with lever-activated, scratch-resistant sunshield
- Quick-release Proclip chinstrap
- Interior space for communication speakers
- Washable liner and cheek pads
- DOT-approved



**BLACK/BLUE**

Sizes: XS-5XL  
2868555 ES

**BLACK/GRAY**

Sizes: XS-5XL  
2868553 ES

**BLACK/RED**

Sizes: XS-5XL  
2868554 ES

**BLACK MATTE**

Sizes: XS-5XL  
2868552 ES

**BLACK MATTE\***

Sizes: XS-5XL  
2868556 | \$339<sup>99</sup>  
\*Electric shield not included

SIMPLY FLIP THE FRONT OF HELMET UP FOR TALKING, ETC.  
SECURELY LOCKS IN PLACE FOR RIDING

# MODULAR HELMET

SIMPLE IN DESIGN, BIG ON FEATURES AND FUNCTIONALITY

**SHELL**

- Injection-molded plastic

**FEATURES**

- Neoprene breath box
- Articulated chin bar with push-button action
- Durable plastic hook and catch for closing mechanism
- Two-finger, easy-open mechanism
- Added visual comfort with lever-activated, scratch-resistant sunshield

**WEIGHT**

- 1850 grams

\$299<sup>99</sup>



**BLACK MATTE**

Sizes: XS-5XL  
2868557

# BLAZE HELMET

LIGHTWEIGHT SHELL COMBINED WITH FULL-FACE PROTECTION

\$194<sup>99</sup>

**SHELL**

- Injection-molded plastic

**WEIGHT**

- 1450 grams

**FEATURES**

- Lightweight, dual-density, impact-absorbing EPS liner
- Proclip quick release strap
- Removable, machine-washable interior liner and cheek pads
- Breath guard and chin curtain included
- Durable dual-pane shield has anti-fog and anti-scratch coatings
- DOT-approved



**RED MATTE**

Sizes: XS-4XL  
2867806

**BLUE MATTE**

Sizes: XS-4XL  
2867807

**BLACK MATTE**

Sizes: XS-4XL  
2867805

# FORCE HELMET NEW

PACKED WITH FEATURES. PACKED WITH VALUE

**SHELL**

- Injection-molded plastic

**FEATURES**

- Wide field of vision
- Deep EPS canalization for better venting
- 11 intake and four exhaust vents
- Removable mouthpiece for easy cleaning
- Venting designed to keep goggles fog-free
- DOT- and ECE2205-certified

**WEIGHT**

- 1380 grams

\$194<sup>99</sup>

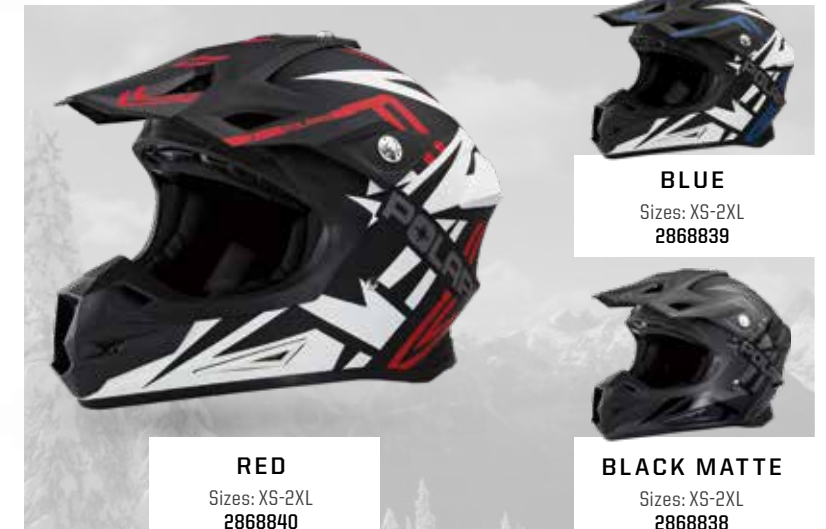

**RED**

Sizes: XS-2XL  
2868840

**BLUE**

Sizes: XS-2XL  
2868839

**BLACK MATTE**

Sizes: XS-2XL  
2868838

# TENACITY HELMET

ALL THE STYLE AND PROTECTION IN OUR MOST AFFORDABLE HELMET

\$144<sup>99</sup>

**SHELL**

- Injection-molded plastic

**WEIGHT**

- 1450 grams

**FEATURES**

- All the style and all the protection in our most affordable helmet
- Stay cool when pushing the limits with oversized mouth intake and top vents with six rear exits
- Stay warm on cold days with optional breath deflector or insert (sold separately)
- Removable, machine-washable liner keeps things fresh ride after ride
- DOT- and ECE2205-certified



**BLACK/GRAY**

Sizes: XS-2XL  
2868620

**BLUE GLOSS**

Sizes: XS-2XL  
2868622

**BLACK MATTE**

Sizes: XS-2XL  
2868619

**LIME GLOSS**

Sizes: XS-2XL  
2868621

**RED GLOSS**

Sizes: XS-2XL  
2868623

**PINK GLOSS**

Sizes: XS-2XL  
2868624

# 509® ALTITUDE CARBON HELMET

DURABLE, ULTRA LIGHTWEIGHT, CARBON FIBER

## SHELL

- Full carbon fiber shell

## WEIGHT

- 1100 grams

## FEATURES

- Fidlock® magnetic chin strap technology
- Revolutionary neck brace-ready shell profile
- Removeable breath box included
- Universal camera mount included
- Eight intake /exhaust vent ports
- Fully convertible between winter and summer use
- Three outer shell molds across eight sizes for excellent fit
- DOT- and ECE2205-certified

**\$519<sup>99</sup>**

# 509® ALTITUDE HELMET

STYLISH, LIGHTWEIGHT HELMET WITH 509® FIT AND FINISH

## SHELL

- Thermoplastic poly alloy outer shell

## WEIGHT

- 1260 grams

## FEATURES

- Revolutionary neck brace-ready shell profile
- Specially designed expanded polyurethane chin insert
- Eight intake/exhaust vents
- Universal camera mount included
- Removeable breath box included
- Three outer shell molds across eight sizes for excellent fit
- DOT- and ECE 2205-certified

**\$299<sup>99</sup>**



## 509 FOR POLARIS®

509® delivers the best in modern helmet and goggle integration, with every helmet and goggle designed to fit and seal the elements out together perfectly.

### CARBON MATTE

Sizes: S-4XL  
2867814

### CARBON GLOSS

Sizes: S-4XL  
2867815

### BLUE

Sizes: S-4XL  
2867820

### ORANGE

Sizes: S-4XL  
2867818

### LIME

Sizes: S-4XL  
2868539

### RED

Sizes: S-4XL  
2867819

### GRAY

Sizes: S-4XL  
2867817

## 509® FIDLOCK® CHIN STRAP TECHNOLOGY

Carbon Matte helmet features Fidlock® technology, an easy-on and easy-off magnetic closure device that delivers a quick, secure closure every time.

VISIT [POLARIS.COM/SHOP](https://www.polaris.com/shop) TO LEARN MORE



EASY TO ATTACH WITH YOUR GLOVES ON

## BALACLAVAS

### MOUNTAIN BALACLAVA

- Anti-fog neoprene nose guard
- One-Size  
2867745 | **\$26<sup>99</sup>**



### TRAIL BALACLAVA

- Laser-cut breath holes
- One-Size  
2867746 | **\$32<sup>99</sup>**



# GOGGLES



MIRRORED

LIME

2868657 | \$179<sup>99</sup>



POLARIZED

BLACK

2868528 | \$209<sup>99</sup>

## REVOLVER 509<sup>®</sup> SNOW GOGGLE

### THE NEXT EVOLUTION IN SNOWMOBILE GOGGLE TECHNOLOGY

- Innovative pivot lens lock technology allows lens to pivot up and away from frame
- Quickly release moisture and prevent fogging when stopped
- Dual-frame technology and triple foam face for comfort and a perfect seal
- Oversized spherical lens for side field of vision; maximum anti-fog and scratch resistance
- Outrigger support for strap for perfect "inside the helmet" fit for today's moto-style helmets

### REPLACEMENT LENSES



Clear	2868543	Polarized Smoke	2868546
Yellow	2868544		\$67 <sup>99</sup>
Chrome	2868545		\$39 <sup>99</sup>

## SINISTER X5 509<sup>®</sup> SNOW GOGGLE

### FEATURING EXCELLENT VISIBILITY, ANTI-FOG PERFORMANCE, AND DURABILITY

- Incredible style and premium performance for any rider
- The Outrigger mounting strap allows the goggles to seal tight to your face
- Unique Phantom frame technology eliminates goggle frame intrusion into field of view
- Durable polycarbonate lens is both scratch- and fog-resistant
- Oversized foam seals gaps between helmet and goggle frame for maximum warmth
- Choose from a wide range of replacement lenses in multiple colors and finishes

### REPLACEMENT LENSES

Clear	2865123	Rose	2865126
Yellow	2865124		\$32 <sup>99</sup>
Chrome	2865125	Polarized Yellow	2865127
	\$32 <sup>99</sup>	Polarized Smoke	2865128
			\$54 <sup>99</sup>

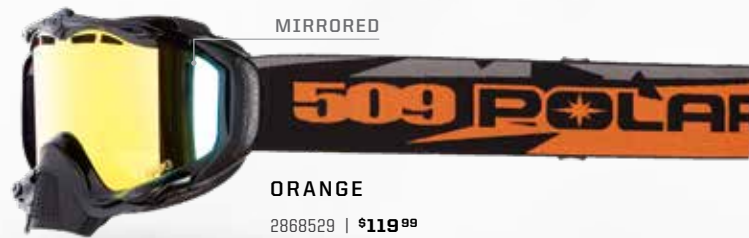

MIRRORED

ORANGE

2868529 | \$119<sup>99</sup>



POLARIZED

BLACK

2868531 | \$144<sup>99</sup>



LIME

2868530 | \$119<sup>99</sup>



NEW LIME

2869538 | \$79<sup>99</sup>



NEW RED

2869537 | \$79<sup>99</sup>



BLACK

2868532 | \$79<sup>99</sup>

## KINGPIN 509<sup>®</sup> SNOW GOGGLE

### PREMIUM MATERIALS IN AN AFFORDABLE PACKAGE

- Oversized lens delivers wide field of vision with scratch-resistant and anti-fog coating
- Contoured frame and triple-layer foam seals out cold and snow
- Removable nose piece delivers versatile cold weather protection
- Quick-change lens technology for fast lens tint swaps

### REPLACEMENT LENSES



Polarized Smoke	2868550
	\$54 <sup>99</sup>
Chrome/Yellow	2868549
Clear	2868547
Yellow	2868548
	\$32 <sup>99</sup>

### OWN THE PERFECT LENS FOR EVERY LIGHT CONDITION

### CARRY MULTIPLE LENSES SO YOU CAN EASILY ADJUST FOR LIGHTING



#### ROSE & CLEAR

- Delivers superior low-light visibility
- Increases contrast in cloudy conditions



#### YELLOW & GOLD

- Enhances flat-light terrain definition
- Delivers superior depth perception



#### SMOKE & BLUE

- Cuts down brightness without distorting color
- Reduces eyestrain

#### LENS COATINGS:

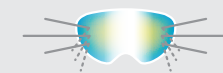

#### MIRRORED

- Reduces glare by reflecting light
- Maintains visibility of LCD readouts
- Paired with lighter tints to offset darkening



#### POLARIZED

- Substantially reduces glare and blinding
- Blocks horizontal light waves
- Decreases eyestrain

509 FOR POLARIS<sup>®</sup>

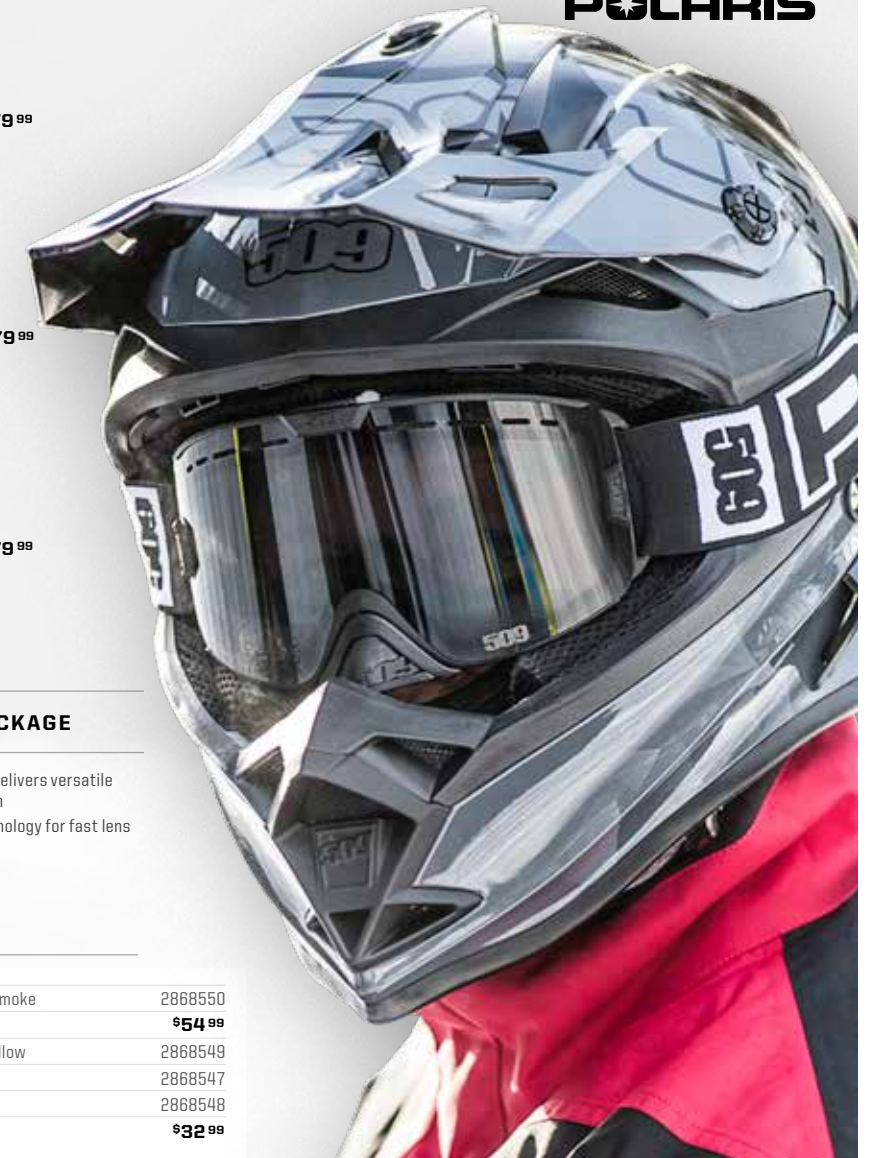



## UNINSULATED GLOVES



Sizes: S-3XL  
2867744  
**\$79 99**

STANDARD



Sizes: S-3XL  
2868522  
**\$89 99**

MEDIUM



Sizes: S-3XL  
2868523  
**\$104 99**

EXTREME



Sizes: S-2XL  
2867723  
**\$67 99**

### MOUNTAIN LEVEL 1

#### POPULAR VALUE-PACKED GLOVE FOR ACTIVE OFF-TRAIL RIDING

- Synthetic leather palm with silicone print for a sure grip
- Adjustable wrist strap seals out snow
- Dry-zone anti-slip insert
- Built-in goggle squeegee on backside of glove to keep vision clear

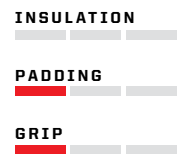

### MOUNTAIN LEVEL 2

#### A PERFECT BLEND OF THIN, LIGHTWEIGHT MATERIAL AND WARMTH

- Polyurethane palm for excellent grip while isolating hands from vibration
- Moisture-wicking liner keeps hands dry; 100 grams of insulation for warmth
- Backhand Armor provides protection from branches and debris
- Features adjustable wrist enclosures and integrated goggle squeegee

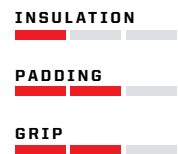

### MOUNTAIN LEVEL 3

#### OUR WARMEST SHORT-CUFF RIDING GLOVE COMBINED WITH MOBILITY

- Leather palm combines superior grip and long-lasting wear qualities
- Moisture-wicking liner keeps hands dry; 160 grams of insulation for maximum warmth
- Backhand Armor provides protection from branches and debris
- Features adjustable wrist enclosures and integrated goggle squeegee

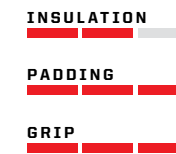

### SOFTSHELL RACE GLOVE

#### DESIGNED FOR HIGHLY ACTIVE RIDING AND RACING

- Inspired by professional Polaris® race team members
- Pre-curved design for maximum comfort and handlebar control
- Palm material provides ideal grip without unwanted vibration
- Foam padded inserts absorb impacts and vibration
- Neoprene cuff features adjustable closure for a secure, comfortable fit
- Reinforced seams and material in key areas for maximum durability

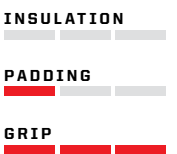

## INSULATED GLOVES



Sizes: S-3XL  
2867743  
**\$84 99**

STANDARD



Sizes: S-3XL  
2868520  
**\$99 99**

MEDIUM



Sizes: S-3XL  
2868521  
**\$114 99**

EXTREME



Sizes: S-2XL  
2869526  
**\$99 99**

NEW

### TRAIL LEVEL 1

#### POPULAR VALUE-PACKED GLOVE FOR TRAIL RIDING

- Synthetic leather palm with silicone print for a sure grip
- Fully insulated with 100 grams on the back of the hand and 60 grams on the palm
- Night riding safety with built-in 3M® Scotchlite® Reflective Material
- Adjustable wrist strap and gauntlet shock cord closure
- Dry-zone anti-slip insert
- Built-in goggle squeegee on backside of glove to keep vision clear

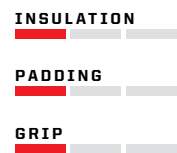

### TRAIL LEVEL 2

#### VERSATILE PERFORMANCE WITH A PERFECT BLEND OF MATERIAL

- Over-jacket gauntlet seals out cold and snow, ideal for trail riding
- Polyurethane palm for optimum grip while isolating hands from vibration
- Moisture-wicking liner keeps hands dry; 100 grams of insulation for warmth
- Backhand Armor provides protection from frost and ice chunks
- Features adjustable wrist enclosures and integrated goggle squeegee

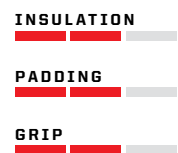

### TRAIL LEVEL 3

#### OUR WARMEST LONG-CUFF TRAIL RIDING GLOVE FOR EXCELLENT WARMTH

- Long wrist, over-the-jacket gauntlet seals out snow and cold with pull-tight shock cords
- Leather palm combines superior grip and long-lasting wear qualities
- Moisture-wicking liner keeps hands dry; 200 grams of insulation for maximum warmth
- Backhand Armor provides protection from frost and ice chunks
- Features adjustable wrist enclosures and integrated goggle squeegee

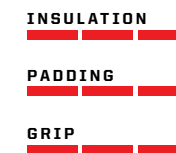

### WOMEN'S TRAIL 2 GLOVE

#### EXCELLENT GLOVE OFFERING ALL-AROUND VALUE AND PERFORMANCE

- 150 grams poly fill insulation
- Nylon Oxford shell & Amara® palm
- Gauntlet-style cuff with elastic pull & toggle
- Amara® pull patch makes it easy to pull gloves on

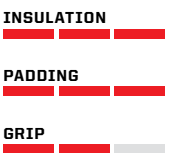

MAKE SURE YOUR HANDS STAY WARM WHEN THE NIGHTTIME COLD SETS IN. PACKING MULTIPLE GLOVES MEANS MAXIMUM COMFORT.

# BOOTS



HIGHLY VISIBLE 3M® SCOTCHLITE® REFLECTIVE MATERIAL



ICE LOCK® SOLE TECHNOLOGY



600 GRAMS OF 3M® THINSULATE® INSULATION

### BOA SYSTEM VS. LACES

Push to engage. Turn to tighten. Pull for quick release. The BOA lacing system gives a perfect fit with the turn of a knob—even with gloves on.



## SWITCHBACK BOOT

### PERFORMANCE, WARMTH, AND COMFORT

- Dry-Lex® membrane keeps feet dry, 3M® Thinsulate® delivers unmatched warmth for all-day comfort
- Constructed from durable leather for long-lasting wear season after season
- Lightweight design is extremely comfortable and perfect for active riders
- Ice Lock® sole with microscopic glass shards for sure grip on slippery surfaces

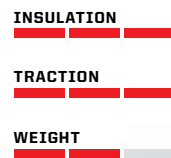

### BOA SYSTEM

Sizes: 5-14  
2868527 | \$359.99

### SWITCHBACK BOOT

Sizes: 5-14  
2865040 | \$259.99

# BEANIES

## TECH MESH



### MEN'S TECH MESH BEANIE

Black | 2868650 | \$26.99



### WOMEN'S TECH MESH BEANIE

Black | 2868646 | \$26.99  
Gray | 2868647 | \$26.99

A beanie can be the perfect item to put on when you take your helmet off. It is lightweight, warm, and means no one will see your mussed hair. Priorities. Featuring CarbonASR™ heat-regulating technology. Carbon fibers absorb your body's warmth, store it, and release it when needed, making these Tech Mesh Beanies the most advanced on the market.



### MESH STRETCH BEANIE

Charcoal Heather | 2868649 | \$26.99

## MEN'S



### NORTHERN STAR BEANIE

Black | 2867751 | \$17.99  
Gray | 2867752 | \$17.99

### RETRO CUFF BEANIE

Blue | 2867753 | \$19.99  
Black | 2867754 | \$19.99

### REVERSIBLE CAMO BEANIE

Orange | 2867756 | \$26.99  
White | 2868648 | \$26.99

## WOMEN'S



### WOMEN'S CABLE BEANIE

Berry | 2868643 | \$26.99



### SHATTERED CUFF CAP

Gray | 2868651 | \$19.99  
Lime | 2868652 | \$26.99



### WOMEN'S SEED STITCH BEANIE

Gray (Shown) | 2868645 | \$26.99  
Navy (Shown at top of page) | 2868644 | \$26.99



### AFTER THE RIDE

NEW

#### RETRO LOGO HOODIE

\$74<sup>99</sup>  
Black | S-3XL | 2869549  
Charcoal/Lime | S-3XL | 2868578  
Gray/Orange | S-3XL | 2868577  
Red | S-3XL | 2867786

#### ROSEAU PULLOVER HOODIE

\$74<sup>99</sup>  
Charcoal Heather | S-3XL | 2869553  
Navy Heather | S-3XL | 2868575  
Olive Heather | S-3XL | 2868576



NEW

#### COLOR BLOCK HOODIE

\$74<sup>99</sup>  
Black | S-3XL | 2869530  
Navy | S-3XL | 2869532



NEW

#### ESTA CREW SWEATSHIRT

\$67<sup>99</sup>  
Charcoal Heather | S-3XL | 2869550  
Navy | S-3XL | 2868574



NEW

#### RACE TECH FULL-ZIP

\$104<sup>99</sup>  
Black | S-3XL | 2869533

RACE



#### PULLOVER RACE HOODIE

\$74<sup>99</sup>  
Gray | S-3XL | 2868559

RACE



#### RACE HOODIE

\$84<sup>99</sup>  
Gray | S-3XL | 2868558

RACE



NEW

#### MEN'S SCAPE TEE

\$26<sup>99</sup>  
Heather Ash | S-3XL | 2869548  
Royal Heather | S-3XL | 2868569



NEW



#### ESTA TEE

\$26<sup>99</sup>  
Charcoal | S-3XL | 2869552  
Navy | S-3XL | 2869562  
Black | S-3XL | 2868570



#### RPM RACE TEE

\$26<sup>99</sup>  
Gray | S-3XL | 2868562  
Black | S-3XL | 2867781

RACE



#### RETRO TEE LONG SLEEVE

\$54<sup>99</sup>  
Gray | S-3XL | 2868571  
Navy | S-3XL | 2868572



#### RMK® TEE

\$32<sup>99</sup>  
Charcoal Heather | S-3XL | 2868565



#### SWITCHBACK® TEE

\$32<sup>99</sup>  
Heather Gray | S-3XL | 2868566



**NEW**

**HEX TEE**

**\$32.99**

Ash Heather | S-3XL | 2869551  
Navy Heather | S-3XL | 2868568  
Black | S-3XL | 2867770



**NEW**

**MFG TEE**

**\$32.99**

Ash Heather | S-3XL | 2869554  
Navy | S-3XL | 2868777  
Black | S-3XL | 2868776



**TECH PIT SHIRT**

**\$74.99**  
Black | XS-4XL | 2868560



Inspired by top Polaris® race teams, the Tech Shirt sleeves feature Polaris partner logos Walker Evans®, Camso®, Stud Boy®, and Axalta.

**TECH RACE PIT SHIRT**

**\$74.99**

Black | S-3XL | 2868561



**TECH POLO**

**\$67.99**

Black | S-4XL | 2868567



**NEW**

**ROSEAU TEE**

**\$32.99**

Charcoal Heather | S-3XL | 2869560  
Ash Heather | S-3XL | 2869561  
Burgundy | S-3XL | 2867471  
Navy Heather | S-3XL | 2867778

**NEW**



**PATCH CORE FLEX CAP**

**\$32.99**

Black | S/M | 2868579  
Black | L/XL | 2868580  
Navy | S/M | 2868581  
Navy | L/XL | 2868582



**NEW**

**RETRO CAP**

**\$32.99**

Gray/Orange | One-Size | 2867758  
Gray/Red | One-Size | 2869542  
Navy/Lime | One-Size | 2869543



**NEW**

**EXHAUST TEE**

**\$32.99**

Navy Heather | S-3XL | 2869567  
Ash Heather | S-3XL | 2869568



**NEW**

**RETRO TRUCKER CAP**

**\$32.99**

Navy | One-Size | 2869539  
Red | One-Size | 2869540  
Black | One-Size | 2868583



**A CLASSIC RACING CAP**

**\$32.99**

Navy | One-Size | 2867760  
Black | One-Size | 2867761

**B HEX CAP**

**\$32.99**

One-Size | 2867766

**C CORE CAP**

**\$32.99**

Navy | One-Size | 2869544  
Black | One-Size | 2867762

**D STEALTH CAMO**

**\$32.99**

One-Size | 2867765

**NEW**

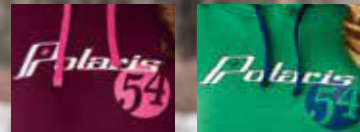

**NEW**



**RETRO PULLOVER HOODIE**

**\$67<sup>99</sup>**  
 Navy | S-3XL | 2869555  
 Berry | S-3XL | 2868592  
 Kelly Green | S-3XL | 2868593



**RETRO FULL-ZIP HOODIE**

**\$74<sup>99</sup>**  
 Navy | S-3XL | 2868594  
 Charcoal Heather | S-3XL | 2868595

**RACE HOODIE**

**\$74<sup>99</sup>**  
 Gray | S-3XL | 2868600

**RACE**



**NEW**



**NEW**



**SCRIPT CREW SWEATSHIRT**

**\$67<sup>99</sup>**  
 Aqua | S-2XL | 2869557  
 Gray | S-2XL | 2867867  
 Charcoal Heather | S-2XL | 2868603



**NEW**

**RACE**

**RACE TECH FULL-ZIP**

**\$104<sup>99</sup>**  
 Black | S-3XL | 2869534



**RACE**

**RACE TEE**

**\$26<sup>99</sup>**  
 Gray | S-3XL | 2868599



**NEW**

**ROSEAU TEE**

**\$32<sup>99</sup>**  
 Gray | S-3XL | 2869559  
 Black/Lime | S-3XL | 2868586  
 Navy | S-3XL | 2868587



**NEW**

**HEX TEE**

**\$32<sup>99</sup>**  
 Gray | S-2XL | 2869566  
 Navy | S-2XL | 2869565



**NEW**

**NEW**

**RETRO CAP**

**\$32<sup>99</sup>**  
 Blue | One-Size | 2869545  
 Light Blue | One-Size | 2869547  
 Gray | One-Size | 2868617  
 Berry | One-Size | 2868616

**ASYMMETRICAL HOODIE**

**\$74<sup>99</sup>**  
 Black | S-3XL | 2868597  
 Berry | S-3XL | 2868596



**NEW**

**V-NECK SCRIPT TEE**

**\$26<sup>99</sup>**  
 Gray | S-3XL | 2868588  
 Navy | S-3XL | 2868589  
 Black | S-3XL | 2869558



**NEW**

**BASEBALL TEE 3/4 SLEEVE**

**\$46<sup>99</sup>**  
 White/Gray | S-3XL | 2869563  
 Gray/Pink | S-3XL | 2868584  
 Dark Gray | S-3XL | 2868585

# YOUTH



## RIPPER JACKET

- Durable 3000 polyester outer fabric resists snagging and pilling
- Built-in, zonal 3M<sup>®</sup> Thinsulate<sup>®</sup> Insulation—180 grams in body, 100 grams in sleeves and neck
- Two external pockets & internal zip pockets
- Long-lasting YKK<sup>®</sup> zippers in all closures, main closure features storm flap
- 3M<sup>®</sup> Scotchlite<sup>®</sup> Reflective Material for nighttime visibility

Lime Print  
S-XL | 2868510  
Blue Print  
S-XL | 2867738

**\$179<sup>99</sup>**



## DIVA JACKET

- Durable 3000 polyester outer fabric resists snagging and pilling
- Built-in, zonal 3M<sup>®</sup> Thinsulate<sup>®</sup> Insulation—180 grams in body, 100 grams in sleeves and neck
- Two external pockets & internal zip pockets
- Long-lasting YKK<sup>®</sup> zippers in all closures, main closure features storm flap
- 3M<sup>®</sup> Scotchlite<sup>®</sup> Reflective Material for nighttime visibility

Marina Blue  
S-XL | 2868511  
Pink Print  
S-XL | 2867739

**\$179<sup>99</sup>**



## RIPPER BIB

- 3000 soft durable shell fabric with DWR (Durable Water Repellent)
- 3M<sup>®</sup> Thinsulate<sup>®</sup> zonal insulation—180 grams where it's needed most and 100 grams where it's not
- The ultimate youth bib for riding or playing in the snow
- Unique "Grow With Me" double seam design allows bibs to lengthen up to 2" as your child grows

Gray | S-XL | 2867741  
Black | S-XL | 2867742

**\$179<sup>99</sup>**



## POLARIS<sup>®</sup> BOOT

- Youngsters will enjoy reliable warmth in all their winter activities with these waterproof, comfortable boots
- Removable 8 mm moisture-wicking Zylex<sup>®</sup> liner (rated to -40°F)
- Lightweight and waterproof synthetic rubber shell; waterproof 600 denier nylon upper
- High-traction rubber outsole
- Lace lock on snow collar

**\$104<sup>99</sup>**  
1-6 | 2864196



TEKVEST<sup>®</sup>  
**\$284<sup>99</sup>**  
Black | One-Size | 2862191



## TURBO HELMET

- The strong, durable, injection-molded thermoplastic ABS shell provides protection against impact, wind, and the elements
- Chin, forehead, and rear exhaust vents
- Removable, washable liner and breath deflector
- DOT/ECE-approved

**\$144<sup>99</sup>**  
S-L | 2867747  
SIZE GUIDE P. 41



## REVERSIBLE BEANIE

- Two beanies in one with this reversible design with right-fit sizing for kids

**\$14<sup>99</sup>**  
Blue | S-XL | 2868639  
Lime | S-XL | 2868640  
Pink | S-XL | 2868641  
Marina Blue | S-XL | 2868642

**NEW**

## GLOVE

- Mapped insulation with 200 grams on back of hand and 100 grams on palm
- Goggle squeezegee on index and nose wipe on the back of thumb
- Gauntlet shock cord closure to keep snow and cold out

**\$46<sup>99</sup>**  
Black | S-XL | 2869529



## RACE PULLOVER HOODIE

**\$54<sup>99</sup>**  
Gray | S-XL | 2868604

## RETRO PULLOVER HOODIE

**\$54<sup>99</sup>**  
Blue/Lime | S-XL | 2868608  
Gray/Orange | S-XL | 2868609



## RETRO FULL-ZIP HOODIE

**\$54<sup>99</sup>**  
Black | S-XL | 2868610  
Berry | S-XL | 2868611



## LONG SLEEVE RETRO TEE

**\$39<sup>99</sup>**  
Blue | S-XL | 2868605  
Kelly Green | S-XL | 2868607



## SCAPE TEE

**\$24<sup>99</sup>**  
Ash | S-XL | 2869569  
Red | S-XL | 2869570



## SLED GRAPHIC TEE

**\$24<sup>99</sup>**  
Gray/Orange | S-XL | 2868612  
Blue/Lime | S-XL | 2868613



## SCRIPT TEE

**\$24<sup>99</sup>**  
Silk | S-XL | 2869571  
Raspberry | S-XL | 2869572



## HEX TEE

**\$24<sup>99</sup>**  
Berry | S-XL | 2868614  
Navy | S-XL | 2868615

## SIZING GUIDE

Size:	XS	SM	MD	LG	XL
Chest:	22-23	24-25	26-27	28-29	30-31
Waist:	20-21	22-23	24-25	26-27	28-29
Sleeve:	14-17	16-21	22-23	23-24	24-25
Inseam:	15	18	21	23	25

## HELMET SIZING GUIDE

Size	S	M	L	XL
Size Code	02	03	06	09
Circumference	20 3/8"	20 5/8"	21 1/8"	22 3/8"
	(51-52 cm)	(53-54 cm)	(55-56 cm)	(57-58 cm)

## BOOT SIZING GUIDE

Size Code	01	02	03	04	05	06	07	08	09	10	11	12	13
Size	1	2	3	4	5	6	7	8	9	10	11	12	13

# MERCHANDISE



**POLARIS® TRAVEL MUG**  
2866248 | \$36<sup>99</sup>

**VINYL WINDOW STICKER**  
2866256 | \$19<sup>99</sup>



**RETRO CLOCK**  
2868662 | \$39<sup>99</sup>

**POLARIS® PINT GLASS**  
(SET OF 2)  
2866265 | \$19<sup>99</sup>



**ROSEAU MUG**  
2868665 | \$19<sup>99</sup>

**RETRO MUG**  
2868664 | \$19<sup>99</sup>



**POLARIS® BABY ONESIE**  
• Available sizes: 3-6 months, 6-12 months, and 12-18 months

Pink	2867463
Blue	2867462
	<b>\$19<sup>99</sup></b>



**POLARIS® KEYCHAIN**  
Blue  
2868618  
**\$19<sup>99</sup>**



**POLARIS® STICKERS**

6" Sticker	2866257	\$3 <sup>99</sup>
12" Sticker	2866258	\$6 <sup>99</sup>
24" Sticker	2866259	\$11 <sup>99</sup>
48" Sticker	2866260	\$23 <sup>99</sup>



**POLARIS® SWITCHBACK® DIE CAST**

White	2868635
Blue	2868636
	<b>\$25<sup>99</sup></b>

# OGIO



## OGIO® 9800 RIG ROLLER

- SLED (Structural Load Equalizing Deck) system for increased durability and handling in the harshest of conditions
- Wide-mouth LID opening for easy access to all gear compartments
- Large main compartment with adjustable dividers and padded helmet chamber
- iFOM (integrated foam) construction throughout for added gear protection
- Heavy-duty oversized wheels with extra clearance
- Telescoping pull handle

2867869 | \$349<sup>99</sup>



### OGIO® BIG MOUTH GEAR BAG

- Extra-large access to main volume
- Ogio® SKID system includes large diameter wheels and axles
- Dimensions: 31.50" H x 16" W x 18" D

2867870 | \$259<sup>99</sup>

### OGIO® ALL ELEMENTS BACKPACK

- Completely waterproof roll top construction
- 420D nylon
- Dimensions: 20.5 (rolled)" H x 10.5" W x 6.75" D

2867873 | \$169<sup>99</sup>

### OGIO® AXIL LAPTOP BACKPACK

- Airport checkpoint-friendly laptop compartment fits most 17" laptops
- Multiple organization pockets
- 840D double ripstop face coated
- Dimensions: 19.25" H x 13" W x 9.25" D

2867872 | \$129<sup>99</sup>

### OGIO® SLAYER GEAR BAG

- Separate internal pockets
- Heavy-duty 900D fabric with eco-friendly PVC backing specs
- Dimensions: 31.50" H x 16" W x 18" D

2867871 | \$119<sup>99</sup>

POLARIS® SNOWMOBILES



**RMK®**

LIGHTEST. STRONGEST.  
MOST FLICKABLE.



**SWITCHBACK®**

SMOOTHEST RIDING.  
MOST VERSATILE.



**RUSH®**

SHARPEST HANDLING.  
QUICKEST ACCELERATING.



**POLARIS TITAN®**

UNMATCHED CAPABILITY.  
UNCOMPROMISING PERFORMANCE.



**INDY®**

LEGENDARY PERFORMANCE.  
SIMPLY FUN.



**VOYAGEUR®**

LIMITLESS  
POSSIBILITIES.



RIDE-DEFINING  
ACCESSORIES

**KNOW YOUR CHASSIS FOR THE PERFECT FIT**

Depending on the model of snowmobile you have and the model year, you may have either a Pro-Ride® chassis or an AXYS® chassis. Please consult the chart below to determine which chassis you have and order accordingly.

	PRO-RMK®, RMK® Assault®, SKS	Switchback® Assault® 144 & RMK® 144	Switchback®	Switchback® SP	Rush®	Polaris® Titan™	Indy® 600 & 800	600 Voyager®	550 Indy® 121"-144"	All 550 Voyager®	550 Indy® LXT, Indy® Adventures	129 XC Indy®	Indy EVO™
<b>AXYS®</b>	MY16-MY19	MY17-19	MY15-MY19	MY17-MY19	MY15-MY19	MY18-19		MY17-19				MY19	
<b>PRO-RIDE®</b>	MY11-MY15	MY11-MY16	MY10-MY14		MY10-MY14		MY13-MY19	MY14-MY16	MY13-MY19	MY13-MY19	MY13-MY19		MY19



# ENGINEER A MORE PERFECT RIDE

Polaris Engineered Accessories™ are the only accessories engineered and designed exclusively with your sled. That's why every accessory fits perfectly, is covered by your factory warranty and is tested, trusted, and proven to make your next ride an even better one. Whether that's more comfort, personal style, control, storage, or more peace of mind, only Polaris Engineered Accessories guarantee the ultimate ride experience.

## WHEN ONLY THE VERY BEST WILL DO:

- PERFECT FIT
- SEAMLESS INTEGRATION
- FACTORY COLOR MATCHING
- LIMITLESS COMBINATIONS

HANDLEBARS  
P. 78

WINDSHIELDS  
P. 68

BUMPERS  
P. 70

SKIS  
P. 82

SEATING  
P. 66

STORAGE  
P. 58

RUNNING BOARDS  
P. 72

### LOCK & RIDE®

#### EASY ON & EASY OFF.

Items with the Lock & Ride® logo feature our exclusive easy-on, easy-off installation technology. Engineer the perfect ride with accessories like storage racks or passenger seats quickly and efficiently without tools. And when you don't need them, removal is simple.

## POLARIS® PARTNERS WITH THE BEST

We choose our partners carefully, selecting only the best in snowmobiling. Every accessory is rigorously tested and validated by Polaris® standards to ensure seamless integration.



CALIBER™ P. 81



ARCTICFX® P. 75



CAMSO® P. 86



WOODY'S® P. 83 & 85



P.58 STORAGE

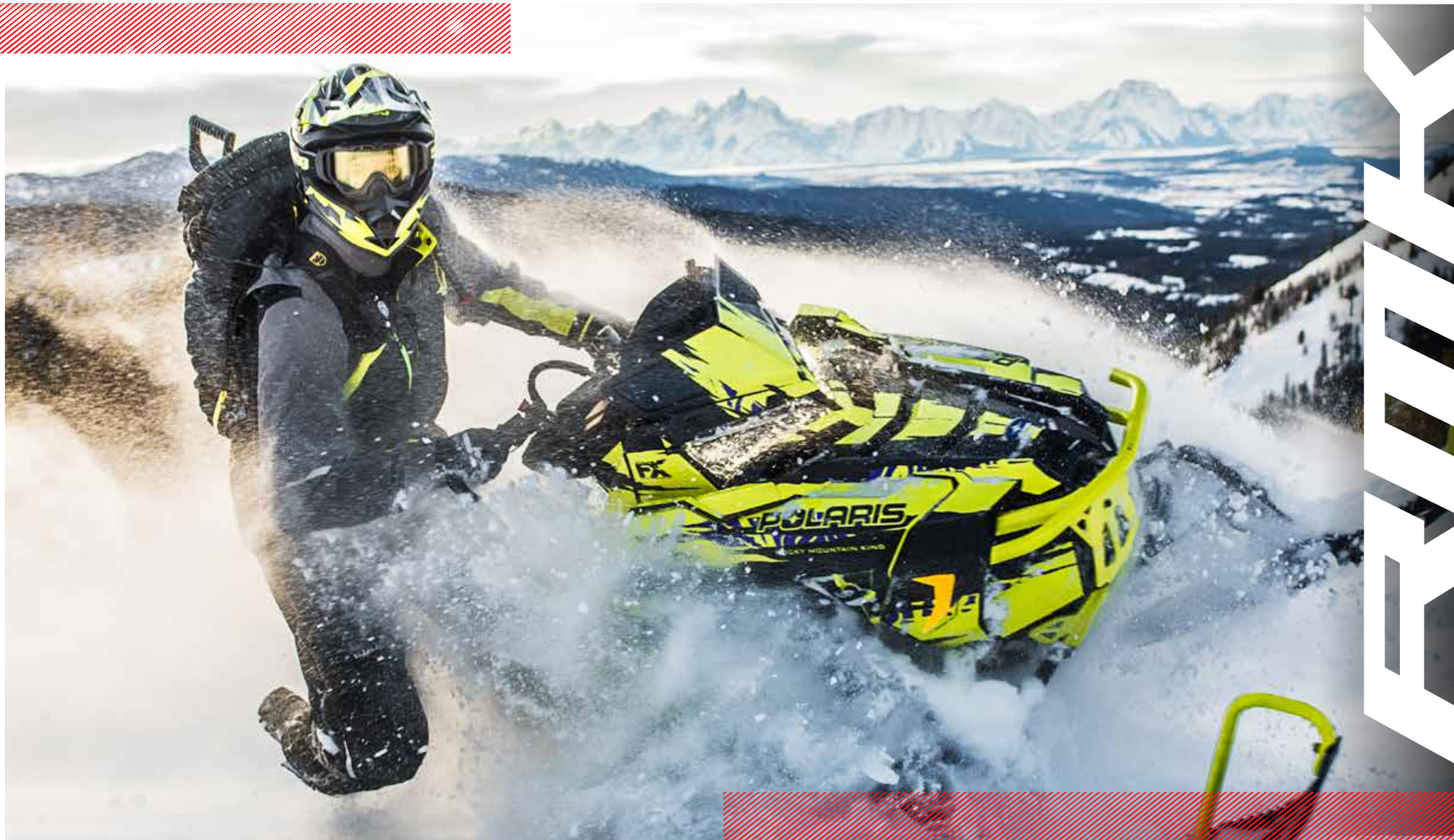

## MADE FOR THE MOUNTAIN

Make discovering impossible places possible. Set the high mark or float your line effortlessly with high-performance accessories engineered to add comfort, versatility, and custom style to your RMK®.



P.66 SEATING



P.68 WINDSHIELDS



P.70 PROTECTION



P.58 STORAGE



P.66 SEATING



P.68 WINDSHIELDS



P.70 PROTECTION



## THE WORLD'S YOUR PLAYGROUND

Discover a life on and off the beaten path. From a 2-up seat to added storage and more, build up your Switchback® and make it the crossover to envy in your riding group.

# SWITCHBACK®



P.68 WINDSHIELDS



P.70 PROTECTION



P.58 STORAGE



P.66 SEATING

## OWN THE TRAIL

You demand a lot from your RUSH®. Make sure you dial it in perfectly, and with your personal style, using the proper parts and accessories. When the group wants to ride hard, make sure you are locked in – and the one leading the pack.



**P.58** STORAGE



**P.66** SEATING



**P.68** WINDSHIELDS

## PURE CAPABILITY

Find unrivaled confidence while in the backcountry, hitting the trail, or when working. Your Polaris® TITAN™ is engineered to perform a multitude of roles. Integrate the proper accessories and tailor it to your needs.



**P.70** PROTECTION



 POLARIS®

# TITAN™



P.58 STORAGE



P.66 SEATING



P.68 WINDSHIELDS

## INDY® PERFORMANCE REBORN

The most iconic name in snowmobiling has been reborn. Add smart storage, seating, protection and personal style across the expanded INDY® lineup, including the INDY® XC 129 with AXYS® Chassis.



P.70 PROTECTION



# INDY®

# STORAGE & RACKS

STORAGE SHOPPING BASICS: FRONT TO BACK

<p><b>WINDSHIELD / DASH / HANDLEBAR / GOGGLE STORAGE</b></p> <p>Perfect for items you need quick access to on the trail.</p>	<p><b>UNDERSEAT STORAGE</b></p> <p>Storage for a map, or for larger items like a first-aid kit and extra goggles.</p>	<p><b>TUNNEL STORAGE</b></p> <p>Perfect for holding enough items for a destination trip.</p>	<p><b>CARGO RACK STORAGE</b></p> <p>Strong and durable with versatile bag and accessory options.</p>
--	---	--	--

## WINDSHIELD / DASH STORAGE

**WINDSHIELD BAG** AXYS®

- Bag installs inside base of windshield using stock push-dart fasteners
- Compression-molded semi-rigid material
- Uses engine heat to warm/dry goggles and gloves

Low Pro | 2880481 | **\$164<sup>99</sup>**  
ALL AXYS® AND POLARIS® TITAN™. ONLY FITS WITH LOW WINDSHIELD

Large | 2880374 | **\$164<sup>99</sup>**  
ALL AXYS® AND POLARIS® TITAN™. DOES NOT FIT WITH LOW WINDSHIELD

**LOW PRO** **330** CUBIC INCHES

**LARGE** **350** CUBIC INCHES

**WINDSHIELD REPLACEMENT BAG** AXYS®

- Combination windscreen and storage bag adds function and style
- Perfect for deep snow applications where over-the-hood sight lines are required
- Delivers quick access to personal items
- Semi-rigid design retains its shape even when empty or when the sled needs to be rolled to maneuver out of a stuck position

2882917 | **\$194<sup>99</sup>**  
ALL AXYS® AND POLARIS® TITAN™. REPLACES WINDSHIELD

**340** CUBIC INCHES

**MOUNTAIN DASH BAG** AXYS®

- Semi-rigid, compression-molded bag installs on dashboard
- Convenient, protected storage for two bottles of water, goggles, and gloves
- Installs easily, holds its shape empty or full

2880375 | **\$129<sup>99</sup>**  
PRO-RMK® MY16-19, SKS 155 MY16-19, RMK® ASSAULT® MY16-19

**600** CUBIC INCHES

**ULTIMATE DEFROST BAG** PRO-RIDE®

- Provides warm, dry place for goggles, gloves, and more
- Rigid construction holds its shape
- Durable 1,680-denier black ballistic nylon with water-resistant coating

2879090 | **\$179<sup>99</sup>**  
MY10-19 PRO-RIDE®, INCLUDES INDY® AND VOYAGEUR®, P.I.D.D. NOT INCLUDED

## HANDLEBAR / GOGGLE STORAGE

**CELL PHONE CHARGING BAG** NEW AXYS®

- Charge your cell phone while the engine is running
- Includes wire harness, which connects to the sled's electrical system
- Use your device's charging cable to attach via USB connection inside bag

2883687 | **\$169<sup>99</sup>**  
FITS ALL AXYS® WITH 5", 6", OR 7" RISE PROTAPER® BAR

2883786 | **\$169<sup>99</sup>**  
FITS ALL AXYS® FLAT BAR APPLICATIONS

**165** CUBIC INCHES

**GOGGLE HANDLEBAR BAG** AXYS®

- Conveniently access spare goggles from the driver's seat
- Attaches directly to handlebars with secure Velcro® straps

2882823 | **\$119<sup>99</sup>**  
ALL AXYS®

**190** CUBIC INCHES

**HANDLEBAR MAP BAG** AXYS® PRO-RIDE®

- Clear poly window displays trail map for easier navigation
- Attaches easily with all-weather Velcro® strips

2882824 | **\$41<sup>99</sup>**  
ALL SNOWMOBILES

**165** CUBIC INCHES

**HEATED UNDERHOOD STORAGE** AXYS®

- Underhood storage is ideal for storing goggles and keeping them defrosted
- Perfect for cold rides or deep powder days when swapping goggles is necessary
- Attaches securely using a bracket with fasteners and Velcro® straps

2882117 | **\$194<sup>99</sup>**  
ALL AXYS®, DOES NOT FIT POLARIS® TITAN™ OR WITH 850 ENGINE

**355** CUBIC INCHES

**HANDLEBAR BAG** AXYS® PRO-RIDE®

- Durable, compression-molded semi-rigid material
- Two zippered compartments to hold small items

2880443 | **\$104<sup>99</sup>**  
ALL AXYS® RUSH®, AXYS® SWITCHBACK®, ALL INDY® VOYAGEUR®, MY12-14 SWITCHBACK®, MY17-19 AXYS® 144, MY18-19 SKS 146, MY18-19 POLARIS® TITAN™. DOES NOT WORK WITH ROX® RISER (2881410)

**190** CUBIC INCHES

**UNDERHOOD GOGGLE BAG** PRO-RIDE®

- Heavy-duty nylon bag mounts under hood above exhaust
- Gloves, goggles, etc. are warmed by engine heat

2878735 | **\$94<sup>99</sup>**  
ALL PRO-RIDE®

**210** CUBIC INCHES

**PROTAPER® HANDLEBAR BAG** AXYS® PRO-RIDE®

- Durable black polyester fabric and semi-rigid material that holds its shape, empty or full

2880971 | **\$119<sup>99</sup>**  
FITS ALL STRAIGHT BARS AND PROTAPER® BARS. DOES NOT FIT INDY® 550 AND VOYAGEUR® HANDLEBARS. DOES NOT WORK WITH ROX® RISER (2881410)

**315** CUBIC INCHES

## UNDERSEAT STORAGE

**REAR SEAT BAG** AXYS®

- Front of bag attaches behind seat using Tuflok® fasteners (included)
- Compression-molded semi-rigid material

2881463 | **\$135<sup>99</sup>**  
AXYS® RUSH®, AXYS® SWITCHBACK®, DOES NOT WORK WITH THE FOLLOWING RACKS (2880205, 2880205-458, 2880363-458, 2880362-458)

**310** CUBIC INCHES

**WATERPROOF UNDERSEAT LINER BAG** AXYS®

- Fits inside stock underseat bag
- Perfect when riding in heavy, wet snow or backcountry powder

2882857 | **\$55<sup>99</sup>**  
ALL MY17-19 SBA, MY18-19 SKS 146, MY17-19 VOYAGEUR® 600 144, ALL MY19 INDY® 129

**720** CUBIC INCHES

**BURANDT ADVENTURE UNDERSEAT BAG** AXYS®

- Dual side-access zippers provide access to cargo when bag is installed
- Semi-rigid shell holds its shape, full or empty
- Engineered to withstand extreme riding conditions

2881056 | **\$129<sup>99</sup>**  
ALL MY16-19 AXYS® PRO-RMK®, AXYS® SKS, AXYS® RMK® ASSAULT®

**470** CUBIC INCHES

★ TOP SELLER

BURANDT APPROVED

## TUNNEL STORAGE



WEATHER-RESISTANT LID

ADJUSTABLE VELCRO® DIVIDERS

**1,950**  
CUBIC INCHES



PREMIUM BACKCOUNTRY MOUNTAIN JACKET

FITS OVER THE TOP OF THE PREMIUM BACKCOUNTRY TUNNEL BAG

### LOCK & RIDE PREMIUM BACKCOUNTRY TUNNEL BAG AXYS PRO-RIDE®

- Reinforced high-density EVA compression molding provides high impact resistance and extreme tunnel protection
- Main storage allows for a customized configuration
- Bottom is designed with air flow channel to reduce heat between the tunnel and bag

2881979 | **\$329<sup>99</sup>**  
ALL PRO-RMK®, SKS, RMK®, SKS 146, SWITCHBACK® ASSAULT®, INDY® 144, VOYAGEUR®

### PREMIUM BACKCOUNTRY MOUNTAIN JACKET

2882130 | **\$83<sup>99</sup>**  
ALL PRO-RMK®, SKS, RMK® ASSAULT®, RMK®, SKS 146, SWITCHBACK® ASSAULT®, INDY® 144, VOYAGEUR®, REQUIRES PREMIUM LOCK & RIDE® BACKCOUNTRY TUNNEL BAG (2881979)



SMALL

2" BUCKLES

OVER-CENTER LOCK & RIDE®

**560**  
CUBIC INCHES



LARGE

WEATHER-RESISTANT LID

**900**  
CUBIC INCHES

### LOCK & RIDE BURANDT ADVENTURE TUNNEL BAG AXYS PRO-RIDE®

- 2" buckles provide easy access to gear with your gloves on
- Customizable configuration with Velcro® adjustable dividers

- Tray liner is water-resistant to keep your gear dry

Small | 2880969 | **\$259<sup>99</sup>**  
Large | 2880970 | **\$289<sup>99</sup>**

ALL PRO-RMK®, SKS, RMK® ASSAULT®, SWITCHBACK® SP, SKS 146, SWITCHBACK® ASSAULT®, RMK®, INDY® 144, VOYAGEUR®. LARGE BAG WILL NOT WORK WITH 144" TUNNELS OR FUEL CAN RACKS ON 155" TUNNELS.

### TRAVERSE TUNNEL BAG **NEW**

- 2" buckles make it easy to access your gear with gloves on
- Water-resistant construction
- Attaches in seconds with Lock & Ride® technology

2883570 | **\$259<sup>99</sup>**  
FITS ALL FULL TUNNEL 129" AND LONGER SLEDS WITH T-SLOT ATTACHMENT



★ TOP SELLER

SMALL

**560**  
CUBIC INCHES



**750**  
CUBIC INCHES

LARGE

### LOCK & RIDE ULTIMATE SHOVEL BAG AXYS PRO-RIDE®

- Semi-rigid compression-molded material
- Mesh pocket inside exterior shell
- Customize interior with adjustable Velcro® dividers
- Holds secondary shovel head, handle, and

- essential extra gear (sold separately)
- Shovel sold separately

Small | 2881057 | **\$284<sup>99</sup>**

Large | 2882822 | **\$349<sup>99</sup>**  
ALL PRO-RMK®, SKS, RMK® ASSAULT®, SWITCHBACK® SP, SKS 146, SWITCHBACK® ASSAULT®, RMK®, INDY® 144, VOYAGEUR®, LARGE BAG WILL NOT WORK WITH 144" TUNNELS OR FUEL CAN RACKS ON 155" TUNNELS

### LOCK & RIDE HARDWARE REPLACEMENT

- Sold individually

2881260 | **\$22<sup>49</sup>**  
ALL AXYS® & PRO-RIDE®



### SEMI-RIGID TUNNEL BAGS

AXYS PRO-RIDE®

- Heavy-duty nylon; water-resistant
- Mounts quickly and easily on tunnel

2880607 | **\$119<sup>99</sup>**  
MY13-19 PRO-RIDE® CHASSIS INDY®



### SNOBUNJE® RATTLER

- Deep snow extraction device
- Hook attaches to ski; use handle to pull

2874420 | **\$103<sup>59</sup>**

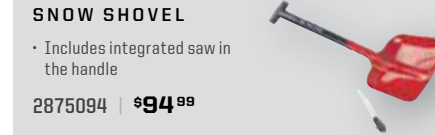

### SNOW SHOVEL

- Includes integrated saw in the handle

2875094 | **\$94<sup>99</sup>**



### 240CM AVALANCHE PROBE

2874916 | **\$94<sup>99</sup>**

### SNOWBOARD & SKI RACK

AXYS PRO-RIDE®

- Multi-use for ski to snowboard applications via brackets
- Minimalist design usage allows room for tunnel bag, backpack, or gas can rack

- Versatile rack allows ability to install on either side of the tunnel

2881251 | **\$389<sup>99</sup>**  
ALL PRO-RMK®, SKS, RMK® ASSAULT®, VOYAGEUR® 155



### LOCK & RIDE ADJUSTABLE FUEL CAN RACK

AXYS PRO-RIDE®

- Installs quickly and easily in tunnel's T-slots
- Holds most 2.5 gal. fuel cans
- Fuel can sold separately; not through Polaris®

Aluminum | 2879790 | **\$135<sup>99</sup>**

Matte Black | 2879790-458 | **\$135<sup>99</sup>**

ALL PRO-RMK®, SKS, RMK® ASSAULT®, RMK®, SWITCHBACK® ASSAULT®, INDY® 144, VOYAGEUR® DOES NOT FIT WITH LARGE BURANDT ADVENTURE BAG (2880970) ON 155" TUNNELS.

### FUEL CAN RACK STRAPS

7081248 | **\$10<sup>49</sup>**  
AXYS® AND PRO-RIDE®

## PRO-RIDE® INDY®



NEW

### INDY EVO™ TUNNEL STORAGE BAG

- Provides underseat storage for quick access
- Compression molded design provides rigidity
- Attaches easily with all-weather Velcro® strips

2883671 | **\$129<sup>99</sup>**  
MY19 INDY EVO™



### HANDLEBAR BAG

- Provides quick, convenient access to essential items
- Semi-rigid design retains its shape even when empty
- Attaches easily with all-weather Velcro® strips

2882829 | **\$83<sup>99</sup>**  
MY13-19 INDY®, MY13-19 INDY® SP, MY14-19 INDY® ES



### LOCK & RIDE TUNNEL BAG

- Tunnel-top storage provides storage for larger items including clothing and gloves
- Semi-rigid design retains its shape even when empty
- Large zippered opening delivers easy storage access

2882788 | **\$129<sup>99</sup>**  
MY13-MY19 INDY®, MY13-MY19 INDY® SP, MY14-MY19 INDY® ES



### UNDERSEAT BAG

- Take advantage of underseat space with this easy-access storage bag
- Semi-rigid design retains its shape even when empty
- Attaches easily with all-weather Velcro® strips

2882786 | **\$84<sup>99</sup>**  
MY13-MY19 INDY®, MY13-MY19 INDY® SP, MY14-MY19 INDY® ES



# SWITCHBACK® CARGO RACK

AXYS®

- Strong, durable aluminum construction
- Easy bolt-on installation; all mounting hardware included

Aluminum | 2880205 | **\$314<sup>99</sup>**

Matte Black | 2880205-458 | **\$299<sup>99</sup>**

SWITCHBACK® ADVENTURE™ '19, MY15-19 SWITCHBACK® 137

**30**  
LBS STORAGE



## SWITCHBACK® CARGO RACK BAG OPTIONS



### CARGO RACK BAG

Weather-resistant design helps seal out snow and moisture to keep cargo dry. Durable, semi-rigid, compression-molded design resists impacts.

2881967 | **\$239<sup>99</sup>**  
MY15-19 SWITCHBACK® 137. (REQUIRES RACK 2880205 OR 2880205-458)



**1,360**  
CUBIC INCHES



### UNDERSEAT ESSENTIALS BAG

Holds goggles, gloves, water bottle, and more. Durable, semi-rigid, compression-molded design resists impacts.

2880373 | **\$135<sup>99</sup>**  
MY15-19 AXYS® RUSH® 120 & SWITCHBACK® 137

**330**  
CUBIC INCHES



### X2 BACKREST CARGO RACK BAG

Weather-resistant design helps seal out snow and moisture to keep cargo dry. Durable, semi-rigid, compression-molded design resists impacts.

2881966 | **\$169<sup>99</sup>**  
MY15-19 SWITCHBACK® 137. (REQUIRES RACK 2880205 OR 2880205-458)



**640**  
CUBIC INCHES



### SOFT SADDLEBAGS

Expand your storage options with soft-sided saddlebags. Semi-rigid design retains its shape even when empty. Large zippered opening delivers easy storage access. Attaches quickly and securely with all-weather Velcro® strips.

2882094 | **\$129<sup>99</sup>**  
MY15-19 SWITCHBACK®, REQUIRES SWITCHBACK® CARGO RACK (2880205 OR 2880205-458)

**440**  
CUBIC INCHES



### UNDERSEAT JOURNEY BAG

Front of bag attaches behind seat using Tuflok® fasteners (included). Center cargo compartment and two side compartments. Durable, semi-rigid, compression-molded design resists impacts.

2880372 | **\$199<sup>99</sup>**  
MY15-19 AXYS® RUSH® 120 & SWITCHBACK® 137



**660**  
CUBIC INCHES



### LOCK & RIDE CARGO RACK SADDLEBAGS

Impact-modified nylon shell and water-resistant removable liner for underseat cargo bag.

2878720 | **\$494<sup>99</sup>**  
MY15-19 AXYS® SWITCHBACK® 137 (REQUIRES RACK 2880205 OR 2880205-458)



### REAR SPORT RACK AXYS®

- Easy bolt-on installation; all mounting hardware included

Matte Black | 2880362-458 | **\$135<sup>99</sup>**  
MY15-19 RUSH®

Matte Black | 2880363-458 | **\$135<sup>99</sup>**  
MY15-19 SWITCHBACK® 137



### CARGO RACK 144" AXYS® PRO-RIDE®

- Design offers three-level storage: Cross bars low, medium, and high
- Angled design accommodates tie-down straps to secure cargo

Matte Black | 2881940-458 | **\$189<sup>99</sup>**

MY17-19 AXYS® 144, MY18-19 SKS, ALL 550 AND 600 VOYAGEUR® MODELS

## BAG OPTION



### SPORT RACK BAG

Bag attaches to rack and behind seat using Tuflok® fasteners. Durable, semi-rigid, compression-molded design resists impacts.

2881464 | **\$234<sup>99</sup>**  
AXYS® RUSH® 120 & SWITCHBACK® 137

**950**  
CUBIC INCHES

## BAG OPTION



### CARGO BAG 144"

Semi-compressed with nylon side bag installs securely in cargo rack. Versatile bag can be converted to a single large cargo compartment.

2881968 | **\$169<sup>99</sup>**  
MY17-19 AXYS® 144, MY18-19 SKS 146, ALL 550 AND 600 VOYAGEUR® MODELS (REQUIRES CARGO RACK 2881940 OR 2881940-458)

TUNNEL CAPACITY VARIES. PLEASE SEE DECAL ON TUNNEL FOR YOUR VEHICLE'S SPECIFICATIONS



### FT2 UNDER RACK BAG **NEW**

- Easy access with weather-resistant zipper
- Compression-molded design provides rigidity
- Attaches directly to rack with all-weather Velcro®

2883714 | **\$194<sup>99</sup>**  
MY19 INDY® XC 129, MY19 INDY® SP 129, MY17-19 SWITCHBACK® ASSAULT®, MY18-19 144 VOYAGEUR® (REQUIRES FT2 REAR SEAT RACK (2883646))

### FT2 REAR SEAT RACK **NEW**

- Attaches in seconds with Lock & Ride® technology
- Made of powdercoated high-quality steel

2883646 | **\$259<sup>99</sup>**  
ALL FULL TUNNEL AXYS® 129 AND 144 SLEDS (REQUIRES 2883638 TO INSTALL THE FT2 RACK ON THE MY17-19 VOYAGEUR® 600)

# TITAN

## A LOCK & RIDE VERSA REAR CARGO RACK

- Rugged aluminum powder-coated rear rack delivers versatile storage solutions
- Bolts securely to tunnel and features multiple cargo tie-down points

2882792 | **\$259<sup>99</sup>**  
ALL TITAN™



### STORAGE OPTIONS

## B LOCK & RIDE VERSA REAR CARGO BOX

- Heavy-duty roto-molded box mounts to accessory rear luggage rack with Lock & Ride™ technology
- Easy-open hinge lid can accommodate an optional padlock for security
- A total of 16 gallons of storage space

2882793 | **\$324<sup>99</sup>**  
ALL TITAN™



## C LOCK & RIDE UNDER-PASSENGER SEAT BAG

- Take advantage of underseat space with this easy-access storage bag
- Semi-rigid design retains its shape even when empty
- Attaches easily with Velcro™ strips

2882807 | **\$169<sup>99</sup>**  
DOES NOT WORK WITH VERSA REAR CARGO BOX 2882783.  
RECOMMENDED WITH VERSA TOURING PASSENGER SEAT 2882791.

NEED MORE STORAGE FOR YOUR AXYS™ SLED? SEE STORAGE OPTIONS FOR WINDSHIELD & HANDLEBAR BAGS ON P. 58-59

## GUN & ROD MOUNT

- Versatile and rugged mount affixes to side of tunnel
- Conveniently accepts accessory gun boots or ice rod lockers
- Retains storage capabilities of rear rack

» Kolpin® Stronghold Mount  
2882806 | **\$194<sup>99</sup>**  
ALL TITAN™

» Gun Scabbard by Kolpin®  
2882426 | **\$94<sup>99</sup>**  
ALL TITAN™

» Ice Rod Locker  
2882428 | **\$114<sup>99</sup>**  
ALL TITAN™



## HITCHES

### STANDARD HITCH

2882812 | **\$109<sup>99</sup>**  
ALL TITAN™

### 1.25" RECEIVER

2882795 | **\$109<sup>99</sup>**  
ALL TITAN™

### BALL HITCH

- Allows customer to use any size ball with ¾" shank
- Requires 1.25" receiver (2882795)
- Ball not included

2882813 | **\$109<sup>99</sup>**  
ALL TITAN™

## HITCH ADAPTER

- Bolts onto either the J-hook or Standard hitch to allow them to be used with 1.25" receiver installed
- Allows user to change between J-hook, Standard, and Ball hitch without the use of tools

2882814 | **\$69<sup>99</sup>**  
ALL TITAN™

## ICE AUGER RACK

- Premium steel rack securely holds your ice auger for easy transport

2882799 | **\$219<sup>99</sup>**  
ALL TITAN™



## INTEGRATED 1500LB WINCH

- Versatile and rugged winch can clear downed trees or retrieve a stuck snowmobile
- Features a powerful 1,500 lbs towing capacity
- Mounts to rear of sled with included receiver hitch
- Includes wireless winch remote
- Mounts to front of sled when using Titan™ HD Front Bumper (2882794). (Requires 2883850)

2882798 | **\$1,034<sup>99</sup>**  
ALL TITAN™

### TITAN™ FRONT WINCH ATTACHMENT CABLE

- Required for utilization of the winch in the front of your Polaris® Titan™ snowmobile. Requires Titan™ HD Front Bumper (2882794)

2883850 | **\$69<sup>99</sup>**



## VOYAGEUR® 155" EXTREME REAR RACK

- Strong, durable tubular construction
- Easy bolt-on installation

2880275 | **\$299<sup>99</sup>**  
550 INDY® VOYAGEUR® 155

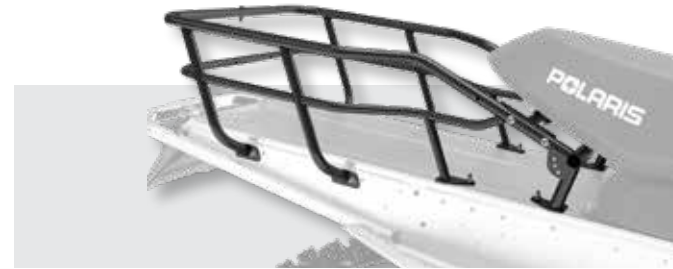

### BAG OPTION



## EXTREME REAR BAG

Durable polyester shell engineered to withstand extreme riding conditions. Easy installation with strong Velcro™ straps. Bag has multiple cargo compartments with zippered closures

2881250 | **\$234<sup>99</sup>**



## EXTREME REAR RACK LINER

Strong, durable plastic construction

2880478 | **\$189<sup>99</sup>**  
550 INDY® VOYAGEUR® 155  
(REQUIRES RACK 2880275)

## ADVENTURE CARGO RACK

- Strong, durable aluminum
- Installs securely; six fasteners in tunnel T-slots

- Stock rack can be added as rack extension
- All mounting hardware included

Brushed Aluminum  
2879846 | **\$179<sup>99</sup>**  
550 INDY® VOYAGEUR® 144,  
550 INDY® VOYAGEUR® 155



### ADVENTURE CARGO RACK BAG



## LOCK & RIDE REAR RACK BAG

Compression-molded plastic with zippered closure and zippered expansion panel

2878731 | **\$119<sup>99</sup>**  
550 INDY® VOYAGEUR® 144,  
550 INDY® VOYAGEUR® 155  
(REQUIRES RACK 2879846)

**880**  
CUBIC INCHES

## HITCHES

### RECEIVER/HITCH COMBOS



### RECEIVER

2878344 | **\$169<sup>99</sup>**  
INDY® 144 & VOYAGEUR® 144

2879236 | **\$169<sup>99</sup>**  
INDY EVO™ '19, INDY® 121 MY13-19

2875118 | **\$194<sup>99</sup>**  
MY11 RMK®, MY11-16 RMK® 144,  
MY11-16 SWITCHBACK® ASSAULT®,  
MY14-16 INDY® VOYAGEUR® 144

2880369-458 | **\$169<sup>99</sup>**  
MY15-19 RUSH®, MY15-19  
SWITCHBACK® 137

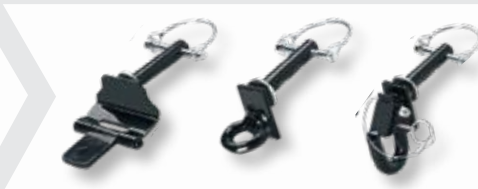

★ TOP SELLER

### STANDARD HITCH

2876677 | **\$48<sup>99</sup>**

SLEDS WITH RECEIVER HITCH INSTALLED (2878344, 2879236, 2875118 & 2880369-458)

### DONUT HITCH

2874449 | **\$55<sup>99</sup>**

### HEAVY-DUTY "J" HITCH

2879838 | **\$135<sup>99</sup>**

### STAND-ALONE HITCHES



### STANDARD

2882859 | **\$209<sup>99</sup>**  
ALL AXYS® 129, 144, 146 SLEDS



### J-HOOK

2882915 | **\$249<sup>99</sup>**  
ALL AXYS® 129, 144, 146 SLEDS

2882918 | **\$169<sup>99</sup>**  
MY17-19 AXYS® VOYAGEUR®  
600 144

2882790 | **\$169<sup>99</sup>**  
MY15-19 VOYAGEUR® 550 155,  
MY15-19 INDY® 550 155

# SEATS

**LOCK & RIDE** **NEW**  
**LOCK & RIDE® FT2 PASSENGER SEAT**

- Installs/removes easily in seconds with Lock & Ride® technology
- Enhances driver and passenger comfort
- Includes backrest, seat, and handholds
- Heated grips & plug in for passenger's heated visor
- Requires FT2 Rear Seat Rack (2883646) P. 63

2883637 | **\$839<sup>99</sup>**

INDY® XC 129 '19, INDY® SP 129 '19, MY17-19 SWITCHBACK® ASSAULT®, ALL MY18-19 144 VOYAGEUR®, ALL AXYS® 129 144 & 146

**HANDWARMER KIT**

- Required to power the passenger handwarmers on MY17-18 AXYS® 144 sleds
- 2883851 | **\$69<sup>99</sup>**  
 MY17-18 144 AXYS®

**VOYAGEUR® 144 BRAKE LIGHT SUPPORT KIT**

2883838 | **\$69<sup>99</sup>**  
 ALL AXYS® VOYAGEUR® 144



**LOCK & RIDE** **AXYS**  
**X2 BACKREST WITH HANDHOLDS**

- Enhance passenger comfort and confidence
- Heated handholds
- Provides passenger with comfortable backrest
- X2 Seat and Cargo Rack each sold separately

2881164 | **\$839<sup>99</sup>**

AXYS® SWITCHBACK®, AXYS® SWITCHBACK ADVENTURE®, REQUIRES AXYS® X2 PASSENGER SEAT (2880378). REQUIRES AXYS® CARGO RACK (2880205 OR 2880205-458). DOES NOT WORK WITH THE AXYS® RACK BAG (2880376)



SECURE COMFORT BACKREST

HEATED HANDHOLDS

**X2 PASSENGER SEAT**

- Quick and easy installation; includes mounting hardware and heavier rear spring

2880378 | **\$559<sup>99</sup>**  
 AXYS® SWITCHBACK®, AXYS® SWITCHBACK ADVENTURE®, \*REQUIRES AXYS® CARGO RACK (2880205 OR 2880205-458)

**LOCK & RIDE**  
**X2 SEAT BACKREST**

- Enhances passenger comfort and security

2880377 | **\$389<sup>99</sup>**  
 AXYS® SWITCHBACK®, AXYS® SWITCHBACK ADVENTURE®, \*REQUIRES AXYS® CARGO RACK (2880205 OR 2880205-458). DOES NOT WORK WITH THE AXYS® RACK BAG (2880376). USE SWITCHBACK®, WATER-RESISTANT REAR RACK BAG (2878731)



**NEW**

**PASSENGER GAUNTLET**

2883573 | **\$155<sup>99</sup>**  
 VERSA TOURING PASSENGER SEAT & FT2 PASSENGER SEAT

**LOCK & RIDE**  
**VERSA TOURING PASSENGER SEAT**

- Attaches/removes in seconds with Lock & Ride® technology
- Heated version available
- Includes heated hand grips and connection for heated visor on full-face helmets
- Requires Versa Rear Cargo Rack (2882792)

Standard | 2882791 | **\$839<sup>99</sup>**

Heated | 2882801 | **\$1,034<sup>99</sup>**  
 ALL TITAN™



CONDUCTIVE HEAT

**HEATED SEAT** **AXYS**

- Keep warm during the most demanding winter rides
- Features easy to use high/low/off switch for complete control
- Complete seat assembly with all mounting hardware and harness

Black | 2882819 | **\$494<sup>99</sup>**

ALL MY15-19 RUSH®, MY15-19 SWITCHBACK®, MY18-19 SKS 146, 144 RMK® 144, VOYAGEUR® 600 MY17-19, 129 XC 129, SP 144 INDY® SP MY19



**POLARIS® TITAN™ HEATED SEAT**

- Keep warm during the most demanding winter rides
- Features easy to use high/low/off switch for complete control
- Complete seat assembly with all mounting hardware and harness

Black | 2882747 | **\$494<sup>99</sup>**  
 ALL TITAN™

**LOCK & RIDE** **PRO-RIDE**  
**CONVERTIBLE PASSENGER SEAT**



- Accommodates passenger and cargo up to 150 lbs./68 kg.

2879839 | **\$769<sup>99</sup>**

VOYAGEUR® '19, INDY® SP 144 '19, INDY® LXT '19, INDY® ADVENTURE '19, INDY® 144 '19, INDY® '18

**B CONVERTIBLE PASSENGER SEAT BACKREST**

- Enhances passenger comfort
- Attaches securely to seat

2879841 | **\$209<sup>99</sup>**  
 MY11-19 VOYAGEUR®, MY11-19 INDY® SP 144, MY11-19 INDY® LXT, MY11-19 INDY® ADVENTURE, MY11-19 INDY® 144

**C HEATED GRIPS**

- Enhances passenger comfort
- Powered by sled's electrical system

2879840 | **\$119<sup>99</sup>**  
 MY11-19 VOYAGEUR®, MY11-19 INDY® SP 144, MY11-19 INDY® LXT, MY11-19 INDY® ADVENTURE, MY11-19 INDY® 144

**D 2-UP TOURING KIT**

- Enhances driver and passenger comfort
- Includes backrest, seat, and handholds

2878157 | **\$454<sup>99</sup>**  
 VOYAGEUR®, INDY® 144. REQUIRES 2-UP TOURING CARGO RACK (2878156)

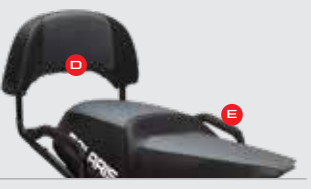

**E PASSENGER HANDWARMER KIT**

- Provides a passenger's hands with heat
- Heater control includes multiple heat settings, including OFF

2878201 | **\$76<sup>99</sup>**  
 VOYAGEUR®, INDY® 144. \*REQUIRES VOYAGEUR® 2-UP TOURING CARGO RACK (2878156) OR VOYAGEUR® 155. EXTREME REAR RACK (2880275); BOTH SOLD SEPARATELY



**COLORED SEAT SUPPORT** **AXYS**

- Same construction as stock seat support for perfect fit
- Finish is color-matched to Polaris® graphics and resists chipping and wear

Red	2881438-293
Black	2881438-458
Lime Squeeze	2881438-630
Orange	2881438-647
Blue	2881438-689
Matte Gold Metallic	<b>NEW</b> 2881438-703
Sky Blue	<b>NEW</b> 2881438-737
ALL MY16-18 AXYS® PRO-RMK®, RMK® ASSAULT® & SKS	<b>\$109<sup>99</sup></b>



**KIT-LIGHTWEIGHT RMK® SEAT**

2879089 | **\$69<sup>99</sup>**  
 MY11-19 PRO-RMK®, RMK® ASSAULT® & SKS



**PASSENGER FOOTRESTS** **AXYS**

- Add passenger comfort and security with passenger footrests
- Extruded aluminum design attaches directly to running board

Matte Black | 2882797 | **\$194<sup>99</sup>** ALL TITAN™  
 Raw | 2882817 | **\$194<sup>99</sup>** FITS AXYS® SWITCHBACK® 137  
**NEW** Raw | 129/144 | 2883571 | **\$194<sup>99</sup>**  
 MY19 INDY® XC 129, MY19 INDY® SP 129, MY17-19 SWITCHBACK® ASSAULT®, ALL AXYS® 129 144 & 146

# WINDSHIELDS



Blend protection and style and find your ideal sightline



## LOW WINDSHIELD

AXYS	
Black / Gray	2880385
White / Black	2880386
Red / White	2880387
Blue / White	2881244
Orange / Black	2881245
White	2882062
Lime Squeeze	2882826
ALL AXYS® AND POLARIS® TITAN® COMBINE WITH AXYS® LOW WINDSHIELD BAG (2880481, P. 58)	<b>\$109<sup>99</sup></b>

## DEEP SNOW MID WINDSHIELD

AXYS		
Blue	2881053	<b>\$144<sup>99</sup></b>
White	2881054	<b>\$144<sup>99</sup></b>
Matte Black	2881055	<b>\$144<sup>99</sup></b>
Red	2881436	<b>\$144<sup>99</sup></b>
Gloss Black	2882058	<b>\$135<sup>99</sup></b>
ALL AXYS® AND POLARIS® TITAN® COMBINE WITH AXYS® WINDSHIELD BAG (2880374 ON PG. 58)		

## FLATLAND MID WINDSHIELD

AXYS		
Clear	2880389	<b>\$139<sup>99</sup></b>
Gloss Black	2880390	<b>\$144<sup>99</sup></b>
White	2880391	<b>\$144<sup>99</sup></b>
Red	2880392	<b>\$144<sup>99</sup></b>
ALL AXYS® AND POLARIS® TITAN®		



## TALL WINDSHIELD

AXYS	
Smoke	2880394
ALL AXYS® AND POLARIS® TITAN®	<b>\$154<sup>99</sup></b>

## EXTRA TALL WINDSHIELD

AXYS	
Clear	2883078
ALL AXYS® AND POLARIS® TITAN®	<b>\$169<sup>99</sup></b>



## FULL COVERAGE WINDSHIELD

AXYS	
Clear	2882796
ALL AXYS® AND POLARIS® TITAN®	<b>\$194<sup>99</sup></b>



## LOW WINDSHIELD

PRO-RIDE	
Black	2878779
White	2879097
ALL PRO-RIDE®	<b>\$104<sup>99</sup></b>

## MID WINDSHIELD

PRO-RIDE	
Smoke	2877841
Matte Black	2879828
White Gloss	2879829
ALL PRO-RIDE®	<b>\$135<sup>99</sup></b>

## WIDE WINDSHIELD

PRO-RIDE	
Clear	2878512
ALL PRO-RIDE®	<b>\$154<sup>99</sup></b>

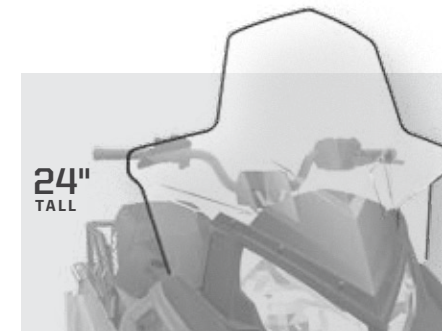

## EXTRA-WIDE TALL WINDSHIELD

PRO-RIDE	
Clear	2879156
ALL PRO-RIDE®	<b>\$154<sup>99</sup></b>



## WIND DEFLECTORS

PRO-RIDE	
Clear	2879156
ALL PRO-RIDE®	<b>\$48<sup>99</sup></b>

- Rubber deflectors with adhesive backing
- Set of two
- Flared edge deflects wind, snow, and ice



# FIND YOUR PERFECT SIGHTLINE

Blend protection and style with the windshield built just for the type of riding you do most.

**TALL**

The choice when you want maximum wind protection. Perfect for riders who ride in colder conditions often.

**MID**

The best of both worlds: a clean look for your sled that also offers wind protection for colder days.

**LOW**

For a sleek, clean look on your sled. Does not affect vision in any way. Great for riders who stand up most of the time.

# BUMPERS

## FRONT BUMPERS

**NEW**

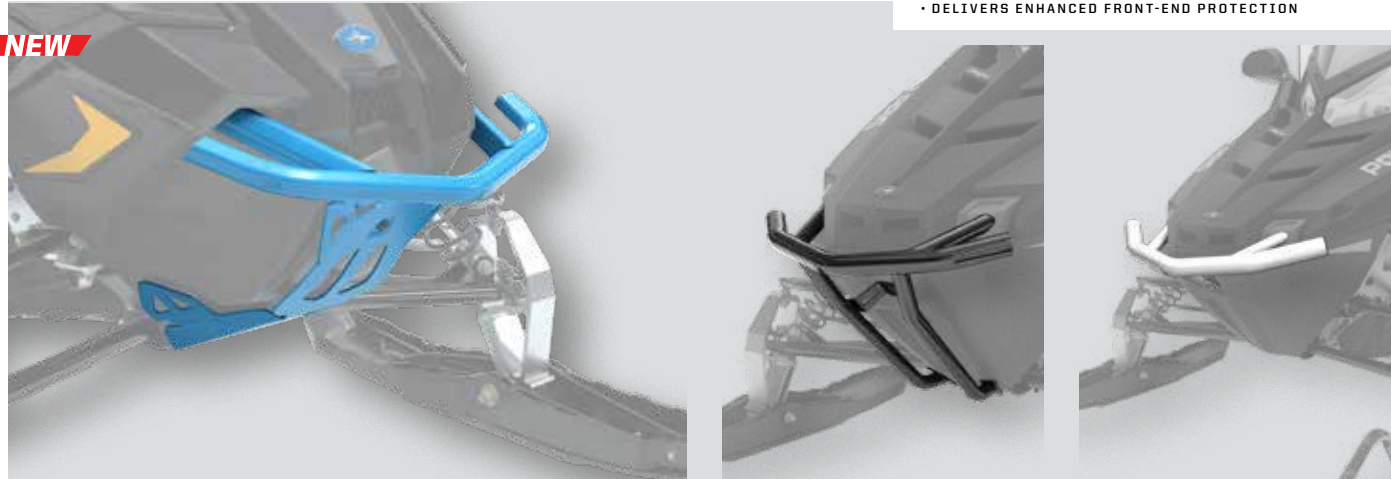

• DELIVERS ENHANCED FRONT-END PROTECTION

PROTECTION: MAXIMUM

PROTECTION: MAXIMUM — MEDIUM

### MONARCH AXYS™

White	2883681-133	Orange	2883681-647
Red	2883681-293	Blue	2883681-689
Matte Black	2883681-458	Matte Gold Metallic <b>NEW</b>	2883681-703
Lime Squeeze	2883681-630	Sky Blue <b>NEW</b>	2883681-737
ALL AXYS™		<b>\$234<sup>99</sup></b>	

### ULTIMATE PRO-RIDE™

Aluminum	2879727
White	2879727-133
Matte Black	2879727-458
ALL PRO-RIDE™. INCLUDES INDY® & VOYAGEUR™. WILL NOT FIT WITH ANY SKID PLATE	
<b>\$224<sup>99</sup></b>	

### EXTREME PRO-RIDE™

Aluminum	2878688
White	2878688-133
Matte Black	2878688-458
ALL PRO-RIDE™. INCLUDES INDY® & VOYAGEUR™	
<b>\$164<sup>99</sup></b>	



POLARIS  
**TITAN**

Keep brush at bay and protect the front end of your TITAN™ with the TITAN HD Front Bumper. Features an integrated front-facing winch mount, black powder coating, and high-strength steel construction.



**NEW**

Includes 1.25" hitch receiver

PROTECTION: MAXIMUM

### HD FRONT BUMPER

Black	2882794
ALL TITAN™	<b>\$359<sup>99</sup></b>

### TITAN™ LIGHTBAR MOUNT

2882815 | **\$109<sup>99</sup>**  
ALL TITAN™  
FITS LIGHTBARS 2882313 OR 2882078 (NOT INCLUDED)

### TITAN™ REAR BUMPER HANDLES

• Convenient rear grab points for your Polaris® Titan™

2882803 | **\$83<sup>99</sup>**  
ALL TITAN™

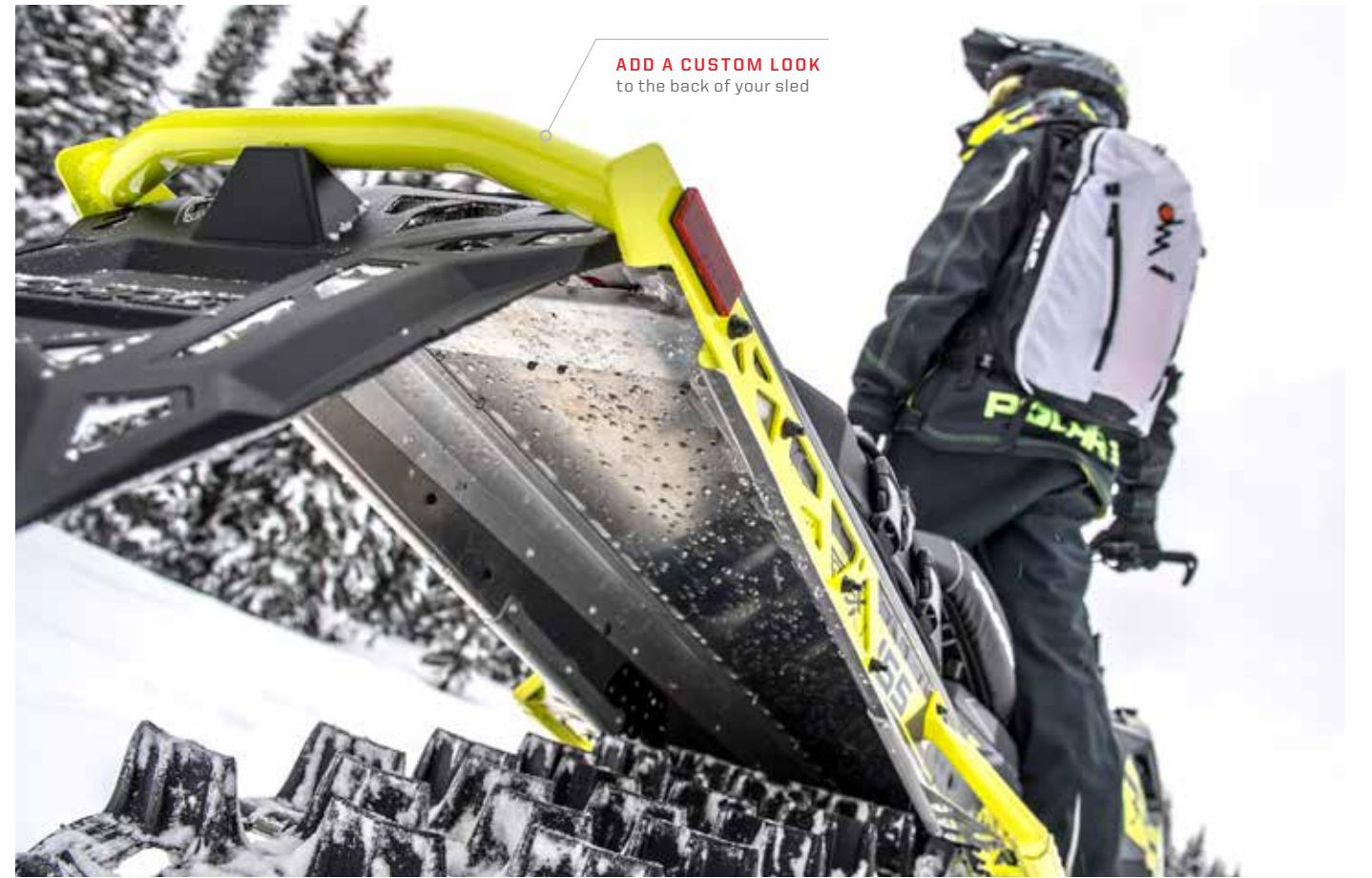

ADD A CUSTOM LOOK to the back of your sled

## REAR BUMPERS

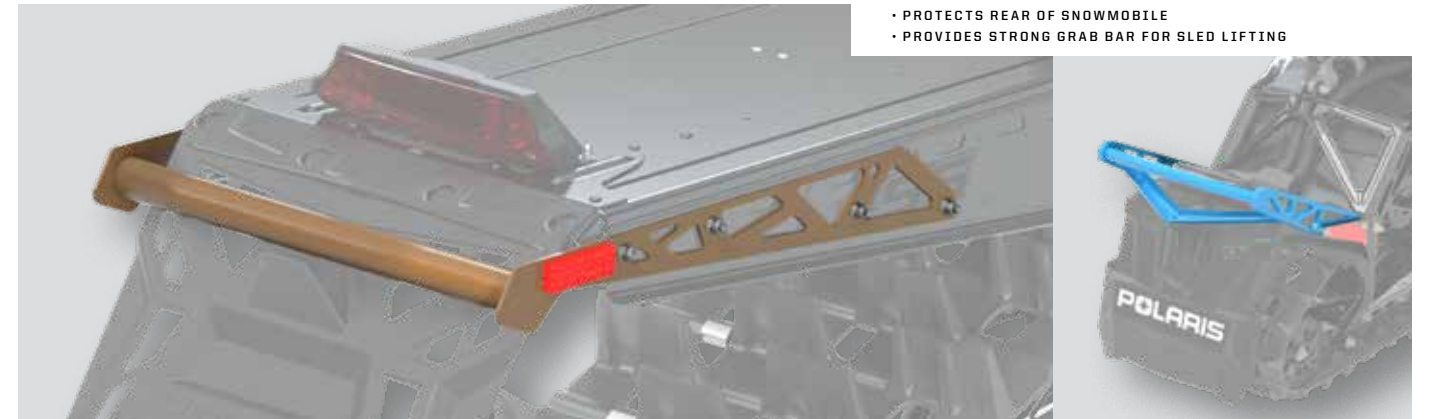

• PROTECTS REAR OF SNOWMOBILE  
• PROVIDES STRONG GRAB BAR FOR SLED LIFTING

### EXTREME 144" // 155"/163" // 174" AXYS™

COLORS	144"	155"/163"	174"
White	2881941-133	2880993-133	2881754-133
Red	2881941-293	2880993-293	2881754-293
Black	2881941-458	2880993-458	2881754-458
Lime Squeeze	2881941-630	2880993-630	2881754-630
Orange	2881941-647	2880993-647	2881754-647
Blue	2881941-689	2880993-689	2881754-689
Matte Gold Metallic <b>NEW</b>	2881941-703	2880993-703	2881754-703
Sky Blue <b>NEW</b>	2881941-737	2880993-737	2881754-737

### ELITE PRO AXYS™

White	2882926-133
Red	2882926-293
Black	2882926-458
Lime Squeeze	2882926-630
Orange	2882926-647
Blue	2882926-689
Matte Gold Metallic <b>NEW</b>	2882926-703
Sky Blue <b>NEW</b>	2882926-737

144" FITMENT: MY17-19 SWITCHBACK® ASSAULT™, MY17-19 SWITCHBACK® SP, MY17-19 600 VOYAGEUR™, MY17-19 RMK® 144. 155"/163" FITMENTS: ALL MY16-19 AXYS® PRO-RMK®, RMK® ASSAULT®, AND SKS 155"/163" SLEDS. 174" FITMENT: MY17-19 PRO-RMK® 174

**\$194<sup>99</sup>**  
MY15-19 RUSH™, MY15-19 SWITCHBACK®, DOES NOT FIT SWITCHBACK® ASSAULT™

# RUNNING BOARDS



Give your foothold a customized look with factory-matched running board options

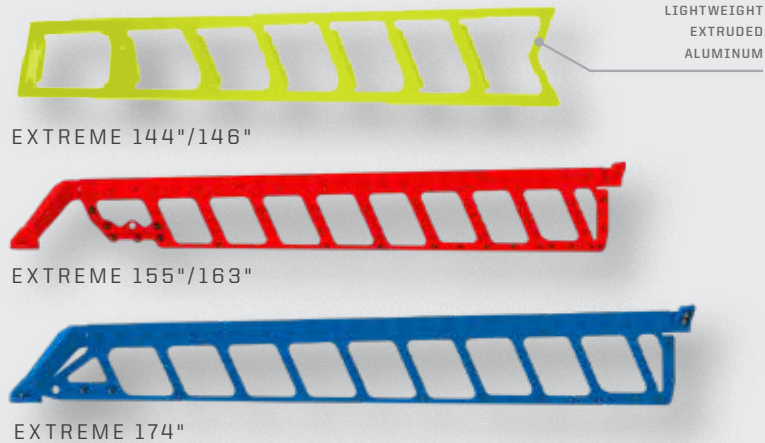

LIGHTWEIGHT EXTRUDED ALUMINUM

EXTREME 144"/146"

EXTREME 155"/163"

EXTREME 174"

## EXTREME 144"/146" // 155"/163" // 174" **AXYS**

- Design optimizes snow extrusion to prevent ice buildup for optimal rider control and performance
- Secure front and rear attachment with factory-bonded castings
- Removable and serviceable running board assemblies

COLORS	144"/146"	155"/163"	174"
□ Bright White	2881965-133	2881041-133	2881952-133
■ Indy Red	2881965-293	2881041-293	2881952-293
■ Black	2881965-458	2881041-458	2881952-458
■ Lime Squeeze	2881965-630	2881041-630	2881952-630
■ Spectra Orange	2881965-647	2881041-647	2881952-647
■ Velocity Blue	2881965-689	2881041-689	2881952-689

144"/146" FITMENTS: MY17-19 SWITCHBACK® ASSAULT®, MY17-19 SWITCHBACK® SP, MY17-19 600 VOYAGEUR®, MY17-19 RMK® 144, MY18-19 SKS 146. 155"/163" FITMENTS: 155" A6 163" AXYS® PRO-RMK®, RMK® ASSAULT®, 6 SKS. 174" FITMENTS: MY17-19 PRO-RMK® 174 **\$419<sup>99</sup>**

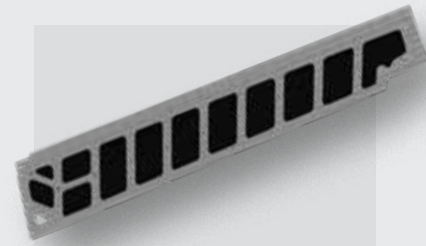

## RUNNING BOARD CLOSE-OUT PLATES

- Aids in water and slush protection when riding in wet conditions
- Premium polyethylene design delivers lightweight protection

2882810 | **\$69<sup>99</sup>**  
ALL TITAN™



## TAILLIGHT GUARD

- Protect the top housing of your taillight from stowed gear or accessories
- Rugged aluminum construction secures directly to the rear cargo platform

2882809 | **\$84<sup>99</sup>**  
ALL TITAN™

# SKID PLATES

- PROTECTS SUSPENSION AND BULKHEAD
- MADE OF STRONG 1/4" UHMW PLASTIC

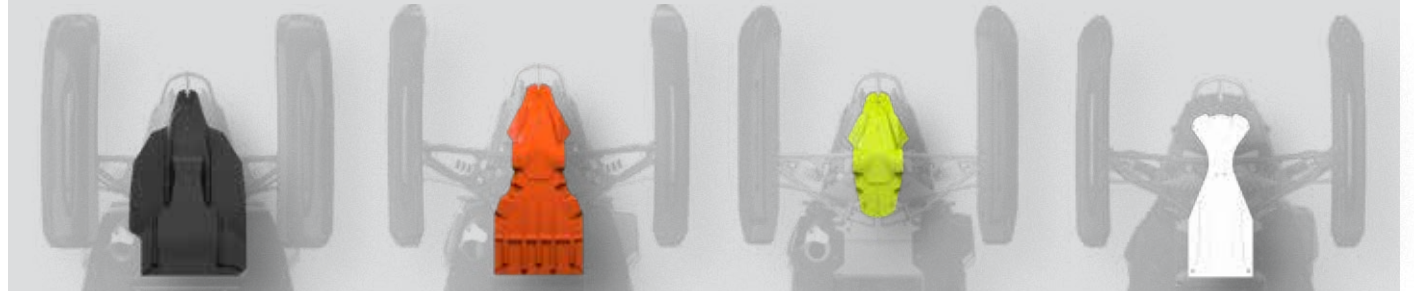

PROTECTION: MAXIMUM — MEDIUM — STANDARD

## HIGH COVERAGE **AXYS**

- Provides the greatest amount of underbelly protection
- Gives a completed and customized look
- Rugged and lightweight UHMW material
- Please note, this may hinder deep snow performance

■ Black 2882748-070  
ALL AXYS® & POLARIS® TITAN™, NOT RECOMMENDED WITH RMK® **\$179<sup>99</sup>**

## ULTIMATE **AXYS**

- Enhances protection of belly pan and bulkhead
- Includes all mounting hardware

■ Black <b>TOP SELLER</b>	2880383-070
□ White	2880383-133
■ Red	2880383-293
■ Blue	2880383-619
■ Lime Squeeze	2880383-630
■ Orange	2880383-647

ALL AXYS® & POLARIS® TITAN™ **\$164<sup>99</sup>**

## EXTREME **AXYS**

- Extended length delivers extra protection for belly pan and bulkhead
- Includes all mounting hardware

■ Black	2880384-070
□ White	2880384-133
■ Red	2880384-293
■ Lime Squeeze	2880384-630
■ Orange	2880384-647
■ Blue	2880384-689

ALL AXYS® & POLARIS® TITAN™ **\$135<sup>99</sup>**

## STANDARD **PRO-RIDE**

- Adds color and custom style
- Includes all mounting hardware

■ Black	2878155-070
□ White	2878155-133
■ Red	2878155-293

MY11-16 SWITCHBACK® ASSAULT®, ALL INDY®, VOYAGEUR® 155 **\$135<sup>99</sup>**



## KNEE PADS

**PRO-RIDE**

2878195 | **\$55<sup>99</sup>**  
ALL PRO-RIDE®



## REAR CRANK FORGING AND SIDE EXTRUSIONS **AXYS**

- Strong, durable forged aluminum and extruded aluminum
- Bolt-on attachment, replaces stock
- Mounting hardware included

2882121-458 | **\$499<sup>99</sup>**  
ALL AXYS®, RUSH®, & SWITCHBACK®, DOES NOT FIT SWITCHBACK® ASSAULT®



## HOODS & PANELS



A FLAIR OF COLOR.  
A TOUCH OF ACCENT.  
**COMPLETE YOUR RIDE.**

Hoods and panels have factory-matched coloring, and are an exact replacement for the stock unit.



### PAINTED HOOD

- Design a one-of-a-kind Polaris® AXYS™ with a colored hood
- Includes all necessary sound and heat shielding
- Hood does not include headlight or decals

 Indy Red	2882131-293
 White	2882131-599
 Lime Squeeze	2882131-630
 Black Pearl	2882131-666
 Velocity Blue	2882131-689





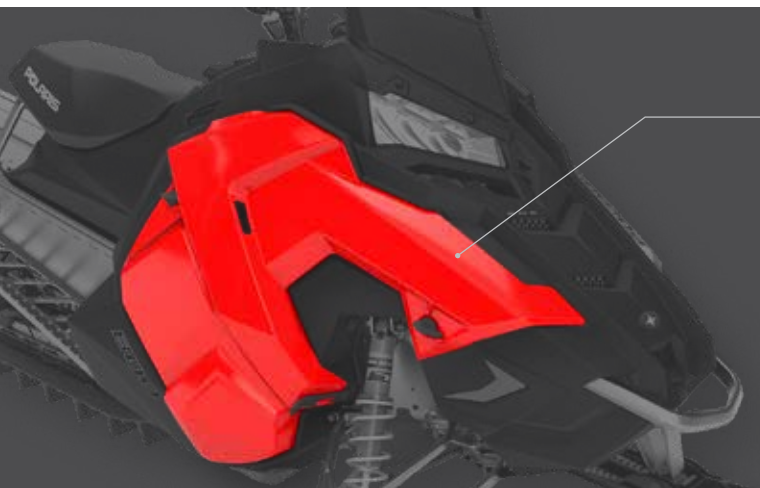





ALL AXYS® AND POLARIS® TITAN™

\$499<sup>99</sup>



### SIDE PANELS

- Design a one-of-a-kind Polaris® AXYS™ with colored side panels
- Panels sold individually and do not include decals

LEFT SIDE PANEL		RIGHT SIDE PANEL	
 Red	5451230-293	 Red	5451231-293
 White	5451230-599	 White	5451231-599
 Orange	5451230-647	 Orange	5451231-647
 Black	5451230-666	 Black	5451231-666
 Blue	5451230-689	 Blue	5451231-689

ALL AXYS® EXCEPT ALL POLARIS® TITAN™. REQUIRES FOAM/FOIL KIT (2635483). DOES NOT INCLUDE QUARTER-TURNS

\$245<sup>99</sup>

## WRAPS



WRAPPING  
YOUR SLED IS  
**EASIER THAN EVER**



It all starts with our innovative Polaris® FX Direct pages and SledWrapR application, which allows you to create a customized look for your sled. Simply find your chassis, select your design, and finalize your colors to make the wrap all your own.



BUILD YOURS NOW:  
[POLARIS.COM/AFXWRAPS](https://www.polaris.com/afxwraps)



# RIDECOMMAND®

## STAY CONNECTED



### SEAMLESSLY ENHANCE YOUR SNOWMOBILING EXPERIENCE

Pair your P.I.D.D. with the revolutionary Ride Command® app and enhance your snowmobiling experience by connecting with your friends and your sled. Ride Command®, when paired with a P.I.D.D., allows you to plan rides and coordinate with friends before, during, and after your ride. Also, get quick-glance access to critical snowmobile diagnostic info and GPS navigation. It enhances the features of your P.I.D.D. and allows you to get even more for your ride.

To download the RIDE COMMAND® APP for free, text SNO1 to 82350

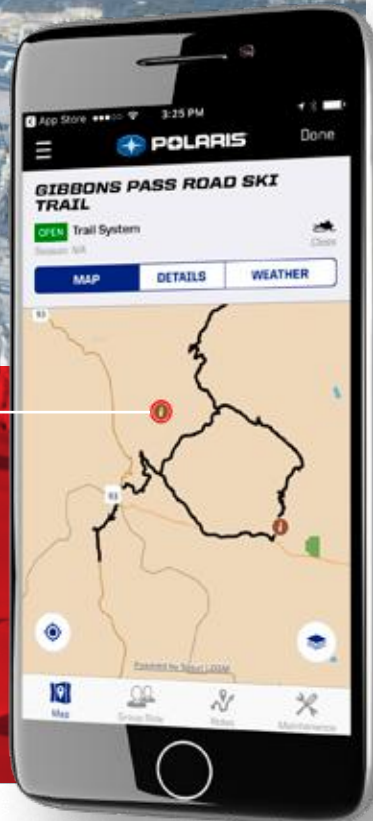

#### CONNECT YOUR DEVICE

- Create a group using the Polaris® Ride Command® app
- Share the snow with fellow riders by inviting a group via social media, text, or email
- Pick a leader in your group to set the "Follow the Leader" feature so you don't get lost on the trail
- Seamlessly enhance your snowmobiling experience



#### CONNECT YOUR FRIENDS

- Track your rides and waypoints, follow your group, and view your vehicle maintenance information
- View the current local weather forecast and snow depth to get ready for your ride



#### CONNECT YOUR SLED

- View trails and update trail maps with the latest 4.3" Polaris® Interactive Digital Display
- Integrates with Polaris® vehicles and the Ride Command® app, giving you the power to monitor and analyze vehicle performance

# P.I.D.D.

POLARIS® INTERACTIVE DIGITAL DISPLAY

## NEVER PULL OUT YOUR MAP AGAIN



### UPGRADE YOUR RIDE EXPERIENCE

STOCK REPLACEMENT & UPGRADE FOR FACTORY DISPLAY

BRIGHTER, EASY-TO-READ SCREEN

AT-A-GLANCE VEHICLE DATA AND DIAGNOSTICS, INCLUDING FAULT CODES

GPS MAPPING WITH ROUTE AND WAYPOINT RECORDING

BLUETOOTH™ FUNCTIONALITY WITH SMARTPHONE CONNECTIVITY

VEHICLE SECURITY FUNCTION

#### POLARIS® INTERACTIVE DIGITAL DISPLAY (P.I.D.D.)

- Bright, easy-to-read 4.3" full-color LCD screen
- GPS Course up or North up option
- GPS Go-to function with distance on map screen
- Exporting capabilities for trip data from the display to USB drive
- TPS, RPM, and ground speed playback for snowmobile tuning, including clutch calibration
- Real-time gauge with speed, RPM, and average MPG
- Phone connectivity shows incoming calls, texts, battery life, and signal
- Toggle through display modes with handlebar control

2881554 | \$1034<sup>99</sup>  
MY15-19 AXYS®, MY10-19 PRO-RIDE® (EXCLUDING 550 MODELS). MUST ORDER INSTALL KIT WITH DISPLAY. REQUIRED PARTS TO INSTALL FOR POLARIS® INTERACTIVE DIGITAL DISPLAY

#### P.I.D.D. INSTALL KIT

AXYS® | 2880493 | \$144<sup>99</sup>  
ALL AXYS® (DOES NOT FIT POLARIS TITAN™)

PRO-RIDE® | 2880495 | \$144<sup>99</sup>  
REQUIRES ULTIMATE DEFROST BAG (2879090)

2883844 | \$144<sup>99</sup>  
ALL POLARIS® TITAN™

### FURTHER ENHANCEMENTS WHEN PAIRED WITH RIDE COMMAND® INCLUDING GROUP RIDE FUNCTION AND LOCAL WEATHER INFORMATION

### DON'T HAVE AN ELECTRIC START?

FOR A BETTER EXPERIENCE WITHOUT ELECTRIC START, INSTALL THE P.I.D.D. POWER UP KIT

#### ADVANTAGES INCLUDE:

- Maintain GPS lock when you start your sled back up (Without battery kit, satellite will need to relocate, which can take up to 30 seconds while moving)
- Display will not shut down and reboot every time your sled is shut off
- Display has ability to run while sled is turned off, which allows you to use the screen while stopped

#### P.I.D.D. POWER UP KIT

2882200 | \$169<sup>99</sup>  
BATTERY SOLD SEPARATELY (4013045) ON P. 79





# HANDLEBARS

## PROTAPER® HANDLEBAR WITH HEATED GRIPS

- ProTaper® handlebar allows riders to customize their handlebar height for their riding style
- Handlebar hooks sold separately (2872482-070)

5" Rise | Black | 2881235 | **\$234<sup>99</sup>**  
 6" Rise | Anodized Gray | 2881236 | **\$234<sup>99</sup>**  
 7" Rise | Silver | 2881237 | **\$234<sup>99</sup>**  
 MY11-19 PRO-RMK®, MY11-19 RMK® ASSAULT®, MY16-19 SKS,  
 MY11-16 PRO-RIDE® SWITCHBACK® ASSAULT®

5" Rise | Black | 2883835 | **\$234<sup>99</sup>**  
 6" Rise | Anodized Gray | 2883836 | **\$234<sup>99</sup>**  
 7" Rise | Silver | 2883837 | **\$234<sup>99</sup>**  
 ALL AXYS® RMK® WITH 850 ENGINE



### HANDLEBAR ACCESSORIES

**MOUNTAIN HOOP**



2882118 | **\$74<sup>99</sup>**  
 ALL STRAIGHT BAR APPLICATIONS

**ROX® ADJUSTABLE BAR RISER**



2881410 | **\$359<sup>99</sup>**  
 ALL AXYS® STRAIGHTBAR APPLICATIONS  
 Increase handle bar height from 2.5" to 4"

**HANDLEBAR HOOK**



2872482-070 | **\$41<sup>99</sup>**  
 DOES NOT FIT PROTAPER® BARS

# HANDGUARDS

## POLARIS® HANDGUARDS

- Durable, impact-resistant plastic
  - Mounts required; sold separately
- Red | 2879193 | **\$48<sup>99</sup>**  
 Black | 2879192 | **\$48<sup>99</sup>** ★ TOP SELLER  
 White | 2879194 | **\$48<sup>99</sup>**  
 ONLY COMPATIBLE WITH LOW WINDSHIELDS



### REQUIRES A MOUNT



#### HANDGUARD MOUNTS

- Strong mounts ensure proper handguard installation
- Easy install: Mounts directly onto handlebar

2880939 | **\$76<sup>99</sup>**  
 ALL STRAIGHT BAR APPLICATIONS, EXCLUDES ALL 550 INDY® AND VOYAGEUR® MODELS

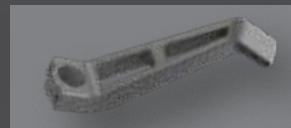

#### RMK® HANDGUARD MOUNTS

- Strong mounts ensure proper handguard installation
- Installs securely on any ProTaper® handlebar

2881241-458 | **\$94<sup>99</sup>**  
 ALL PROTAPER® BARS. FOR FITMENT OF MY10-15 PROTAPER® BARS PROTAPER® FOAM WILL NEED TO BE NARROWED OR REMOVED

# MIRRORS



★ TOP SELLER

## MIRRORS

- Wide-angle view; non-fogging glass
- Folding design for use with cover
- Includes mounting hardware

Pair | 2880292 | **\$124<sup>99</sup>**  
 ALL AXYS®



## HANDLEBAR MIRRORS

- Can be used with stock handlebar pad

Pair | 2876297 | **\$103<sup>99</sup>**  
 ALL PRO-RIDE®



## HOOD MOUNT MIRRORS

- Wide-angle view; non-fogging glass
- Folding design for use with cover
- Includes mounting hardware

Pair | 2877803 | **\$103<sup>99</sup>**  
 ALL PRO-RIDE®

# ELECTRONICS

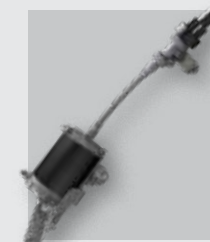

## KEY-OPERATED ELECTRIC START KIT

- The ultimate convenience feature you can add to your sled
- Easier to use and more consistent than pull starts
- Ideal for extreme cold conditions
- Battery required and not included

2881243  
 ALL AXYS® PRO-RMK®, SKS 155, AXYS® RMK® ASSAULT®  
 2880396  
 ALL AXYS®, RUSH®, SWITCHBACK®, AXYS® RMK® 144 600, AXYS® 146 SKS, & AXYS® INDY®

2883849  
 ALL 850 ENGINES  
 2879330  
 ALL PRO-RIDE® INCLUDES 600 INDY®, 600 VOYAGEUR®  
 2879833  
 VOYAGEUR® 550, INDY® 550

**\$829<sup>99</sup>**



## BATTERY (REQUIRED FOR ELECTRIC START KITS)

Sealed, Non-Spill | 4013045 | **\$167<sup>99</sup>**  
 ALL AXYS®, PRO-RIDE®



★ TOP SELLER

## TETHER SWITCH

- Shuts off vehicle if you're separated from it
- Easy to install
- Mounts directly on pod, connects to prewired harness

2874379 | **\$54<sup>99</sup>**  
 ALL 550, 600, 800 ENGINES, ALL AXYS®, ALL PRO-RIDE®

2883823 | **\$54<sup>99</sup>**  
 ALL 850 ENGINES

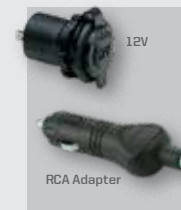

## 12 VOLT / RCA PLUGS

- 12V accessory plugs into 12-volt outlet, great for GPS or phone, dash mount
- RCA adapter allows you to plug in a heated face shield
- RCA power plug includes all hardware required to add an RCA outlet

12V ★ TOP SELLER | 2878475 | **\$76<sup>99</sup>**

RCA Adapter | 2883824 | **\$34<sup>99</sup>**  
 ALL 850 ENGINES

RCA Adapter | 2878227 | **\$29<sup>99</sup>**  
 ALL 550, 600, 800 ENGINES, ALL VEHICLES WITH 12V OUTLET (2878475) INSTALLED

RCA Power Plug (NOT SHOWN) ★ TOP SELLER  
 2878780 | **\$34<sup>99</sup>**  
 ALL AXYS® 600/800 ENGINES, ALL PRO-RIDE®, ALL IQ®

# GAUNTLETS



## DRIVER GAUNTLETS NEW

2883716 | **\$169<sup>99</sup>**  
 FITS ALL STRAIGHTBAR APPLICATIONS



## PASSENGER GAUNTLETS NEW

2883573 | **\$155<sup>99</sup>**  
 FITS VERSA TOURING PASSENGER SEAT AND FT2 PASSENGER SEAT - FOUND ON PG 66.



## UNIVERSAL FORMED HANDLEBAR GAUNTLETS

- Durable exterior with removable insert
  - Gauntlet slides over handgrip; Velcro® strap
- 2879796 | **\$94<sup>99</sup>**  
 FITS ALL HANDLEBARS

# COVERS



Only Polaris® offers a tailored solution for your sled with unmatched reliability and performance

## PREMIUM POLYESTER

- Polyester construction provides extremely durable protection from the elements, especially while trailering
- Fits full range of windshield heights
- Includes integrated straps and hardware
- Coated to repel water and resist UV degradation
- Tested over thousands of miles by Polaris®
- Redesigned stitching for more durability

PRO-RIDE AXYS

PRO-RMK® / SKS	%	2881042	\$284 <sup>99</sup>
RMK® ASSAULT®	%	2881042	\$284 <sup>99</sup>
RUSH®	%	2880431	\$279 <sup>99</sup>
SWITCHBACK®	%	2880431	\$279 <sup>99</sup>
SWITCHBACK® ADVENTURE®	%	2880431	\$279 <sup>99</sup>
RUSH®	Full	2882223	\$309 <sup>99</sup>
SWITCHBACK®	Full	2882224	\$309 <sup>99</sup>
SWITCHBACK® WITH RACK / ADVENTURE®	Full	2882225	\$319 <sup>99</sup>
SWITCHBACK® 144	Full	2882133	\$319 <sup>99</sup>
PRO-RMK® 155 / SKS 146/155	Full	2882133	\$319 <sup>99</sup>
RMK® ASSAULT® 163/174	Full	2882134	\$319 <sup>99</sup>

## CANVAS

- 10 oz. canvas construction provides durable protection from the elements
- Fits full range of windshield heights
- Coated to repel water and resist UV degradation
- Form-fitting elastic cinch design
- Tested over thousands of miles by Polaris®
- Redesigned stitching for more durability

PRO-RIDE AXYS

RUSH® / SWITCHBACK® WITH SPORT RACK	Full	2882136	\$284 <sup>99</sup>
RUSH®	Full	2882135	\$284 <sup>99</sup>
SWITCHBACK®	Full	2882137	\$294 <sup>99</sup>
SWITCHBACK ADVENTURE® WITH RACK	Full	2882138	\$294 <sup>99</sup>
SWITCHBACK® 144 <b>★ TOP SELLER</b>	Full	2881969	\$294 <sup>99</sup>
PRO-RMK® 155 / SKS 146/155	Full	2881969	\$294 <sup>99</sup>
RMK® 163/174	Full	2881980	\$294 <sup>99</sup>
INDY® 121 / INDY EVO®	Full	2878725	\$284 <sup>99</sup>
550 INDY® 144	Full	2879845	\$294 <sup>99</sup>
INDY® VOYAGEUR® 144	Full	2879845	\$294 <sup>99</sup>
550 INDY® ADVENTURE 144 - 155	Full	2879844	\$304 <sup>99</sup>
INDY® LXT	Full	2880515	\$304 <sup>99</sup>
INDY® VOYAGEUR® 144/155 WITH 2-UP SEAT	Full	2880515	\$304 <sup>99</sup>
INDY® VOYAGEUR® 155	Full	2880516	\$304 <sup>99</sup>



## UNDERCOVER

- Made to go under Polaris® snow covers to provide an additional level of protection
- Soft fabric helps to minimize cosmetic damage caused by chafing
- Easy to install and remove
- Works well as a dust cover when machine is stored inside
- The undercover is separate from the cover, which allows it to be kept clean by machine washing. We recommend using a washing machine bag to contain the elastic and hooks
- Air dry

2881981 | \$89<sup>99</sup>  
ALL AXYS®



## CONVERTIBLE COVERS

- Expandable zippered areas allow for multiple accessory configurations with a single cover
- Our most rugged snowmobile cover for the most demanding applications
- High-quality canvas fabric and form-fitting design is ideal for towing or storage

2882800 | \$349<sup>99</sup>  
ALL TITAN™

2883568 | \$349<sup>99</sup> **NEW**  
ALL AXYS® 129, 144 & 146



## CALIBER™ RAMP PRO

The industry's most innovative ramp design for snowmobiles, ATVs, UTVs, and golf carts.

- 52" wide and 90" long
- 1,500 pound rating

2883005 | \$519<sup>99</sup>

ULTIMATE TRACTION AND GLIDE



FINGERS



INTEGRATED FEET

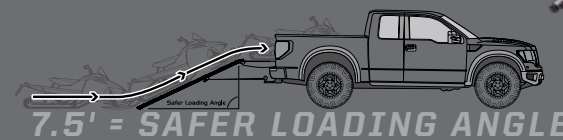

SELF-RETRACTING STRAP INCLUDED



## NEW CALIBER™ SNOW DOLLY

- New 3" big wheel caster design
- Move your sled around the garage with ease

RED | 2883852  
GRAY | 2883853

\$299<sup>99</sup>



## FRONT CLAMP

- Adjustable to fit all snowmobiles
- Rubber silicone pads protect and secure skis
- Integrates to all trailers
- Includes deck hook

2882961 | \$219<sup>99</sup>  
ALL SNOWMOBILES

## REAR CLAMP

- Composite construction with silicone rubber padding
- Tension adjustment knob to fit all snowmobiles
- Secures via rear suspension skid
- 12-inch Supertrac Kit included

2882962 | \$159<sup>99</sup>



SUPERCLAMP DECK HOOKS

2882963 | \$19<sup>99</sup>



SUPERCLAMP TRAC HOOK

2882965 | \$19<sup>99</sup>

SUPERCLAMP TRAC

2882964 | \$38<sup>99</sup>

# SKIS

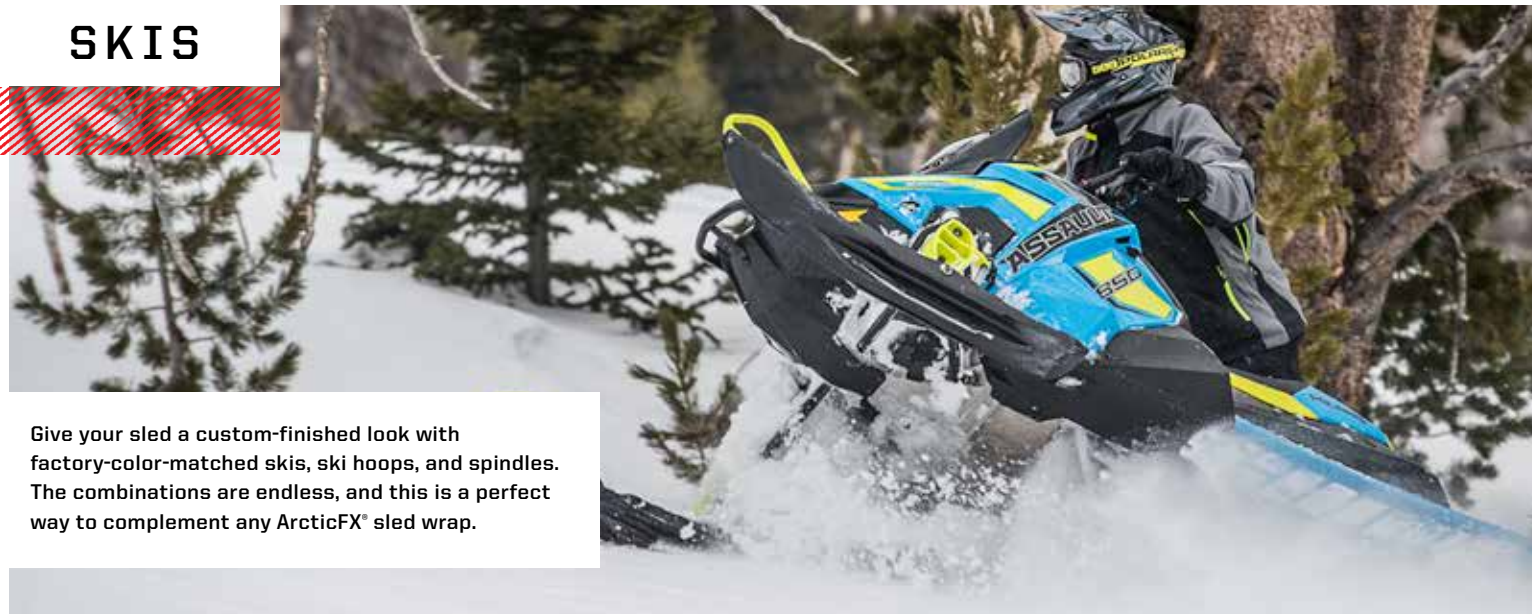

Give your sled a custom-finished look with factory-color-matched skis, ski hoops, and spindles. The combinations are endless, and this is a perfect way to complement any ArcticFX® sled wrap.



## MOUNTAIN

### GRIPPER SKI

AXYS® PRO-RIDE®

- Deep, 1 1/4" keel provides positive steering in deep, loose mountain snow
- Wide, 6 3/4" ski delivers increased flotation
- Top traction surface for boot stepping on ski
- Includes black ski toe and hardware; carbide skags required (sold separately; see chart)
- Sold individually

Black	2877679-070
Red	2877679-293
White	2877679-570
ALL AXYS®, ALL PRO-RIDE®	<b>\$189<sup>99</sup></b>

## UTILITY

### PRO-FLOAT SKI

AXYS® PRO-RIDE®

- Adapted, 9.5" wide PRO-Steer ski design provides 45% more flotation for off-trail deep snow performance
- Includes black ski toe
- Sold individually

Black	2880482
ALL AXYS®, ALL PRO-RIDE®	<b>\$194<sup>99</sup></b>

## TRAIL

### PRO-STEER SKI

AXYS® PRO-RIDE®

- Engineered keel design and shortened skag perfect for the trail
- Supportive ribs for torsional stiffness
- No-slip traction atop ski
- Alternate ski stop may be required
- Includes black ski toe and hardware
- Sold individually

Black	2879152-070
White	2879152-133
Red	2879152-293
ALL AXYS®, ALL PRO-RIDE®	<b>\$189<sup>99</sup></b>



### POLARIS® SKI HOOPS

- Adds custom style
- Reliable high-test tie down; secure sleds quickly and confidently

Black	2876062-070	<b>\$55<sup>99</sup></b>
White	2876062-133	<b>\$60<sup>19</sup></b>
Red	2876062-293	<b>\$60<sup>19</sup></b>
Lime Squeeze	2876062-630	<b>\$59<sup>99</sup></b>
Orange	2876062-647	<b>\$69<sup>99</sup></b>
Blue	2876062-689	<b>\$69<sup>99</sup></b>



COLORED FINISH RESISTS CHIPPING AND WEAR

### SPINDLES

- Strong, lightweight aluminum construction with same tolerances as stock spindles
- Colored finish resists chipping and wear
- Exact replacement for stock RMK® spindles
- Color-matched spindles add a custom look to snowmobile

Red	2881409-293	2881437-293
Black	2881409-458	2881437-458
Lime Squeeze	2881409-630	2881437-630
Orange	2881409-647	2881437-647
Blue	2881409-689	2881437-689

MY15-19 RUSH® & SWITCHBACK®, MY17-19 SWITCHBACK® ASSAULT®, ALL AXYS® RUSH®, SWITCHBACK®, INDY 129, & TITAN™, SKS 155 '19, SKS 146 '19, RMK® ASSAULT® '19, MY16-18 PRO-RMK® & SKS **\$299<sup>99</sup>**

# OPTIMIZING TRACTION AND CONTROL

	SKIS	CARBIDES	TRACK/STUDS
<b>MOUNTAIN</b>	Add Gripper Skis for a deeper keel, greater flotation, and positive steering in deep, loose snow.	For added trail capability, use 4" carbides.	Run a deeper lug and more aggressive track pattern to accommodate softer, deeper snow.
<b>CROSSOVER</b>	Choose PRO-Steer Skis if you prefer more trail riding or Gripper Skis if you use trails to get to your next jump-off point.	For improved cornering without compromising deep-snow performance, use 6" carbides.	Choose a track with a lug depth between 1.35" and 1.75". If you ride off-trail more, choose the lug depth that works for the depth of snow.
<b>TRAIL</b>	For true trail performance, add the Polaris Engineered™ PRO-Steer Ski—specially designed with a low-profile keel.	Dual-runner carbides like the Dooly or Slim Jim reduce darting while increasing corner performance and stability in and out of the apex.	Choose a track based on your sled's rail length and add the number of studs based on your sled model and whether you're a trail, performance, or intermediate rider.

## CARBIDE WEAR STRIPS

Carbides need to be replaced periodically due to normal wear and use. Rocks, cement, pavement, and road crossings all contribute to carbide wear.

## CHOOSE YOUR LENGTH

### 3" - 4" CARBIDE



- Perfect for sleds with a 121" track with 96 studs or less or sleds with 1" lugs taking corners at moderate speeds.

### 6" CARBIDE

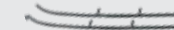

- Ideal for sleds in the 136" track range with up to 1 1/4" lugs or shorter track sleds with more than 96 studs.

### 8" CARBIDE

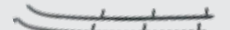

- Best for ultimate performance sleds with a 144" track or longer with paddles and/or the maximum amount of studs.

SKI TYPE	NOTE	STYLE	3" CARBIDE	4" CARBIDE	6" CARBIDE	8" CARBIDE
PRO-Steer Ski	Sold Individually	60"	-	2879025	2879026	2879027
Gripper Ski	Sold Individually	60"	2875723	-	2877880	2877881
RUSH® Ski	Sold Individually	60"	-	2878524	2875613	2875614
Sidehiller Ski	Pair	60"	-	2874334	2875146	-
Polaris® Race Ski	Pair	60"	-	2875142	2875143	-
Youth 120	Pair	60"	2870997	-	-	-

\*Accu-trak Dual Runners fit Saddleless Ski only and are sold as single wear bars



### BITEHARDER® CARBIDE SHARPENER

- Designed to be used with portable drill for sharpening anywhere
- Carbide wear bar sharpening tool for use on the trail or in the shop
- Quickly and easily puts a fresh edge on wear bars for improved handling
- Delivers more precise and accurate handling, especially in the corners
- Features long-lasting V-shaped, diamond-coated sharpening stone
- Long-lasting diamond media can sharpen up to 40 wear bars

2882952 | **\$90<sup>99</sup>**

# SHOCKS

TRAIL



## WALKER EVANS® TRAIL PERFORMANCE SHOCKS

- External hi/lo ProDial compression damping adjustment
- Piggyback reservoir provides increased oil and nitrogen volumes for fade-free performance
- Velocity- and position-sensitive needle damping
- Ultra-progressive MCU bump stop
- 100% designed, engineered, and manufactured in the U.S.A.
- Fully rebuildable and revalveable

**IFS (EACH)\***  
2881946 | **\$499<sup>99</sup>**  
SWITCHBACK® ADVENTURE® '19, MY15-19 AXYS® RUSH® & SWITCHBACK® 137, MY17-18 AXYS® SWITCHBACK® ASSAULT®, SWITCHBACK® SP, INDY® XC '19, INDY® SP '19

**FRONT TRACK\***  
2881947 | **\$499<sup>99</sup>**  
SWITCHBACK® ADVENTURE® '19, MY15-19 AXYS® RUSH® & SWITCHBACK® 137, MY17-18 AXYS® SWITCHBACK® ASSAULT®, SWITCHBACK® SP, 600 VOYAGEUR® 144, 600 RMK® 144, INDY® XC '19, INDY® SP '19

**REAR TRACK\***  
2881948 | **\$499<sup>99</sup>**  
SWITCHBACK® ADVENTURE® '19, MY15-19 AXYS® RUSH® & SWITCHBACK® 137, SWITCHBACK® '19, INDY® XC '19, INDY® SP '19

CROSSOVER



## FOX® SWITCHBACK® SHOCKS

- Quick Switch 3 compression dial makes for quick adjustments for changing conditions
- Coil over air shock design
- 6061 aluminum body with anodized finish

**IFS (EACH)\***  
2881411 | **\$779<sup>99</sup>**  
MY15-18 AXYS® RUSH® & SWITCHBACK® 137, MY17-19 AXYS® SWITCHBACK® ASSAULT®, SWITCHBACK® SP

**FRONT & REAR TRACK SHOCK SET\*\***  
2881412 | **\$1,289<sup>99</sup>**  
MY15-18 AXYS® RUSH® AND SWITCHBACK® 137

MOUNTAIN

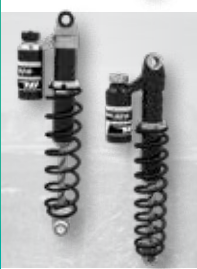

## WALKER EVANS® CROSSOVER SHOCK

- Velocity- and position-sensitive needle damping
- 16-way compression adjuster to fine-tune ride through changing conditions
- Piggyback reservoir provides increased oil and nitrogen volumes for fade-free performance
- Progressive MCU bump stop

**IFS (EACH)\*\*\***  
2881970 | **\$449<sup>99</sup>**  
MY15-19 AXYS® RUSH® AND SWITCHBACK® 137, MY17-19 SWITCHBACK® ASSAULT®, AND SWITCHBACK® SP

**FRONT TRACK\*\*\***  
2881971 | **\$449<sup>99</sup>**  
MY15-19 AXYS® RUSH® AND SWITCHBACK® 137, MY17-19 SWITCHBACK® ASSAULT®, SWITCHBACK® SP, 600 VOYAGEUR® 144, 600 RMK® 144

**REAR TRACK\*\*\*\***  
2881972 | **\$449<sup>99</sup>**  
MY17-19 SWITCHBACK® ASSAULT®, SWITCHBACK® SP, 600 VOYAGEUR® 144, 600 RMK® 144

## WALKER EVANS® AXYS® DEEP SNOW PREMIUM SHOCK

- 16-way compression adjuster to fine-tune ride through changing conditions
- Lightweight 6061 T6 extruded aluminum alloy design
- Piggyback reservoir provides increased oil and nitrogen volumes for fade-free performance

- Front track shock features an internal floating piston monotube for consistent, fade-free performance
- 100% designed, engineered, and manufactured in the U.S.A.
- Fully rebuildable and revalveable

**IFS (NEED TWO)**  
2881058 | **\$499<sup>99</sup>**  
INCLUDES MOUNTING HARDWARE, DOES NOT INCLUDE COIL OVER SPRING  
AXYS® PRO-RMK®, SKS 155 '19, SKS 146 '19, RMK® ASSAULT® '19, PRO-RMK® '19

**REAR TRACK**  
2881059 | **\$499<sup>99</sup>**  
INCLUDES MOUNTING HARDWARE AND COIL OVER SPRING  
AXYS® PRO-RMK® SKS 155 '19, SKS 146 '19, RMK® ASSAULT® '19, PRO-RMK® '19



## RMK® SLS SUSPENSION SPRINGS

- Lighter than titanium
- 3 lb. weight reduction over stock springs
- Increased performance over stock springs

**FRONT IFS SHOCK SPRINGS**  
2883682-458 | **\$389<sup>99</sup>**  
ALL PRO-RMK® '16-'19, MY16-19 SKS 155

**TRACK SHOCK SPRINGS**  
2883715-458 | **\$389<sup>99</sup>**  
ALL PRO-RMK® '16-'19, SKS 155 '16-'19



## INDY® EVOLUTION KIT

- Comes with everything you need to evolve your INDY EVO™ as the rider's skill increases
- Includes tie rods, control arms, spindles, shocks, and more!

2883939 | **\$1,934<sup>99</sup>**  
INDY EVO™

# STUDS

RIP WITH AN **IRON GRIP**: Track studs allow you to dominate terrain as far and as fast as you can see. The right stud improves acceleration, braking, steering, and control, especially on hard-packed snow and ice. The more aggressive your riding style, the more traction your sled needs to perform at its best.

### CHOOSING THE RIGHT STUD

1. Determine your riding style and terrain.
2. Find sled model info and number of studs required.
3. Determine length of turning carbides to balance traction and steering.
4. Make sure the studs won't interfere with your tunnel or cooling system.

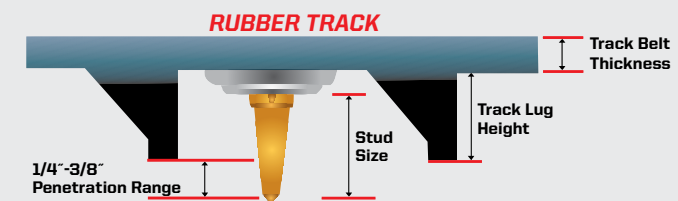

## STUDS AND WEAR STRIP FIT CHART

MODEL	TRACK	TRACK LENGTH	LUG HEIGHT	STUD SIZE	WEAR STRIP KIT	STUD QUANTITY		
						TRAIL	INTERMEDIATE	PERFORMANCE
550 INDY® LXT 144	5414190	15" X 144"	1"	1.075	2879831	108	144	162
550 INDY® LXT 144 INT	5414013	15" X 144"	1.352"	1.325/1.450	2879831	144	152	171
550 INDY® Adventure®	5414013	15" X 144"	1.352"	1.325/1.450	2879831	144	152	171
550 INDY® 121	5412281	15" X 136"	0.91"	1.075	2879830	108	144	162
550 INDY® 144	5414013	15" X 144"	1.352"	1.325/1.450	2879831	144	152	171
550 INDY® Voyageur® 155	5414902	15" X 155"	1.6"	Not recommended	2879831	144	152	171
600/800 INDY®	5412281	15" X 121"	0.91"	1.075	2879212	96	144	162
600/800 INDY® SP	5413198	15" X 121"	1"	1.075	2879212	96	144	162
600/800 RUSH®	5413198	15" X 121"	1"	1.075	Standard	96	144	162
600 RUSH® PRO-RIDE®	2875512	15" X 121"	1.25"	1.325	Standard	96	144	162
600 SWITCHBACK®	2875639	15" X 136"	1.25"	1.325	Standard	108	144	162
800 RUSH®	5413198	15" X 121"	1"	1.075	Standard	96	144	162
800 RUSH® PRO-RIDE®	2875512	15" X 121"	1.25"	1.325	Standard	96	144	162
800 RUSH® PRO-RIDE® LE	2877377	15" X 121"	1.352"	1.325/1.450	Standard	96	144	162
800 SWITCHBACK®	2875639	15" X 136"	1.25"	1.325	Standard	108	144	162
800 SWITCHBACK® PRO-RIDE®	2877678	15" X 136"	1.352"	1.325/1.450	Standard	108	144	162
MY17-19 AXYS® 144"	5414013	15" X 144"	1.352"	1.325/1.450	2881605	144	152	171
600/800 RUSH®	5414653	15" X 120"	1.25"	1.325	Standard	108	144	162
600/800 RUSH®	5414894	15" X 120"	1.75"	Not recommended	Standard	-	-	-
600/800 RUSH®	2877748	15" X 120"	1.352"	1.325	Standard	-	-	-
600/800 SWITCHBACK®	5414654	15" X 137"	1.25"	1.325	Standard	108	144	162
600/800 SWITCHBACK®	5414895	15" X 137"	1.75"	Not recommended	Standard	-	-	-
600/800 SWITCHBACK®	5413661	15" X 137"	1.352"	1.325	Standard	108	144	162

## 96 PACK STUDS

TRACTION MASTER® 5/16 | 96 PACK 1.325" | 2873139 | **\$259<sup>99</sup>**

SIGNATURE SERIES 5/16 | 96 PACK 1.075" | 2875155 | **\$179<sup>99</sup>**

SIGNATURE SERIES 5/16 | 96 PACK 1.325" | 2875149 | **\$179<sup>99</sup>**

SIGNATURE SERIES 5/16 | 96 PACK 1.45" | 2879161 | **\$179<sup>99</sup>**

## 144 PACK STUDS

Signature Series 5/16 | 144 Pack 1.45" | 2879162 | **\$344<sup>99</sup>**

## WEAR STRIP KITS

- Protects tunnel when installing studs
- Made of ultra-durable UHMW material

MY11-15 550 LXT  
2877687 | **\$144<sup>99</sup>**

MY13-15 600/800 INDY®  
2879212 | **\$135<sup>99</sup>**

MY11-16 SWITCHBACK® ASSAULT®  
2878161 | **\$199<sup>99</sup>**

550 INDY® 144, VOYAGEUR®  
2879831 | **\$144<sup>99</sup>**

550 INDY® 121  
2879830 | **\$135<sup>99</sup>**

MY17-19 SWITCHBACK® ASSAULT®  
2881605 | **\$209<sup>99</sup>**

K-WEAR STRIP 155 TITAN®  
2882880 | **\$219<sup>99</sup>**

INDY® XC 129  
2883572 | **\$169<sup>99</sup>**

## ALUMINUM BACKER PLATES

ROUND | 24 PACK | 5/16  
2874324 | **\$23<sup>99</sup>**

ROUND | 96 PACK | 5/16  
2874325 | **\$69<sup>99</sup>**

ROUND | 1,000 PACK | 5/16  
2874329 | **\$714<sup>99</sup>**

SQUARE | 96 PACK | 5/16  
2873153 | **\$89<sup>99</sup>**



## TRAIL BOGIE WHEELS

Solid Bogie Wheel-External Rail  
2881955 | **\$124<sup>99</sup>**

INCLUDES 4. MY15-18 AXYS® RUSH® AND SWITCHBACK®, MY17-18 ASSAULT® 144, MY17-18 SWITCHBACK® SP 144, MY17-18 600 VOYAGEUR®

Solid Bogie Wheel-Internal Rail  
2881956 | **\$59<sup>99</sup>**

INCLUDES 2. MY15-18 AXYS® RUSH® AND SWITCHBACK®, MY17-18 ASSAULT® 144, MY17-18 SWITCHBACK® SP 144, MY17-18 600 VOYAGEUR®

XCR® Rear Axle Wheel Kit  
2881954 | **\$124<sup>99</sup>**

4 WHEELS & SPACER INCLUDED. MY15-18 AXYS® RUSH® AND SWITCHBACK®

144/146 HD Rear Skid Upgrade Kit  
2882916 | **\$194<sup>99</sup>**

KIT INCLUDES 4 AXLE WHEELS AND RAIL STIFFENERS

Low Snow Kit  
2882802 | **\$129<sup>99</sup>**  
POLARIS® TITAN™



## ICE SCRATCHERS

- Direct ice chips into skid to lube and cool hi-fax
- Permits wheel removal on SKS 155, saving 4 lbs.

2882028 | **\$94<sup>99</sup>**

AXYS® PRO-RMK®, ASSAULT® RMK®, SKS 155, COMES STANDARD ON AXYS® PRO-RMK®, ASSAULT® RMK®

2876256 | **\$94<sup>99</sup>**

PRO-RIDE® RMK®, RMK® ASSAULT®



## RMK® BOGIE WHEEL KIT

- Wheels install on stock skid
- Reduces hi-fax wear on hard pack snow and ice
- Sold in pairs
- A total of 3 pairs can be installed onto a stock skid

2882048 | **\$68<sup>99</sup>**

AXYS® PRO-RMK® 174, AXYS® PRO-RMK®, ASSAULT® RMK®, SKS, COMES STANDARD ON SKS 155

2878251 | **\$55<sup>99</sup>**

PRO-RIDE®



## XCR TORSION BAR KIT

- Reduces body roll when cornering

2881950 | **\$169<sup>99</sup>**

MY15-18 AXYS® RUSH® AND SWITCHBACK®

# TRACKS



## FEEL THE DIFFERENCE

A snowmobile's track is a major component to performance. We build tracks for specific needs—whether you climb the highest peaks, carve the tightest trails, or race against the toughest competition. From improved acceleration, to better handling, to increased traction in deep snow, dial in your ride.

## TRAIL

### COBRA

ON TRAIL OFF TRAIL

- Cupped lugs for superior acceleration and braking in loose, soft snow conditions
- Flexible lug design for superior off-trail performance

LENGTH	PITCH	LUG HEIGHT		
120"	2.86"	1.352"	2839284	<b>\$844</b> <sup>99</sup>
121"	2.52"	1.352"	2839052	<b>\$831</b> <sup>99</sup>
129"	2.86"	1.352"	2839235	<b>\$896</b> <sup>99</sup>
136"	2.52"	1.352"	2839061	<b>\$909</b> <sup>99</sup>
137"	2.86"	1.352"	2839093	<b>\$1,008</b> <sup>99</sup>
137"	2.86"	1.352"	2839307	<b>\$948</b> <sup>99</sup>
137"	2.86"	1.352"	5413661	<b>\$756</b> <sup>99</sup>
144"	2.52"	1.352"	2839107	<b>\$1,013</b> <sup>99</sup>
144"	2.86"	1.352"	5414013	<b>\$1,013</b> <sup>99</sup>
144"	2.86"	1.6"	5416162	<b>\$1,103</b> <sup>99</sup>
155"	2.86"	1.5"	5415826	<b>\$1,143</b> <sup>95</sup>
155"	2.86"	1.8"	5416020	<b>\$1,180</b> <sup>79</sup>

## MOUNTAIN

### SERIES 7

ON TRAIL OFF TRAIL

- Polaris® exclusive
- Ideal track to provide lift in the deepest, softest snow conditions
- Features a new lightweight single-ply design optimized for weight and powder snow performance

LENGTH	PITCH	LUG HEIGHT		
155"	3"	3"	5415393	<b>\$1,734</b> <sup>95</sup>
163"	3"	3"	5415394	<b>\$1,795</b> <sup>79</sup>
174"	3"	3"	5415786	<b>\$2,066</b> <sup>99</sup>

### SERIES 6

ON TRAIL OFF TRAIL

- Outstanding traction and control in deep snow
- Lugs provide tremendous flotation and great performance
- 2.6" lugs provide outstanding traction in all deep snow conditions
- Design provides outstanding flotation and control

LENGTH	PITCH	LUG HEIGHT		
155"	2.86"	2.6"	5415391	<b>\$1,475</b> <sup>99</sup>
163"	2.86"	2.6"	5415392	<b>\$1,598</b> <sup>99</sup>

### SERIES 5.1

ON TRAIL OFF TRAIL

- Industry-leading deep powder track; for 8T drive sprockets, 2.86" pitch
- Optimized lug pattern producing 19% more forward lug contact compared to our Series 5.0 track
- Soft and flexible tips for superior performance in deep snow

LENGTH	PITCH	LUG HEIGHT		
155"	2.86"	2.4"	5413622	<b>\$1,131</b> <sup>99</sup>
163"	2.86"	2.4"	5413621	<b>\$1,303</b> <sup>79</sup>

### PEAK 2.25

ON TRAIL OFF TRAIL

- Angular lugs bite and funnel snow under the snowmobile for outstanding flotation
- Features soft lugs for powder snow and hard lugs for heavy/wet snow
- Outer lug bars deliver better lateral control for improved handling

LENGTH	PITCH	LUG HEIGHT		
155"	2.86"	2.25"	5415002	<b>\$1,131</b> <sup>99</sup>

### SERIES 5.2

ON TRAIL OFF TRAIL

- Modeled after the modified Series 5.1 track used by Polaris® hillclimb racers
- Provides great traction both on and off trail
- Maintains excellent durability
- Optimized lug pattern for more forward lug contact

LENGTH	PITCH	LUG HEIGHT		
146"	2.86"	2.25"	5416498	<b>\$1,131</b> <sup>99</sup>

### SERIES 4

ON TRAIL OFF TRAIL

- The standard in 2" deep snow tracks; for 9T drive sprockets, 2.52" pitch
- Equal parts versatility and durability
- Stiff lug base for long wear and hard-pack performance
- Soft and flexible tips for superior performance in deep snow

LENGTH	PITCH	LUG HEIGHT		
144"	2.52"	2"	5413073	<b>\$959</b> <sup>99</sup>
144"	2.52"	2"	5415692	<b>\$983</b> <sup>99</sup>

### SHOCKWAVE

ON TRAIL OFF TRAIL

- Designed for hard-working, utility applications
- Able to handle heavy workloads in deep-snow, off-trail environments
- Tackles on-trail, hardpacked applications, too
- 1" lug height with 2.52" pitch

LENGTH	PITCH	LUG HEIGHT		
156"	2.52"	1"	5414453	<b>\$1,853</b> <sup>99</sup>

## COMPETITION TRACK

ON TRAIL OFF TRAIL

- Customized for snocross competition
- Developed for, and tested by, top Polaris® racers

LENGTH	PITCH	LUG HEIGHT		
121"	2.52"	1.81"	5413352	<b>\$806</b> <sup>99</sup>
146"	2.86"	2.125"	5413490	<b>\$1,361</b> <sup>75</sup>
155"	2.86"	2.1"	2877304	<b>\$1,242</b> <sup>95</sup>

## YOUTH 120

ON TRAIL OFF TRAIL

- Replacement track for the Polaris® 120 INDI®

LENGTH	PITCH	LUG HEIGHT		
68"	2.55"	.71"	5411751	<b>\$356</b> <sup>75</sup>

## CROSSOVER

### BACKCOUNTRY

ON TRAIL OFF TRAIL

- Arched lug design with staggered, snocross-inspired pattern for excellent soft-snow traction

LENGTH	PITCH	LUG HEIGHT		
120"	2.52"	1.75"	5414894	<b>\$909</b> <sup>99</sup>
121"	2.52"	1.75"	2839140	<b>\$909</b> <sup>99</sup>
121"	2.52"	1.75"	5415097	<b>\$909</b> <sup>99</sup>
136"	2.52"	1.75"	2839142	<b>\$1,000</b> <sup>99</sup>
136"	2.52"	1.75"	5414378	<b>\$1,000</b> <sup>99</sup>
137"	2.86"	1.75"	5414895	<b>\$1,013</b> <sup>99</sup>
144"	2.52"	1.75"	2839143	<b>\$1,117</b> <sup>99</sup>
144"	2.52"	1.75"	5415096	<b>\$1,117</b> <sup>99</sup>

### BACKCOUNTRY X

ON TRAIL OFF TRAIL

- Arched lug design with staggered, snocross-inspired pattern for excellent soft-snow traction
- All 2.86" drive pitch models feature tapered lugs on outside edges for improved durability
- 3" drive pitch also available

LENGTH	PITCH	LUG HEIGHT		
120"	2.86"	1.75"	2839287	<b>\$909</b> <sup>99</sup>
137"	2.52"	1.75"	2839289	<b>\$1,013</b> <sup>99</sup>

### BACKCOUNTRY X2

ON TRAIL OFF TRAIL

- Arched lug design with staggered, snocross-inspired pattern for excellent soft-snow traction
- Rigid lug support columns and optimized rubber compound to deliver great on/off-trail performance
- 2.86" drive pitch

LENGTH	PITCH	LUG HEIGHT		
120"	2.86"	2.86"	2839256	<b>\$1,000</b> <sup>99</sup>
129"	2.86"	2.86"	2839257	<b>\$1,065</b> <sup>99</sup>
137"	2.86"	2.86"	2839258	<b>\$1,104</b> <sup>99</sup>

### COBRA 1.6

ON TRAIL OFF TRAIL

- Cupped lugs for superior acceleration and braking in loose, soft snow conditions
- Flexible lug design for superior off-trail performance
- Select lugs are more rigid for traction on hard-packed snow

LENGTH	PITCH	LUG HEIGHT		
120"	2.86"	1.6"	2839291	<b>\$961</b> <sup>99</sup>
120"	2.86"	1.6"	5414902	<b>\$1,059</b> <sup>95</sup>
129"	2.86"	1.6"	2839292	<b>\$1,026</b> <sup>99</sup>
137"	2.86"	1.6"	2839264	<b>\$1,039</b> <sup>99</sup>
155"	2.86"	1.6"	5414902	<b>\$1,059</b> <sup>95</sup>
155"	2.86"	1.6"	2839283	<b>\$1,091</b> <sup>99</sup>

### ICE COBRA 1.6

ON TRAIL OFF TRAIL

- Cupped lugs for superior acceleration and braking in loose, soft snow conditions
- Flexible lug design for superior off-trail performance
- Factory pre-studded with 1.6" lugs for excellent all-round performance, especially on ungroomed trails

LENGTH	PITCH	LUG HEIGHT		
120"	2.86"	1.6"	2839244	<b>\$1,013</b> <sup>99</sup>
137"	2.86"	1.6"	2839246	<b>\$1,117</b> <sup>99</sup>
155"	2.86"	1.6"	2839273	<b>\$1,156</b> <sup>99</sup>

### CHALLENGER

ON TRAIL OFF TRAIL

LENGTH	PITCH	LUG HEIGHT		
121"	2.52"	2"	2839798	<b>\$922</b> <sup>99</sup>
136"	2.52"	2"	2839797	<b>\$1,013</b> <sup>99</sup>
137"	2.86"	2"	2839186	<b>\$1,143</b> <sup>99</sup>
144"	2.52"	2"	2839875	<b>\$1,156</b> <sup>99</sup>
146"	2.86"	2.5"	2839145	<b>\$1,130</b> <sup>99</sup>
151"	2.52"	2"	2839876	<b>\$1,195</b> <sup>99</sup>
153"	3"	2.5"	2839174	<b>\$1,169</b> <sup>99</sup>
154"	2.86"	2.5"	2839104	<b>\$1,169</b> <sup>99</sup>
156"	3"	3.2"	2839320	<b>\$1,715</b> <sup>99</sup>
162"	3"	3.2"	2839175	<b>\$1,234</b> <sup>99</sup>
162"	3"	2.5"	2839319	<b>\$1,767</b> <sup>99</sup>
163"	2.86"	2.5"	2839105	<b>\$1,221</b> <sup>99</sup>

# FOR THE LIFE OF YOUR RIDE

Maintenance is the key to keeping your Polaris® snowmobile performing at its peak. Items like belts, lubricants, and batteries represent only a few of these critical items engineered specifically by Polaris.

## POLARIS ENGINEERED™ DRIVE BELTS

### TESTED, PERFECTED

We test each belt on the intended vehicle - we don't just try to make an existing belt "just work".

- Amery Kuhl, Polaris® CVT System Engineer

### OUR INVESTMENT

- 20,000 miles of field testing
- Thousands of dyno hours
- 18+ months of development (3,000+ design hours) per belt
- 1200+ vehicle validation hours
- Collaboration with powertrain & clutch engineers

### YOUR ADVANTAGE

- No clutch recalibration
- Less wear & tear due to heat
- Ensure maximum performance of your vehicle
- More time out riding, less time wrenching

**OUR INVESTMENTS ENSURE POLARIS BELTS OUTPERFORM YOUR EXPECTATIONS.**

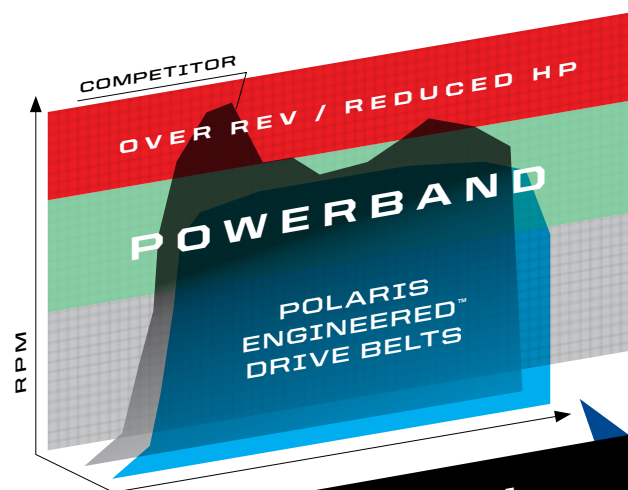

**RUN AT THE OPTIMAL RPM WITH POLARIS ENGINEERED™ DRIVE BELTS**

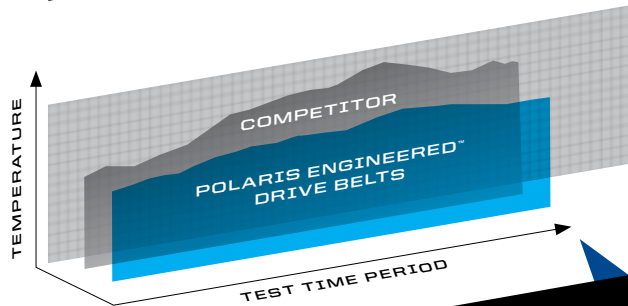

**# 1 REASON BELTS FAIL IS HEAT POLARIS BELTS RUN COOLER THAN THE COMPETITION, EVEN AT HIGH RPMs**

**AFTERMARKET BELTS RUN HOTTER OVERSIZED AFTERMARKET COGS FAIL DUE TO OVER-TRAVEL INTO THE DRIVE CLUTCH CREATING HIGH HEAT**

# MAINTENANCE SCHEDULE

CHECK YOUR OWNER'S MANUAL FOR ADDITIONAL RECOMMENDED SERVICE ITEMS AND VEHICLE-SPECIFIC TIMING

PRE-SEASON	500 MI (800 KM) IN-SEASON	2000 MI (3200 KM) IN-SEASON	END OF SEASON
<b>ENGINE OIL:</b> FILL TO RECOMMENDED LEVEL  <b>GENERAL LUBRICATION:</b> ALL FITTINGS, PIVOTS, CABLES, ETC.  <b>CHECK FOR WEAR:</b> TEST, CLEAN & CHECK FLUID LEVELS SPARK PLUGS, TRACK, SLIDER, DRIVE BELT, & CARBIDES	<b>ENGINE OIL:</b> FILL TO RECOMMENDED LEVEL  <b>DRIVE BELT:</b> INSPECT & ADJUST FOLLOW BREAK-IN PROCEDURE AFTER INSTALLATION  <b>TRANSMISSION FLUID:</b> CHANGE	<b>ENGINE OIL:</b> FILL TO RECOMMENDED LEVEL  <b>CHECK FOR WEAR:</b> TEST, CLEAN & CHECK FLUID LEVELS SPARK PLUGS, TRACK, SLIDER, DRIVE BELT, & CARBIDES  <b>DRIVE BELT:</b> INSPECT & ADJUST REPLACE AS NEEDED	<b>DRIVE BELT:</b> REMOVE CONSULT OWNER'S MANUAL  <b>FUEL:</b> ADD FUEL STABILIZER  <b>TRACK:</b> INSPECT REDUCE TENSION DURING STORAGE  <b>BATTERY:</b> REMOVE

CHECK OUT OUR **PARTS FINDER ON POLARIS.COM** FOR EASY PARTS LOOK-UP, PARTS IDENTIFICATION, VIEWS OF ASSEMBLIES, AND MORE!

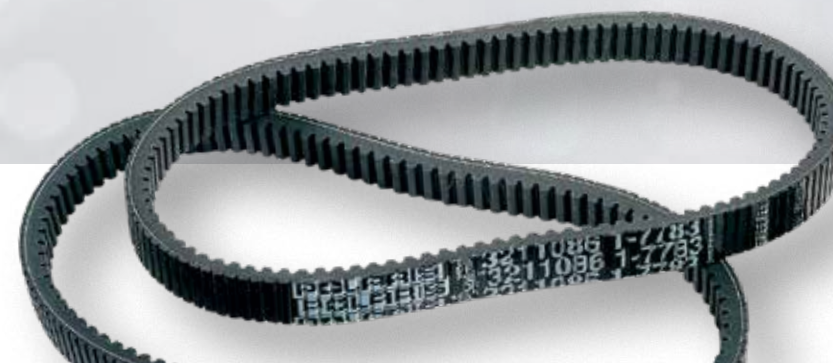

BELT COMPOUND & CONSTRUCTION NOTES	BELT WIDTH*	OUTER CIRCUMFERENCE*	PART NO.	PRICE
<b>AXYS® (RUSH®, SWITCHBACK®, SWITCHBACK® ADVENTURE®, SWITCHBACK® ASSAULT®, VOYAGEUR®, POLARIS® TITAN® &amp; INDY® 129)</b>				
HIGH MODULUS CHLOROPRENE BELT	1.46" (37.10mm)	45.16"	3211215 (850cc)	\$239 <sup>99</sup>
PBO BELT	1.46" (37.10mm)	45.16"	3211177 (800cc)	\$239 <sup>99</sup>
PBO BELT	1.46" (37.10mm)	45.16"	3211165 (600cc)	\$227 <sup>99</sup>
<b>AXYS® (PRO-RMK®, RMK® ASSAULT®, SKS)</b>				
HIGH MODULUS CHLOROPRENE BELT	1.46" (37.10mm)	46.77"	3211216 (850 cc)	\$239 <sup>99</sup>
PBO BELT	1.46" (37.10mm)	46.77"	3211183 (800cc)	\$239 <sup>99</sup>
PBO BELT	1.46" (37.10mm)	46.77"	3211115 (600cc)	\$227 <sup>99</sup>
<b>PRO-RIDE® (RUSH®, SWITCHBACK®, SWITCHBACK® ASSAULT®, INDY®, VOYAGEUR®, PRO-RMK®, RMK®, RMK® ASSAULT®)</b>				
PBO BELT	1.46" (37.10mm)	46.77"	3211115	\$227 <sup>99</sup>
KEVLAR® BELT	1.46" (37.10mm)	46.77"	3211122	\$197 <sup>99</sup>
KEVLAR® BELT	1.32" (33.53mm)	43.23"	3211174 (550cc)	\$179 <sup>99</sup>
STANDARD BELT	1.29" (32.77mm)	42.48"	3211154 (550cc)	\$179 <sup>99</sup>

**FIND THE RIGHT BELT FOR YOUR MACHINE IN OUR ONLINE PARTS CATALOG AT POLARIS.COM**

\*Belt dimensions are given in nominal dimensions. There is a +/- variance for all critical dimensions. Clutch setup must be inspected when a new belt is installed and should be adjusted if necessary. The drive belt is an important component in the CVT system. In order to achieve maximum efficiency from the converter, drive belt deflection (tension), clutch offset, and alignment must be adjusted properly. See your Service Manual for further details on drive belt measurement inspection.

## MAINTENANCE



**BATTERIES**  
4013045



**SPARK PLUGS**  
Engineered for your Polaris® sled  
NGK | 3022082  
Champion | 3070190

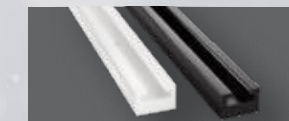

**SLIDERS**  
5521632  
5521633-070  
5521633-309  
5522144-070



## THE BEST OIL ON SNOW

POLARIS ENGINEERED™ OILS & LUBRICANTS are developed, tested, and approved by Polaris® engineering for use in Polaris Snowmobiles. Polaris Engineers rigorously test every fluid before it earns the right to wear the Polaris Engineered Lubricants™ badge. Protect your investment with Polaris Engineered™ Oils & Lubricants.

### VES SYNTHETIC 2-CYCLE OIL

1 Quart 2877882	16-Gallon Drum 2877885
1 Gallon 2877883	55-Gallon Drum 2877886
2.5 Gallon 2877884	330-Gallon Tote 2877892

### VES EXTREME SYNTHETIC 2-CYCLE OIL **NEW**

1 Quart 2883733	55-Gallon Drum 2883735
1 Gallon 2883732	330-Gallon Tote 2883736
16-Gallon Drum 2883734	

### POLARIS® BLUE 2-CYCLE OIL

1 Quart 2882201	16-Gallon Drum 2882203
1 Gallon 2882202	55-Gallon Drum 2882205
2.5 Gallon 2882204	330-Gallon Tote 2882206

### VP RACING FUELS

- Developed with VP Race Fuels and tested by the Polaris® Factory Race Team to meet the demands of high-horsepower stock and modified racing engines
- Legal-stock fuel for most race sanctions; dilute to meet specific octane requirements

110 Octane   5-Gallon Pail 2880305	110 Octane   54-Gallon Drum 2880304
---------------------------------------	--

114+ Octane   5-Gallon Pail 2880307	114+ Octane   54-Gallon Drum 2880306
--	---

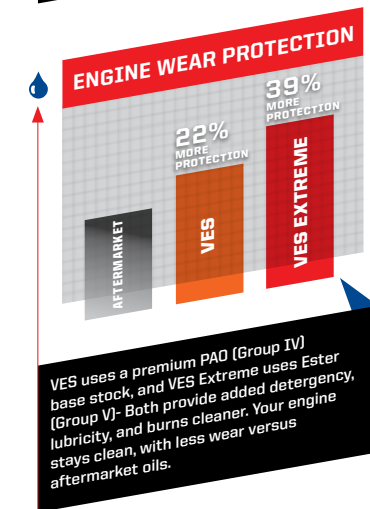
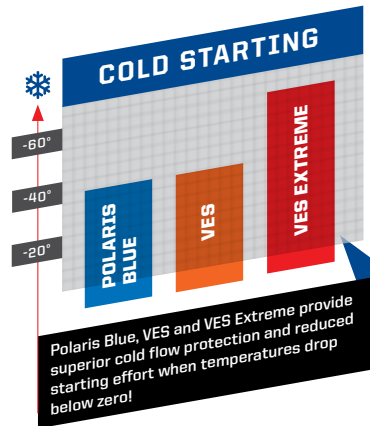

### VES

Clean-burning, low-odor, smokeless oil formulation designed to improve exhaust valve performance. VES offers maximum engine protection.

- Formulated for easy starting in extreme cold
- Improved rust and corrosion inhibitor package
- Full synthetic base oil formulation offers excellent load carrying abilities to reduce engine wear
- Provides enhanced valve cleanliness, low smoke & excellent lubricity

### VES EXTREME **NEW**

VES Extreme is engineered, formulated, and tested to easily handle the increased demands of today's high-performance Polaris® snowmobile engines.

#### WHY VES EXTREME?

- Highest-quality full-synthetic Ester base stocks
- Enhanced detergency for pistons, rings, and exhaust valves
- Cold flow properties proven superior to leading aftermarket oils
- Made to handle high heat, high RPM applications

### POLARIS® BLUE

Specially formulated synthetic blend 2-cycle engine oil provides excellent protection and performance in all 2-cycle injector or pre-mix non-VES applications.

- Provides superior engine protection and performance in all conditions
- Smokeless formulation, synthetic-blend oil
- Formulated for easy starting in extreme cold

# ENGINEERED TO MAXIMIZE THE LIFE OF YOUR RIDE

All Polaris® fluids—from anti-freeze to brake fluid—are developed for your vehicle. Trust the only fluids perfectly engineered for your needs.

### CARBON CLEAN

Polaris® Carbon Clean prevents ethanol corrosion, stabilizes fuel, and cleans carburetor jets and fuel injector nozzles, deposits on piston and rings, intake systems, and combustion chambers. Antioxidants preserve fuel and prevent fuel system gumming.

### SYNTHETIC CHAINCASE LUBE

Unlike typical gear case oils, SCL's unique viscosity range allows instant flow and film protection in extreme cold or high heat environments.

### ANTI-FREEZE

Polaris® Extended Life Anti-Freeze contains organic acid technologies to prevent corrosion on metal components, eliminate scaling, and maximize cooling system performance.

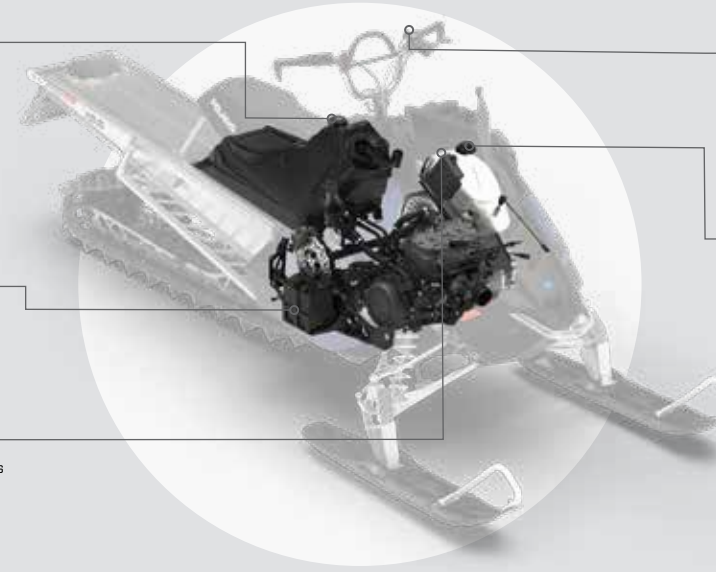

### DOT 4 BRAKE FLUID

Polaris® DOT 4 Brake Fluid is designed for use in Polaris® hydraulic brakes. Superior high-temp characteristics plus anti corrosion additives extend the life of brake system components.

### OIL

Polaris Blue, VES, and VES Extreme 2-cycle oils are tested to perform, and are the only oils developed specifically for your Polaris snowmobile engine. Exclusive anti-wear additives protect engine parts with extra rust and corrosion protection.

### ALL-SEASON GREASE

Polaris All-Season Grease is designed to maintain consistency across a wide range of temperatures. Engineered to protect front and rear suspension components, steering bushings, and driveline bearings.



### EXTENDED LIFE ANTI-FREEZE 50/50 FORMULATION

1 Quart   2880514
1 Gallon   2880513
55-Gallon Drum   2880512

### ALL-SEASON GREASE

3 oz. 4-pack   2871322
14 oz.   2871423

### SYNTHETIC CHAINCASE LUBE

1 Quart   2873105
1 Gallon   2873106
2.5 Gallon   2872952

### SHOCK OIL

Walker Evans® 5wt 1 Quart   2874522
Premium FOX® 1 Quart   2870995
Premium FOX® 2.5 Gallon   2872279

### FOGGING OIL

12 oz.   2870791
------------------

### BRAKE FLUID

12 oz.   2872189
------------------

### CHAIN LUBE

15 oz.   2872348
------------------

### LUBRICANT ACCESSORIES



#### GREASE GUN KIT

FITS 2871322 ALL-SEASON AND 2871515 U-JOINT 3 OZ.  
2871312 | \$44<sup>99</sup>



#### 2D BATTERY-OPERATED SIPHON PUMP

- Liquid transfer pumps 5-6 quarts/min. suctioning power.
- Use with gas, water, oil, and other non-corrosive liquids

2830513 | \$20<sup>99</sup>

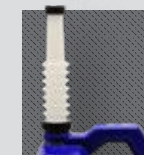

#### FLEX SPOUT

- Convenient easy-pour flex spout fits all Polaris® quart, gallon, and 2.5 gallon bottles

2871285 | \$3<sup>99</sup>



#### PUMP

ATTACHES TO 1 GALLON BOTTLE FOR EASY, NO-DRIP DISPENSING  
2870465 | \$9<sup>99</sup>



### CARBON CLEAN

- Polaris® Carbon Clean prevents ethanol corrosion, stabilizes fuel, and cleans fuel injectors, piston ring lands, intake systems, and combustion chambers. Helps maintain peak HP and improves fuel economy

12 oz. | 2881413



### ADVANCED FUEL TREATMENT

- Advanced Fuel Treatment prevents ethanol corrosion and stabilizes fuel for up to 2 years. Dual-antioxidant formula protects against gum and varnish for easy starting

12 oz. | 2881416  
2.5 gal | 2881417



### ADVANCED FUEL SCENTED TREATMENT

- 1 oz. pouch treats 5 gallons of fuel
- Alcohol free: safe for all powersports applications

Mint | 2881418  
Strawberry | 2881419  
Unscented | 2881420  
25-1 oz. pouches of each formula | 2881421

# LIFT IT SECURELY. LIFT IT SAFELY.

Trying to raise a snowmobile on makeshift stands is never a good idea. The Polaris® Vehicle Lift secures the snowmobile safely, eliminating the risk of the sled toppling while it's being worked on. Work safely, and work smarter.

## POLARIS® VEHICLE LIFT

- Get fast, easy access to the underside of your vehicle
- Manual and pneumatic operation available
- Raises vehicle up to 32" to make repairs & maintenance faster and easier
- Dual-locking safety latch for added safety

1200 LBS  
2830424 | **\$839<sup>99</sup>**  
2300 LBS  
2830425 | **\$1,449<sup>99</sup>**

Maintain your sled without adjusting the lift. You can access your belt, track, hyfax, carbides, skis, engine, and shocks. Work more efficiently and comfortably!

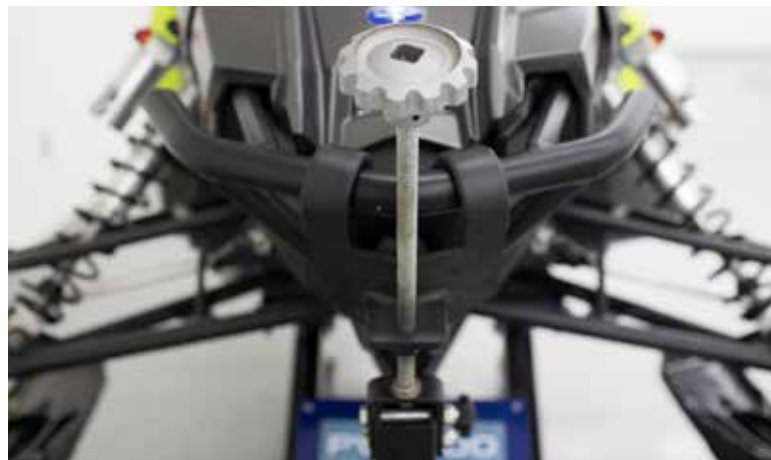
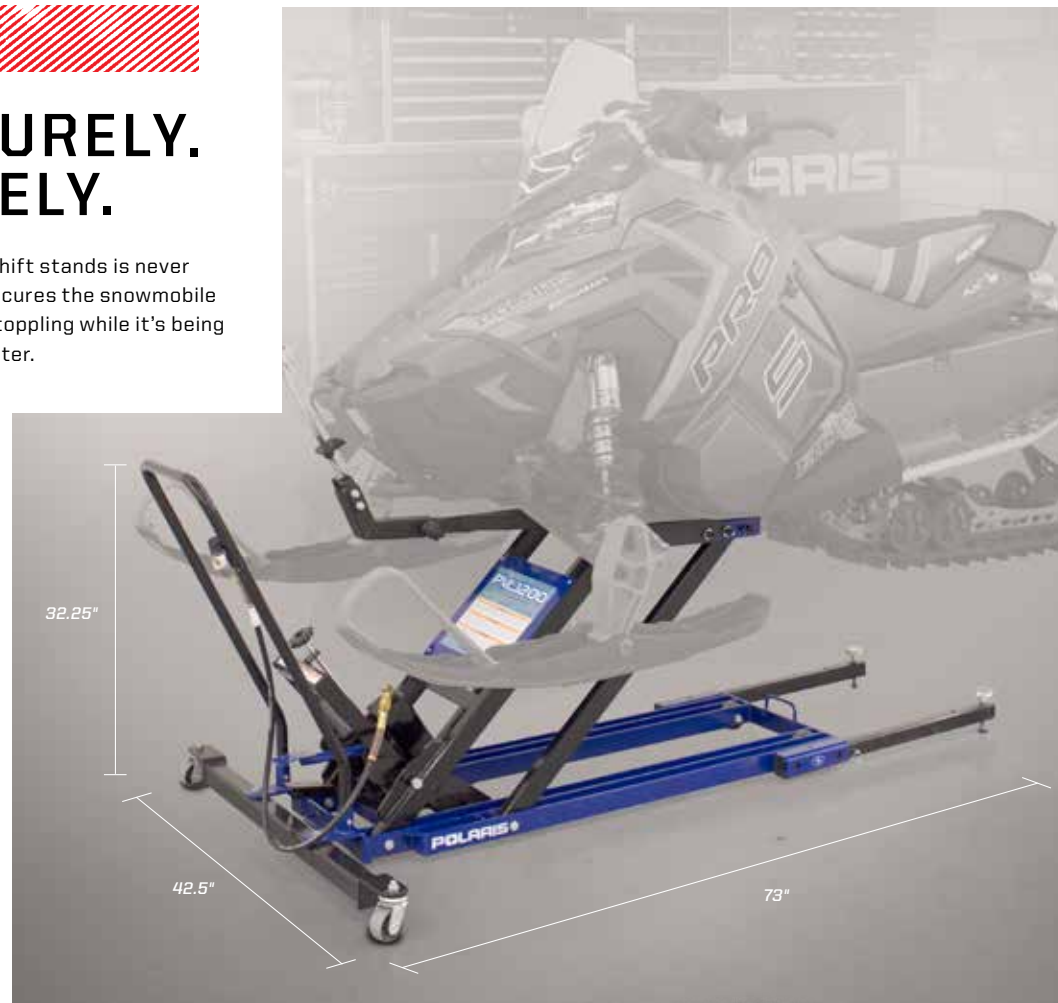

## POLARIS® VEHICLE LIFT ATTACHMENTS

RZR®/Ranger® | 2830428 | **\$279<sup>99</sup>**  
ATV/Polaris® Ace® | 2830427 | **\$199<sup>99</sup>**  
Polaris® Snowmobile | 2830426 | **\$199<sup>99</sup>**



## SNOW DOLLY

- 3" big wheel caster design
  - Move your sled around the garage with ease
- 2882959 | **\$69<sup>99</sup>**



## POLARIS® X3 CREEPER

- Three positions: flat, 45-degree angle, or seated work stool
  - Helps you perform any repair with ease
  - Stay dry and warm away from cold, wet concrete floors
  - Easily stores away when not in use
- Black | 2830429 | **\$179<sup>99</sup>**

KEEP IT CLEAN

## PRE-TREAT

### MUD SHIELD® PRE-TREATMENT

- Inhibits the adhesion of dirt, mud, and snow, making cleaning your vehicle faster and easier
- 16 oz. Aerosol | 2830229 | **\$11<sup>99</sup>**

### NEVER RUST SPRAY®

- Synthetic formula highly resistant to water protects against rust and corrosion while lubricating metal surfaces
- 16 oz. Aerosol | 2830230 | **\$10<sup>99</sup>**

## CLEAN

### XP WASH®

- Foaming, highly-concentrated wash easily removes the most stubborn and intense dirt build-up
- 32 oz. | 2830225 | **\$9<sup>99</sup>**

### XP SPRAY WASH®

- Effortless biodegradable, high-performance wash ideal for removing dirt, oils, and carbon—simply spray on, spray off, and go
- 32 oz. | 2830224 | **\$11<sup>99</sup>**

### ALL-PURPOSE CLEANER

- Professional grade, non-streak, foam formula cuts through grease, dirt, and film, leaving an invisible, dirt-resistant barrier for long-lasting results
- 16 oz. | 2830227 | **\$8<sup>99</sup>**

### GLASS CLEANER

- Heavy-duty foam non-streak formula cuts through grease, dirt, dried bugs, and film, leaving a crystal-clear, dirt-resistant barrier for long-lasting results
- 16 oz. | 2830445 | **\$5<sup>99</sup>**

## SHINE

### POLARIS® POLISH

- Easy protection and shine—spray on, wipe off, and go. For use on painted and plastic surfaces. Contains carnauba wax
- 16 oz. | 2830228 | **\$8<sup>99</sup>**

### INSTANT SHINE & DETAILER

- Spray and wipe formula—cleans, polishes, and protects plastic and painted surfaces
- 16 oz. | 2830226 | **\$7<sup>99</sup>**

## TOWELS

### POLARIS® SHOP TOWELS

64 ct | 2830440 | **\$4<sup>99</sup>**  
200 ct | 2830402 | **\$26<sup>99</sup>**  
200 ct refill | 2830403 | **\$18<sup>99</sup>**

### POLARIS® HEAVY DUTY SCRUBBER WIPES-90CT

2830441 | **\$29<sup>99</sup>**

# BatteryMINDER®

Ensure your vehicle's battery is properly maintained and ready when you need it the most with a BatteryMINDER®.

## BATTERYMINDER® 1510 1.5-AMP

- Ambient temperature sensor with wide operating range ensures the battery will never be overcharged or undercharged
- Extends battery life up to four times when compared to new batteries
- Automatic full-time high frequency (not high voltage) pulse type desulfation
- Reverse polarity, short circuit, and over-temperature protection

2830404 | **\$77<sup>99</sup>**

## BATTERYMINDER® 1.5 AMP CONVERTIBLE

- Two mounting brackets for multiple vehicles/locations
- Fully insulated battery clips and ring terminal assembly for permanent direct-to-battery attachment.
- Maintains up to four batteries at a time
- Attaches to battery while in vehicle or for use on benchtop
- Guaranteed to never under- or overcharge

2830511 | **\$89<sup>99</sup>**

## BATTERYMINDER® 2012 AGM 2-AMP

- Designed for High-Performance Specialty AGM Sealed Batteries
- Guaranteed to never overcharge, regardless of how long connected
- Ambient temperature sensor with wide operating range ensures the battery will never be overcharged or undercharged

2830438 | **\$119<sup>99</sup>**

## BATTERYMINDER® EZ CONNECT

- Allows for quick and easy connecting and disconnecting of your BatteryMINDER®, includes a set of ring terminals

2830411 | **\$39<sup>99</sup>**

## BATTERYMINDER® 12' CABLE

- Made with heavy-duty 16-gauge black zip cord featuring automotive SAE bullet connectors

2830410 | **\$15<sup>99</sup>**

## BATTERYMINDER® SPLITTER

- Connect two batteries simultaneously for easy battery maintenance
- Cap includes a set of ring terminals

2830409 | **\$29<sup>99</sup>**

## BATTERYMINDER® RING TERMINAL

- Features 24" long 18-gauge wire
- Plug has standard 5/16" negative and 3/8" positive terminals
- Replaceable 15-amp in-line fuse for circuit protection

2830437 | **\$11<sup>99</sup>**



## SHOP CLEANERS

### ALL-PURPOSE CLEANER PLUS

- Professional-grade formula removes built-up stains from shop floors, work benches, and other hard surfaces. VOC-free, environmentally-friendly, and biodegradable

1 Gal. | 2830414 | **\$19<sup>99</sup>**  
5 Gal. | 2830416 | **\$69<sup>99</sup>**

### VEHICLE & EQUIPMENT WASH

- Concentrated professional-grade formula powers through vehicle buildup, dirt, and grease with a spot-free rinse. Treat up to 32 gallons. Biodegradable

1 Gal. | 2830417 | **\$19<sup>99</sup>**  
5 Gal. | 2830422 | **\$69<sup>99</sup>**

### HD CLEANER & DEGREASER

- Professional-grade, biodegradable, high-foaming formula dissolves and removes tough stains and soils

1 Gal. | 2830418 | **\$23<sup>99</sup>**  
5 Gal. | 2830420 | **\$95<sup>99</sup>**





**POWERFUL. PORTABLE. DURABLE.**

The ideal solution for portable, quiet power. When you need reliable power far away from an outlet, this generator line delivers. Tested to be tough, these generators are an excellent addition to any trip.



**POLARIS® FLEX JUMPSTARTER**

- 12,000 mAh capacity. Two 5V/2.1A USB outputs, 200-lumen flashlight, and a digital battery life monitor. Includes storage case, smart jumper cables, car charger, wall charger, and user guide. 1-year limited warranty.
- Jumpstart any engine up to 6.4L. The Polaris® Flex Jumpstarter is small enough to be stored in your glovebox and holds its charge so you can count on it when it's needed.

2830495 | **\$143<sup>99</sup>**

**WHICH GENERATOR FITS YOUR NEEDS?**

**1** Add up the running watts of everything you might power at the same time.

**2** Pick the device with the highest running watts and add its starting watts to the previous total.

**3** Select a generator with a slightly higher wattage.

**GENERATOR ACCESSORIES**

	STARTUP WATTAGE	RUNNING WATTAGE
55" LCD TV	0	150
CROCK POT	0	200
RADIO	0	50-200
LAPTOP	0	200-250
625W MICROWAVE	0	625
FRIDGE OR FREEZER	700	700
COFFEE MAKER	1300	800
SUMP PUMP: ½ HP	1300	800
BLENDER	1000	1000
ELECTRIC GRIDDLE	0	1500
7¼" CIRCULAR SAW	1700	1400
AIR CONDITIONER	1500	1500

**POLARIS POWER® INVERTER GENERATORS**



**P1000i**

**1000W**  
PORTABLE / QUIET

- Dual handles and only 36.4 lbs.
- Connect two units together for even more output
- Quieter than casual conversation (54db @ 25%)
- Up to 10 hours on one tank of gas

1000 Watt | P13GDGANA | **\$659<sup>99</sup>**

**P2000i**

**2000W**  
VERSATILE / LIGHTWEIGHT

- Dual handles and only 53.3 lbs.
- Connect two units together for even more output
- Quieter than casual conversation (54db @ 25%)
- Up to 10 hours on 1 gallon of gas

2000 Watt | P13GDGBNA | **\$959<sup>99</sup>**

**P3000iE**

**3000W**  
ROBUST / ELECTRIC START

- Locking 360 degree pivoting wheels.
- Easy electric start for minimal effort
- Quieter than casual conversation (56db @ 25%)
- Up to 21.5 hours on 3.5 gallons of gas

3000 Watt | P13GDGCNA | **\$1,899<sup>99</sup>**



**PARALLEL CABLE KIT**

- Use a parallel cable kit to easily connect two Polaris Power® generators together to increase the total power available

3410281 | **\$169<sup>99</sup>**



**POLARIS POWER® COLD WEATHER KIT**

- Ensure smooth running of your Polaris® Generator in sub-zero temperatures
- Prevents ice blockage in the crankcase breather tube
- Installation required; no need to disconnect for warm weather operation
- Exclusively designed for use with Polaris® P1000i & P2000i inverter generators

2881433 | **\$119<sup>99</sup>**



**POLARIS POWER® GENERATOR OIL**

- Corrosion inhibitors protect against rust and oxidation during long-term storage

1 QUART | 2879383



**POLARIS POWER® TIE-DOWN LEADS**

- Secure your Polaris Power® Generator by inserting the Lock & Ride® Tie Down Leads into the handle
- Secures Lock & Ride® accepting gear
- Safely provides a point for 1" wide tie down strap

2880959 | **\$16<sup>99</sup>**



**POLARIS POWER® GENERATOR STORAGE COVERS**

- Keep your generator looking like new with a strong, durable cover that is resistant to mold, mildew, tears, and abrasions

1000 Watt Cover | 2686441 | **\$34<sup>99</sup>**

2000 Watt Cover | 2686442 | **\$39<sup>99</sup>**

3000 Watt Cover | 2686443 | **\$44<sup>99</sup>**

# TOOL STORAGE SOLUTIONS

## TOUGH. PORTABLE. SECURE.

Inspired by top racing teams, these carts offer the best in storage and organization. Move your tools around the shop with ease, and work on your sled without having to search for the proper tool.



### POLARIS® 30" PORTABLE WORKSTATION

- 30" W x 20" H x 17" D
- Textured Finish | 2830405\*  
**\$859<sup>99</sup>**



### POLARIS® 30" 5-DRAWER ROLLER CABINET

- Raise-and-release drawer pulls keep drawers secure when moving
- Drawers use roller-bearing glides
- Full-width wrap-around aluminum drawer pulls
- 30" W x 41" H x 20" D
- Textured Finish | 2830406\*  
**\$959<sup>99</sup>**



### POLARIS® 41" STANDARD TOP CHEST

- 40" W x 20" H x 19" D
- High-Gloss Finish | 2830450\*  
**\$839<sup>99</sup>**



### POLARIS® 41" PORTABLE WORKSTATION

- 41" W x 21" H x 17" D
- Textured Finish | 2830407\*  
**\$899<sup>99</sup>**



### POLARIS® 41" 11-DRAWER ROLLER CABINET

- Two extra-deep drawers allow storage of large and bulky tools
- 41" W x 41" H x 18" D
- Textured Finish | 2830408\*  
**\$1,229<sup>99</sup>**
- High-Gloss Finish | 2830451\*  
**\$1,199<sup>99</sup>**

\*Tools not included



### TOOL CART

- Rolling design allows for maximum portability
- Multiple-depth drawers securely hold hand tools, power tools, and more
- Large tires for performance in all types of terrain
- Take your tools where you need them easily and securely
- 31" W x 19.125" D x 39" H
- 2830512\* | **\$960<sup>99</sup>**

\*Oil not included



### POLARIS® 72" STAINLESS STEEL TOP

- 72" W x 1" H x 25" D
- 2830496 | **\$499<sup>99</sup>**



### POLARIS® 72" 19-DRAWER ROLLER CABINET

- Three extra-long drawers provide storage for tools of all shapes and sizes
- 72" W x 47" H x 25" D
- High-Gloss Finish | 2830492\*  
**\$3,199<sup>99</sup>**

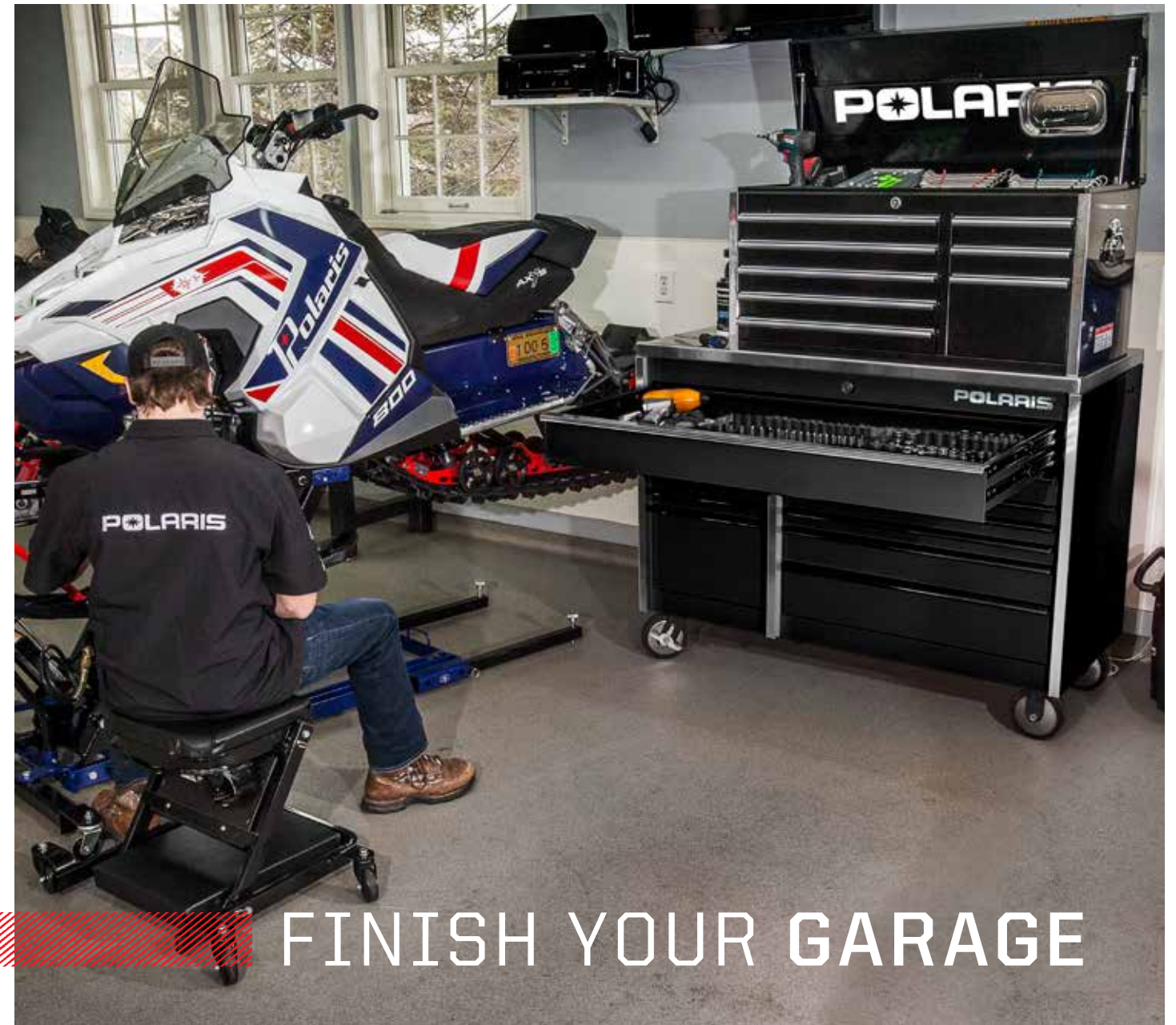

## FINISH YOUR GARAGE



### POLARIS POWER® TOOL CADDY

- Hangs from fence rail of roller tool cabinets
- Silver | 2830430 | **\$74<sup>99</sup>**



### POLARIS® HAND TOOL CADDY

- Silver | 2830431 | **\$79<sup>99</sup>**



### POLARIS® MAGNETIC PARTS TRAY

- Silver | 2830432 | **\$13<sup>99</sup>**



### POLARIS® 33" TELESCOPIC MAGNET

- Black | 2830435 | **\$4<sup>99</sup>**



### POLARIS® 12" HI-TORQUE RATCHETING DRIVER

- Black/Blue | 2830434 | **\$22<sup>99</sup>**



### POLARIS® LED POCKET FLASHLIGHT

- Black | 2830436 | **\$29<sup>99</sup>**